

# LUMOTAST 75 IP40

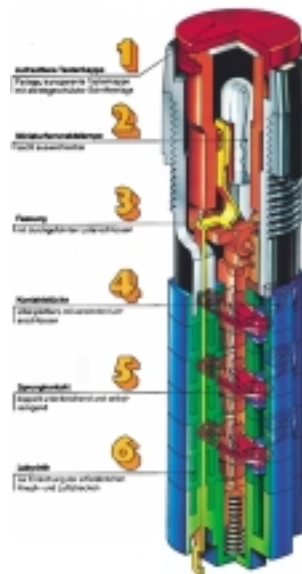

**LUMO  
75 (40)**

## General data

### LUMOTAST 75 IP40 pushbutton range

Illuminated pushbuttons, signal lamps and keylock switches

- Mounting hole diameter 16.2 mm
- Degree of protection IP40
- Solder terminals for the following wire cross-sections:
  - Installed 0.5 mm<sup>2</sup> max.
  - Factory terminated 0.35 mm<sup>2</sup> max.
- 250 V/4 A max.
- 3 NC + 3 NO max.
- Lamp socket T 4.5

## Content

### LUMOTAST 75 illuminated pushbutton IP40

LUMOTAST 75 illuminated pushbutton IP40, protruding lens, round collar	<b>1 - 38</b>
LUMOTAST 75 illuminated pushbutton IP40, flush lens, square collar	1 - 40
LUMOTAST 75 illuminated pushbutton IP40, flush lens, square collar	1 - 41
LUMOTAST 75 illuminated pushbutton IP40, flush lens, rectangular collar	1 - 42
LUMOTAST 75 illuminated pushbutton IP40, protruding lens, square collar	1 - 43

### LUMOTAST 75 keylock switch IP40

LUMOTAST 75 keylock switch IP40, round collar	<b>1 - 44</b>
LUMOTAST 75 keylock switch IP40, round collar	1 - 45
LUMOTAST 75 keylock switch IP40, rectangular collar	1 - 46

### LUMOTAST 75 IP40 signal lamp with lamp socket T 4.5

LUMOTAST 75 IP40 signal lamp with lamp socket T 4.5, round collar, protruding lens	<b>1 - 48</b>
LUMOTAST 75 IP40 signal lamp with lamp socket T 4.5, round collar, protruding lens	1 - 49
LUMOTAST 75 IP40, signal lamp, square collar, flush lens	1 - 50
LUMOTAST 75 IP40 signal lamp, rectangular collar, flush lens	1 - 50
LUMOTAST 75 IP40 signal lamp, square collar, protruding lens	1 - 51

**1 LUMOTAST 75 illuminated pushbutton IP40**

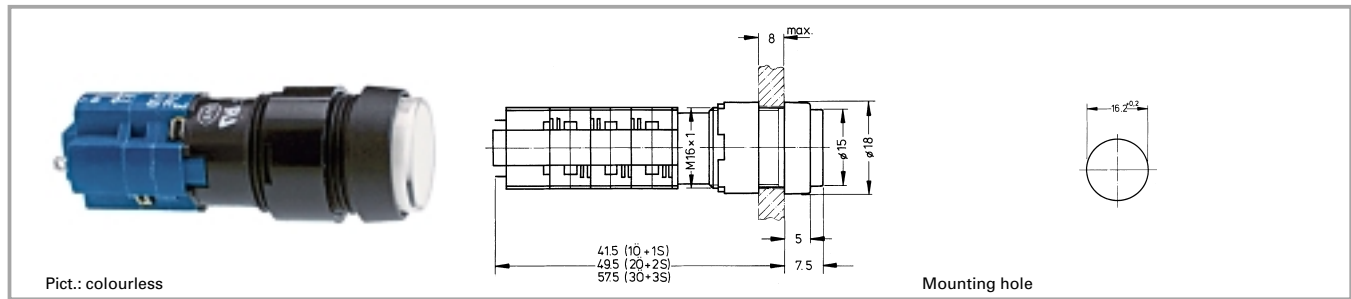

**Technical data**

**LUMO  
75 (40)**

**General information**

Form of lens see order block  
Form of collar see order block  
Colour of collar see order block

**Dimensions**

Length of collar see order block  
Width of collar see order block  
Diameter of collar see order block  
Overall height 7.5 mm  
Mounting depth 41,5/49,5/57,5 mm  
Mounting hole 16.2 mm

**Mechanical design**

Mounting ring nut  
Terminals solder terminals, tin-plated  
Contact system snap-action bridge contact  
Contact function see order block  
Contact arrangement see order block  
Contact materials Ag  
Illuminability yes  
Lamp socket T 4.5

**Mechanical characteristics**

Operating force max. 3 ... 6.5 N  
Operating travel 2.7 mm  
Switching travel NC 1.6 mm  
Switching travel NO 0.9 mm  
Robustness min. 100 N

**Electrical characteristics**

Rated voltage AC max. 250 V  
Rated voltage DC max. 220 V  
Rated voltage AC/DC min. 12 V

Rated current AC max. 4 A  
Rated current DC max. 0.2 A  
Rated current AC/DC min. 5 mA  
Contact resistance acc. to life max. 200 mΩ  
Protection class II

**Other specifications**

Operating life, at 250 V/2 A (operations) 200000 (momentary)  
Operating life, at 250 V/4 A (operations) 60000 (momentary), 10000 (latching)

Degree of protection from front side IP40  
Ambient temp. operating min. -25 °C  
Ambient temp. operating without lamp max. +70 °C  
Ambient temp. operating with lamp max. +55 °C  
Storage temperature min. -40 °C  
Storage temperature max. +80 °C  
Resistance to constant environment according to IEC 600 68-2-3 and 2-30

Resistance at variable environment according to IEC 600 68-2-14 and 2-33

Approvals ENEC 25 T 55 (70), UL, CSA  
V 1







Flame class acc. to UL 94 V 1  
Hot wire ignition acc. to IEC 695-2-1 yes

**Accessories LUMOTAST 75 illuminated pushbutton IP40**

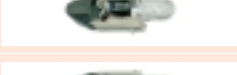
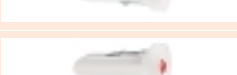
Description	Photo	Order no.	Page
Filament lamp, T 4.5 base, 12 V		<b>1.90.100.022/0000</b>	5 - 6
Filament lamp, T 4.5 base, 24 V		<b>1.90.100.023/0000</b>	5 - 6

## LUMOTAST 75 IP40

### Accessories LUMOTAST 75 illuminated pushbutton IP40

Description	Photo	Order no.	Page
LED T 4.5 superbright, red, 24 V		<b>1.90.690.331/0000</b>	5 - 20
LED T 4.5 superbright, green, 24 V		<b>1.90.690.332/0000</b>	5 - 20
LED T 4.5 superbright, yellow, 24 V		<b>1.90.690.333/0000</b>	5 - 20
LED T 4.5 superbright, blue, 24 V		<b>1.90.690.334/0000</b>	5 - 20
LED T 4.5 superbright, white, 24 V		<b>1.90.690.335/0000</b>	5 - 20
LED T 4.5, red, 3 V		<b>1.90.692.001/0000</b>	5 - 19
LED T 4.5, green, 3 V		<b>1.90.692.002/0000</b>	5 - 19
LED T 4.5, yellow, 3 V		<b>1.90.692.003/0000</b>	5 - 19
Lamp extractor for T 4.5/5.5, lamp diameter 4 mm		<b>1.90.900.002/0000</b>	5 - 24
Lamp extractor for lamp diameter 5-6 mm		<b>1.90.900.004/0000</b>	5 - 24
Protective cap (for 18 x 24 collar)		5.05.800.027/0000	5 - 30
Blanking cap, black, to cover spare holes, dimensions 18 x 18 mm		5.52.006.020/0103	5 - 33
Blanking cap, black, to cover spare holes, dimensions 18 x 24 mm		5.52.006.021/0100	5 - 33
Blanking cap, black, to cover spare holes, round 18 mm		5.52.006.022/0100	5 - 33
Fixing spanner M 15, M 16		<b>5.58.002.019/0105</b>	5 - 25

1

LUMO  
75 (40)

1

**LUMOTAST 75 illuminated pushbutton IP40, protruding lens, round collar**



Pict.: colourless

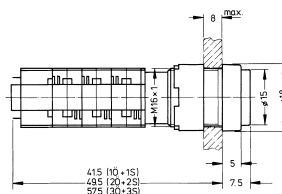

Mounting hole



LUMO  
75 (40)

Contact arrangement	Contact function	Colour of collar	Order no. without lens	Note
1 NC + 1 NO	momentary	black	<b>1.15.108.451/0000</b>	Please include the desired lens and diffuser in your order.
1 NC + 1 NO	latching	black	<b>1.15.108.551/0000</b>	Please include the desired lens and diffuser in your order.
2 NC + 2 NO	momentary	black	1.15.108.452/0000	Please include the desired lens and diffuser in your order.
2 NC + 2 NO	latching	black	1.15.108.552/0000	Please include the desired lens and diffuser in your order.
3 NC + 3 NO	momentary	black	1.15.108.453/0000	Please include the desired lens and diffuser in your order.
3 NC + 3 NO	latching	black	1.15.108.553/0000	Please include the desired lens and diffuser in your order.

Technical data see page 1 - 38

Lens, round, transparent colourless, for filament lamp or LED: **5.49.257.011/1002**

Lens, round, transparent red, for LED: **5.49.257.011/1301**

Lens, round, transparent red, for filament lamp: **5.49.257.011/1303**

Lens, round, transparent yellow, for filament lamp or LED: **5.49.257.011/1402**

Lens, round, transparent green, for filament lamp: **5.49.257.011/1502**

Lens, round, transparent green, for LED: **5.49.257.011/1503**

Lens, round, transparent blue, for filament lamp: **5.49.257.011/1601**

**Accessories:**

Diffuser, round, for filament lamp, without legend: **5.72.050.000/0202**

Diffuser, round, for LED, without legend: **5.72.050.000/0214**

## LUMOTAST 75 IP40

### LUMOTAST 75 illuminated pushbutton IP40, flush lens, square collar



Pict.: red, without ring nut

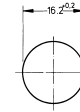
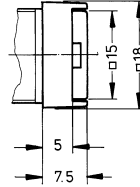

Mounting hole

Contact arrangement	Contact function	Colour of collar	Order no. without lens	Note
1 NC + 1 NO	momentary	black	<b>1.15.108.251/0000</b>	Please include the desired lens and diffuser in your order.
1 NC + 1 NO	latching	black	<b>1.15.108.351/0000</b>	Please include the desired lens and diffuser in your order.
2 NC + 2 NO	momentary	black	1.15.108.252/0000	Please include the desired lens and diffuser in your order.
2 NC + 2 NO	latching	black	1.15.108.352/0000	Please include the desired lens and diffuser in your order.
3 NC + 3 NO	momentary	black	1.15.108.253/0000	Please include the desired lens and diffuser in your order.
3 NC + 3 NO	latching	black	1.15.108.353/0000	Please include the desired lens and diffuser in your order.

**LUMO  
75 (40)**

Technical data see page 1 - 38

Lens, square, transparent colourless, for filament lamp or LED: **5.49.275.036/1002**

Lens, square, transparent red, for LED: **5.49.275.036/1301**

Lens, square, transparent red, for filament lamp: **5.49.275.036/1303**

Lens, square, transparent yellow, for filament lamp or LED: **5.49.275.036/1402**

Lens, square, transparent green, for filament lamp: **5.49.275.036/1502**

Lens, square, transparent green, for LED: **5.49.275.036/1503**

Lens, square, transparent blue, for filament lamp: **5.49.275.036/1601**

#### Accessories:

Sealing cap IP65 (for 18 x 18 collar): 5.05.200.009/0000

Protective cap (for 18 x 18 collar): 5.05.800.030/0000

Diffuser, square, for filament lamp, without legend: **5.73.013.000/0202**

Diffuser, square, for LED, without legend: **5.73.013.000/0214**

1

**LUMOTAST 75 illuminated pushbutton IP40, flush lens, rectangular collar**



Pict.: green

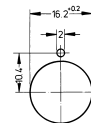
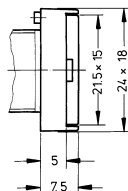

LUMO  
75 (40)

Contact arrangement	Contact function	Colour of collar	Order no. without lens	Note
1 NC + 1 NO	momentary	black	<b>1.15.108.051/0000</b>	Please include the desired lens and diffuser in your order.
1 NC + 1 NO	latching	black	<b>1.15.108.151/0000</b>	Please include the desired lens and diffuser in your order.
2 NC + 2 NO	momentary	black	1.15.108.052/0000	Please include the desired lens and diffuser in your order.
2 NC + 2 NO	latching	black	1.15.108.152/0000	Please include the desired lens and diffuser in your order.
3 NC + 3 NO	momentary	black	1.15.108.053/0000	Please include the desired lens and diffuser in your order.
3 NC + 3 NO	latching	black	1.15.108.153/0000	Please include the desired lens and diffuser in your order.

Technical data see page 1 - 38

Lens, rectangular, transparent colourless, for filament lamp or LED: **5.49.275.032/1002**

Lens, rectangular, transparent red, for LED: **5.49.275.032/1301**

Lens, rectangular, transparent red, for filament lamp: **5.49.275.032/1303**

Lens, rectangular, transparent yellow, for filament lamp or LED: **5.49.275.032/1402**

Lens, rectangular, transparent green, for filament lamp: **5.49.275.032/1502**

Lens, rectangular, transparent green, for LED: **5.49.275.032/1503**

Lens, rectangular, transparent blue, for filament lamp: **5.49.275.032/1601**

**Accessories:**

Sealing cap IP65 (for 18 x 24 collar): 5.05.200.008/0000

Protective cap (for 18 x 24 collar): 5.05.800.027/0000

Diffuser, rectangular, for filament lamp, without legend: **5.73.012.000/0202**

Diffuser, rectangular, for LED, without legend: **5.73.012.000/0214**

## LUMOTAST 75 IP40

### LUMOTAST 75 illuminated pushbutton IP40, protruding lens, square collar

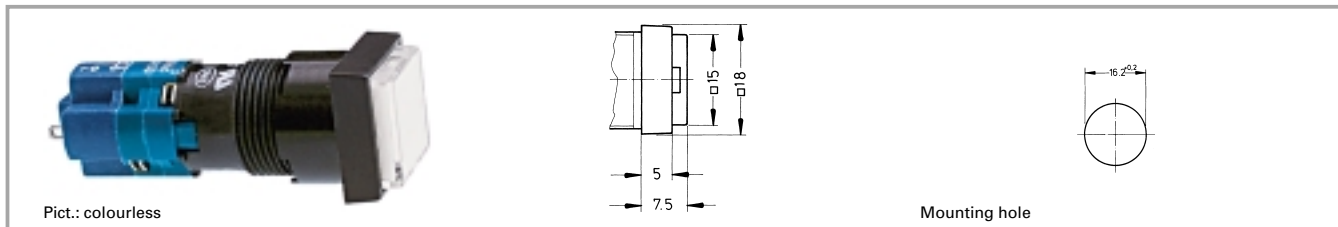

Contact arrangement	Contact function	Colour of collar	Order no. without lens	Note
1 NC + 1 NO	momentary	black	1.15.108.256/0000	Please include the desired lens and diffuser in your order.
1 NC + 1 NO	latching	black	1.15.108.356/0000	Please include the desired lens and diffuser in your order.
2 NC + 2 NO	momentary	black	1.15.108.257/0000	Please include the desired lens and diffuser in your order.
2 NC + 2 NO	latching	black	1.15.108.357/0000	Please include the desired lens and diffuser in your order.
3 NC + 3 NO	momentary	black	1.15.108.258/0000	Please include the desired lens and diffuser in your order.
3 NC + 3 NO	latching	black	1.15.108.358/0000	Please include the desired lens and diffuser in your order.

Technical data see page 1 - 38

Lens, square, transparent colourless, for filament lamp or LED: **5.49.275.036/1002**

Lens, square, transparent red, for LED: **5.49.275.036/1301**

Lens, square, transparent red, for filament lamp: **5.49.275.036/1303**

Lens, square, transparent yellow, for filament lamp or LED: **5.49.275.036/1402**

Lens, square, transparent green, for filament lamp: **5.49.275.036/1502**

Lens, square, transparent green, for LED: **5.49.275.036/1503**

Lens, square, transparent blue, for filament lamp: **5.49.275.036/1601**

#### Accessories:

Sealing cap IP65 (for 18 x 18 collar): 5.05.200.009/0000

Protective cap (for 18 x 18 collar): 5.05.800.030/0000

Diffuser, square, for filament lamp, without legend: **5.73.013.000/0202**

Diffuser, square, for LED, without legend: **5.73.013.000/0214**

# 1

**LUMO  
75 (40)**

**1**

**LUMOTAST 75 keylock switch IP40**



Mounting hole

**Technical data**

**LUMO  
75 (40)**

**General information**

Form of lens see order block  
Colour of collar see order block  
Form of collar see order block

**Dimensions**

Length of collar see order block  
Diameter of collar see order block  
Width of collar see order block  
Overall height (without key) 7.5 mm  
Mounting depth see order block  
Mounting hole 16.2 mm

**Mechanical design**

Mounting ring nut  
Terminals solder terminals, tin-plated  
Contact system snap-action bridge contact  
Contact function see order block  
Contact arrangement see order block  
Contact materials Ag  
Illuminability no  
Lock cylinder lock  
Wafers 4 pins  
Lock type 1D 21  
Number of locking positions 45  
Main key no  
Symmetric key no  
Key removal position see order block

**Mechanical characteristics**

Rotating angle see order block

**Electrical characteristics**

Rated voltage AC max. 250 V  
Rated voltage DC max. 220 V  
Rated voltage AC/DC min. 12 V  
Rated current AC max. 4 A  
Rated current DC max. 0.02 A  
Rated current AC/DC min. 5 mA  
Contact resistance acc. to life max. 200 mΩ  
Bouncing time max. 10 ms  
ESD-strength min. 14 kV

**Other specifications**

Operating life, at 250 V/2 A (operations) 50000 (momentary)  
Operating life, at 250 V/4 A (operations) 50000 (momentary)  
Degree of protection from front side IP40  
Ambient temp. operating min. -25 °C  
Ambient temp. operating max. +70 °C  
Storage temperature min. -40 °C  
Storage temperature max. +80 °C  
Resistance to constant environment according to IEC 600 68-2-3 and 2-30  
Resistance at variable environment according to IEC 600 68-2-14 and 2-33  
Weight max. 35 g  
Approvals ENEC 25 T 55 (70), UL, CSA  
Flame class acc. to UL 94 V 1  
Hot wire ignition acc. to IEC 695-2-1 yes

**Accessories LUMOTAST 75 keylock switch IP40**

Description	Photo	Order no.	Page
Blanking cap, black, to cover spare holes, dimensions 18 x 24 mm		5.52.006.021/0100	5 - 33
Blanking cap, black, to cover spare holes, round 18 mm		5.52.006.022/0100	5 - 33



# LUMOTAST 75 IP40

## Accessories LUMOTAST 75 keylock switch IP40



Description	Photo	Order no.	Page
Fixing spanner M 15, M 16		<b>5.58.002.019/0105</b>	5 - 25
Spare key for LUMO 75		5.58.002.030/0000	
Key cap for LUMO 75		5.58.004.721/0000	

1

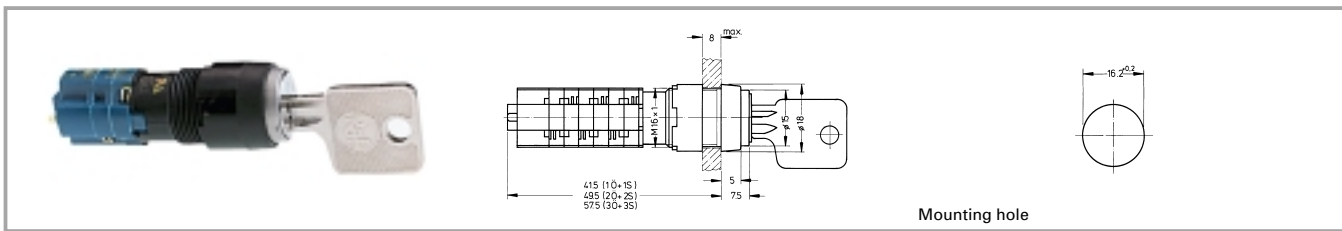
## LUMOTAST 75 keylock switch IP40, round collar

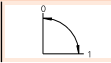
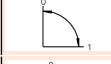
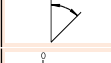
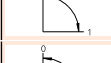

LUMO  
75 (40)

Contact arrangement	Contact function	Rotating angle	Key removal position	Colour of collar	Order no. complete
1 NC + 1 NO	latching	90°		black	<b>1.15.108.851/0000</b>
1 NC + 1 NO	latching	90°		black	1.15.108.911/0000
1 NC + 1 NO	momentary	45°		black	1.15.108.941/0000
2 NC + 2 NO	latching	90°		black	1.15.108.852/0000
2 NC + 2 NO	latching	90°		black	1.15.108.912/0000

Technical data see page 1 - 44

Included: 2 keys.  
Other lock variants and contacts available on request.

1

**LUMOTAST 75 keylock switch IP40, rectangular collar**

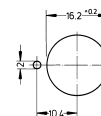
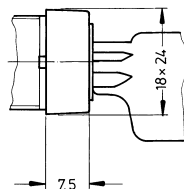

Panel cut-out

LUMO  
75 (40)

Contact arrangement	Contact function	Rotating angle		Key removal position	Colour of collar	Order no. complete
1 NC + 1 NO	latching	90°		0	black	<b>1.15.108.571/0100</b>
1 NC + 1 NO	latching	90°		0+1	black	<b>1.15.108.631/0100</b>
1 NC + 1 NO	momentary	45°		0	black	1.15.108.661/0100
2 NC + 2 NO	latching	90°		0	black	<b>1.15.108.572/0100</b>
2 NC + 2 NO	latching	90°		0+1	black	<b>1.15.108.632/0100</b>

Technical data see page 1 - 44

Included: 2 keys.

Other lock variants and contacts available on request.

**1**

**LUMOTAST 75 IP40 signal lamp with lamp socket T 4.5**



Pict.: blue

Mounting hole

**Technical data**

LUMO  
75 (40)

**General information**

Form of lens see order block  
Form of collar see order block  
Colour of collar see order block

**Dimensions**

Length of collar see order block  
Width of collar see order block  
Diameter of collar see order block  
Overall height 7.5 mm  
Mounting depth 33.5 mm  
Mounting hole 16.2 mm

**Mechanical design**

Mounting ring nut  
Terminals solder terminals, tin-plated  
Lamp socket T 4.5  
Lamp filament lamp / LED

**Electrical characteristics**

Voltage limit max. 42 V  
Power limit max. 1.2 W

**Other specifications**

Degree of protection from front side IP40  
Weight 5 g  
Approvals ENEC 25 T 55 (70), UL, CSA  
Ambient temp. operating min. -25 °C  
Ambient temp. operating max. +55 °C  
Storage temperature min. -40 °C  
Storage temperature max. +80 °C  
Resistance to constant environment according to IEC 600 68-2-3 and 2-30  
Resistance at variable environment according to IEC 600 68-2-14 and 2-33

**Accessories LUMOTAST 75 IP40 signal lamp with lamp socket T 4.5**

Description	Photo	Order no.	Page
Filament lamp, T 4.5 base, 12 V		<b>1.90.100.022/0000</b>	5 - 6
Filament lamp, T 4.5 base, 24 V		<b>1.90.100.023/0000</b>	5 - 6
LED T 4.5 superbright, red, 24 V		<b>1.90.690.331/0000</b>	5 - 20
LED T 4.5 superbright, green, 24 V		<b>1.90.690.332/0000</b>	5 - 20
LED T 4.5 superbright, yellow, 24 V		<b>1.90.690.333/0000</b>	5 - 20
LED T 4.5 superbright, blue, 24 V		<b>1.90.690.334/0000</b>	5 - 20
LED T 4.5 superbright, white, 24 V		<b>1.90.690.335/0000</b>	5 - 20

## LUMOTAST 75 IP40

### Accessories LUMOTAST 75 IP40 signal lamp with lamp socket T 4.5

Description	Photo	Order no.	Page
LED T 4.5, red, 3 V		<b>1.90.692.001/0000</b>	5 - 19
LED T 4.5, green, 3 V		<b>1.90.692.002/0000</b>	5 - 19
LED T 4.5, yellow, 3 V		<b>1.90.692.003/0000</b>	5 - 19
Blanking cap, black, to cover spare holes, dimensions 18 x 18 mm		5.52.006.020/0103	5 - 33
Blanking cap, black, to cover spare holes, dimensions 18 x 24 mm		5.52.006.021/0100	5 - 33
Blanking cap, black, to cover spare holes, round 18 mm		5.52.006.022/0100	5 - 33
Fixing spanner M 15, M 16		<b>5.58.002.019/0105</b>	5 - 25

1

LUMO  
75 (40)

### LUMOTAST 75 IP40 signal lamp with lamp socket T 4.5, round collar, protruding lens

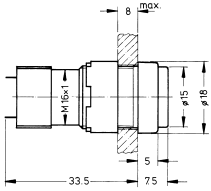
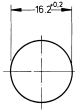
					
Pict.: blue		Mounting hole			
Voltage limit max.	Power limit max.	Lamp socket	Colour of collar	Order no. without lens	Note
42 V	1.2 W	T 4.5	black	<b>1.65.111.071/0000</b>	Please include the desired lens and diffuser in your order.

Technical data see page 1 - 48

Lens, round, transparent colourless, for filament lamp or LED: **5.49.257.011/1002**

Lens, round, transparent red, for LED: **5.49.257.011/1301**

Lens, round, transparent red, for filament lamp: **5.49.257.011/1303**

Lens, round, transparent yellow, for filament lamp or LED: **5.49.257.011/1402**

Lens, round, transparent green, for filament lamp: **5.49.257.011/1502**

Lens, round, transparent green, for LED: **5.49.257.011/1503**

Lens, round, transparent blue, for filament lamp: **5.49.257.011/1601**

#### Accessories:

Diffuser, round, for filament lamp, without legend: **5.72.050.000/0202**

Diffuser, round, for LED, without legend: **5.72.050.000/0214**

1

**LUMOTAST 75 IP40, signal lamp, square collar, flush lens**

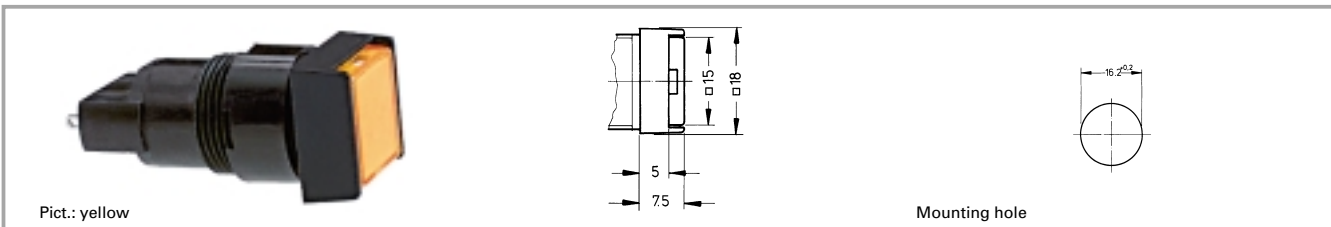

Voltage limit max.	Power limit max.	Lamp socket	Colour of collar	Order no. without lens	Note
42 V	1.2 W	T 4.5	black	<b>1.65.111.061/0000</b>	Please include the desired lens and diffuser in your order.

Technical data see page 1 - 48

LUMO  
75 (40)

- Lens, square, transparent colourless, for filament lamp or LED: **5.49.275.036/1002**
- Lens, square, transparent red, for LED: **5.49.275.036/1301**
- Lens, square, transparent red, for filament lamp: **5.49.275.036/1303**
- Lens, square, transparent yellow, for filament lamp or LED: **5.49.275.036/1402**
- Lens, square, transparent green, for filament lamp: **5.49.275.036/1502**
- Lens, square, transparent green, for LED: **5.49.275.036/1503**
- Lens, square, transparent blue, for filament lamp: **5.49.275.036/1601**

**Accessories:**

- Diffuser, square, for filament lamp, without legend: **5.73.013.000/0202**
- Diffuser, square, for LED, without legend: **5.73.013.000/0214**

**LUMOTAST 75 IP40 signal lamp, rectangular collar, flush lens**

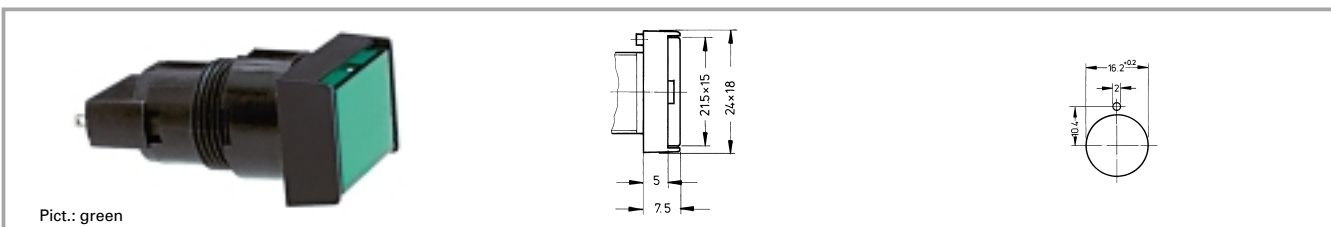

Voltage limit max.	Power limit max.	Lamp socket	Colour of collar	Order no. without lens	Note
42 V	1.2 W	T 4.5	black	<b>1.65.111.051/0000</b>	Please include the desired lens and diffuser in your order.

Technical data see page 1 - 48

- Lens, rectangular, transparent colourless, for filament lamp or LED: **5.49.275.032/1002**
- Lens, rectangular, transparent red, for LED: **5.49.275.032/1301**
- Lens, rectangular, transparent red, for filament lamp: **5.49.275.032/1303**
- Lens, rectangular, transparent yellow, for filament lamp or LED: **5.49.275.032/1402**
- Lens, rectangular, transparent green, for filament lamp: **5.49.275.032/1502**
- Lens, rectangular, transparent green, for LED: **5.49.275.032/1503**
- Lens, rectangular, transparent blue, for filament lamp: **5.49.275.032/1601**

**Accessories:**

- Diffuser, rectangular, for filament lamp, without legend: **5.73.012.000/0202**
- Diffuser, rectangular, for LED, without legend: **5.73.012.000/0214**

## LUMOTAST 75 IP40

### LUMOTAST 75 IP40 signal lamp, square collar, protruding lens

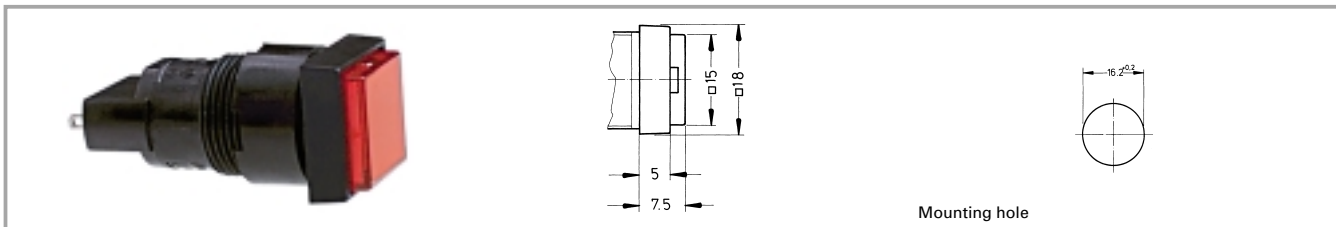

Voltage limit max.	Power limit max.	Lamp socket	Colour of collar	Order no. without lens	Note
42 V	1.2 W	T 4.5	black	1.65.111.081/0000	Please include the desired lens and diffuser in your order.

Technical data see page 1 - 48

Lens, square, transparent colourless, for filament lamp or LED: **5.49.275.036/1002**

Lens, square, transparent red, for LED: **5.49.275.036/1301**

Lens, square, transparent red, for filament lamp: **5.49.275.036/1303**

Lens, square, transparent yellow, for filament lamp or LED: **5.49.275.036/1402**

Lens, square, transparent green, for filament lamp: **5.49.275.036/1502**

Lens, square, transparent green, for LED: **5.49.275.036/1503**

Lens, square, transparent blue, for filament lamp: **5.49.275.036/1601**

#### Accessories:

Diffuser, square, for filament lamp, without legend: **5.73.013.000/0202**

Diffuser, square, for LED, without legend: **5.73.013.000/0214**

# 1

**LUMO  
75 (40)**

# LUMOTAST 75 IP65

1

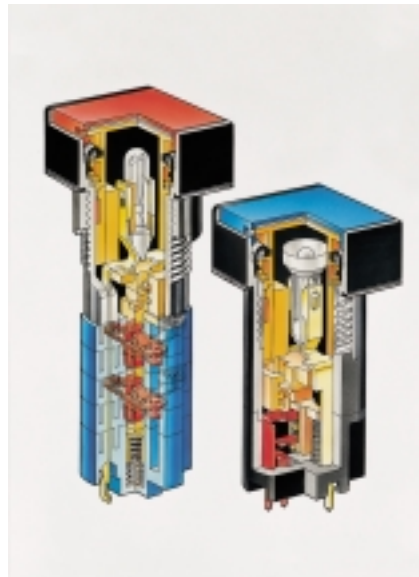

## General data

LUMO  
75 (65)

### LUMOTAST 75 IP65 pushbutton range

Illuminated pushbuttons and signal lamps with lamp socket T 4.5

- Mounting hole diameter 16.2 mm
- Degree of protection IP65
- Solder terminals for the following wire cross-sections:
  - Installed 0.5 mm<sup>2</sup> max.
  - Factory terminated 0.35 mm<sup>2</sup> max.
- 250 V/4 A max.
- 3 NC + 3 NO max.

## Content

### LUMOTAST 75 illuminated pushbutton IP65

LUMOTAST 75 illuminated pushbutton IP65, flush lens, square collar	<b>1 - 54</b>
LUMOTAST 75 illuminated pushbutton IP65, protruding lens, square collar	1 - 56
LUMOTAST 75 illuminated pushbutton IP65, protruding lens, square collar	1 - 57
LUMOTAST 75 illuminated pushbutton IP65, flush lens, round collar	1 - 58
LUMOTAST 75 illuminated pushbutton IP65, protruding lens, round collar	1 - 59
LUMOTAST 75 illuminated pushbutton IP65, flush lens, rectangular collar	1 - 60

### LUMOTAST 75 signal lamp IP65

LUMOTAST 75 signal lamp IP65, flush lens, square collar	<b>1 - 62</b>
LUMOTAST 75 signal lamp IP65, flush lens, square collar	1 - 63
LUMOTAST 75 signal lamp IP65, protruding lens, square collar	1 - 64
LUMOTAST 75 signal lamp IP65, flush lens, round collar	1 - 64
LUMOTAST 75 signal lamp IP65, protruding lens, round collar	1 - 65
LUMOTAST 75 signal lamp IP65, flush lens, rectangular collar	1 - 65

**1**

**LUMOTAST 75 illuminated pushbutton IP65**

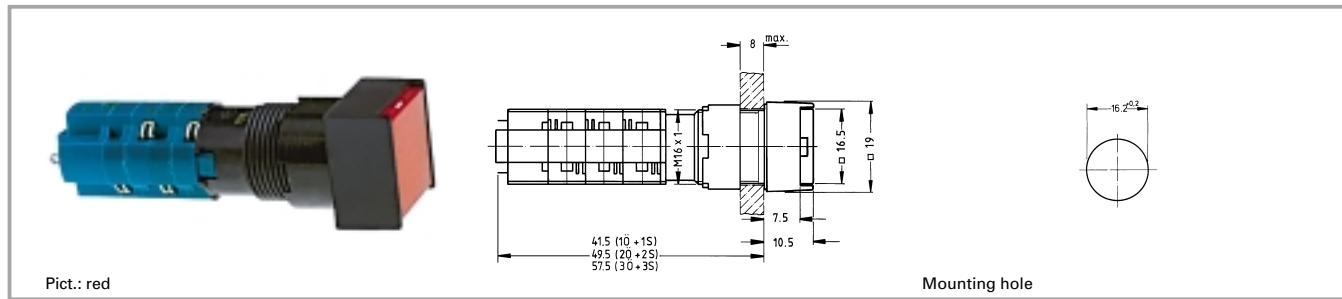

**Technical data**

**General information**

Form of lens see order block  
 Colour of lens see order block  
 Form of collar see order block  
 Colour of collar black

**Dimensions**

Length of collar see order block  
 Diameter of collar see order block  
 Width of collar see order block  
 Overall height 10.5 mm  
 Mounting depth see order block  
 Mounting hole 16.2 mm

**Mechanical design**

Mounting ring nut  
 Terminals solder terminals, tin-plated  
 Contact system snap-action bridge contact  
 Contact function see order block  
 Contact arrangement see order block  
 Contact materials Ag  
 Illuminability yes  
 Lamp socket T 4.5

**Mechanical characteristics**

Operating force 3 ... 6.5 N  
 Operating travel 2.5 mm  
 Switching travel NC 1.8 mm  
 Switching travel NO 0.9 mm  
 Robustness min. 100 N

**Electrical characteristics**

Rated voltage AC max. 250 V  
 Rated voltage DC max. 220 V  
 Rated voltage AC/DC min. 12 V

Rated current AC max. 4 A  
 Rated current DC max. 0.2 A  
 Rated current AC/DC min. 5 mA  
 Contact resistance acc. to life max. 200 mΩ  
 Protection class II  
 ESD-strength min. 14 kV

**Other specifications**

Operating life, at 250 V/2 A (operations) 200000 (momentary), 50000 (latching)  
 Operating life, at 250 V/4 A (operations) 60000 (momentary)  
 Degree of protection from front side IP65  
 Ambient temp. operating min. -25 °C  
 Ambient temp. operating without lamp max. +70 °C  
 Ambient temp. operating with lamp max. +55 °C  
 Storage temperature min. -40 °C  
 Storage temperature max. +80 °C  
 Resistance to constant environment according to IEC 600 68-2-3 and 2-30  
 Resistance at variable environment according to IEC 600 68-2-14 and 2-33  
 Weight 15 g  
 Approvals ENEC 25 T 55 (70), UL, CSA  
 Flame class acc. to UL 94 V 0  
 Hot wire ignition acc. to IEC 695-2-1 yes

LUMO  
75 (65)









**Accessories LUMOTAST 75 illuminated pushbutton IP65**

Description	Photo	Order no.	Page
Filament lamp, T 4.5 base, 12 V		<b>1.90.100.022/0000</b>	5 - 6
Filament lamp, T 4.5 base, 24 V		<b>1.90.100.023/0000</b>	5 - 6

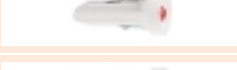
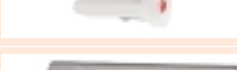
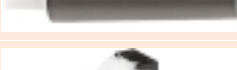

## LUMOTAST 75 IP65

### Accessories LUMOTAST 75 illuminated pushbutton IP65

Description	Photo	Order no.	Page
LED T 4.5 superbright, red, 24 V		<b>1.90.690.331/0000</b>	5 - 20
LED T 4.5 superbright, green, 24 V		<b>1.90.690.332/0000</b>	5 - 20
LED T 4.5 superbright, yellow, 24 V		<b>1.90.690.333/0000</b>	5 - 20
LED T 4.5 superbright, blue, 24 V		<b>1.90.690.334/0000</b>	5 - 20
LED T 4.5 superbright, white, 24 V		<b>1.90.690.335/0000</b>	5 - 20
LED T 4.5, red, 3 V		<b>1.90.692.001/0000</b>	5 - 19
LED T 4.5, green, 3 V		<b>1.90.692.002/0000</b>	5 - 19
LED T 4.5, yellow, 3 V		<b>1.90.692.003/0000</b>	5 - 19
Lamp extractor for T 4.5/5.5, lamp diameter 4 mm		<b>1.90.900.002/0000</b>	5 - 24
Lamp extractor for lamp diameter 5-6 mm		<b>1.90.900.004/0000</b>	5 - 24
Protective cap (for 18 x 24 collar)		5.05.800.027/0000	5 - 30
Blanking cap, black, to cover spare holes, dimensions 18 x 18 mm		5.52.006.020/0103	5 - 33
Blanking cap, black, to cover spare holes, dimensions 18 x 24 mm		5.52.006.021/0100	5 - 33
Blanking cap, black, to cover spare holes, round 18 mm		5.52.006.022/0100	5 - 33
Fixing spanner M 15, M 16		<b>5.58.002.019/0105</b>	5 - 25

1

LUMO  
75 (65)

1

**LUMOTAST 75 illuminated pushbutton IP65, flush lens, square collar**

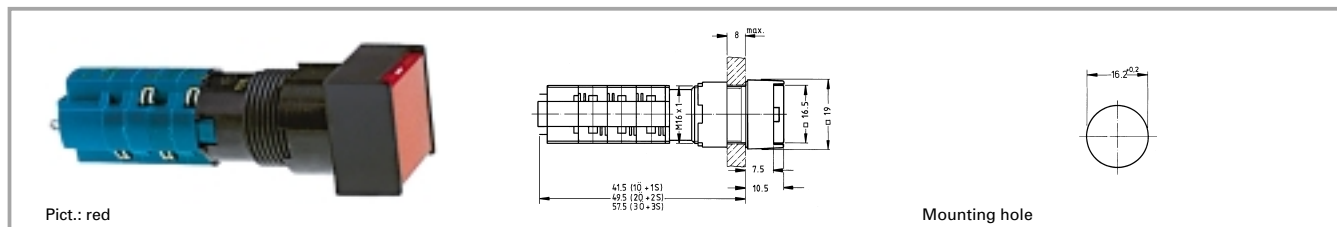

Contact arrangement	Contact function	Colour of collar	Order no. without lens	Note
1 NC + 1 NO	momentary	black	<b>1.15.108.276/0000</b>	Please include the desired lens in your order.
1 NC + 1 NO	latching	black	1.15.108.376/0000	Please include the desired lens in your order.
2 NC + 2 NO	momentary	black	1.15.108.277/0000	Please include the desired lens in your order.
2 NC + 2 NO	latching	black	1.15.108.377/0000	Please include the desired lens in your order.
3 NC + 3 NO	momentary	black	1.15.108.278/0000	Please include the desired lens in your order.
3 NC + 3 NO	latching	black	1.15.108.378/0000	Please include the desired lens in your order.

**LUMO  
75 (65)**

Technical data see page 1 - 54

- Lens, square, transparent colourless, for filament lamp or LED: **5.49.277.052/1002**
- Lens, square, transparent red, for LED: **5.49.277.052/1301**
- Lens, square, transparent red, for filament lamp: **5.49.277.052/1303**
- Lens, square, transparent yellow, for filament lamp or LED: **5.49.277.052/1402**
- Lens, square, transparent green, for filament lamp: **5.49.277.052/1502**
- Lens, square, transparent green, for LED: **5.49.277.052/1503**
- Lens, square, transparent blue, for filament lamp: **5.49.277.052/1601**

**Accessories:**

Legend insert, square, without legend: 5.70.629.000/2000

## LUMOTAST 75 IP65

### LUMOTAST 75 illuminated pushbutton IP65, protruding lens, square collar

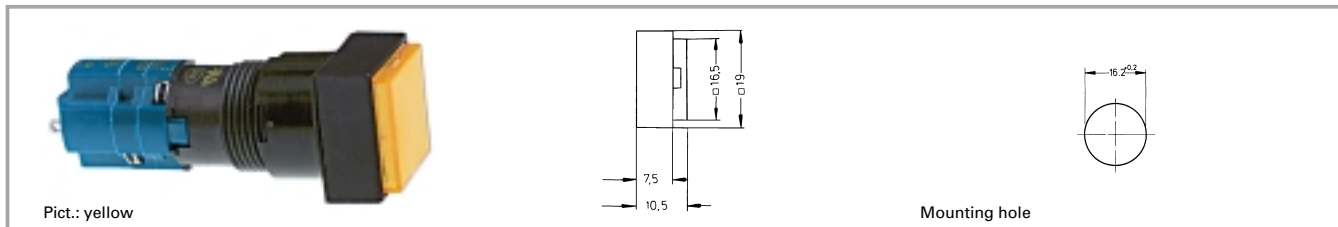

Contact arrangement	Contact function	Colour of collar	Order no. without lens	Note
1 NC + 1 NO	momentary	black	1.15.108.281/0000	Please include the desired lens in your order.
1 NC + 1 NO	latching	black	1.15.108.381/0000	Please include the desired lens in your order.
2 NC + 2 NO	momentary	black	1.15.108.282/0000	Please include the desired lens in your order.
2 NC + 2 NO	latching	black	1.15.108.382/0000	Please include the desired lens in your order.
3 NC + 3 NO	momentary	black	1.15.108.283/0000	Please include the desired lens in your order.
3 NC + 3 NO	latching	black	1.15.108.383/0000	Please include the desired lens in your order.

**LUMO  
75 (65)**

Technical data see page 1 - 54

Lens, square, transparent colourless, for filament lamp or LED: **5.49.277.052/1002**

Lens, square, transparent red, for LED: **5.49.277.052/1301**

Lens, square, transparent red, for filament lamp: **5.49.277.052/1303**

Lens, square, transparent yellow, for filament lamp or LED: **5.49.277.052/1402**

Lens, square, transparent green, for filament lamp: **5.49.277.052/1502**

Lens, square, transparent green, for LED: **5.49.277.052/1503**

Lens, square, transparent blue, for filament lamp: **5.49.277.052/1601**

#### Accessories:

Legend insert, square, without legend: 5.70.629.000/2000

1

**LUMOTAST 75 illuminated pushbutton IP65, flush lens, round collar**



Pict.: blue

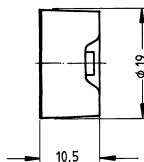

Mounting hole

Contact arrangement	Contact function	Colour of collar	Order no. without lens	Note
1 NC + 1 NO	momentary	black	<b>1.15.108.481/0000</b>	Please include the desired lens in your order.
1 NC + 1 NO	latching	black	1.15.108.981/0000	Please include the desired lens in your order.
2 NC + 2 NO	momentary	black	1.15.108.482/0000	Please include the desired lens in your order.
2 NC + 2 NO	latching	black	1.15.108.982/0000	Please include the desired lens in your order.
3 NC + 3 NO	momentary	black	1.15.108.483/0000	Please include the desired lens in your order.
3 NC + 3 NO	latching	black	1.15.108.983/0000	Please include the desired lens in your order.

LUMO  
75 (65)

Technical data see page 1 - 54

Lens, round, transparent colourless, for filament lamp or LED: **5.49.259.013/1002**

Lens, round, transparent red, for LED: **5.49.259.013/1301**

Lens, round, transparent red, for filament lamp: **5.49.259.013/1303**

Lens, round, transparent yellow, for filament lamp or LED: **5.49.259.013/1402**

Lens, round, transparent green, for filament lamp: **5.49.259.013/1502**

Lens, round, transparent green, for LED: **5.49.259.013/1503**

Lens, round, transparent blue, for filament lamp: **5.49.259.013/1601**

**Accessories:**

Legend insert, round, without legend: 5.70.059.000/2000

## LUMOTAST 75 IP65

### LUMOTAST 75 illuminated pushbutton IP65, protruding lens, round collar

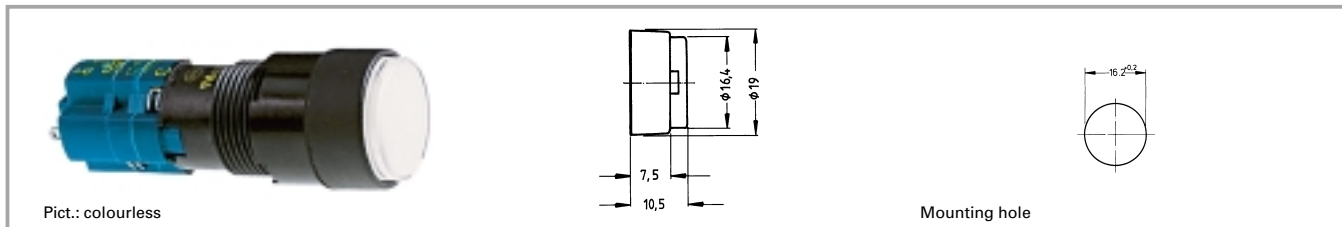

Contact arrangement	Contact function	Colour of collar	Order no. without lens	Note
1 NC + 1 NO	momentary	black	1.15.108.476/0000	Please include the desired lens in your order.
1 NC + 1 NO	latching	black	1.15.108.976/0000	Please include the desired lens in your order.
2 NC + 2 NO	momentary	black	1.15.108.477/0000	Please include the desired lens in your order.
2 NC + 2 NO	latching	black	1.15.108.977/0000	Please include the desired lens in your order.
3 NC + 3 NO	momentary	black	1.15.108.478/0000	Please include the desired lens in your order.
3 NC + 3 NO	latching	black	1.15.108.978/0000	Please include the desired lens in your order.

**LUMO**  
75 (65)

Technical data see page 1 - 54

Lens, round, transparent colourless, for filament lamp or LED: **5.49.259.013/1002**

Lens, round, transparent red, for LED: **5.49.259.013/1301**

Lens, round, transparent red, for filament lamp: **5.49.259.013/1303**

Lens, round, transparent yellow, for filament lamp or LED: **5.49.259.013/1402**

Lens, round, transparent green, for filament lamp: **5.49.259.013/1502**

Lens, round, transparent green, for LED: **5.49.259.013/1503**

Lens, round, transparent blue, for filament lamp: **5.49.259.013/1601**

#### Accessories:

Legend insert, round, without legend: 5.70.059.000/2000

**1****LUMOTAST 75 illuminated pushbutton IP65, flush lens, rectangular collar**

Pict.: green

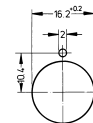
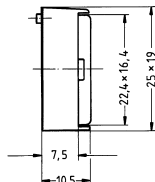

Contact arrangement	Contact function	Colour of collar	Order no. without lens	Note
1 NC + 1 NO	momentary	black	<b>1.15.108.076/0000</b>	Please include the desired lens in your order.
1 NC + 1 NO	latching	black	1.15.108.176/0000	Please include the desired lens in your order.
2 NC + 2 NO	momentary	black	1.15.108.077/0000	Please include the desired lens in your order.
2 NC + 2 NO	latching	black	1.15.108.177/0000	Please include the desired lens in your order.
3 NC + 3 NO	momentary	black	1.15.108.078/0000	Please include the desired lens in your order.
3 NC + 3 NO	latching	black	1.15.108.178/0000	Please include the desired lens in your order.

**LUMO  
75 (65)**

Technical data see page 1 - 54

Lens, rectangular, transparent colourless, for filament lamp or LED: **5.49.277.058/1002**Lens, rectangular, transparent red, for LED: **5.49.277.058/1301**Lens, rectangular, transparent red, for filament lamp: **5.49.277.058/1303**Lens, rectangular, transparent yellow, for filament lamp or LED: **5.49.277.058/1402**Lens, rectangular, transparent green, for filament lamp: **5.49.277.058/1502**Lens, rectangular, transparent green, for LED: **5.49.277.058/1503**Lens, rectangular, transparent blue, for filament lamp: **5.49.277.058/1601****Accessories:**

Legend insert, rectangular without legend: 5.70.630.000/2000

**1 LUMOTAST 75 signal lamp IP65**

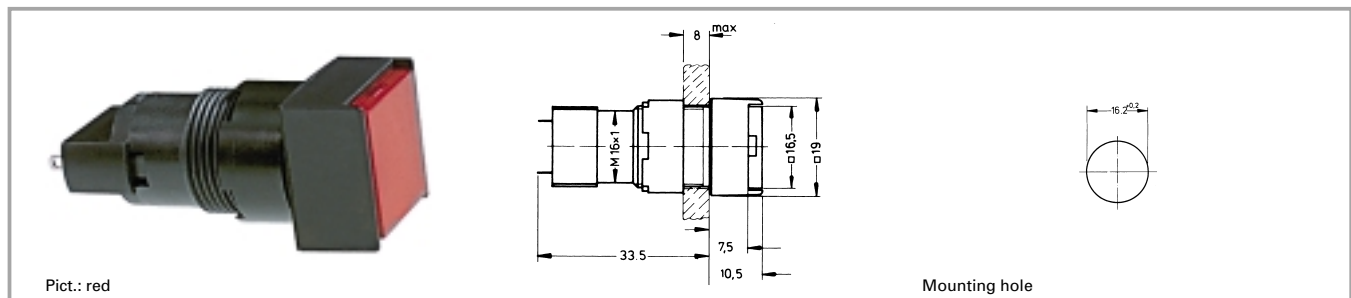

**Technical data**

**General information**

Form of lens see order block  
Form of collar see order block  
Diameter of collar see order block

**Electrical characteristics**

Voltage limit max. 42 V  
Power limit max. 1.2 W

**Other specifications**

Degree of protection from front side IP65  
Weight 5 g  
Approvals ENEC 25 T 55 (70), UL, CSA

**Dimensions**

Length of collar see order block  
Width of collar see order block  
Overall height 10.5 mm  
Mounting depth 33.5 mm  
Mounting hole 16.2 mm

Ambient temp. operating min. -25 °C  
Ambient temp. operating max. +55 °C  
Storage temperature min. -40 °C  
Storage temperature max. +80 °C

**Mechanical design**

Mounting ring nut  
Terminals solder terminals, tin-plated  
Lamp socket T 4.5  
Lamp filament lamp / LED

LUMO  
75 (65)

**Accessories LUMOTAST 75 signal lamp IP65**

Description	Photo	Order no.	Page
Filament lamp, T 4.5 base, 12 V		<b>1.90.100.022/0000</b>	5 - 6
Filament lamp, T 4.5 base, 24 V		<b>1.90.100.023/0000</b>	5 - 6
LED T 4.5 superbright, red, 24 V		<b>1.90.690.331/0000</b>	5 - 20
LED T 4.5 superbright, green, 24 V		<b>1.90.690.332/0000</b>	5 - 20
LED T 4.5 superbright, yellow, 24 V		<b>1.90.690.333/0000</b>	5 - 20
LED T 4.5 superbright, blue, 24 V		<b>1.90.690.334/0000</b>	5 - 20
LED T 4.5 superbright, white, 24 V		<b>1.90.690.335/0000</b>	5 - 20
LED T 4.5, red, 3 V		<b>1.90.692.001/0000</b>	5 - 19

## LUMOTAST 75 IP65

### Accessories LUMOTAST 75 signal lamp IP65

Description	Photo	Order no.	Page
LED T 4.5, yellow, 3 V		<b>1.90.692.003/0000</b>	5 - 19
Lamp extractor for T 4.5/5.5, lamp diameter 4 mm		<b>1.90.900.002/0000</b>	5 - 24
Lamp extractor for lamp diameter 5-6 mm		<b>1.90.900.004/0000</b>	5 - 24
Blanking cap, black, to cover spare holes, dimensions 18 x 18 mm		5.52.006.020/0103	5 - 33
Blanking cap, black, to cover spare holes, dimensions 18 x 24 mm		5.52.006.021/0100	5 - 33
Blanking cap, black, to cover spare holes, round 18 mm		5.52.006.022/0100	5 - 33
Fixing spanner M 15, M 16		<b>5.58.002.019/0105</b>	5 - 25

1

LUMO  
75 (65)

### LUMOTAST 75 signal lamp IP65, flush lens, square collar

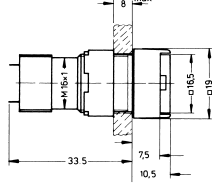
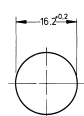
					
Pict.: red		Mounting hole			
Voltage limit max.	Power limit max.	Lamp socket	Form of collar	Order no. without lens	Note
42 V	1.2 W	T 4.5	square	<b>1.65.111.066/0000</b>	Please include the desired lens in your order.

Technical data see page 1 - 62

Lens, square, transparent colourless, for filament lamp or LED: **5.49.277.052/1002**

Lens, square, transparent red, for LED: **5.49.277.052/1301**

Lens, square, transparent red, for filament lamp: **5.49.277.052/1303**

Lens, square, transparent yellow, for filament lamp or LED: **5.49.277.052/1402**

Lens, square, transparent green, for filament lamp: **5.49.277.052/1502**

Lens, square, transparent green, for LED: **5.49.277.052/1503**

Lens, square, transparent blue, for filament lamp: **5.49.277.052/1601**

#### Accessories:

Legend insert, square: 5.70.629.000/2000

For assembly, press the lens as far as possible.



1

**LUMOTAST 75 signal lamp IP65, protruding lens, square collar**

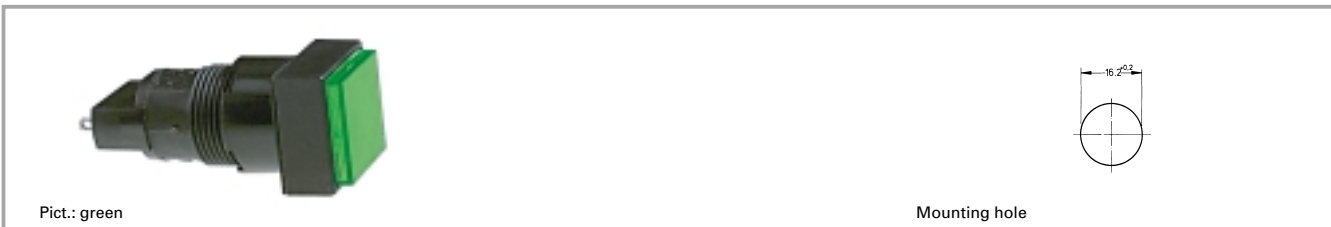

Voltage limit max.	Power limit max.	Lamp socket	Form of collar	Order no. without lens	Note
42 V	1.2 W	T 4.5	square	1.65.111.086/0000	Please include the desired lens in your order.

Technical data see page 1 - 62

- Lens, square, transparent colourless, for filament lamp or LED: **5.49.277.052/1002**
- Lens, square, transparent red, for LED: **5.49.277.052/1301**
- Lens, square, transparent red, for filament lamp: **5.49.277.052/1303**
- Lens, square, transparent yellow, for filament lamp or LED: **5.49.277.052/1402**
- Lens, square, transparent green, for filament lamp: **5.49.277.052/1502**
- Lens, square, transparent green, for LED: **5.49.277.052/1503**
- Lens, square, transparent blue, for filament lamp: **5.49.277.052/1601**

LUMO  
75 (65)

**Accessories:**  
Legend insert, round, without legend: 5.70.629.000/2000

For assembly, press the lens as far as possible.

**LUMOTAST 75 signal lamp IP65, flush lens, round collar**

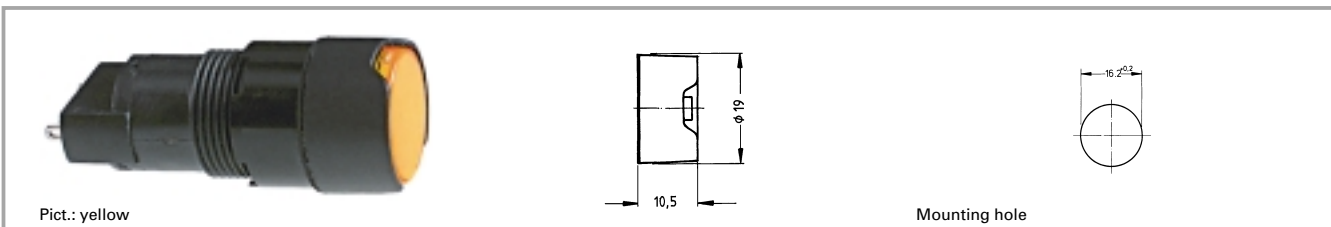

Voltage limit max.	Power limit max.	Lamp socket	Form of collar	Order no. without lens	Note
42 V	1.2 W	T 4.5	round	1.65.111.096/0000	Please include the desired lens in your order.

Technical data see page 1 - 62

- Lens, round, transparent colourless, for filament lamp or LED: **5.49.259.013/1002**
- Lens, round, transparent red, for LED: **5.49.259.013/1301**
- Lens, round, transparent red, for filament lamp: **5.49.259.013/1303**
- Lens, round, transparent yellow, for filament lamp or LED: **5.49.259.013/1402**
- Lens, round, transparent green, for filament lamp: **5.49.259.013/1502**
- Lens, round, transparent green, for LED: **5.49.259.013/1503**
- Lens, round, transparent blue, for filament lamp: **5.49.259.013/1601**

**Accessories:**  
Legend insert, round, without legend: 5.70.059.000/2000

For assembly, press the lens as far as possible.

## LUMOTAST 75 IP65

### LUMOTAST 75 signal lamp IP65, protruding lens, round collar

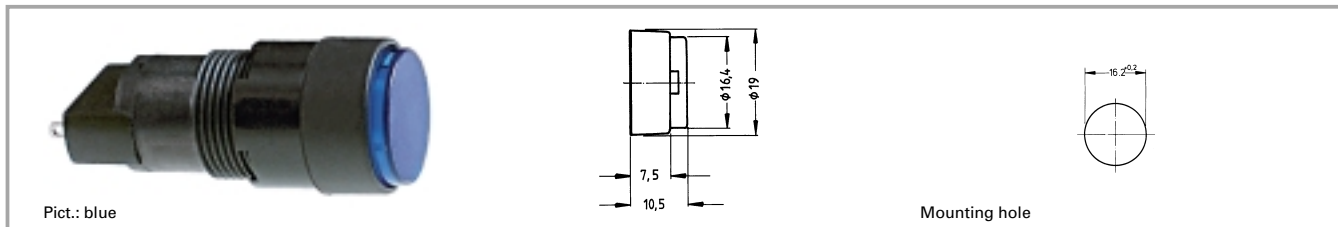

Voltage limit max.	Power limit max.	Lamp socket	Form of collar	Order no. without lens	Note
42 V	1.2 W	T 4.5	round	<b>1.65.111.076/0000</b>	Please include the desired lens in your order.

Technical data see page 1 - 62

Lens, round, transparent colourless, for filament lamp or LED: **5.49.259.013/1002**

Lens, round, transparent red, for LED: **5.49.259.013/1301**

Lens, round, transparent red, for filament lamp: **5.49.259.013/1303**

Lens, round, transparent yellow, for filament lamp or LED: **5.49.259.013/1402**

Lens, round, transparent green, for filament lamp: **5.49.259.013/1502**

Lens, round, transparent green, for LED: **5.49.259.013/1503**

Lens, round, transparent blue, for filament lamp: **5.49.259.013/1601**

#### Accessories:

Legend insert, round, without legend: 5.70.059.000/2000

For assembly, press the lens as far as possible.

**LUMO  
75 (65)**

### LUMOTAST 75 signal lamp IP65, flush lens, rectangular collar

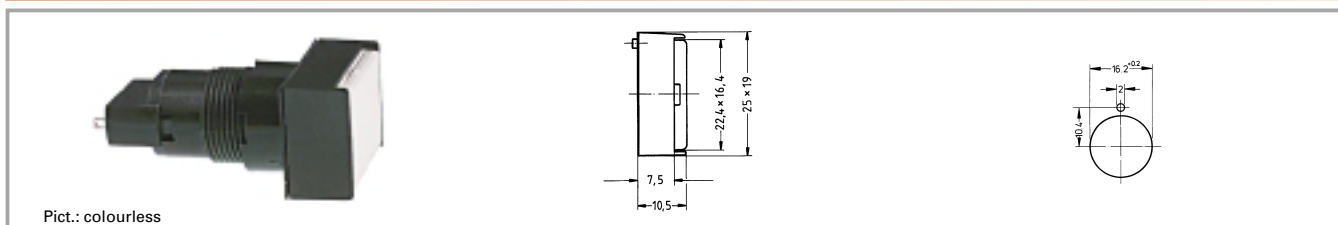

Voltage limit max.	Power limit max.	Lamp socket	Form of collar	Order no. without lens	Note
42 V	1.2 W	T 4.5	rectangular	<b>1.65.111.056/0000</b>	Please include the desired lens in your order.

Technical data see page 1 - 62

Lens, rectangular, transparent colourless, for filament lamp or LED: **5.49.277.058/1002**

Lens, rectangular, transparent red, for LED: **5.49.277.058/1301**

Lens, rectangular, transparent red, for filament lamp: **5.49.277.058/1303**

Lens, rectangular, transparent yellow, for filament lamp or LED: **5.49.277.058/1402**

Lens, rectangular, transparent green, for filament lamp: **5.49.277.058/1502**

Lens, rectangular, transparent green, for LED: **5.49.277.058/1503**

Lens, rectangular, transparent blue, for filament lamp: **5.49.277.058/1601**

#### Accessories:

Legend insert, rectangular without legend: 5.70.630.000/2000

For assembly, press the lens as far as possible.

## X-ON Electronics

Largest Supplier of Electrical and Electronic Components

*Click to view similar products for [Pushbutton Switches](#) category:*

*Click to view products by [Rafi](#) manufacturer:*

Other Similar products are found below :

[LW1L-M1C10V-A](#) [LW2L-A1C20M-GD](#) [LW2L-M1C20M-A](#) [60324L](#) [M7E-HRN2](#) [67021K512](#) [67081K512X](#) [701PB580](#) [719-5504-000](#)  
[MDPSSGLFS](#) [810KSV30B](#) [FLT 2U EE 01A](#) [MML21KA3ABK](#) [MML23KA3AC05K-001](#) [MML23KW3AA01W](#) [8418K2](#) [8646AB6X718UL](#)  
[8646ABUL](#) [FSDWH](#) [9001KXRK](#) [9001T8BK](#) [9533CD4+U574+U4922](#) [1203MRA](#) [A22EM01S](#) [A595](#) [1202A6](#) [12037A2ULCSA](#) [1203A2UL](#)  
[ABD122N-B](#) [1211390004](#) [ABN111-Y](#) [ABN400-R](#) [1211500044](#) [1211580012](#) [1212MRA](#) [1232A6NF](#) [RA3CSH6A](#) [1241.1183.7047](#)  
[1241.2511](#) [1241.3428](#) [1223A2ULCSA](#) [1223MRA](#) [1232AX2119](#) [1241.1183.8000](#) [1241.1183.8029](#) [1241.2506](#) [1241.2606](#) [12MA6](#)  
[1301940184](#) [RELBARF6X10\(PLASTIC\)](#)