

RAFIX 22 QR - Contact block with silver contacts, with coupling, without lamp socket, screw terminals, 2 NO
1.20.124.020/0000

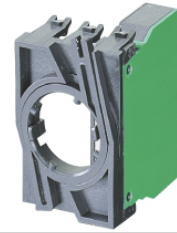

Dimensions

Dimensions with coupling	39.5 x 49.9 x 30 mm
Mounting depth without cable	56.4 mm

Mechanical design

Mounting	snap on coupling and actuator
Contact system	bridge-contact self cleaning
Contact materials	Ag
Contact arrangement	2 NO
Coupling position 1 (1/2)	2 NO
Coupling position 3 (5/6), centre	-
Coupling position 2 (3/4)	-
NC contact forcibly actuated acc. to IEC 60947-5-1	yes
Terminals	screw terminals
Terminal marking	color encoded
Robustness	100 N
Wire range solid wires without wire end sleeves	2 x 0.75 ... 2.5 mm ²
Wire range stranded wires without end sleeves	2 x 1.0...1.5 (2 x 0.08 ... 2.5) mm ²
Stripping length, solid or stranded	8 mm
Wire range with wire end sleeves	2 x 0.75 ... 1.5 mm ²

Electric characteristics acc. to IEC 60947

Rated insulation voltage AC/DC	400 V
Rated peak voltage	6,000 V
Rated operating current I _e AC 12 / DC 12	10 A
Rated operating current I _e AC-15	125 V/10 A, 250 V/6 A, 400 V/3.5 A
Rated operating current I _e DC-13 Q300	24V/2.75A, 60V/1.1A, 125V/0.55A, 250V/0.275A
Degree of pollution	3
Positive opening travel	3 mm
Operating speed	5 ... 1000 mm/c

Electric characteristics acc. to IEC 61058

Resistive load AC	10 A / 250 V; 7.5 A / 400 V
Motor load AC	6 A / 250 V; 4 A / 400 V (5 A / 250 V)
Peak input current filament lamp AC	36 A
Peak capacity input current AC	100 A

Protection class	II
------------------	----

Lamp characteristics

Lamp characteristics	BA 9 s
----------------------	--------

Other specifications

Operating life at 10 A/250 V AC	70,000 (10A), 200,000 (5A)
Switching reliability at 24V/5mA DC	10×10^{-6}
Robustness	acc. to IEC 60947-5-5
Corresponding to CE	acc. EU-guideline NSR 72/73
Shock resistance acc. to IEC 60068-2-27	15 g at 11 ms, amplitude half sinusoidal
Resistance to vibrations acc. to IEC 60068-2-6	5 g at 10 ... 500 Hz
Ambient temp. operating min.	-25 °C
Ambient temp. operating max.	+70°C (+50°C)
Storage temperature min.	-40 °C
Storage temperature max.	+80 °C
Hot wire ignition acc. to IEC 60695-2-1	yes
Environmental resistance	acc. to IEC 60068-2-14, -30, -33 and -78
ROHS compliant	yes
REACH compliant	yes

with contact block

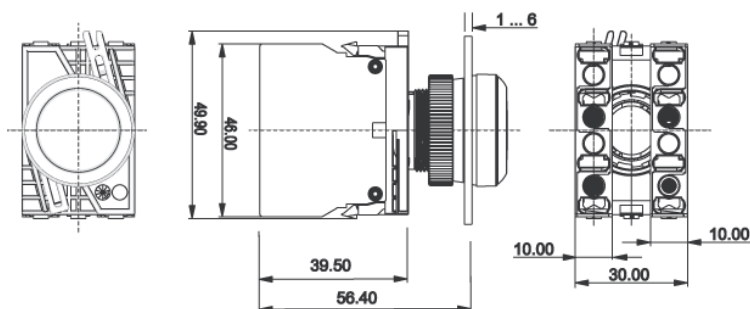

X-ON Electronics

Largest Supplier of Electrical and Electronic Components

Click to view similar products for [Switch Contact Blocks / Switch Kits](#) category:

Click to view products by [RAFI](#) manufacturer:

Other Similar products are found below :

[61-8770.17](#) [M2SA-7010](#) [704.905.2](#) [704.915.5](#) [84-8512.2320](#) [A01RTC8](#) [A02504](#) [A02512](#) [A3KJ-7010](#) [BS001](#) [190-17504-003](#) [190-17505-001](#) [190-17508-001](#) [190-17509-002](#) [190-17509-006](#) [A02506](#) [190-17501-001](#) [190-17506-001](#) [190-17509-003](#) [190-17509-005](#) [GLZ304](#) [51401](#) [BS010](#) [BST-D](#) [HW-S01](#) [XESP2021](#) [61-8480.22](#) [61-8650.17](#) [704.908.1](#) [704.908.5](#) [704.915.3](#) [HA-C2V](#) [S4](#) [704.918.4](#) [5.00.100.105/0000](#) [84-8511.5320](#) [A3CA-7121](#) [84-8511.6320](#) [704.902.1](#) [A0310Y](#) [51-971.F22](#) [5.05.510.632/0000](#) [190-17502-003](#) [190-17507-002](#) [190-17500-006](#) [190-17510-001](#) [1.20.119.002/0000](#) [2MN6-1PA224](#) [Kit05-Keylocks](#) [Kit14-Switch Assortment](#)