

Fakra R3C – Right-Angle housing
Cable type **RG174** (2.6/50) & **RTK** (3.2/50)

R197.125._80

TECHNICAL DATA SHEET

Rev	Date	Edited	Approved	Validated	Modification
1	21/06/2018	C.Chavanne	Y.Gay	R.Chantre	Creation

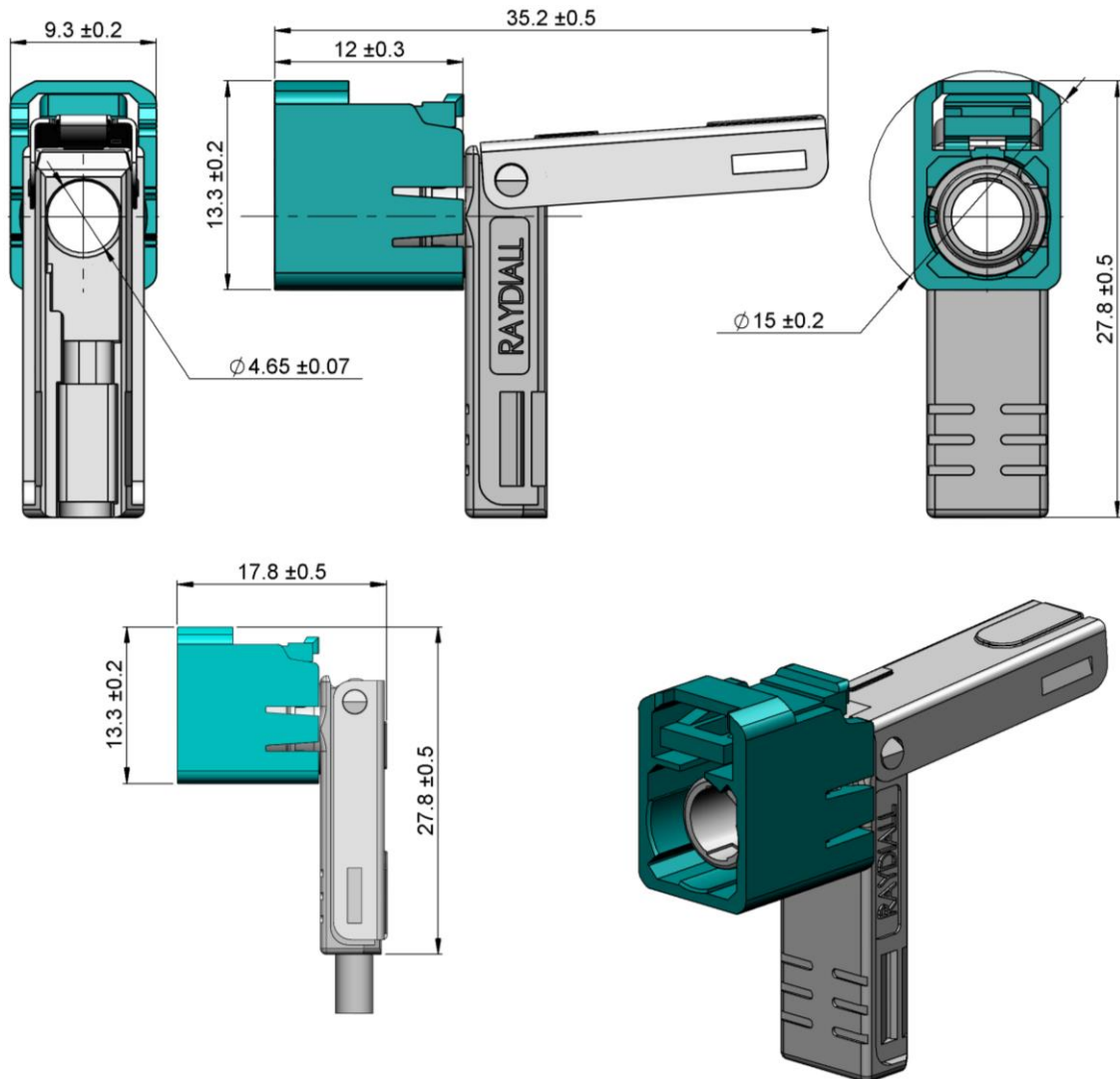

All dimensions are in mm

COMPONENTS	MATERIALS	UL CLASSIFICATION	COLOR
Housing	Polyamide	UL 94 V-2	See page 2
Cap	Inox		
Sleeve	Die Cast	Chromatation	Tint variation may happen depending on moulding shots

Fakra R3C – Right-Angle housing
Cable type **RG174** (2.6/50) & **RTK** (3.2/50)

R197.125._80

TECHNICAL DATA SHEET

Interface

According to

ISO 20860-1

Application

This housing is part of an assembly to create a complete R-A R3C connector. It has to be assembled with a terminal.
Refer to **Assembly Instructions AI_R-AR3C** to get the corresponding P/N.

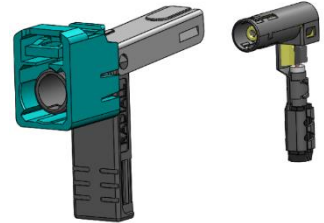

Codings

To obtain the complete part number, please fill in the blank “_” with the coding letter.

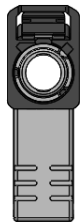

A
Black
RAL 9005

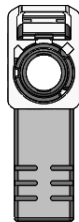

B
Crème White
RAL 9001

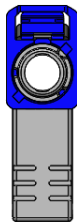

C
Blue
RAL 5005

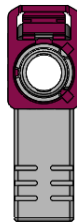

D
Bordeaux
RAL 4004

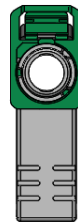

E
Green
RAL 6002

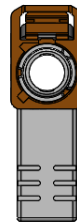

F
Brown
RAL 8011

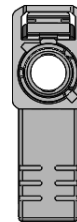

G
Grey
RAL 7031

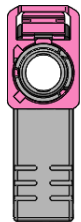

H
Violet
RAL 4003

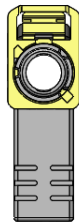

I
Beige
RAL 1001

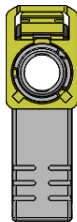

K
Curry
RAL 1027

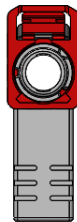

L
Carmin
RAL 3002

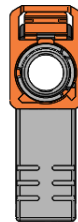

M
Pastel Orange
RAL 2003

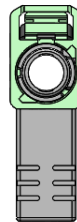

N
Pastel Green
RAL 6019

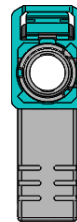

Z
Water blue
RAL 5021

Net Weight: 4.63 g

Storage condition & Shelf Life

Boxes should be stored indoors, in its original packaging (box + plastic bag), in a controlled climate environment not exceeding -20°C/+40°C and maximum 70% relative humidity. The boxes should be protected from direct sunlight and should be used on a "first-in, first-out" basis.

It is recommended to use this reference within 1 year from the date of manufacture when stored according the recommended storage condition.

Product Handling

Care must be taken when handling the boxes of housings. They must not fall. Indeed it might unwillingly lock the cap, which makes the housing un-usable.

Fakra R3C – Right-Angle housing
Cable type **RG174** (2.6/50) & **RTK** (3.2/50)

R197.125._80

TECHNICAL DATA SHEET

Packaging: 1 welded plastic bag inside cardboard box

Number of housings/ Plastic bag: 1000 pcs / box: 1000 Pcs



Cardboard box

Dimensions (WxLxH): 29 x 20 x 20 cm

Weight: ≈ 5kg



Plastic bag

X-ON Electronics

Largest Supplier of Electrical and Electronic Components

Click to view similar products for [RF Connector Accessories](#) category:

Click to view products by [Raydiall](#) manufacturer:

Other Similar products are found below :

[89674-0712](#) [F702RX24](#) [FERRULE-174](#) [R125802000](#) [R141802000](#) [R141805000](#) [R141842000](#) [R161844000](#) [R161862000](#) [R161862000W](#)
[R280752000](#) [R280907000](#) [R694261906](#) [RFI21-13](#) [RFI375-12-D3](#) [RFI75-13-D2](#) [RFI75-3](#) [RFI75-4-D2](#) [RFI97-13](#) [AX102906](#) [AX102907](#)
[18097-0013](#) [HP-375](#) [HP-500](#) [2098-0294-00](#) [2098-3251-94](#) [KA-81-05](#) [89674-0805](#) [F1](#) [FERRULE-223](#) [202102-11](#) [213337-1](#) [220222-2](#)
[24092671A](#) [24092678A](#) [R161841000](#) [R280468000](#) [R280510000](#) [R282862060](#) [RFI155-1](#) [RFI25-12-D3](#) [RFI25-5](#) [RFI25-5-D3](#) [RFI75-12-D2](#)
[RFI75-2-D2](#) [RFI75-4-D3](#) [RFI77-6](#) [RFI97-14](#) [360HS001M2508M6](#) [4-1532137-4](#)