

OLED DISPLAY SPECIFICATION



RAYSTAR

RAYSTAR Optronics, Inc.
曜凌光電股份有限公司



曜凌光電股份有限公司

Raystar Optronics, Inc.

T: +886-4-2565-0761 | F: +886-4-2565-0760

sales@raystar-optronics.com | www.raystar-optronics.com

SPECIFICATION

Model No:

REX012864AJWPP3N00000

CUSTOMER:

| | |
|-------------|--|
| APPROVED BY | |
| PCB VERSION | |
| DATE | |

FOR CUSTOMER USE ONLY

| SALES BY | APPROVED BY | CHECKED BY | PREPARED BY |
|----------|-------------|------------|-------------|
| | | | |

Release DATE:

APPROVAL FOR SPECIFICATIONS ONLY

APPROVAL FOR SPECIFICATIONS AND SAMPLE



Revision History

| VERSION | DATE | REVISED PAGE NO. | Note |
|---------|------------|------------------|---------------|
| 0 | 2022/02/17 | | First release |



Contents

- 1.General Specification
- 2.Module Classification Information
- 3.Interface Pin Function
- 4.Contour Drawing & Block Diagram
- 5.Absolute Maximum Ratings
- 6.Electrical Characteristics
- 7.Optical Characteristics
- 8.OLED Lifetime
- 9.Reliability
- 10.Inspection specification
- 11.Precautions in use of OLED Modules

1. General Specification

The Features is described as follow:

- Module dimension: 60.5 × 37.0 × 2.11 mm
- Active area: 55.01 × 27.49mm
- Dot Matrix: 128 × 64
- Dot size: 0.40 × 0.40 mm
- Dot pitch: 0.43 × 0.43 mm
- Display Mode : Passive Matrix
- Duty: 1/64 Duty
- Display Color: OLED , White
- Interface: I2C , 4-line SPI , 8-bits 6800 or 8080 parallel
- IC: CH1116
- SIZE: 2.42 inch

RAYSTAR OPTRONICS

2.Module Classification information

| | | | | | | | | | | | | | |
|---|---|---|--------|----|---|---|---|---|----|----|----|----|----|
| 1 | 2 | 3 | 4 | 5 | 6 | 7 | 8 | 9 | 10 | 11 | 12 | 13 | 14 |
| R | E | X | 012864 | AJ | W | P | P | 3 | N | 0 | 0 | 0 | 00 |

| | | | | | |
|----|--------------------------------|----------------------------------------------------------------------|--|--------------------|----------------|
| 1 | Brand : Raystar Optronics Inc. | | | | |
| 2 | E : OLED | | | | |
| 3 | Display Type | C : COB Character | | G : COB Graphic | |
| | | X : COG | | H : COG + FR | |
| | | P : COG + FR + PCB | | T : COF | |
| | | A : COG + PCB | | N : COF + FR + PCB | |
| 4 | Dot Matrix : 128*64 | | | | |
| 5 | Series | | | | |
| 6 | Emitting Color | A : Amber | | R : Red | C : Full Color |
| | | B : Blue | | W : White | |
| | | G : Green | | Y : Yellow | |
| | | S : Sky Blue | | X : Dual Color | |
| 7 | Polarizer | P : With Polarizer; N: Without Polarizer A : Anti-glare Polarizer | | | |
| 8 | Display Mode | P : Passive Matrix ; N : Active Matrix | | | |
| 9 | Driver Voltage | 3 : 3.0~3.3V ; 5 : 5.0V | | | |
| 10 | Touch Panel | N : Without touch panel; T: With touch panel | | | |
| 11 | Product type | 0 : Standard | | | |
| 12 | Inspection Grade | 0 : Standard | | | |
| 13 | Option | 0 : Default | | | |
| 14 | Serial No. | Serial number(00~99) | | | |

3.Interface Pin Function

| No. | Symbol | Function | | | | | | | | | | | | | | | |
|------|-----------------------------------------|---------------------------------------------------------------------------------------------------------------------------------------------------------------------------------------------------------------------------------------------------------------------------------------------------------------------------------------------------------------------------------------------------------------------------|------|------|------|------------|------------|-----|---|---|---|---|-----|---|---|---|---|
| 1 | NC(GND) | No connection | | | | | | | | | | | | | | | |
| 2 | VSS | Ground. | | | | | | | | | | | | | | | |
| 3-10 | NC | No connection | | | | | | | | | | | | | | | |
| 11 | VDD1 | Power supply input | | | | | | | | | | | | | | | |
| 12 | IM1 | These are the MPU interface mode select pads. | | | | | | | | | | | | | | | |
| | | <table border="1"> <thead> <tr> <th></th> <th>8080</th> <th>I2C</th> <th>6800</th> <th>4-wire SPI</th> </tr> </thead> <tbody> <tr> <td>IM1</td> <td>1</td> <td>1</td> <td>0</td> <td>0</td> </tr> <tr> <td>IM2</td> <td>1</td> <td>0</td> <td>1</td> <td>0</td> </tr> </tbody> </table> | | 8080 | I2C | 6800 | 4-wire SPI | IM1 | 1 | 1 | 0 | 0 | IM2 | 1 | 0 | 1 | 0 |
| | | | 8080 | I2C | 6800 | 4-wire SPI | | | | | | | | | | | |
| IM1 | 1 | 1 | 0 | 0 | | | | | | | | | | | | | |
| IM2 | 1 | 0 | 1 | 0 | | | | | | | | | | | | | |
| IM2 | 1 | 0 | 1 | 0 | | | | | | | | | | | | | |
| 13 | IM2 | Note (1) 0 is connected to VSS (2) 1 is connected to VDD1 | | | | | | | | | | | | | | | |
| 14 | NC | No connection | | | | | | | | | | | | | | | |
| 15 | \overline{CS} | This pad is the chip select input. When $\overline{CS} = "L"$, then the chip select becomes active, and data/command I/O is enabled. | | | | | | | | | | | | | | | |
| 16 | \overline{RES} | This is a reset signal input pad. When \overline{RES} is set to "L", the settings are initialized. The reset operation is performed by the \overline{RES} signal level. | | | | | | | | | | | | | | | |
| 17 | A0 | This is the Data/Command control pad that determines whether the data bits are data or a command. A0 = "H": the inputs at D0 to D7 are treated as display data. A0 = "L": the inputs at D0 to D7 are transferred to the command registers. In I2C interface, this pad serves as SA0 to distinguish the different address of OLED driver. | | | | | | | | | | | | | | | |
| 18 | \overline{WR} (R/ \overline{W}) | This is a MPU interface input pad. When connected to an 8080 MPU, this is active LOW. This pad connects to the 8080 MPU \overline{WR} signal. The signals on the data bus are latched at the rising edge of the \overline{WR} signal. When connected to a 6800 Series MPU: This is the read/write control signal input terminal. When R/ \overline{W} = "H": Read. When R/ \overline{W} = "L": Write. | | | | | | | | | | | | | | | |

| | | |
|-------|---------------------------|-----------------------------------------------------------------------------------------------------------------------------------------------------------------------------------------------------------------------------------------------------------------------------------------------------------------------------------------------------------------------------------------------------------------------------------------------------------------------------------------------------------------------------------------------------------|
| 19 | E/ $\overline{\text{RD}}$ | <p>This is a MPU interface input pad. When connected to an 8080 series MPU, it is active LOW. This pad is connected to the $\overline{\text{RD}}$ signal of the 8080 series MPU, and the data bus is in an output status when this signal is "L". When connected to a 6800 series MPU, this is active HIGH. This is used as an enable clock input of the 6800 series MPU. When $\overline{\text{RD}}$ = "H": Enable. When $\overline{\text{RD}}$ = "L": Disable.</p> |
| 20~27 | D0~D7 | <p>This is an 8-bit bi-directional data bus that connects to an 8-bit or 16-bit standard MPU data bus. When the serial interface is selected, then D0 serves as the serial clock input pad (SCL) and D1 serves as the serial data input pad (SI). At this time, D2 to D7 are set to high impedance. When the I2C interface is selected, then D0 serves as the serial clock input pad (SCL) and D1 serves as the serial data input pad (SDAI). At this time, D2 to D7 are set to high impedance.</p> |
| 28 | IREF | <p>This is a segment current reference pad. A resistor should be connected between this pad and VSS. Set the current at 18.75uA.</p> |
| 29 | VCOMH | <p>This is a pad for the voltage output high level for common signals. A capacitor should be connected between this pad and VSS.</p> |
| 30 | VPP | <p>OLED panel power supply. Generated by internal charge pump. Connect to capacitor. It could be supplied externally.</p> |
| 31 | NC(GND) | <p>No connection</p> |



RAYSTAR

4. Contour Drawing & Block Diagram

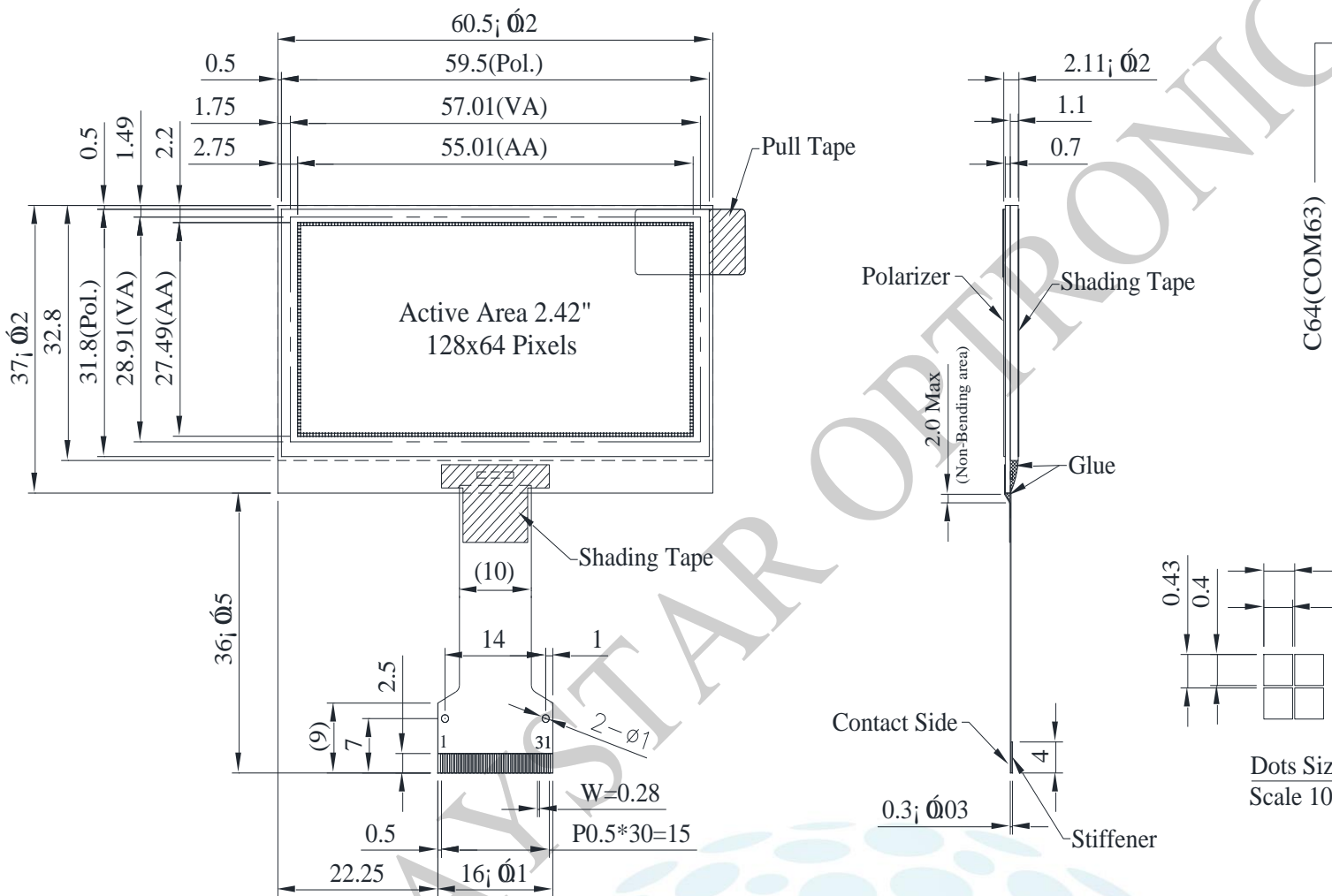

The non-specified tolera



4.1 Application recommendations

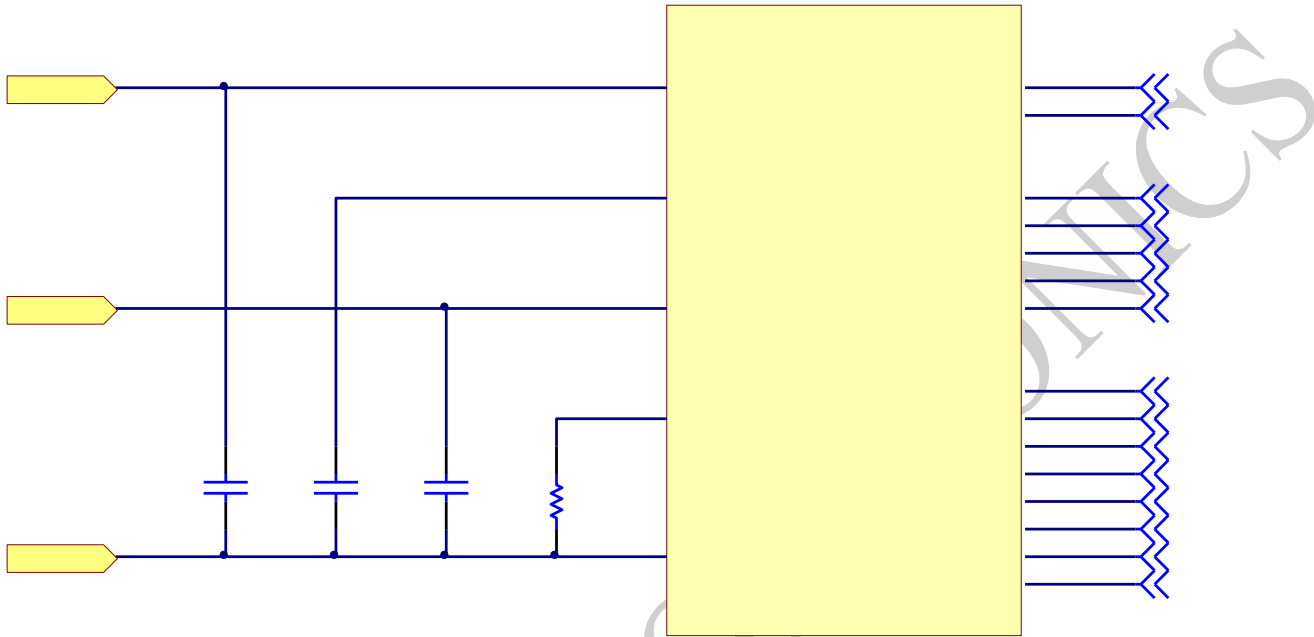

Recommended components :

C1, C2, C3 : 4.7uF

Bus Interface selection: (Must be set the IM[2:1], refer to item 3)
8-bits 6800 or 8080 parallel, 4-wire SPI, I2C

Voltage at IREF = $V_{PP} - 3.5V$. For $V_{PP} = 13V$, $I_{REF} = 18.75\mu A$:

$$(R1 + 150K) = (\text{Voltage at IREF} - V_{SS}) / I_{REF}$$

$$R1 = [(13 - 3.5) V / 18.75\mu A] - 150K \text{ ohm}$$

$$\geq 357K \text{ ohm}^{(2)}$$

R1 recommends 562K ohm. If new module want to be compatible with hardware using past module (IC SSD1309 with higher R1), then the initial code must be modified to meet typical brightness (adjust contrast or VCOM to higher level).

Note:

(1).The capacitor value is recommended value. Select appropriate value against module application.

(2).Minimum value. When OLED product application, then R1 must be greater than the calculated value.

5. Absolute Maximum Ratings

| Parameter | Symbol | Min | Max | Unit | Notes |
|----------------------------|--------|------|------|------|-------|
| Supply Voltage for Logic | VDD1 | -0.3 | 3.6 | V | 1, 2 |
| Supply Voltage for Display | VPP | 0 | 14.5 | V | 1, 2 |
| Operating Temperature | TOP | -40 | +80 | °C | - |
| Storage Temperature | TSTG | -40 | +85 | °C | - |

Note :

1. All the above voltages are on the basis of "VSS = 0V".
2. When this module is used beyond the above absolute maximum ratings, permanent breakage of the module may occur. Also, for normal operations, it is desirable to use this module under the conditions according to Section 6 "Electrical Characteristics". If this module is used beyond these conditions, malfunctioning of the module can occur and the reliability of the module may deteriorate.
3. The absolute limit temperature was verified according to the test conditions of reliability test (See section 9. Reliability) , and module was met all criteria.
4. The defined temperature ranges do not include the polarizer. The maximum withstood temperature of the polarizer should be 80 °C.

6. Electrical Characteristics

6.1 DC Electrical Characteristics

| Item | Symbol | Condition | Min | Typ | Max | Unit |
|----------------------------|--------|-----------|----------|------|----------|------|
| Supply Voltage for Logic | VDD1 | — | 1.65 | 3.0 | 3.3 | V |
| Supply Voltage for Display | VPP | — | 6.4 | 13.0 | 13.5 | V |
| High Level Input | VIH | — | 0.8×VDD1 | — | VDD1 | V |
| Low Level Input | VIL | — | VSS | — | 0.2×VDD1 | V |
| High Level Output | VOH | — | 0.8×VDD1 | — | VDD1 | V |
| Low Level Output | VOL | — | VSS | — | 0.2×VDD1 | V |
| Display 50% Pixel on | IPP | VPP =13V | — | 15 | 30 | mA |

Note: The VCC (VPP) value can be adjusted according to the demand brightness. When VCC (VPP) is lowered, the brightness decreases or when VCC (VPP) is increased, the brightness increases. The VCC (VPP) value is set within the recommended range. The life time of OLED is directly related to the set brightness, and lower brightness helps to improve the life time.



6.2 Initial code

```
void Initial_CH1116(){  
    WriteCommand(0xAE);        //display off  
    WriteCommand(0xB0);        //set page address  
    WriteCommand(0x10);        //set higher column address  
    WriteCommand(0x04);        //set lower column address  
    WriteCommand(0xD5);        //set display clock divide ratio/oscillator frequency  
    WriteCommand(0xF0);  
  
    WriteCommand(0xA8);        //Multiplex Ration  
    WriteCommand(0x3F);  
  
    WriteCommand(0xD3);        //set display offset  
    WriteCommand(0x00);  
  
    WriteCommand(0x40);        //set start line  
  
    WriteCommand(0xAD);        //DC-DC Control Mode Set  
    WriteCommand(0x8A);        //DC-DC OFF  
  
    WriteCommand(0xA1);        //set segment re-map  
  
    WriteCommand(0xC8);        //set common output scan direction  
  
    WriteCommand(0xDA);        //common pad configuration  
    WriteCommand(0x12);  
  
    WriteCommand(0x81);        //set contrast  
    WriteCommand(0x1F);  
  
    WriteCommand(0xD9);        //set dis-charge/pre-charge period  
    WriteCommand(0x1f);  
  
    WriteCommand(0xDB);        //set VCOM deselect level  
    WriteCommand(0x35);  
  
    WriteCommand(0xA4);        //set entire display off  
  
    WriteCommand(0xA6);        //set normal display  
  
    WriteCommand(0xAF);        //display on  
}
```

Note 1: Initial code is for reference only. Please make the best adjustment with the OLED module.
Note 2: Command: Set Contrast Control (0x81) , This command sets the Contrast Setting of the display. The chip has 256 contrast steps from 00h to FFh. The segment output current increases as the contrast step value increases. The segment current increases, the OLED brightness increases.

I2C-bus data format

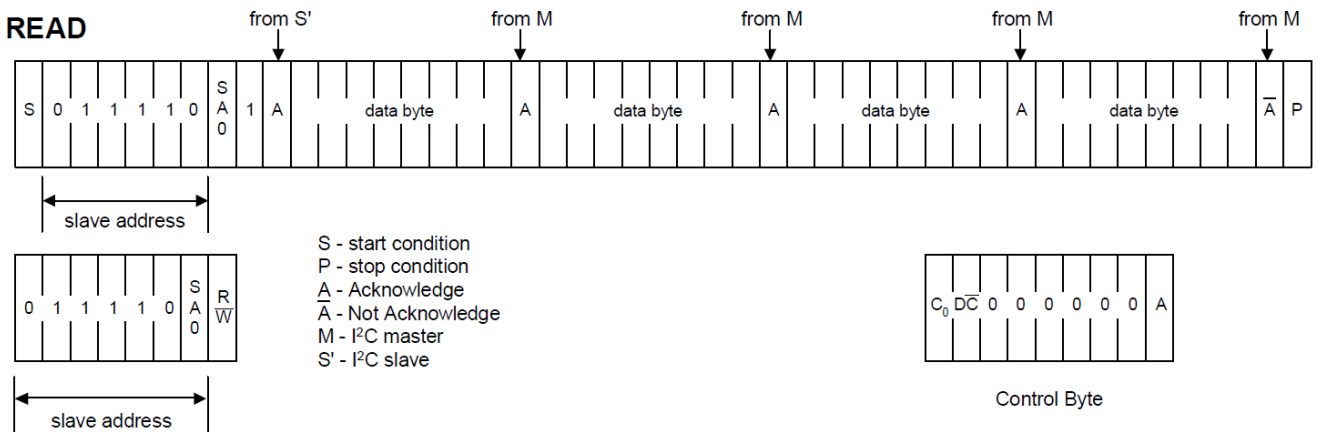
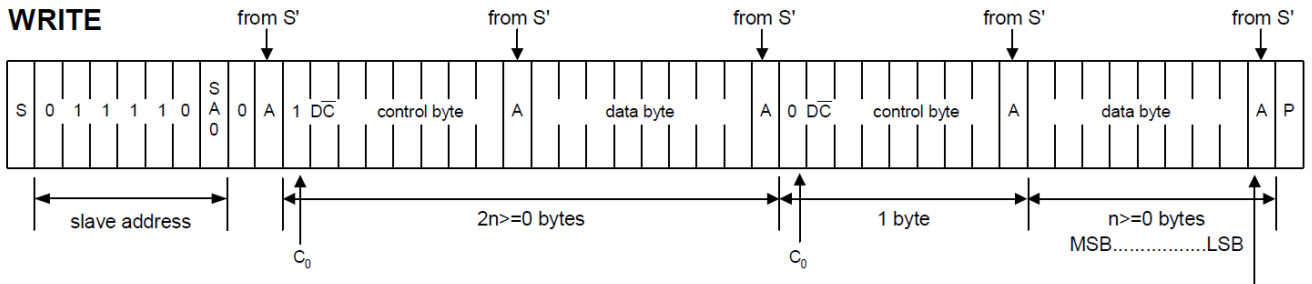

Note1:

1. Co = "0" : The last control byte , only data bytes to follow,
Co = "1" : Next two bytes are a data byte and another control byte;
2. D/C = "0" : The data byte is for command operation,
D/C = "1" : The data byte is for RAM operation.
3. SA0 = Slave address bit

I2C address bit (SA0)

The slave address is following the start condition for recognition use. The slave address is either "b0111100" or "b0111101" by changing the SA0 to LOW or HIGH (A0 pin acts as SA0).

7.Optical Characteristics

| Item | Symbol | Condition | Min | Typ | Max | Unit |
|---------------------------------------------------------|--------------|-----------|----------|------|------|-------------------|
| View Angle | (V) θ | — | 160 | — | — | deg |
| | (H) ϕ | — | 160 | — | — | deg |
| Contrast Ratio | CR | Dark | 10,000:1 | — | — | — |
| Response Time | T rise | — | — | 10 | — | μ s |
| | T fall | — | — | 10 | — | μ s |
| Display with 50% checkerboard Brightness ⁽¹⁾ | | | 70 | 90 | — | cd/m ² |
| CIEx(White) | | (CIE1931) | 0.26 | 0.28 | 0.30 | — |
| CIEy(White) | | (CIE1931) | 0.30 | 0.32 | 0.34 | — |

Note :

1. The brightness value is based on the setting of VCC(VPP) equal to the Typical value.
2. 50% checkerboard means half of the display area turn on & half area turn off, shown as a checkerboard.

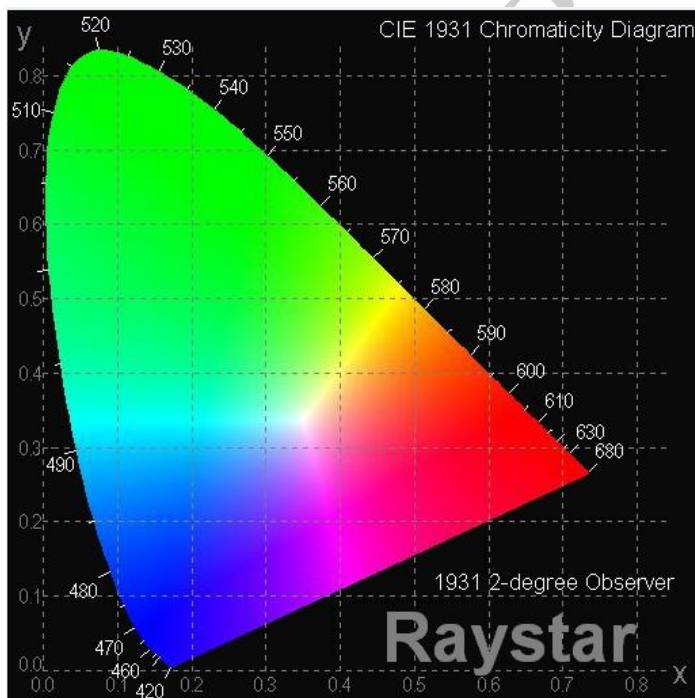



8.OLED Lifetime

| ITEM | Conditions | Min | Typ | Remark |
|---------------------|-------------------------------------------------------------------|------------|-----|--------|
| Operating Life Time | Ta=25°C / Initial 50% checkerboard brightness Typical Value | 20,000 Hrs | - | Note |

Notes:

1. Life time is defined the amount of time when the luminance has decayed to <50% of the initial value.
2. This analysis method uses life data obtained under accelerated conditions to extrapolate an estimated probability density function (*pdf*) for the product under normal use conditions.
3. Screen saving mode will extend OLED lifetime.
4. 50% checkerboard means half of the display area turn on & half area turn off, shown as a checkerboard.

9. Reliability

Content of Reliability Test

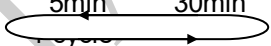
| Environmental Test | | | |
|--------------------------------------|-----------------------------------------------------------------------------------------------------------------------------------------------------------------------------------------------------------|-----------------------------------------------------------------------------------|---------------------|
| Test Item | Content of Test | Test Condition | Applicable Standard |
| High Temperature storage | Endurance test applying the high storage temperature for a long time. | 85°C 240hrs | — |
| Low Temperature storage | Endurance test applying the low storage temperature for a long time. | -40°C 240hrs | — |
| High Temperature Operation | Endurance test applying the electric stress (Voltage & Current) and the thermal stress to the element for a long time. | 80°C 240hrs | — |
| Low Temperature Operation | Endurance test applying the electric stress under low temperature for a long time. | -40°C 240hrs | — |
| High Temperature/ Humidity Storage | Endurance test applying the high temperature and high humidity storage for a long time. | 60°C, 90%RH 240hrs | — |
| High Temperature/ Humidity Operation | Endurance test applying the high temperature and high humidity Operation for a long time. | 60°C, 90%RH 120hrs | — |
| Temperature Cycle | Endurance test applying the low and high temperature cycle. -40°C 25°C 80°C 30min 5min 30min  | -40°C / 80°C 30 cycles | — |
| Mechanical Test | | | |
| Vibration test | Endurance test applying the vibration during transportation and using. | Frequency: 10~55Hz amplitude: 1.5mm Time: 0.5hrs/axis Test axis: X, Y, Z | — |
| Others | | | |
| Static electricity test | Endurance test applying the electric stress to the finished product housing. | Air Discharge model ±4kv, 10 times | — |

*** Supply voltage for OLED system = Operating voltage at 25°C



Test and measurement conditions

1. All measurements shall not be started until the specimens attain to temperature stability. After the completion of the described reliability test, the samples were left at room temperature for 2 hrs prior to conducting the failure test at $23\pm 5^{\circ}\text{C}$; $55\pm 15\%$ RH.
2. All-pixels on/off exchange is used as operation test pattern.
3. The degradation of Polarizer are ignored for High Temperature storage, High Temperature/ Humidity Storage, Temperature Cycle

Evaluation criteria

1. The function test is OK.
2. No observable defects.
3. Luminance: $> 50\%$ of initial value.
4. Current consumption: within $\pm 50\%$ of initial value.

APPENDIX:

RESIDUE IMAGE

Because the pixels are lighted in different time, the luminance of active pixels may reduce or differ from inactive pixels. Therefore, the residue image will occur. To avoid the residue image, every pixel needs to be lighted up uniformly.

RAYSTAR OPTROPNICS

10. Inspection specification

Inspection Standard:

MIL-STD-105E table normal inspection single sample level II.

Definition

1 Major defect : The defect that greatly affect the usability of product.

2 Minor defect : The other defects, such as cosmetic defects, etc.

Definition of inspection zone:

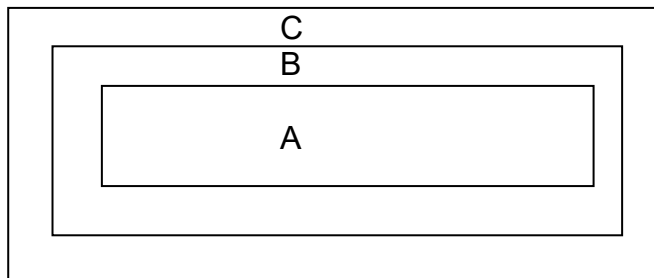

Zone A: Active Area

Zone B: Viewing Area except Zone A

Zone C: Outside Viewing Area

Note: As a general rule, visual defects in Zone C are permissible, when it is no trouble of quality and assembly to customer`s product.

Inspection Methods

1 The general inspection : Under fluorescent light illumination: 750~1500 Lux, about 30cm viewing distance, within 45° viewing angle, under 25±5°C.

2 The luminance and color coordinate inspection : By SR-3 or BM-7 or the equal equipments, in the dark room, under 25±5°C.

| NO | Item | Criterion | AQL |
|----|---------------------------------------------|---------------------------------------------------------------------------------------------------------------------------------------------------------------------------------------------------------------------------------------------------------------------------------------------------------------------------|------|
| 01 | Electrical Testing | 1.1 Missing vertical, horizontal segment, segment contrast defect. 1.2 Missing character , dot or icon. 1.3 Display malfunction. 1.4 No function or no display. 1.5 Current consumption exceeds product specifications. 1.6 OLED viewing angle defect. 1.7 Mixed product types. 1.8 Contrast defect. | 0.65 |
| 02 | Black or white spots on OLED (display only) | 2.1 White and black spots on display $\square 0.25\text{mm}$, no more than three white or black spots present. 2.2 Densely spaced: No more than two spots or lines within 3mm. | 2.5 |

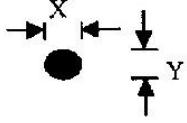
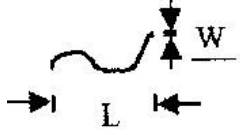
| NO | Item | Criterion | AQL | | | | | | | | | | | | | | | | | | |
|----------------------------------------|------------------------------------------------------------------------------------------------------------------------------------------------------------------------------------------------------------------------------------------------------------------------------------------------------------------------------------------------------------------------------------------------------------------------------------------------------------------------------------------------------------------------------------------------------------------------------------------------------------------------------------------------------------------------------------|---------------------------------------------------------------------------------------------------------------------------------------------------------------------------------------------------------------------------------------------------------------------------------------------------------------------------------------------------------------------------------------------------------------------------------------------------------------------------------------------------------------------------------------------------------------------------------------------------------------------------------------------------------------------------------------------------------------------------------------|----------------|----------------|------|------------------|---------------|--------|-------------------------|--------------|----------------------|-------------------------|-----|--------------|----------------------|-----|------|------------|---------------|--|-----|
| 03 | OLED black spots, white spots, contamination (non-display) | 3.1 Round type : As following drawing $\Phi = (x + y) / 2$  <table border="1" data-bbox="715 546 1385 792"> <thead> <tr> <th>SIZE</th> <th>Acceptable QTY</th> <th>Zone</th> </tr> </thead> <tbody> <tr> <td>$\Phi \leq 0.10$</td> <td>ignore</td> <td>A+ B,</td> </tr> <tr> <td>$0.10 < \Phi \leq 0.20$</td> <td>2</td> <td>A+ B</td> </tr> <tr> <td>$0.20 < \Phi \leq 0.25$</td> <td>1</td> <td>A+ B</td> </tr> <tr> <td>$0.25 < \Phi$</td> <td>0</td> <td>A+ B</td> </tr> </tbody> </table> | SIZE | Acceptable QTY | Zone | $\Phi \leq 0.10$ | ignore | A+ B, | $0.10 < \Phi \leq 0.20$ | 2 | A+ B | $0.20 < \Phi \leq 0.25$ | 1 | A+ B | $0.25 < \Phi$ | 0 | A+ B | 2.5 | | | |
| | | SIZE | Acceptable QTY | Zone | | | | | | | | | | | | | | | | | |
| $\Phi \leq 0.10$ | ignore | A+ B, | | | | | | | | | | | | | | | | | | | |
| $0.10 < \Phi \leq 0.20$ | 2 | A+ B | | | | | | | | | | | | | | | | | | | |
| $0.20 < \Phi \leq 0.25$ | 1 | A+ B | | | | | | | | | | | | | | | | | | | |
| $0.25 < \Phi$ | 0 | A+ B | | | | | | | | | | | | | | | | | | | |
| 3.2 Line type : (As following drawing) |  <table border="1" data-bbox="587 1137 1385 1384"> <thead> <tr> <th>Length</th> <th>Width</th> <th>Acceptable QTY</th> <th>Zone</th> </tr> </thead> <tbody> <tr> <td>---</td> <td>$W \leq 0.02$</td> <td>ignore</td> <td>A+B</td> </tr> <tr> <td>$L \leq 3.0$</td> <td>$0.02 < W \leq 0.03$</td> <td rowspan="2">2</td> <td>A+B</td> </tr> <tr> <td>$L \leq 2.5$</td> <td>$0.03 < W \leq 0.05$</td> <td>A+B</td> </tr> <tr> <td>---</td> <td>$0.05 < W$</td> <td>As round type</td> <td></td> </tr> </tbody> </table> | Length | Width | Acceptable QTY | Zone | --- | $W \leq 0.02$ | ignore | A+B | $L \leq 3.0$ | $0.02 < W \leq 0.03$ | 2 | A+B | $L \leq 2.5$ | $0.03 < W \leq 0.05$ | A+B | --- | $0.05 < W$ | As round type | | 2.5 |
| Length | Width | Acceptable QTY | Zone | | | | | | | | | | | | | | | | | | |
| --- | $W \leq 0.02$ | ignore | A+B | | | | | | | | | | | | | | | | | | |
| $L \leq 3.0$ | $0.02 < W \leq 0.03$ | 2 | A+B | | | | | | | | | | | | | | | | | | |
| $L \leq 2.5$ | $0.03 < W \leq 0.05$ | | A+B | | | | | | | | | | | | | | | | | | |
| --- | $0.05 < W$ | As round type | | | | | | | | | | | | | | | | | | | |
| 04 | Polarizer bubbles /Dent | 4.1 If bubbles are visible, judge using black spot specifications, not easy to find, must check in specify direction. 4.2 The polarizer dent follows this specification. <table border="1" data-bbox="715 1518 1385 1765"> <thead> <tr> <th>Size Φ</th> <th>Acceptable QTY</th> <th>Zone</th> </tr> </thead> <tbody> <tr> <td>$\Phi \leq 0.20$</td> <td>ignore</td> <td>A+B</td> </tr> <tr> <td>$0.20 < \Phi \leq 0.50$</td> <td>3</td> <td>A+B</td> </tr> <tr> <td>$0.50 < \Phi \leq 1.00$</td> <td>2</td> <td>A+B</td> </tr> <tr> <td>$1.00 < \Phi$</td> <td>0</td> <td>A+B</td> </tr> <tr> <td>Total QTY</td> <td>3</td> <td></td> </tr> </tbody> </table> | Size Φ | Acceptable QTY | Zone | $\Phi \leq 0.20$ | ignore | A+B | $0.20 < \Phi \leq 0.50$ | 3 | A+B | $0.50 < \Phi \leq 1.00$ | 2 | A+B | $1.00 < \Phi$ | 0 | A+B | Total QTY | 3 | | 2.5 |
| Size Φ | Acceptable QTY | Zone | | | | | | | | | | | | | | | | | | | |
| $\Phi \leq 0.20$ | ignore | A+B | | | | | | | | | | | | | | | | | | | |
| $0.20 < \Phi \leq 0.50$ | 3 | A+B | | | | | | | | | | | | | | | | | | | |
| $0.50 < \Phi \leq 1.00$ | 2 | A+B | | | | | | | | | | | | | | | | | | | |
| $1.00 < \Phi$ | 0 | A+B | | | | | | | | | | | | | | | | | | | |
| Total QTY | 3 | | | | | | | | | | | | | | | | | | | | |
| 05 | Scratches | Follow NO.3 OLED black spots, white spots, contamination. | | | | | | | | | | | | | | | | | | | |

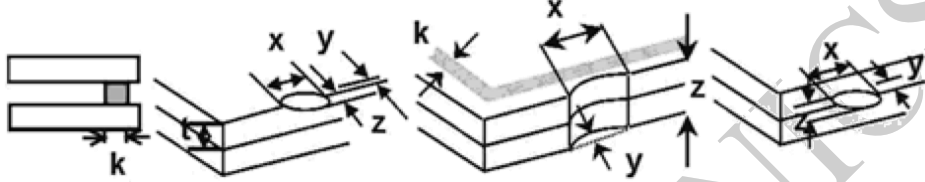
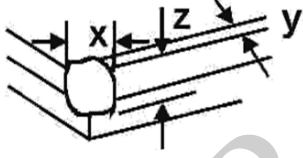
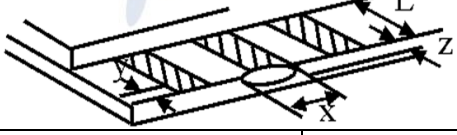
| NO | Item | Criterion | AQL | | | | | | | | | |
|-------------------------------------------------------------------------------------------------------------------------------------------------------------------------------------------------------------------------------------------------------------------------------------------------------------------------------------------------------------------------------------------------------------------------------------------------------------------------------------------------------------------------------------------------------------------------|-----------------------|--------------------------------------------------------------------------------------------------------------------------------------------------------------------------------------------------------------------------------------------------------------------------------------------------------------------------------------------------------------------------------------------------------------------------------------------------------------------------------------------------------------------------------------------------------------------------------------------------------------------------------------------------------------------------------------------------------------------------------------------------------------------------------------------------------------------------------------------------------------------------|-------------------|----------------|-----------------------|-----------------------|-----------------------|-----------------|--------------------|-----------------|---------------|-----|
| 06 | Chipped glass | <p>Symbols Define: x: Chip length y: Chip width z: Chip thickness k: Seal width t: Glass thickness a: OLED side length L: Electrode pad length: 6.1 General glass chip : 6.1.1 Chip on panel surface and crack between panels:</p>  <table border="1" data-bbox="438 918 1353 1041"> <tr> <td>z: Chip thickness</td> <td>y: Chip width</td> <td>x: Chip length</td> </tr> <tr> <td>$Z \leq 1/2t$</td> <td>Not over viewing area</td> <td>$x \leq 1/8a$</td> </tr> <tr> <td>$1/2t < z \leq 2t$</td> <td>Not exceed 1/3k</td> <td>$x \leq 1/8a$</td> </tr> </table> <p>⊙ If there are 2 or more chips, x is total length of each chip.</p> | z: Chip thickness | y: Chip width | x: Chip length | $Z \leq 1/2t$ | Not over viewing area | $x \leq 1/8a$ | $1/2t < z \leq 2t$ | Not exceed 1/3k | $x \leq 1/8a$ | 2.5 |
| | | z: Chip thickness | y: Chip width | x: Chip length | | | | | | | | |
| $Z \leq 1/2t$ | Not over viewing area | $x \leq 1/8a$ | | | | | | | | | | |
| $1/2t < z \leq 2t$ | Not exceed 1/3k | $x \leq 1/8a$ | | | | | | | | | | |
| <p>6.1.2 Corner crack:</p>  <table border="1" data-bbox="438 1361 1353 1485"> <tr> <td>z: Chip thickness</td> <td>y: Chip width</td> <td>x: Chip length</td> </tr> <tr> <td>$Z \leq 1/2t$</td> <td>Not over viewing area</td> <td>$x \leq 1/8a$</td> </tr> <tr> <td>$1/2t < z \leq 2t$</td> <td>Not exceed 1/3k</td> <td>$x \leq 1/8a$</td> </tr> </table> <p>⊙ If there are 2 or more chips, x is the total length of each chip.</p> | z: Chip thickness | y: Chip width | x: Chip length | $Z \leq 1/2t$ | Not over viewing area | $x \leq 1/8a$ | $1/2t < z \leq 2t$ | Not exceed 1/3k | $x \leq 1/8a$ | 2.5 | | |
| z: Chip thickness | y: Chip width | x: Chip length | | | | | | | | | | |
| $Z \leq 1/2t$ | Not over viewing area | $x \leq 1/8a$ | | | | | | | | | | |
| $1/2t < z \leq 2t$ | Not exceed 1/3k | $x \leq 1/8a$ | | | | | | | | | | |
| | Glass crack | <p>Symbols : x: Chip length y: Chip width z: Chip thickness k: Seal width t: Glass thickness a: OLED side length L: Electrode pad length 6.2 Protrusion over terminal : 6.2.1 Chip on electrode pad :</p>  <table border="1" data-bbox="438 1937 1353 2011"> <tr> <td>y: Chip width</td> <td>x: Chip length</td> <td>z: Chip thickness</td> </tr> <tr> <td>$y \leq 0.5\text{mm}$</td> <td>$x \leq 1/8a$</td> <td>$0 < z \leq t$</td> </tr> </table> | y: Chip width | x: Chip length | z: Chip thickness | $y \leq 0.5\text{mm}$ | $x \leq 1/8a$ | $0 < z \leq t$ | 2.5 | | | |
| y: Chip width | x: Chip length | z: Chip thickness | | | | | | | | | | |
| $y \leq 0.5\text{mm}$ | $x \leq 1/8a$ | $0 < z \leq t$ | | | | | | | | | | |

| NO | Item | Criterion | AQL | | | | | | | | | | |
|---------------|--------------------|----------------------------------------------------------------------------------------------------------------------------------------------------------------------------------------------------------------------------------------------------------------------------------------------------------------------------------------------------------------------------------------------------------------------------------------------------------------------------------------------------------------------------------------------------------------------------------------------------------------------------------------------------------------------------------------------------------------------------------------------------------------------------------------------------------------------------------------------------------|---------------------|----------------|-------------------|------------|---------------|----------------|----------|-----------|---------------|------------|-----|
| 06 | Glass crack | <p>6.2.2 Non-conductive portion:</p> <table border="1" data-bbox="512 728 1393 808"> <tr> <td>y: Chip width</td> <td>x: Chip length</td> <td>z: Chip thickness</td> </tr> <tr> <td>$y \leq L$</td> <td>$x \leq 1/8a$</td> <td>$0 < z \leq t$</td> </tr> </table> <ul style="list-style-type: none"> ⊙ If the chipped area touches the ITO terminal, over 2/3 of the ITO must remain and be inspected according to electrode terminal specifications. ⊙ If the product will be heat sealed by the customer, the alignment mark not be damaged. <p>6.2.3 Substrate protuberance and internal crack.</p> <table border="1" data-bbox="847 1093 1358 1173"> <tr> <td>y: width</td> <td>x: length</td> </tr> <tr> <td>$y \leq 1/3L$</td> <td>$x \leq a$</td> </tr> </table> | y: Chip width | x: Chip length | z: Chip thickness | $y \leq L$ | $x \leq 1/8a$ | $0 < z \leq t$ | y: width | x: length | $y \leq 1/3L$ | $x \leq a$ | 2.5 |
| y: Chip width | x: Chip length | z: Chip thickness | | | | | | | | | | | |
| $y \leq L$ | $x \leq 1/8a$ | $0 < z \leq t$ | | | | | | | | | | | |
| y: width | x: length | | | | | | | | | | | | |
| $y \leq 1/3L$ | $x \leq a$ | | | | | | | | | | | | |
| 07 | Cracked glass | The OLED with extensive crack is not acceptable. | 2.5 | | | | | | | | | | |
| 08 | Backlight elements | <p>8.1 Illumination source flickers when lit.</p> <p>8.2 Spots or scratched that appear when lit must be judged. Using OLED spot, lines and contamination standards.</p> <p>8.3 Backlight doesn't light or color wrong.</p> | 0.65 2.5 0.65 | | | | | | | | | | |
| 09 | Bezel | <p>9.1 Bezel may not have rust, be deformed or have fingerprints, stains or other contamination.</p> <p>9.2 Bezel must comply with job specifications.</p> | 2.5 0.65 | | | | | | | | | | |

| NO | Item | Criterion | AQL |
|----|--------------------|----------------------------------------------------------------------------------------------------------------------------------------------|------|
| 10 | PCB , COB | 10.1 COB seal may not have pinholes larger than 0.2mm or contamination. | 2.5 |
| | | 10.2 COB seal surface may not have pinholes through to the IC. | 2.5 |
| | | 10.3 The height of the COB should not exceed the height indicated in the assembly diagram. | 0.65 |
| | | 10.4 There may not be more than 2mm of sealant outside the seal area on the PCB. And there should be no more than three places. | 2.5 |
| | | 10.5 No oxidation or contamination PCB terminals. | 2.5 |
| | | 10.6 Parts on PCB must be the same as on the production characteristic chart. There should be no wrong parts, missing parts or excess parts. | 0.65 |
| | | 10.7 The jumper on the PCB should conform to the product characteristic chart. | 0.65 |
| | | 10.8 If solder gets on bezel tab pads, OLED pad, zebra pad or screw hold pad, make sure it is smoothed down. | 2.5 |
| 11 | Soldering | 11.1 No un-melted solder paste may be present on the PCB. | 2.5 |
| | | 11.2 No cold solder joints, missing solder connections, oxidation or icicle. | 2.5 |
| | | 11.3 No residue or solder balls on PCB. | 2.5 |
| | | 11.4 No short circuits in components on PCB. | 0.65 |
| 12 | General appearance | 12.1 No oxidation, contamination, curves or, bends on interface Pin (OLB) of TCP. | 2.5 |
| | | 12.2 No cracks on interface pin (OLB) of TCP. | 0.65 |
| | | 12.3 No contamination, solder residue or solder balls on product. | 2.5 |
| | | 12.4 The IC on the TCP may not be damaged, circuits. | 2.5 |
| | | 12.5 The uppermost edge of the protective strip on the interface pin must be present or look as if it cause the interface pin to sever. | 2.5 |
| | | 12.6 The residual rosin or tin oil of soldering (component or chip component) is not burned into brown or black color. | 2.5 |
| | | 12.7 Sealant on top of the ITO circuit has not hardened. | 2.5 |
| | | 12.8 Pin type must match type in specification sheet. | 0.65 |
| | | 12.9 OLED pin loose or missing pins. | 0.65 |
| | | 12.10 Product packaging must the same as specified on packaging specification sheet. | 0.65 |
| | | 12.11 Product dimension and structure must conform to product specification sheet. | 0.65 |

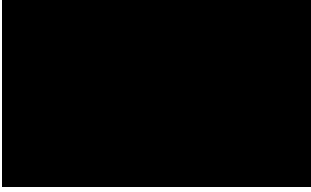
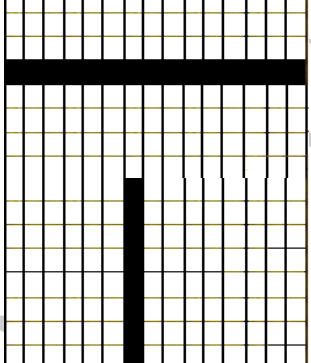
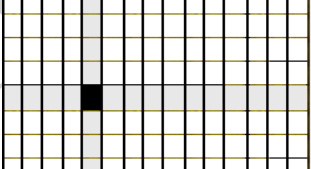
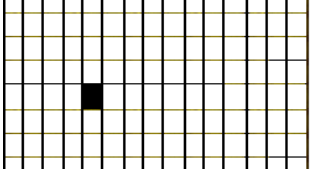
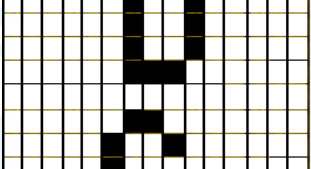
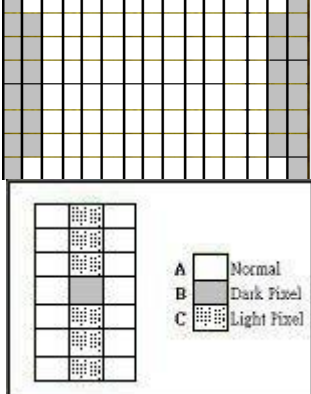
| Check Item | Classification | Criteria |
|----------------------------------------------------------------------|----------------|---------------------------------------------------------------------------------------|
| No Display | Major |  |
| Missing Line | Major |  |
| Pixel Short | Major |  |
| Darker Short | Major |  |
| Wrong Display | Major |  |
| Un-uniform $B/A \times 100\% < 70\%$ $A/C \times 100\% < 70\%$ | Major |  |

11. Precautions in use of OLED Modules

Modules

- (1) Avoid applying excessive shocks to module or making any alterations or modifications to it.
- (2) Don't make extra holes on the printed circuit board, change the components or modify its shape of OLED display module.
- (3) Don't disassemble the OLED display module.
- (4) Do not apply input signals while the logic power is off.
- (5) Don't operate it above the absolute maximum rating.
- (6) Don't drop, bend or twist OLED display module.
- (7) Soldering: only to the I/O terminals.
- (8) Hot-Bar FPC soldering condition: 280~350C, less than 5 seconds.
- (9) Raystar has the right to change the passive components (Resistors, capacitors and other passive components will have different appearance and color caused by the different supplier.) and change the PCB Rev. (In order to satisfy the supplying stability, management optimization and the best product performance...etc, under the premise of not affecting the electrical characteristics and external dimensions, Raystar have the right to modify the version.)
- (10) Raystar has the right to upgrade or modify the product function.
- (11) For COG & COF structure OLED products, customers should reserve VCC (VPP) adjustment function or software update function when designing OLED supporting circuit. (The progress of OLED light-emitting materials will increase the conversion efficiency and the brightness. The brightness can be adjusted if necessary)..

11.1. Handling Precautions

- (1) Since the display panel is being made of glass, do not apply mechanical impacts such as dropping from a high position.
- (2) If the display panel is broken by some accident and the internal organic substance leaks out, be careful not to inhale nor lick the organic substance.
- (3) If pressure is applied to the display surface or its neighborhood of the OLED display module, the cell structure may be damaged. So, be careful not to apply pressure to these sections.
- (4) The polarizer covering the surface of the OLED display module is soft and easily scratched.
- (5) When the surface of the polarizer of the OLED display module has soil, clean the surface. It takes advantage by using following adhesion tape.
 - * Scotch Mending Tape No. 810 or an equivalentNever try to breathe upon the soiled surface nor wipe the surface using cloth containing solvent such as ethyl alcohol, since the surface of the polarizer will become cloudy. Also, pay attention that the following liquid and solvent may spoil the polarizer:
 - * Water
 - * Ketone
 - * Aromatic Solvents
- (6) Protection film is being applied to the surface of the display panel and removes the protection film before assembling it. At this time, if the OLED display module has been stored for a long period of time, residue adhesive material of the protection film may remain on the surface of the display panel after removed of the film. In such case, remove the residue material by the method introduced in the above Section 5.
- (7) Do not touch the following sections whenever possible while handling the OLED display modules.

- * Pins and electrodes
- * Pattern layouts such as the TCP & FPC

- (8) Hold OLED display module very carefully when placing OLED display module into the System housing. Do not apply excessive stress or pressure to OLED display module. And, do not over bend the film with electrode pattern layouts. These stresses will influence the display performance. Also, secure sufficient rigidity for the outer cases.

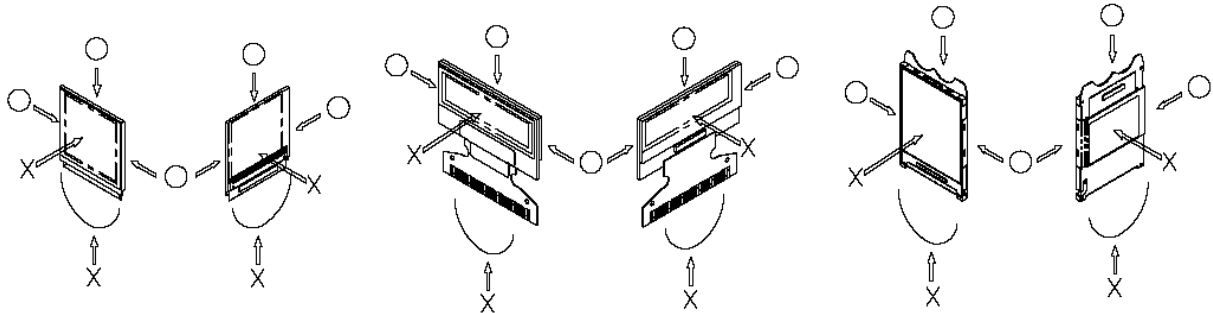

- (9) Do not apply stress to the LSI chips and the surrounding molded sections.
- (10) Pay sufficient attention to the working environments when handing OLED display modules to prevent occurrence of element breakage accidents by static electricity.
- * Be sure to make human body grounding when handling OLED display modules.
 - * Be sure to ground tools to use or assembly such as soldering irons.
 - * To suppress generation of static electricity, avoid carrying out assembly work under dry environments.
 - * Protective film is being applied to the surface of the display panel of the OLED display module. Be careful since static electricity may be generated when exfoliating the protective film.

11.2. Storage Precautions

- (1) When storing OLED display modules, put them in static electricity preventive bags to avoid be directly exposed to sun or lights of fluorescent lamps. And, also, place in the temperature $25\pm 5^{\circ}\text{C}$ and Humidity below 65% RH. (We recommend you to store these modules in the packaged state when they were shipped from Raystar. At that time, be careful not to let water drops adhere to the packages or bags.)
- (2) When the OLED display module is being dewed or when it is placed under high temperature or high humidity environments, the electrodes may be corroded if electric current is applied. Please store it in clean environment.

11.3. Designing Precautions

- (1) The absolute maximum ratings are the ratings which cannot be exceeded for OLED display module, and if these values are exceeded, OLED display module may be damaged.
- (2) To prevent occurrence of malfunctioning by noise, pay attention to satisfy the VIL and VIH specification and to make the signal line cable as short as possible.
- (3) We recommend you to install excess current preventive unit (fuses, etc.) to the power circuit (VDD / VCC). (Recommend value: 0.5A)
- (4) Pay sufficient attention to avoid occurrence of mutual noise interference with the nearby devices.
- (5) As for EMI, take necessary measures on the equipment side basically.

- (6) If the power supplied to the OLED display module is forcibly shut down by such errors as taking out the main battery while the OLED display panel is in operation, we cannot guarantee the quality of this OLED display module.
* Connection (contact) to any other potential than the above may lead to rupture of the IC.
- (7) If this OLED driver is exposed to light, malfunctioning may occur and semiconductor elements may change their characteristics.
- (8) The internal status may be changed, if excessive external noise enters into the module. Therefore, it is necessary to take appropriate measures to suppress noise generation or to protect module from influences of noise on the system design.
- (9) We recommend you to make periodical refreshment of the operation statuses (re-setting of the commands and re-transference of the display data) to cope with catastrophic noise.
- (10) It's pretty common to use "Screen Saver" to extend the lifetime and Don't use the same image for long time in real application. When an OLED display module is operated for a long of time with fixed pattern, an afterimage or slight contrast deviation may occur.
- (11) The limitation of FPC and Film bending.

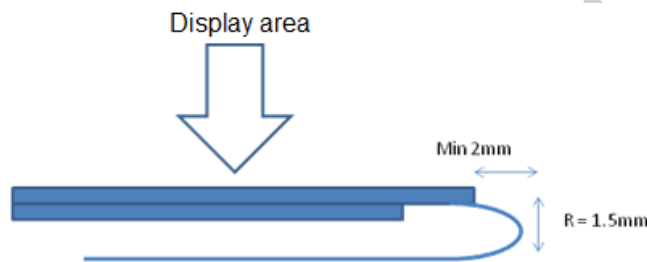

- (12) The module should be fixed balanced into the housing, or the module may be twisted.

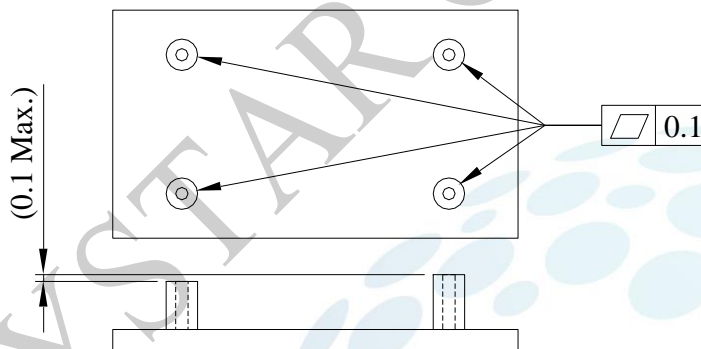

- (13) Please heat up a little the tape sticking on the components when removing it; otherwise the components might be damaged.

11.4. Precautions when disposing of the OLED display modules

- (1) Request the qualified companies to handle industrial wastes when disposing of the OLED display modules. Or, when burning them, be sure to observe the environmental and hygienic laws and regulations.

Module Sample Estimate Feedback Sheet

Module Number : _____

1 、 Panel Specification :

| | | |
|----------------------------|-------------------------------|-------------------------------------|
| 1. Panel Type : | <input type="checkbox"/> Pass | <input type="checkbox"/> NG , _____ |
| 2. Numbers of Pixel : | <input type="checkbox"/> Pass | <input type="checkbox"/> NG , _____ |
| 3. View Area : | <input type="checkbox"/> Pass | <input type="checkbox"/> NG , _____ |
| 4. Active Area : | <input type="checkbox"/> Pass | <input type="checkbox"/> NG , _____ |
| 5. Emitting Color : | <input type="checkbox"/> Pass | <input type="checkbox"/> NG , _____ |
| 6. Uniformity : | <input type="checkbox"/> Pass | <input type="checkbox"/> NG , _____ |
| 7. Operating Temperature : | <input type="checkbox"/> Pass | <input type="checkbox"/> NG , _____ |
| 8. Storage Temperature : | <input type="checkbox"/> Pass | <input type="checkbox"/> NG , _____ |
| 9. Others : _____ | | |

2 、 Mechanical Specification :

| | | |
|-----------------------------|-------------------------------|-------------------------------------|
| 1. PCB Size : | <input type="checkbox"/> Pass | <input type="checkbox"/> NG , _____ |
| 2. Frame Size : | <input type="checkbox"/> Pass | <input type="checkbox"/> NG , _____ |
| 3. Material of Frame : | <input type="checkbox"/> Pass | <input type="checkbox"/> NG , _____ |
| 4. Connector Position : | <input type="checkbox"/> Pass | <input type="checkbox"/> NG , _____ |
| 5. Fix Hole Position : | <input type="checkbox"/> Pass | <input type="checkbox"/> NG , _____ |
| 6. Thickness of PCB : | <input type="checkbox"/> Pass | <input type="checkbox"/> NG , _____ |
| 7. Height of Frame to PCB : | <input type="checkbox"/> Pass | <input type="checkbox"/> NG , _____ |
| 8. Height of Module : | <input type="checkbox"/> Pass | <input type="checkbox"/> NG , _____ |
| 9. Others : _____ | | |

3 、 Relative Hole Size :

| | | |
|-----------------------------|-------------------------------|-------------------------------------|
| 1. Pitch of Connector : | <input type="checkbox"/> Pass | <input type="checkbox"/> NG , _____ |
| 2. Hole size of Connector : | <input type="checkbox"/> Pass | <input type="checkbox"/> NG , _____ |
| 3. Mounting Hole size : | <input type="checkbox"/> Pass | <input type="checkbox"/> NG , _____ |
| 4. Mounting Hole Type : | <input type="checkbox"/> Pass | <input type="checkbox"/> NG , _____ |
| 5. Others : _____ | | |

>> Go to page 2 <<

| | | |
|------------------------------------------------------------------------------------------------------------------------------------------|-------------------------------|-------------------------------------|
| Module Number : _____ | | |
| 4 、 <u>Electronic Characteristics of Module</u> : | | |
| 1.Input Voltage : | <input type="checkbox"/> Pass | <input type="checkbox"/> NG , _____ |
| 2.Supply Current : | <input type="checkbox"/> Pass | <input type="checkbox"/> NG , _____ |
| 3.Driving Voltage for OLED : | <input type="checkbox"/> Pass | <input type="checkbox"/> NG , _____ |
| 4.Contrast for OLED : | <input type="checkbox"/> Pass | <input type="checkbox"/> NG , _____ |
| 5.Negative Voltage Output : | <input type="checkbox"/> Pass | <input type="checkbox"/> NG , _____ |
| 6.Interface Function : | <input type="checkbox"/> Pass | <input type="checkbox"/> NG , _____ |
| 7.ESD test : | <input type="checkbox"/> Pass | <input type="checkbox"/> NG , _____ |
| 8.Others : | <input type="checkbox"/> Pass | <input type="checkbox"/> NG , _____ |
| 5 、 <u>Summary</u> : | | |
| <p>Sales signature : _____</p> <p>Customer Signature : _____</p> <p style="text-align: right;">Date : / /</p> | | |

X-ON Electronics

Largest Supplier of Electrical and Electronic Components

Click to view similar products for [OLED Displays & Accessories](#) category:

Click to view products by [Raystar](#) manufacturer:

Other Similar products are found below :

[OLED-100H008A-RPP5N00000](#) [OLED-100H016B-RPP5N00000](#) [OLED-200H016A-LPP5N00000](#) [OLED-100H008A-GPP5N00000](#) [OLED-100H008A-LPP5N00000](#) [OLED-100H032A-BPP5N00000](#) [UG-2864KSWLG01](#) [DEP 128160A-W](#) [OLED-100H016F-RPP5N00000](#) [OLED-100H016A-LPP5N00000](#) [OLED-128Y032A-WPP3N00000](#) [OLED-100H016A-WPP5N00000](#) [OLED-100H016H-GPP5N00000](#) [OLED-016O002B-BPP5N00000](#) [OLED-096Y064A-LPP3N00000](#) [OLED-096O064A-BPP3N00000](#) [OLED-128Y064C-LPP3N00000](#) [OLED-096Y064B-LPP3N00000](#) [OLED-128Y032A-LPP3N00000](#) [OLED-096Y064B-BPP3N00000](#) [REH012864KYPP3N00F00](#) [HDSP-U111-EG000](#) [REC001601BWPP5N00100](#) [REG010016FBPP5N00100](#) [REG010016FGPP5N00100](#) [REG010016FWPP5N00100](#) [REG010032AWPP5N00100](#) [REX064128AWPP3N0Y000](#) [14747](#) [REA160128AYPP3N00000](#) [REN025664DGPP3L00000](#) [REN025664DYPP3L00000](#) [104020248](#) [10451](#) [19750](#) [19376](#) [19299](#) [16103](#) [10507](#) [10444](#) [13992](#) [14657](#) [10514](#) [9085](#) [REG010008AGPP5N00000](#) [REG010008AWPP5N00000](#) [REG010016CRPP5N00000](#) [REG010016DBPP5N00000](#) [REG010016ERPP5N00000](#) [REG010032BYPP5N00000](#)