



RAYSTAR

RAYSTAR Optronics, Inc.  
曜凌光電股份有限公司



# 曜凌光電股份有限公司 Raystar Optronics, Inc.

42881台中市大雅區科雅路25號5樓  
5F, No. 25, Keya Road, Daya Dist., Taichung City 42881, Taiwan  
T : +886-4-2565-0761 | F : +886-4-2565-0760  
sales@raystar-optronics.com | www.raystar-optronics.com

## RFF700B4-AIW-DNS

### SPECIFICATION

CUSTOMER:

<b>APPROVED BY</b>	
<b>PCB VERSION</b>	
<b>DATE</b>	

FOR CUSTOMER USE ONLY

<b>SALES BY</b>	<b>APPROVED BY</b>	<b>CHECKED BY</b>	<b>PREPARED BY</b>

Release DATE:

TFT Display Inspection Specification: <https://www.raystar-optronics.com/download/products.htm>  
Precaution in use of TFT module: <https://www.raystar-optronics.com/download/declaration.htm>

## Revision History

VERSION	DATE	REVISED PAGE NO.	Note
0	2022/09/29		First issue

RAYSTAR OPTRONICS

# Contents

1. Module Classification Information
2. Summary
3. General Specifications
4. Interface
5. Contour Drawing
6. Block Diagram
7. Absolute Maximum Ratings
8. Electrical Characteristics
9. DC Characteristics
10. AC Characteristics
11. Optical Characteristics
12. Reliability
13. Touch Panel Information
14. Other

# 1.Module Classification Information

<b>R</b>	<b>F</b>	<b>F</b>	<b>70</b>	<b>0B4</b>	<b>-</b>	<b>A</b>	<b>I</b>	<b>W</b>	<b>-</b>	<b>D</b>	<b>N</b>	<b>S</b>
1	2	3	4	5	-	6	7	8	-	9	10	11

Item	Description	
1	R : Raystar Optronics Inc.	
2	Display Type : F→TFT Type, J→ Custom TFT	
3	Solution: A: 128x160    B:320x234    C:320x240    D:480x234    E:480x272 F:800x480    G:640x480    H:1024x600    I:320x480    J:240x320 K:1280x800    L:240x400    M:1024x768    N:128x128    O:480x800 P:640x320    Q:800x600    S:480x128    T:800x320	
4	Display Size : 7.0" TFT	
5	Version Code.	
6	Model Type: A : TFT LCD E : TFT+FR+CONTROL BOARD J : TFT+FR+A/D BOARD N : TFT+FR+A/D BOARD+CONTROL BOARD S : TFT+FR+POWER BOARD (DC TO DC) 1 : TFT+CONTROL BOARD	6 : TFT+FR H : TFT+D/V BOARD I : TFT+FR+D/V BOARD B : TFT+POWER BD
7	Polarizer Type, Temperature range, View direction	I→Transmissive, W. T, 6:00 ;    C→Transmissive, N. T, 6:00 L→Transmissive, W.T,12:00 ;    F→Transmissive, N.T,12:00 Y→Transmissive,W.T, IPS TFT ; A→Transmissive, N.T, IPS TFT Z→Transmissive, W.T, O-TFT R→Transmissive, Super W.T, O-TFT N→Transmissive, Super W.T, 6:00; Q→Transmissive, Super W.T, 12:00 V→Transmissive, Super W.T, VA TFT
8	Backlight	W : LED, White                      H : LED, High Light White F : CCFL, White
9	Driver Method	D: Digital    A: Analog    L : LVDS    M:MIPI
10	Interface	N : without control board    A : 8Bit    B : 16Bit S:SPI Interface    R: RS232    U:USB    I: I2C
11	TS	N : Without TS            S : resistive touch panel C : capacitive touch panel    capacitive touch panel (G-F-F) G : capacitive touch panel(G-G)

## 2.Summary

TFT 7.0" is a TN transmissive type color active matrix TFT liquid crystal display that uses amorphous silicon TFT as switching devices. This module is composed of a TFT\_LCD module, it is usually designed for industrial application and this module follows RoHS.

RAYSTAR OPTRONICS

---

### 3. General Specifications

- Size: 7.0 inch
- Dot Matrix: 800 x RGB x 480 (TFT) dots
- Module dimension: 165 x 100.0x 7.2 mm
- Active area: 154.08 x 85.92 mm
- Pixel Pitch: 0.1926 X 0.179 mm
- LCD type: TFT, Normally White, Transmissive
- View Direction: 12 o'clock
- Gray Scale Inversion Direction: 6 o'clock
- Aspect Ratio: 16:9
- Backlight Type: LED ,Normally White
- Color arrangement: RGB-STRIFE
- TFT Driver IC: HX8264 & HX8664 or Equivalent
- TFT interface: 24-bit RGB
- With /Without TP: With RTP
- Surface: Glare

\*Color tone slight changed by temperature and driving voltage.

## 4.Interface

### 4.1. LCM PIN Definition

Pin	Symbol	Function	Remark
1	VLED+	Power supply for backlight	
2	VLED+	Power supply for backlight	
3	VLED-	Backlight ground	
4	VLED-	Backlight ground	
5	GND	Power ground	
6	VCOM	Common voltage	
7	VCC	Power for Digital Circuit	
8	MODE	DE/SYNC mode select	Note 1
9	DE	Data Input Enable (DEN)	
10	VS	Vertical Sync Input (VSD)	
11	HS	Horizontal Sync Input (HSD)	
12	B7	Blue data(MSB)	
13	B6	Blue data	
14	B5	Blue data	
15	B4	Blue data	
16	B3	Blue data	
17	B2	Blue data	
18	B1	Blue data	Note 2
19	B0	Blue data(LSB)	Note 2
20	G7	Green data(MSB)	
21	G6	Green data	
22	G5	Green data	
23	G4	Green data	
24	G3	Green data	
25	G2	Green data	
26	G1	Green data	Note 2
27	G0	Green data(LSB)	Note 2
28	R7	Red data(MSB)	
29	R6	Red data	
30	R5	Red data	
31	R4	Red data	



32	R3	Red data	
33	R2	Red data	
34	R1	Red data	Note 2
35	R0	Red data(LSB)	Note 2
36	GND	Power Ground	
37	DCLK	Sample clock (CLKIN)	Note 3
38	GND	Power Ground	
39	L/R	Left / right selection	Note 4
40	U/D	Up/down selection	Note 5
41	VGH	Gate ON Voltage	
42	VGL	Gate OFF Voltage	
43	AVDD	Power for Analog Circuit	
44	RESET	Global reset pin.	Note 6
45	NC	No connection	
46	VCOM	Common Voltage	
47	DITHB	Dithering function	Note 7
48	GND	Power Ground	
49	NC	No connection	
50	NC	No connection	

I: input, O: output, P: Power

Note 1: When select DE mode, MODE="1", VS and HS must pull high.

When select SYNC mode, MODE= "0", DE must be grounded.

Note 2: When input 18 bits RGB data, the two low bits of R,G and B data must be grounded.

Note 3: Data shall be latched at the falling edge of DCLK.

Note 4: Selection of scanning mode

Setting of scan control input		Scanning direction
U/D	L/R	
L	H	Up to down, left to right
H	L	Down to up, right to left
L	L	Up to down, right to left
H	H	Down to up, left to right

Note 5: Definition of scanning direction.

Refer to the figure as below:

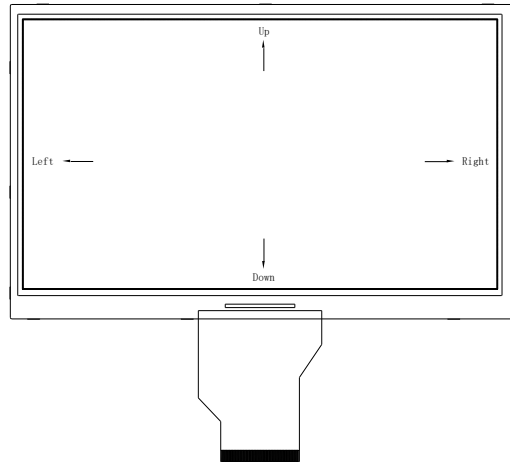

Note 6: Global reset pin. Active low to enter reset state . Suggest to connect with an RC reset circuit for stability. Normally pull high.

Note 7: Dithering function enable control, normally pull high.  
 When DITHB="1", Disable internal dithering function,  
 When DITHB="0", Enable internal dithering function,

RAYSTAR OPTROINCS

# 5. Contour Drawing

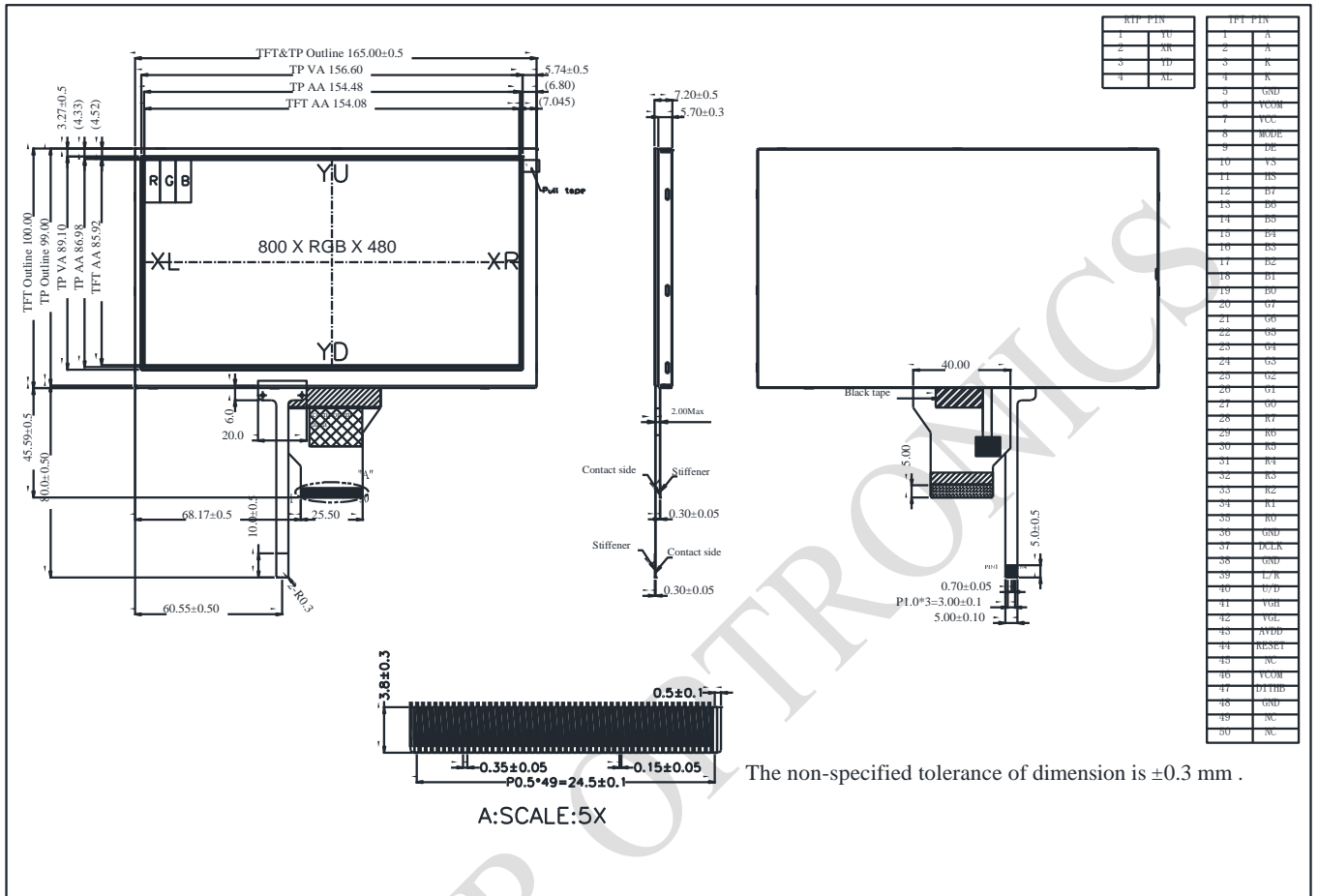

RTY PIN	TPY PIN
1	1U
2	2A
3	1D
4	AL

TPY PIN	TPY PIN
1	A
2	A
3	K
4	K
5	GND
6	VCOM
7	VCC
8	MODE
9	DE
10	VS
11	HS
12	DE
13	SP
14	BS
15	PI
16	BS
17	BZ
18	D1
19	BO
20	GT
21	GS
22	OS
23	OS
24	OS
25	PI
26	OS
27	RT
28	RT
29	BO
30	BS
31	RT
32	BS
33	RZ
34	RT
35	BO
36	GND
37	DETA
38	GND
39	L/R
40	L/R
41	VGH
42	VGL
43	AVDD
44	RES11
45	NC
46	VCOM
47	DT1HS
48	GND
49	NC
50	NC

## 6. Block Diagram

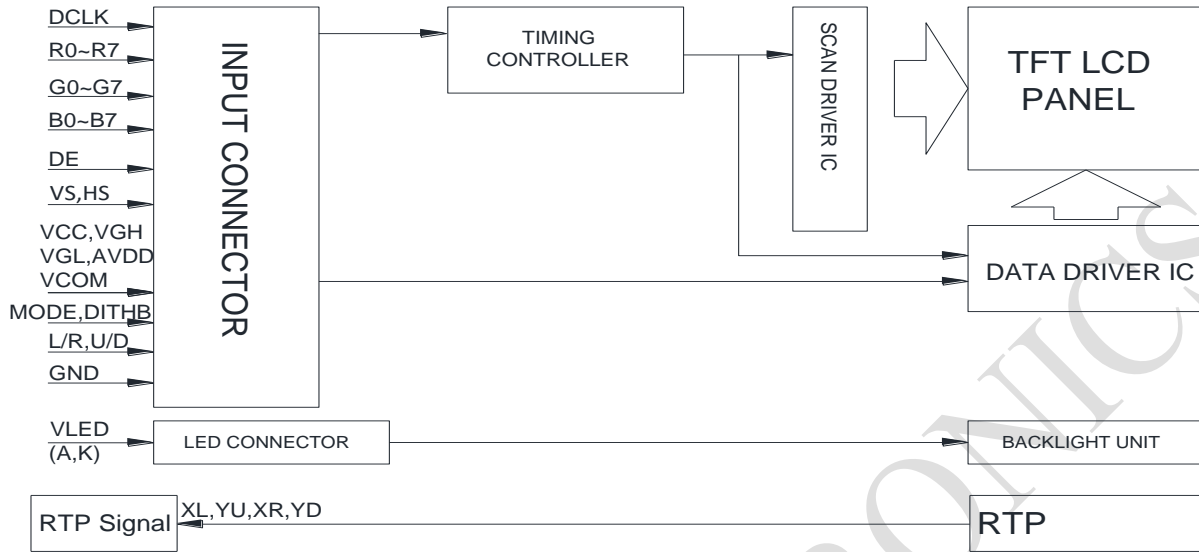

## 7. Absolute Maximum Ratings

Item	Symbol	Min	Typ	Max	Unit
Operating Temperature	TOP	-20	—	+70	□
Storage Temperature	TST	-30	—	+80	□

Note: Device is subject to be damaged permanently if stresses beyond those absolute maximum ratings listed above

- Temp. □60□, 90% RH MAX. Temp. >60□, Absolute humidity shall be less than 90% RH at 60□

RAYSTAR OPTRONICS

## 8. Electrical Characteristics

### 8.1. Operating conditions:

Item	Symbol	Min	Typ	Max	Unit	Remark
Supply Voltage For Logic	VCC	3.0	3.3	3.6	V	Note 2
Power voltage	AVDD	10.2	10.4	10.6	V	
Power Supply For Current	VCC =3.3V	-	4.3	-	mA	-
Power voltage	VGH	14.5	15.0	15.5	V	-
Power voltage	VGL	-10.5	-10	-9.5	V	-
Input signal voltage	VCOM	3.54	4.04	4.54	V	Note 4

Note 1: Be sure to apply VCC and VGL to the LCD first, and then apply VGH.

Note 2: VCC setting should match the signals output voltage (refer to Note 3) of customer's system board.

Note 3: DCLK,HS,VS,RESET,U/D, L/R,DE,R0~R7,G0~G7,B0~B7,MODE,DITHB.

Note 4: Typical VCOM is only a reference value. It must be optimized according to each LCM

### 8.2. LED driving conditions

Parameter	Symbol	Min.	Typ.	Max.	Unit	Remark
LED current	-	-	180	-	mA	-
LED voltage	VLED+	8.4	9.8	11.0	V	Note 1
LED Life Time	-		50,000	-	Hr	Note 2,3,4

Note 1 : There are 1 Groups LED

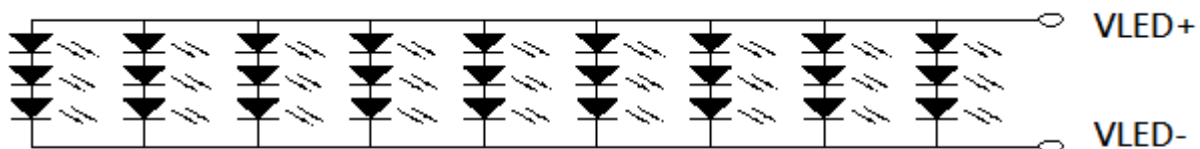

Backlight LED Circuit

Note 2 :  $T_a = 25\text{ }^\circ\text{C}$

Note 3 : Brightness to be decreased to 50% of the initial value

Note 4 : The single LED lamp case

## 9.DC Characteristics

Parameter	Symbol	Rating			Unit	Condition
		Min	Typ	Max		
Low level input voltage	$V_{IL}$	0	-	0.3VCC	V	
High level input voltage	$V_{IH}$	0.7VCC	-	VCC	V	

RAYSTAR OPTRONICS

# 10.AC Characteristics

## 10.1. AC Electrical Characteristics

Signal	Symbol	Min	Typ	Max	Unit
HS setup time	Thst	8	-	-	ns
HS hold time	Thhd	8	-	-	ns
VS setup time	Tvst	8	-	-	ns
VS hold time	Tvhd	8	-	-	ns
Data setup time	Tdsu	8	-	-	ns
Data hole time	Tdhd	8	-	-	ns
DE setup time	Tesu	8	-	-	ns
DE hole time	Tehd	8	-	-	ns
VCC Power On Slew rate	TPOR	-	-	20	ms
RESET pulse width	TRst	1	-	-	ms
DCLK cycle time	Tcoh	20	-	-	ns
DCLK pulse duty	Tcwh	40	50	60	%

## 10.2. Input Clock and Data Timing Diagram

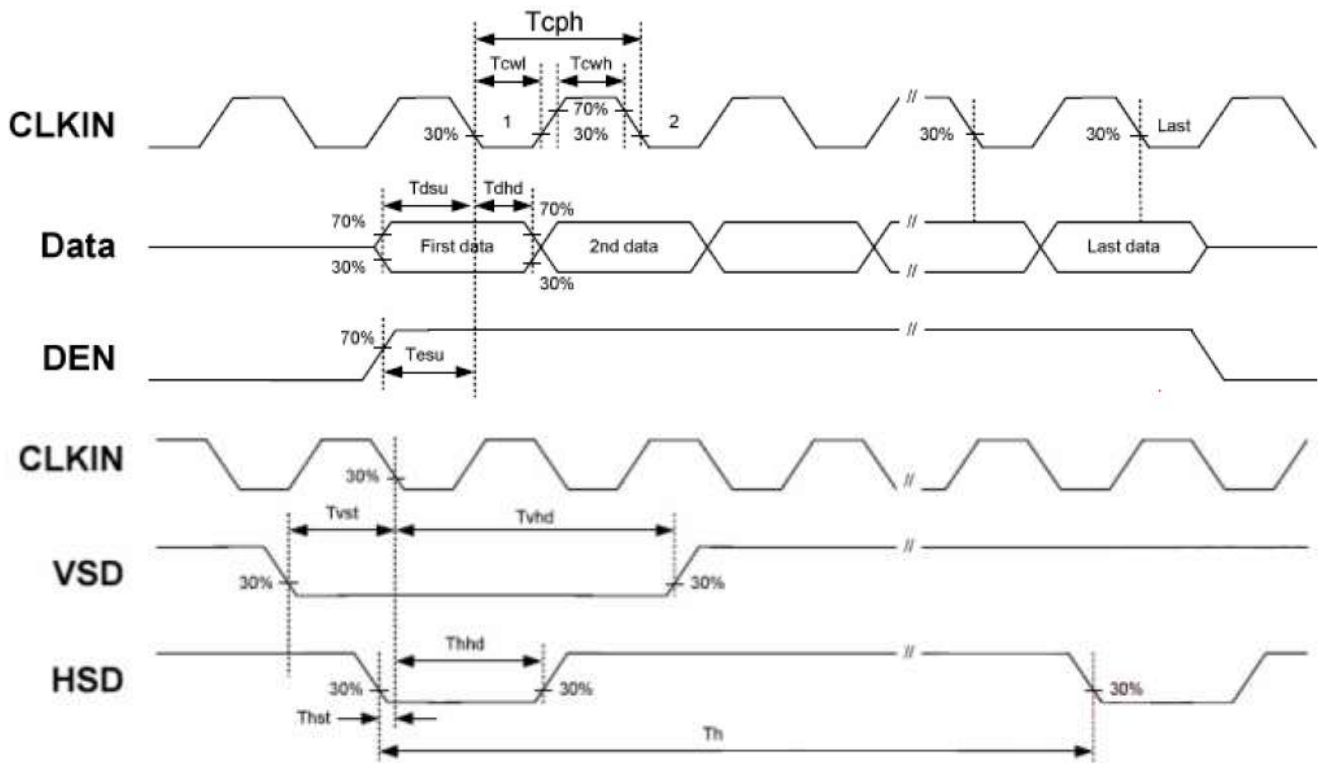



**10.3. Timing**

Item	Symbol	Values			Unit	Remark
		Min.	Typ.	Max.		
Horizontal Display Area	thd	-	800	-	DCLK	
DCLK Frequency	fclk	26.4	33.3	46.8	MHz	
One Horizontal Line	th	862	1056	1200	DCLK	
HS pulse width	thpw	1	-	40	DCLK	
HS Blanking	thb	-	46	-	DCLK	
HS Front Porch	thfp	16	210	354	DCLK	

Item	Symbol	Values			Unit	Remark
		Min.	Typ.	Max.		
Vertical Display Area	tvd	-	480	-	TH	
VS period time	tv	510	525	650	TH	
VS pulse width	tvpw	1	-	20	TH	
VS Blanking	tvb	-	23	-	TH	
VS Front Porch	tvfp	7	22	147	TH	

### 10.4. Data Input Format



Fig. Horizontal input timing diagram

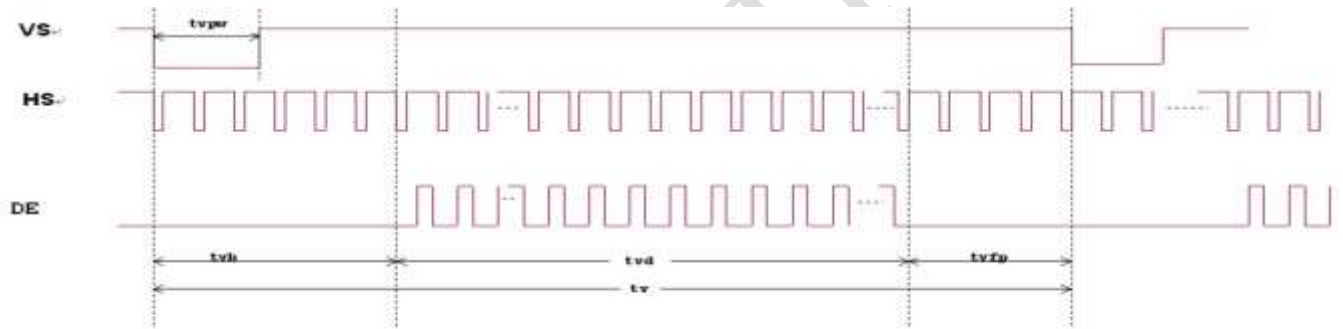

Fig. Vertical input timing diagram

# 11. Optical Characteristics

Item	Symbol	Condition.	Min	Typ.	Max.	Unit	Remark	
Response time	Tr+ Tf	$\theta=0^\circ$ 、 $\Phi=0^\circ$	-	25	50	.ms	Note 3	
Contrast ratio	CR	At optimized viewing angle	500	800	-	-	Note 4	
Color Chromaticity	White	Wx	$\theta=0^\circ$ 、 $\Phi=0$	0.26	0.31	0.36	-	Note 2,5,6
		Wy		0.28	0.33	0.38	-	
Viewing angle (Gray Scale Inversion Direction)	Hor.	$\Theta_R$	$CR \geq 10$	60	70	-	Deg.	Note 1
		$\Theta_L$		60	70	-		
	Ver.	$\Phi_T$		50	60	-		
		$\Phi_B$		60	70	-		
Brightness	-	-	200	250	-	cd/m <sup>2</sup>	Center of display	
Uniformity	(U)	-	70	-	-	%	Note 5	

Ta=25±2°C, IL=180mA

Note 1: Definition of viewing angle range

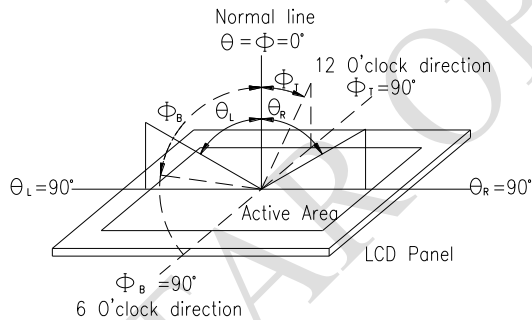

Fig. 11.1. Definition of viewing angle

Note 2: Test equipment setup:

After stabilizing and leaving the panel alone at a driven temperature for 10 minutes, the measurement should be executed. Measurement should be executed in a stable, windless, and dark room. Optical specifications are measured by Topcon BM-7orBM-5 luminance meter 1.0° field of view at a distance of 50cm and normal direction.

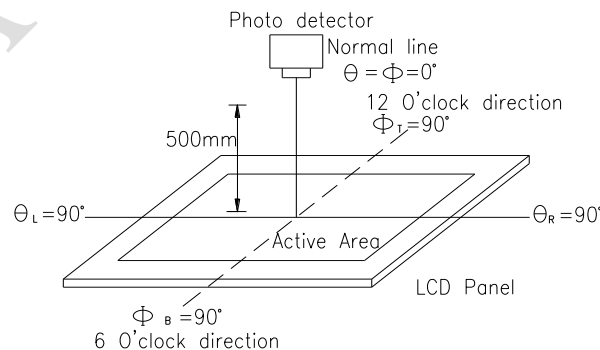
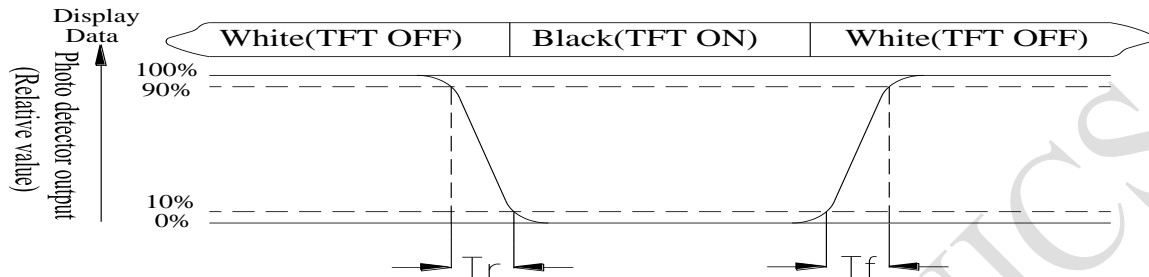

Fig. 11.2. Optical measurement system setup

Note 3: Definition of Response time:

The response time is defined as the LCD optical switching time interval between “White” state and “Black” state. Rise time,  $T_r$ , is the time between photo detector output intensity changed from 90% to 10%. And fall time,  $T_f$ , is the time between photo detector output intensity changed from 10% to 90%



Note 4: Definition of contrast ratio:

The contrast ratio is defined as the following expression.

$$\text{Contrast ratio (CR)} = \frac{\text{Luminance measured when LCD on the "White" state}}{\text{Luminance measured when LCD on the "Black" state}}$$

Note 5: Definition of Luminance Uniformity

Active area is divided into 9 measuring areas (reference the picture in below). Every measuring point is placed at the center of each measuring area.

$$\text{Luminance Uniformity (U)} = \text{Lmin/Lmax} \times 100\%$$

L = Active area length

W = Active area width

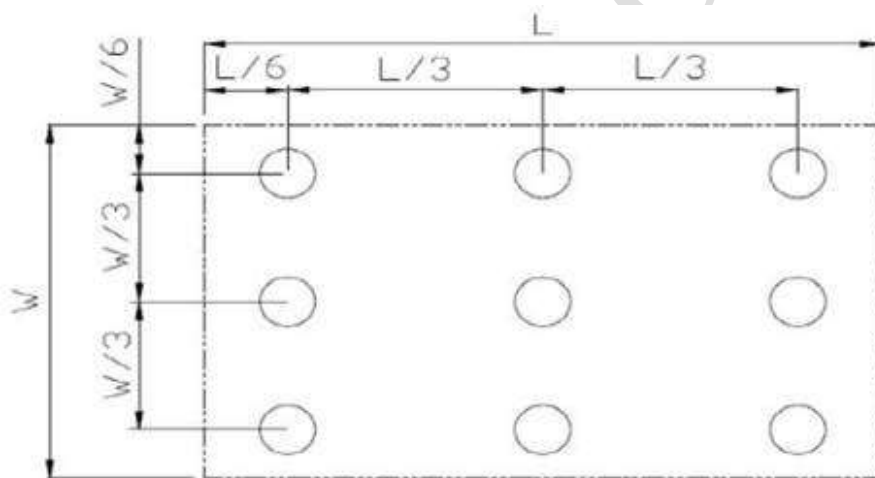

Fig11.3. Definition of uniformity

Note 6: Definition of color chromaticity (CIE 1931)

Color coordinates measured at the center point of LCD

Note 7: Measured at the center area of the panel when all the input terminals of LCD panel are electrically opened.

## 12. Reliability

Content of Reliability Test (Wide temperature, -20℃~70℃)

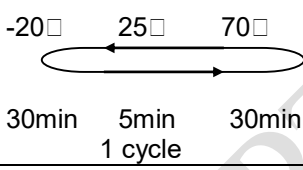
Environmental Test			
Test Item	Content of Test	Test Condition	Note
High Temperature storage	Endurance test applying the high storage temperature for a long time.	80℃ 200hrs	2
Low Temperature storage	Endurance test applying the low storage temperature for a long time.	-30℃ 200hrs	1,2
High Temperature Operation	Endurance test applying the electric stress (Voltage & Current) and the thermal stress to the element for a long time.	70℃ 200hrs	—
Low Temperature Operation	Endurance test applying the electric stress under low temperature for a long time.	-20℃ 200hrs	1
High Temperature/ Humidity Operation	The module should be allowed to stand at 60℃,90%RH max	60℃,90%RH 96hrs	1,2
Thermal shock resistance	The sample should be allowed stand the following 10 cycles of operation  <div style="text-align: center;">  <p>-20℃    25℃    70℃</p> <p>30min    5min    30min</p> <p>1 cycle</p> </div>	-20℃/70℃ 10 cycles	—
Vibration test	Endurance test applying the vibration during transportation and using.	Total fixed amplitude : 1.5mm Vibration Frequency : 10~55Hz One cycle 60 seconds to 3 directions of X,Y,Z for Each 15 minutes	3
Static electricity test	Endurance test applying the electric stress to the terminal.	VS=±600V(contact) ,±800v(air), RS=330Ω CS=150pF 10 times	—

Note1: No dew condensation to be observed.

Note2: The function test shall be conducted after 4 hours storage at the normal Temperature and humidity after remove from the test chamber.

Note3: The packing have to including into the vibration testing.

# 13.Touch Panel Information

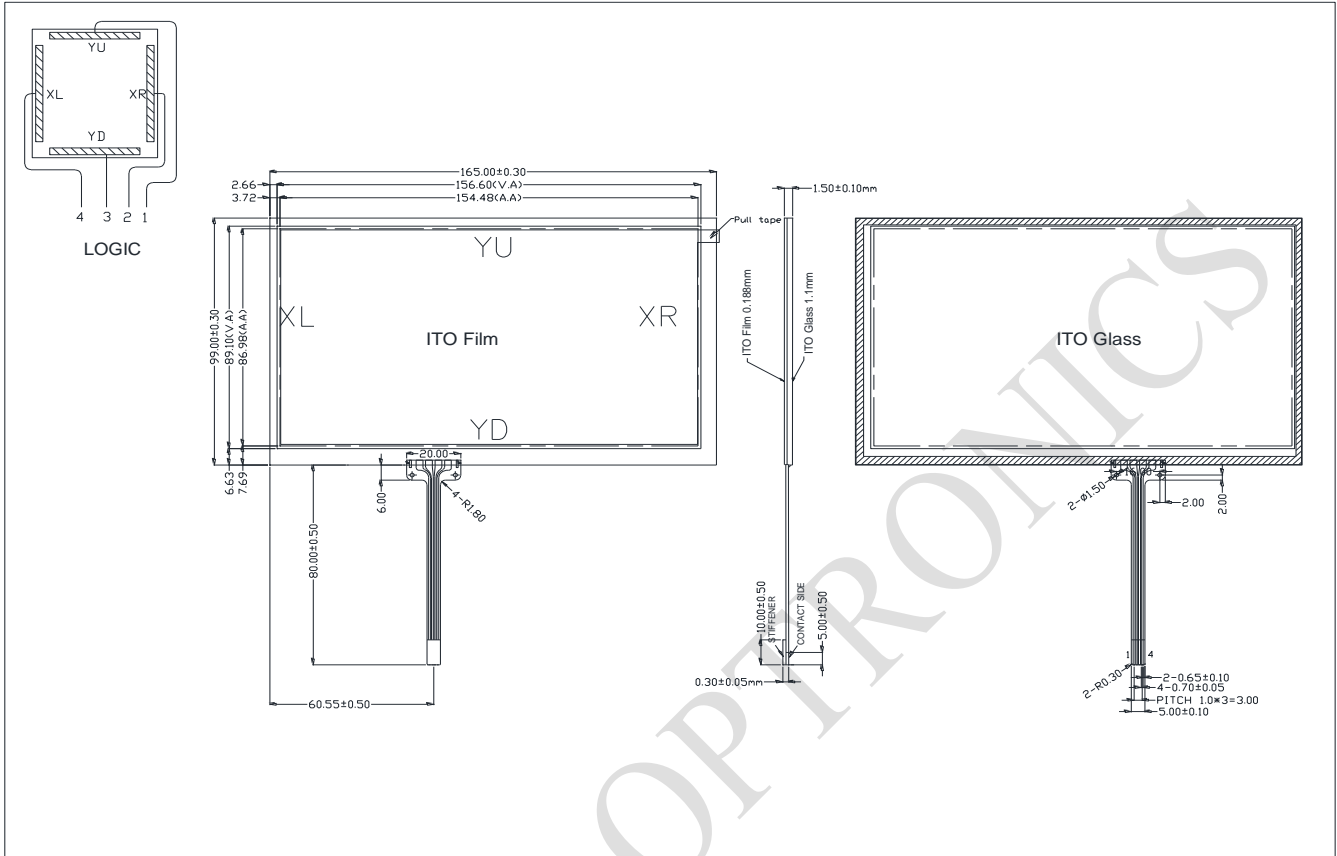

**13.1. Resistance Touch Panel General Specifications**

Item	Description
Driving condition	DC3~7V
Operating force	30~80g
Linearity max	$\leq \pm 1.5\%$
Insulating resistance	$> 10M\Omega \cdot 25V(DC)$
Light transparence	70%
Structure type	ITO Film/ITO Glass(F/G)
Surface Hardness	$\geq 3H$
Pen Hitting Durability (with the silicon rubber)	$> 1000,000$ times
X Axis resistance	430~910 $\Omega$
Y Axis resistance	150~530 $\Omega$

**LCM Sample Estimate Feedback Sheet**

**Module Number :** \_\_\_\_\_

**1 、 Panel Specification :**

1. Panel Type :	<input type="checkbox"/> Pass	<input type="checkbox"/> NG , _____
2. View Direction :	<input type="checkbox"/> Pass	<input type="checkbox"/> NG , _____
3. Numbers of Dots :	<input type="checkbox"/> Pass	<input type="checkbox"/> NG , _____
4. View Area :	<input type="checkbox"/> Pass	<input type="checkbox"/> NG , _____
5. Active Area :	<input type="checkbox"/> Pass	<input type="checkbox"/> NG , _____
6. Operating Temperature :	<input type="checkbox"/> Pass	<input type="checkbox"/> NG , _____
7. Storage Temperature :	<input type="checkbox"/> Pass	<input type="checkbox"/> NG , _____
8. Others :	_____	

**2 、 Mechanical Specification :**

1. PCB Size :	<input type="checkbox"/> Pass	<input type="checkbox"/> NG , _____
2. Frame Size :	<input type="checkbox"/> Pass	<input type="checkbox"/> NG , _____
3. Material of Frame :	<input type="checkbox"/> Pass	<input type="checkbox"/> NG , _____
4. Connector Position :	<input type="checkbox"/> Pass	<input type="checkbox"/> NG , _____
5. Fix Hole Position :	<input type="checkbox"/> Pass	<input type="checkbox"/> NG , _____
6. Backlight Position :	<input type="checkbox"/> Pass	<input type="checkbox"/> NG , _____
7. Thickness of PCB :	<input type="checkbox"/> Pass	<input type="checkbox"/> NG , _____
8. Height of Frame to PCB :	<input type="checkbox"/> Pass	<input type="checkbox"/> NG , _____
9. Height of Module :	<input type="checkbox"/> Pass	<input type="checkbox"/> NG , _____
10. Others :	<input type="checkbox"/> Pass	<input type="checkbox"/> NG , _____

**3 、 Relative Hole Size :**

1. Pitch of Connector :	<input type="checkbox"/> Pass	<input type="checkbox"/> NG , _____
2. Hole size of Connector :	<input type="checkbox"/> Pass	<input type="checkbox"/> NG , _____
3. Mounting Hole size :	<input type="checkbox"/> Pass	<input type="checkbox"/> NG , _____
4. Mounting Hole Type :	<input type="checkbox"/> Pass	<input type="checkbox"/> NG , _____
5. Others :	<input type="checkbox"/> Pass	<input type="checkbox"/> NG , _____

**4 、 Backlight Specification :**

1. B/L Type :	<input type="checkbox"/> Pass	<input type="checkbox"/> NG , _____
2. B/L Color :	<input type="checkbox"/> Pass	<input type="checkbox"/> NG , _____
3. B/L Driving Voltage (Reference for LED Type) :	<input type="checkbox"/> Pass	<input type="checkbox"/> NG , _____
4. B/L Driving Current :	<input type="checkbox"/> Pass	<input type="checkbox"/> NG , _____
5. Brightness of B/L :	<input type="checkbox"/> Pass	<input type="checkbox"/> NG , _____
6. B/L Solder Method :	<input type="checkbox"/> Pass	<input type="checkbox"/> NG , _____
7. Others :	<input type="checkbox"/> Pass	<input type="checkbox"/> NG , _____

>> Go to page 2 <<



**Module Number :** \_\_\_\_\_

**5 、 Electronic Characteristics of Module :**

1.Input Voltage :	<input type="checkbox"/> Pass	<input type="checkbox"/> NG , _____
2.Supply Current :	<input type="checkbox"/> Pass	<input type="checkbox"/> NG , _____
3.Driving Voltage for LCD :	<input type="checkbox"/> Pass	<input type="checkbox"/> NG , _____
4.Contrast for LCD :	<input type="checkbox"/> Pass	<input type="checkbox"/> NG , _____
5.B/L Driving Method :	<input type="checkbox"/> Pass	<input type="checkbox"/> NG , _____
6.Negative Voltage Output :	<input type="checkbox"/> Pass	<input type="checkbox"/> NG , _____
7.Interface Function :	<input type="checkbox"/> Pass	<input type="checkbox"/> NG , _____
8.LCD Uniformity :	<input type="checkbox"/> Pass	<input type="checkbox"/> NG , _____
9.ESD test :	<input type="checkbox"/> Pass	<input type="checkbox"/> NG , _____
10.Others :	<input type="checkbox"/> Pass	<input type="checkbox"/> NG , _____

**6 、 Summary :**
**Sales signature :** \_\_\_\_\_

**Customer Signature :** \_\_\_\_\_

**Date :**    /    /

## X-ON Electronics

Largest Supplier of Electrical and Electronic Components

*Click to view similar products for [TFT Displays & Accessories category](#):*

*Click to view products by [Raystar manufacturer](#):*

Other Similar products are found below :

[OAI-80038AA-2013-A](#) [HDA430T-3G1H](#) [T-51750GD065J-LW-BGN](#) [NB-ATT01](#) [NL8060BC26-35C](#) [TCG104SVLQAPNN-AN20](#) [OAI-80038AA-2008-A](#) [315-U004B15300](#) [EIC-LCD-1080P](#) [NL10276BC20-18C](#) [NLB121XG01L-01](#) [DEM 128160D](#) [TMH-PW-N](#) [RFE43BU-AIW-DNG](#) [RFC350X-AWW-DNG](#) [RFS390E-AWW-DNN](#) [DEM 480272G2](#) [VMX-PW-N \(A-TOUCH\)](#) [PH800480T013-ICA](#) [DEM 1024600N](#) [VMX-PW-N \(C-TOUCH\)](#) [DEM 1024600P](#) [VMH-PW-N \(C-TOUCH\)](#) [SM-RVT50HQHNWCA0](#) [DEM 240280A](#) [VMH-PW-N](#) [DEM 170320A](#) [VMH-PW-N](#) [PH240320T068-LAB08](#) [DEM 800480T1](#) [TMH-PW-N](#) [PH128128T041-LAA07](#) [DEM 800480Q4](#) [VMX-PW-N \(A-TOUCH\)](#) [PH480272T005-IAC02](#) [DEM 1024600P](#) [VMH-PW-N \(A-TOUCH\)](#) [DEM 800480T1](#) [TMH-PW-N \(C-TOUCH\)](#) [DEM 800480Q4](#) [VMX-PW-N](#) [DEM 800480T1](#) [TMH-PW-N \(A-TOUCH\)](#) [PH320240T-023-I02Q](#) [PH128800T004-ZZA01](#) [RFE430W-1YW-DBS](#) [DEM 1024600N](#) [VMX-PW-N \(A-TOUCH\)](#) [PH240320T074-ZAA01](#) [DEM 480480D](#) [VMX-PW-N \(C-TOUCH\)](#) [SM-RVT50HQSNWN00](#) [SM-RVT50HQHNWC00](#) [PH800480T033-ICB01](#) [RFE430W-AWW-DNN](#) [DEM 096096A](#) [VMH-PW-N](#) [RL0F00050000FGAAASA01](#) [PH320480T009-LAA01](#) [SM-RVT50HQSNWCA0](#) [SM-RVT50HQSNWC00-B](#) [PH320240T028-ZEA01](#) [RFE430W-1YW-DBN](#) [SM-RVT50HQLFWN00](#) [SM-RVT50HQHNWC00-B](#)