



RAYSTAR

曜凌光電股份有限公司

住址: 42878 台中市大雅区科雅路 25 號 5F WEB: <http://www.Raystar-Optronics.com>
5F., No.25, Keya Rd., Daya Dist., Taichung E-mail: sales@raystar-optronics.com
City 428, Taiwan Tel:886-4-2565-0761 Fax : 886-4-2565-0760

RFH700A7-AIW-LNN

SPECIFICATION

CUSTOMER:

APPROVED BY	
PCB VERSION	
DATE	

FOR CUSTOMER USE ONLY

SALES BY	APPROVED BY	CHECKED BY	PREPARED BY

Release DATE:

Revision History

VERSION	DATE	REVISED PAGE NO.	Note
0	2019/03/18		First issue
A	2019/04/11		Correct Control IC & Driver IC

RAYSTAR OPTRONICS

Contents

1. Module Classification Information
2. Summary
3. General Specification
4. Interface
5. Contour Drawing
6. Absolute Maximum Ratings
7. Electrical Characteristics
8. Operation Sequence
9. Optical Characteristics
10. Reliability
11. Other

2.Summary

TFT 7.0" is a TN transmissive type color active matrix TFT liquid crystal display that use amorphous silicon TFT as switching devices. This module is composed of a TFT_LCD module, it is usually designed for industrial application and this module follows RoHs.

RAYSTAR OPTRONICS

3.General Specifications

- Size: 7.0 inch
- Dot Matrix: 1024 x RGBx600(TFT) dots
- Module dimension: 164.8(W) x 99.8(H) x 5.65(D) mm
- Active area: 154.2144 x 85.92 mm
- Dot pitch: 0.1506 x 0.1432 mm
- LCD type: TFT, Normally White, Transmissive
- View Direction: 12 o'clock
- Gray Scale Inversion Direction: 6 o'clock
- Aspect Ratio: 16:9
- Backlight Type: LED, Normally White
- Control IC: NA
- Driver IC: EK79001HE + EK73215BCGA
- With /Without TP: Without TP
- Interface: LVDS
- Surface: Anti-Glare

*Color tone slight changed by temperature and driving voltage.

4.Interface

4.1. LCM PIN Definition

FPC Connector is used for the module electronics interface. The recommended model is FH12A-40S-0.5SH manufactured by Hirose.

Pin No.	Symbol	I/O	Function	Remark
1	VCOM	P	Common Voltage	
2	VDD	P	Digital circuit	
3	VDD	P	Digital circuit	
4	NC	---	No connection	
5	Reset	I	Global reset pin	
6	STBYB	I	Standby mode, Normally pulled high STBYB = "1", normal operation STBYB = "0", timing controller, source driver will turn off, all output are High-Z	
7	GND	P	Ground	
8	RXIN0-	I	Negative LVDS differential data input	
9	RXIN0+	I	Positive LVDS differential data input	
10	GND	P	Ground	
11	RXIN1-	I	Negative LVDS differential data input	
12	RXIN1+	I	Positive LVDS differential data input	
13	GND	P	Ground	
14	RXIN2-	I	Negative LVDS differential data input	
15	RXIN2+	I	Positive LVDS differential data input	
16	GND	P	Ground	
17	RXCLKIN-	I	Negative LVDS differential clock input	
18	RXCLKIN+	I	Positive LVDS differential clock input	
19	GND	P	Ground	
20	RXIN3-	I	Negative LVDS differential data input	
21	RXIN3+	I	Positive LVDS differential data input	
22	GND	P	Ground	
23	NC	---	No connection	

24	NC	---	No connection	
25	GND	P	Ground	
26	NC	---	No connection	
27	DIMO	O	Backlight CABC controller signal output	
28	SELB	I	6bit/8bit mode select H:6bit / L:8bit	
29	AVDD	P	Power for Analog Circuit	
30	GND	P	Ground	
31	LED-	P	LED Cathode	
32	LED-	P	LED Cathode	
33	L/R	I	Horizontal inversion	
34	U/D	I	Vertical inversion	
35	VGL	P	Negative power for TFT	
36	GND	P	Ground	
37	GND	P	Ground	
38	VGH	P	Positive power for TFT	
39	LED+	P	LED Anode	
40	LED+	P	LED Anode	

I:input ,O:output,P:power

Note

When L/R="0",set right to left scan direction.

When L/R="1",set left to right scan direction.

When U/D="0",set top to bottom scan direction.

When U/D="1",set bottom to top scan direction.

5. Contour Drawing

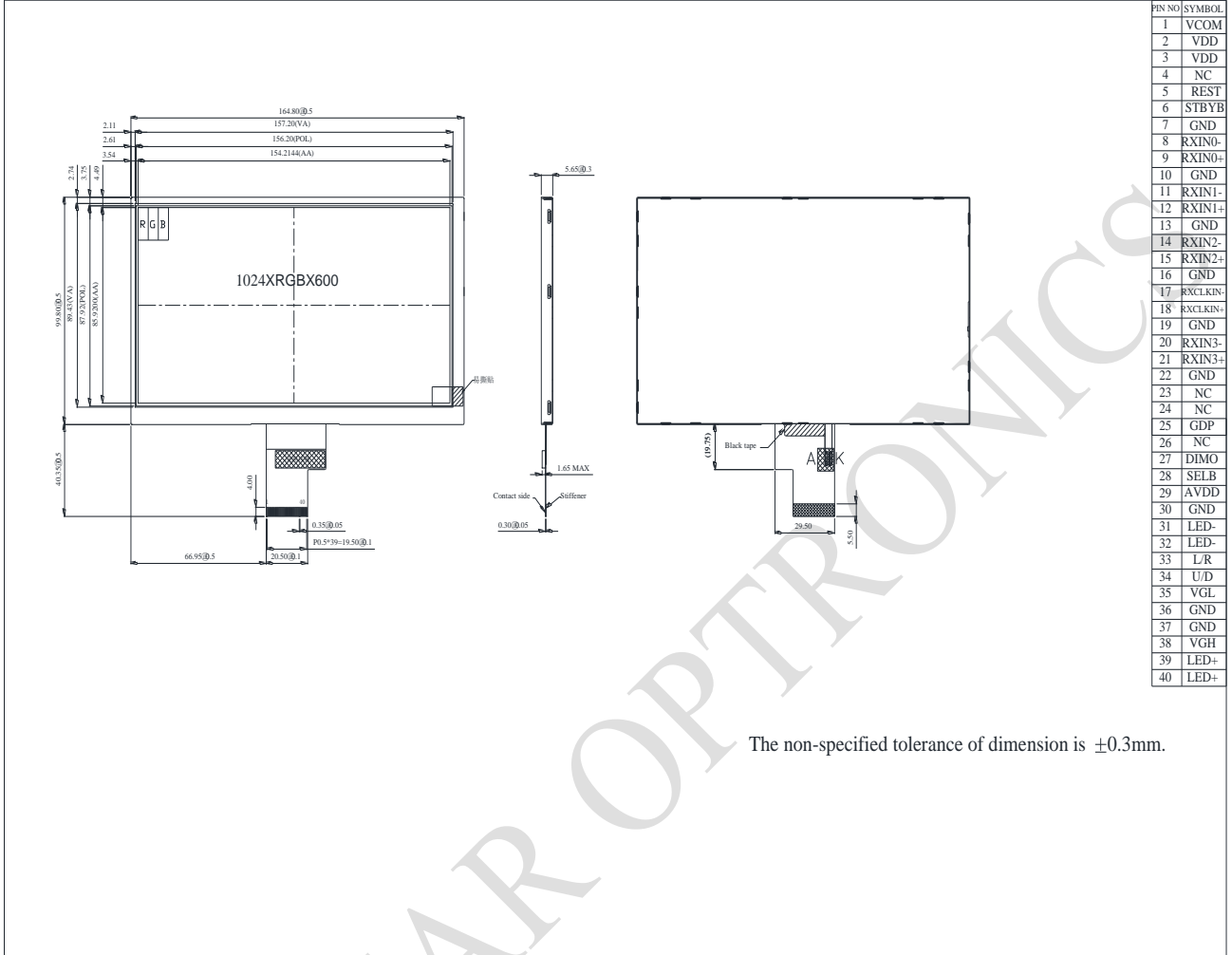

6. Absolute Maximum Ratings

Item	Symbol	Min	Typ	Max	Unit
Operating Temperature	TOP	-20	—	+70	°C
Storage Temperature	TST	-30	—	+80	°C

Note: Device is subject to be damaged permanently if stresses beyond those absolute maximum ratings listed above

1. Temp. $\leq 60^{\circ}\text{C}$, 90% RH MAX. Temp. $> 60^{\circ}\text{C}$, Absolute humidity shall be less than 90% RH at 60°C

RAYSTAR OPTRONICS

7. Electrical Characteristics

7.1. Typical Operation Conditions

(Note 1)

Item	Symbol	Values			Unit	Remark
		Min.	Typ.	Max.		
Power voltage	DVDD	3.0	3.3	3.6	V	Note 2
	AVDD	9.4	9.6	9.8	V	
	VGH	17	18	19	V	
	VGL	-6.6	-6.0	-5.4	V	
Input signal voltage	VCOM	3.1	3.3	3.6	V	
Input logic high voltage	VIH	0.7 DVDD	-	DVDD	V	Note 3
Input logic low voltage	VIL	0	-	0.3 DVDD	V	

Note 1: Be sure to apply DVDD and VGL to the LCD first, and then apply VGH.

Note 2: DVDD setting should match the signals output voltage (refer to Note 3) of customer's system board.

Note 3: DCLK, HS, VS, RESET, U/D, L/R, DE, R0~R7, G0~G7, B0~B7, MODE, DITHB.

7.2. Current Consumption

Item	Symbol	Values			Unit	Remark
		Min.	Typ.	Max.		
Current for Driver	IGH	-	0.2	1.0	mA	VGH = 18.0V
	IGL	-	0.2	1.0	mA	VGL = -6.0V
	IDVDD	-	4.0	10	mA	DVDD = 3.3V
	IAVDD	-	20	50	mA	AVDD = 9.6V

7.3. Backlight Driving Conditions

Item	Symbol	Values			Unit	Remark
		Min.	Typ.	Max.		
Voltage for LED backlight	VL	8.4	9.8	10.8	V	Note 1
Current for LED backlight	IL	--	300	--	mA	
LED life time	-	-	50,000	-	Hr	Note 2

Note 1: The LED Supply Voltage is defined by the number of LED at $T_a=25^\circ\text{C}$ and $I_L=300\text{mA}$.

Note 2: The "LED life time" is defined as the module brightness decrease to 50% original brightness at $T_a=25^\circ\text{C}$ and $I_L=300\text{mA}$. The LED lifetime could be decreased if operating I_L is larger than 300mA.

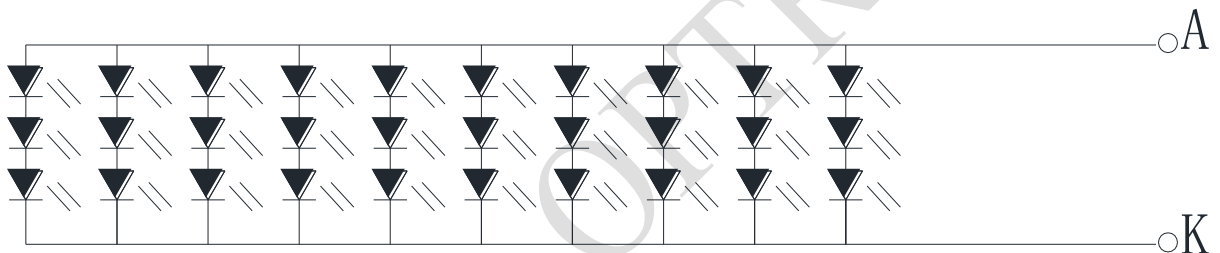

Backlight 30LED Circuit

8.Operation Sequence

8.1. Power Sequence

In order to prevent IC from power on reset fail, the time (TPOR) of the digital power supply VDD should be maintained within the given specifications. Refer to “AC characteristics” for more detail on timing.

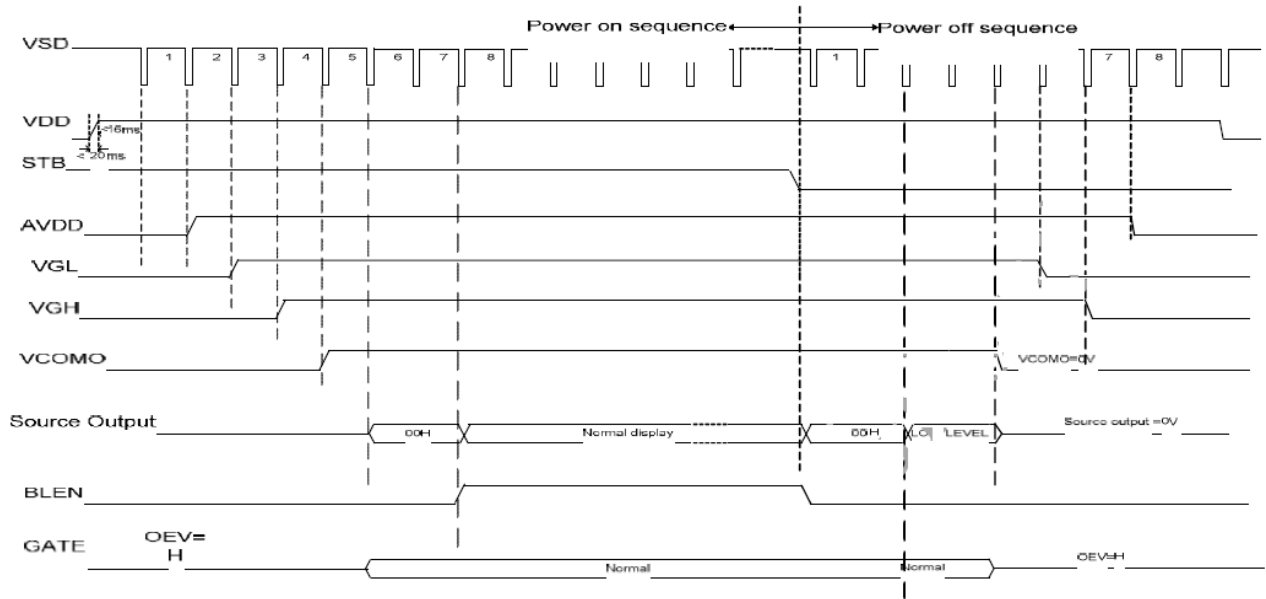

Power on/off timing chart

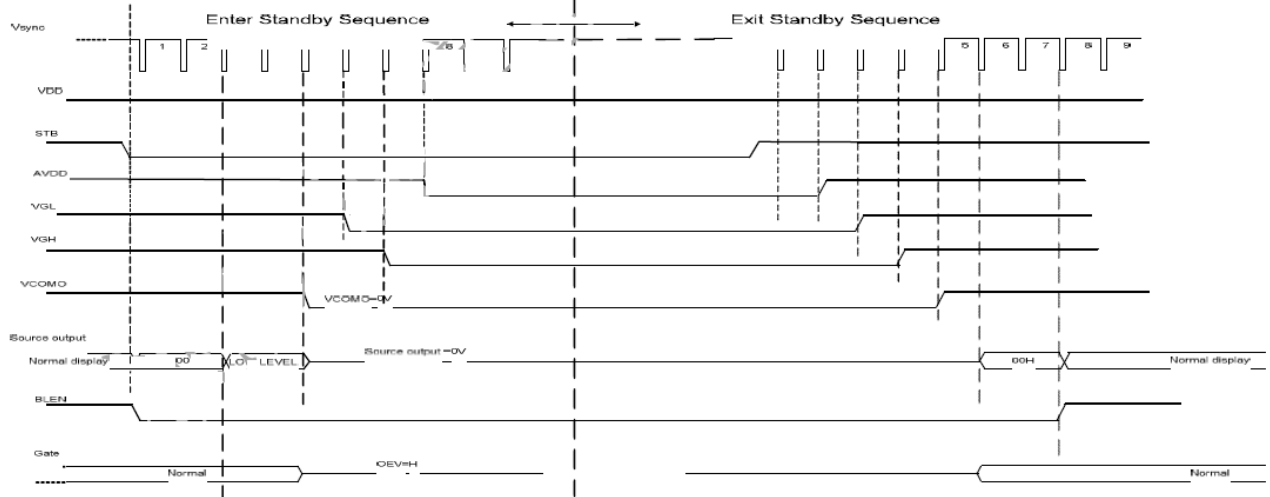

Enter and Exit standby Mode timing chart

Note : Low level=3Fh, when NBW=L (normally white)
 Low level=00h, when NBW=H (normally black)

8.2. Timing Characteristics
AC Electrical Characteristics

Parameter	Symbol	condition	Min.	Typ.	Max.	Unit
Clock frequency	RxFCLK		20	-	71	MHz
Input data skew margin	TRSKM	VID =400mV RxVCM=1.2V RxFCLK=71MHz	500	-	-	ps
Clock high time	TLVCH		-	4/(7* RxFCLK)	-	ns
Clock low time	TLVCL		-	3/(7* RxFCLK)	-	ns
PLL wake-up-time	TenPLL				150	us

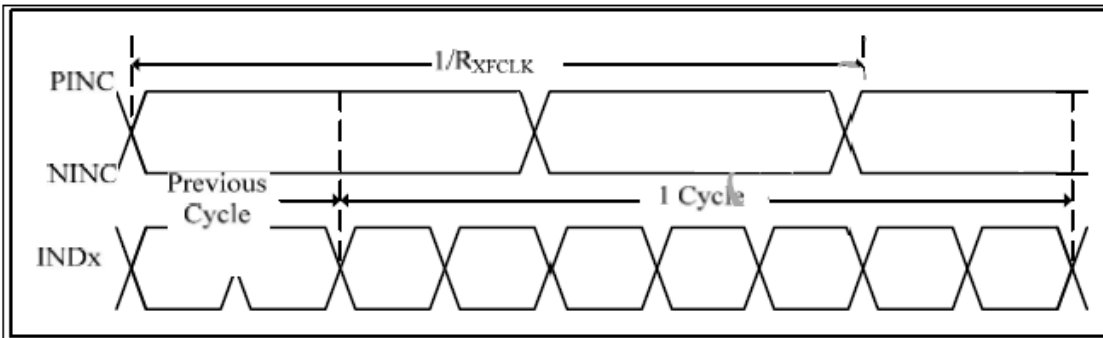

LVDS timing(1)

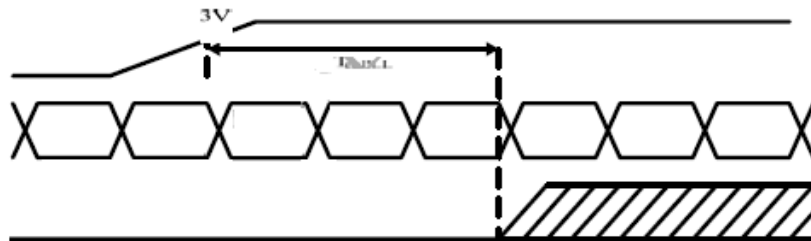

LVDS timing(2)

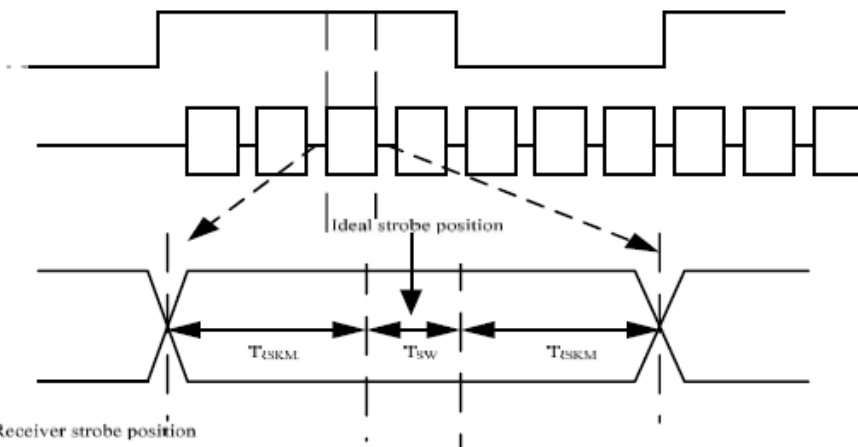

T_{SW}:Receiver strobe position
T_{RSKM}:Receiver strobe margin

LVDS timing(3)

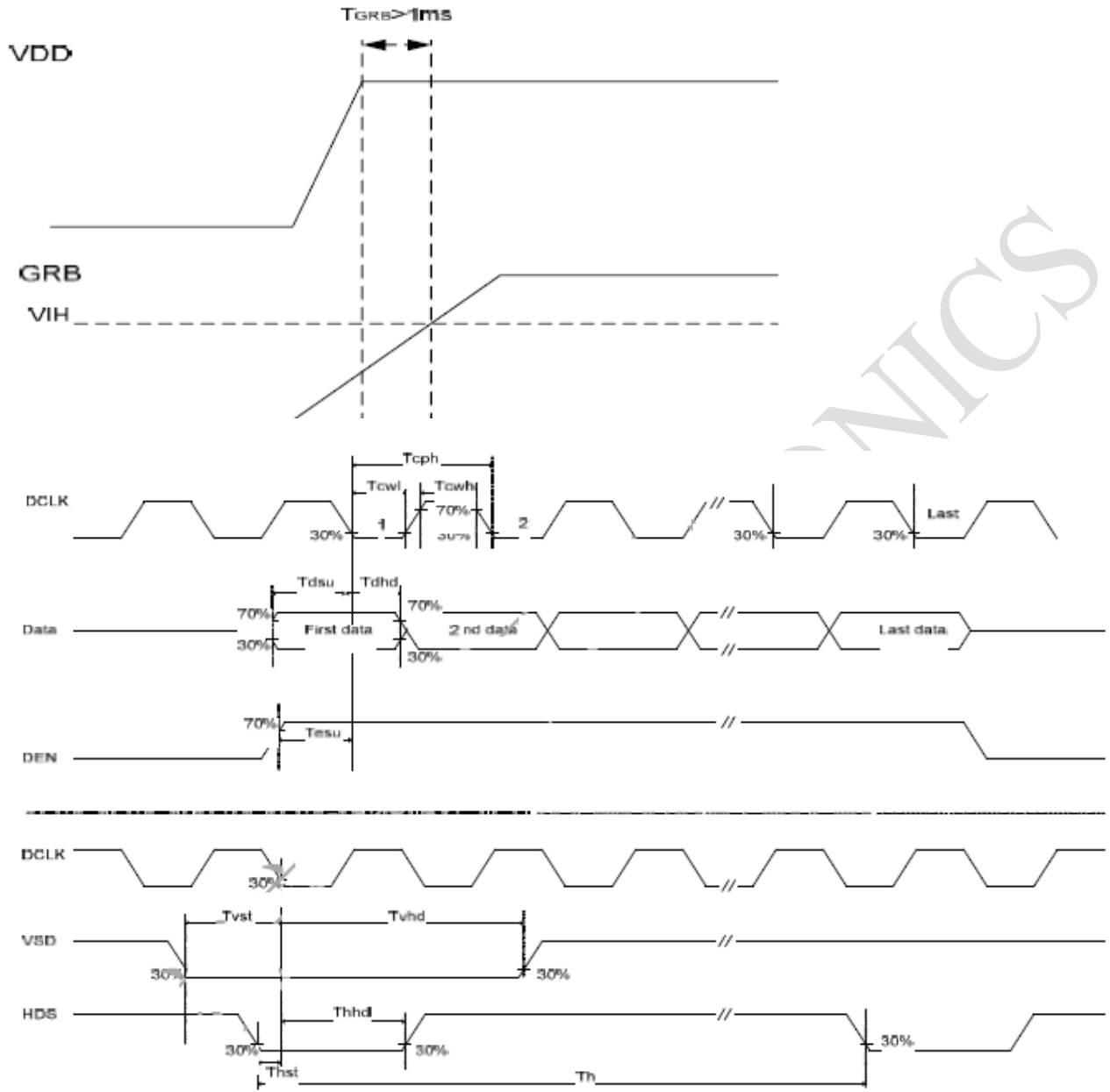

Parallel Input Clock and Data timing

8.3. LVDS DC Characteristics

Parameter	Symbol	Min.	Typ.	Max.	Unit	Remark
Differential input high Threshold voltage	RxVTH	-	-	+0.1		
Differential input low Threshold voltage	RxVTL	-0.1	-	-	V	
Input voltage range (singled-end)	RxVIN	0	-	2.4	V	
Differential input common mode voltage	RxVCM	VID /2	-	2.4- VID /2	V	
Differential input voltage	VID	0.2	-	0.6	V	
Differential input leakage current	RVxliz	-10	-	+10	uA	
LVDS Digital operating Current	Iddlvsd	-	40(TBD)	50	mA	Fclk=65Mhz VDD=3.3V
LVDS Digital Standby Current	Istlvds	--	10(TBD)	50	uA	Clock & all Functions are

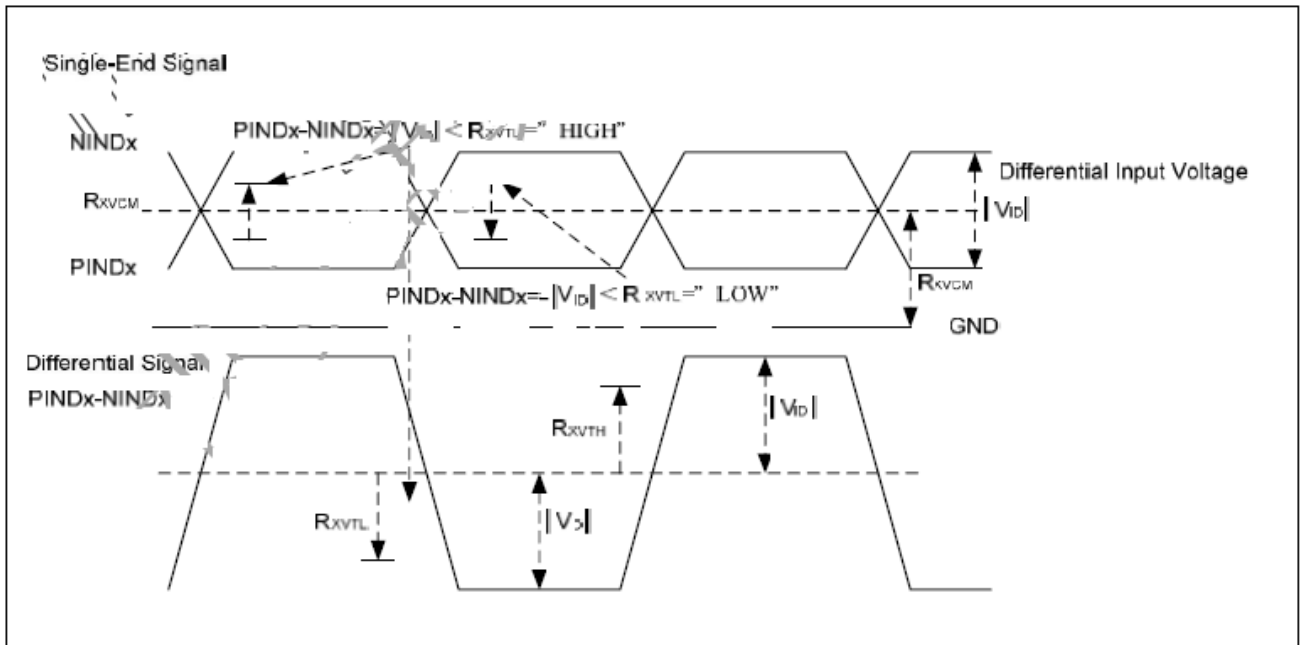

LVDS DC Characteristics

HV mode(1)

HV mode

Horizontal input timing

Parameter		Symbol	Value			Unit
Horizontal display area		thn	1024			DCLK
DCLK frequency @ Frame rate=60hz		fclk	Min.	Typ.	Max.	Mhz
			44.9	51.2	63	
1 Horizontal Line		Th	1200	1344	1400	DCLK
HSYNC pulse width	Min.	thpw	1			
	Typ.		-			
	Max.		140			
HSYNC back porch		thbp	160	160	160	
HSYNC front porch		thfp	16	160	216	

HV mode(2)

Parameter	Symbol	Value			Unit
		Min.	Typ.	Max.	
Vertical display area	tvd	600			H
VSYNC period time	tv	624	635	750	H
VSYNC pulse width	tvpw	1	-	20	H
VSYNC back porch	tvb	23	23	23	H
VSYNC front porch	tvfp	1	12	127	H

Data Input Format
6bit LVDS input(HSD="H")

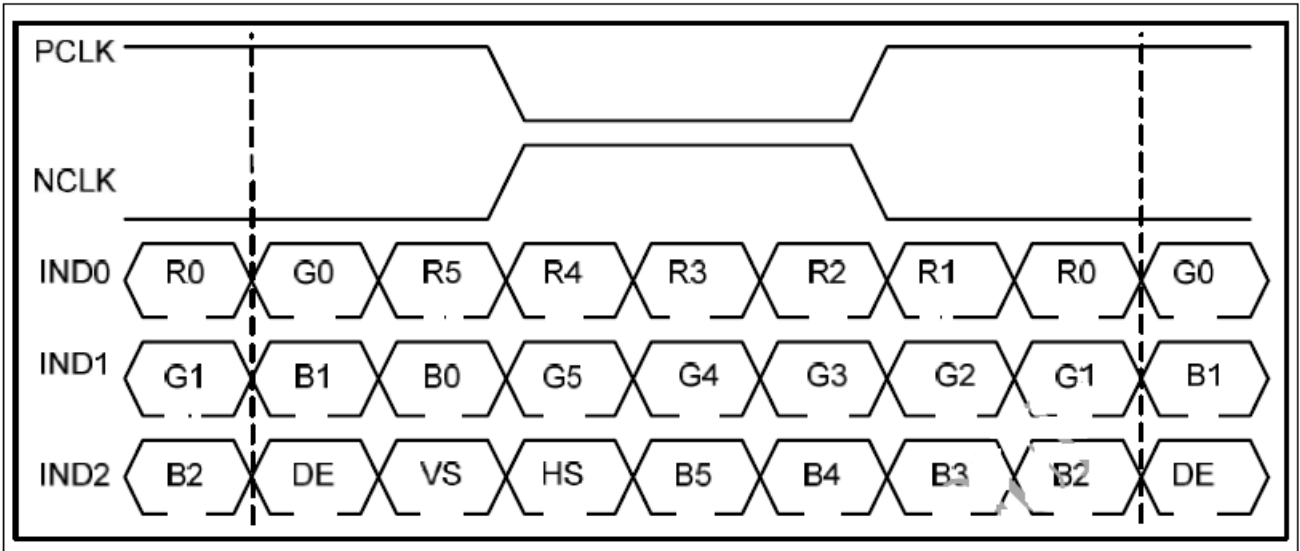

6-bit LVDS input timing chart

8bit LVDS input(HSD="L")

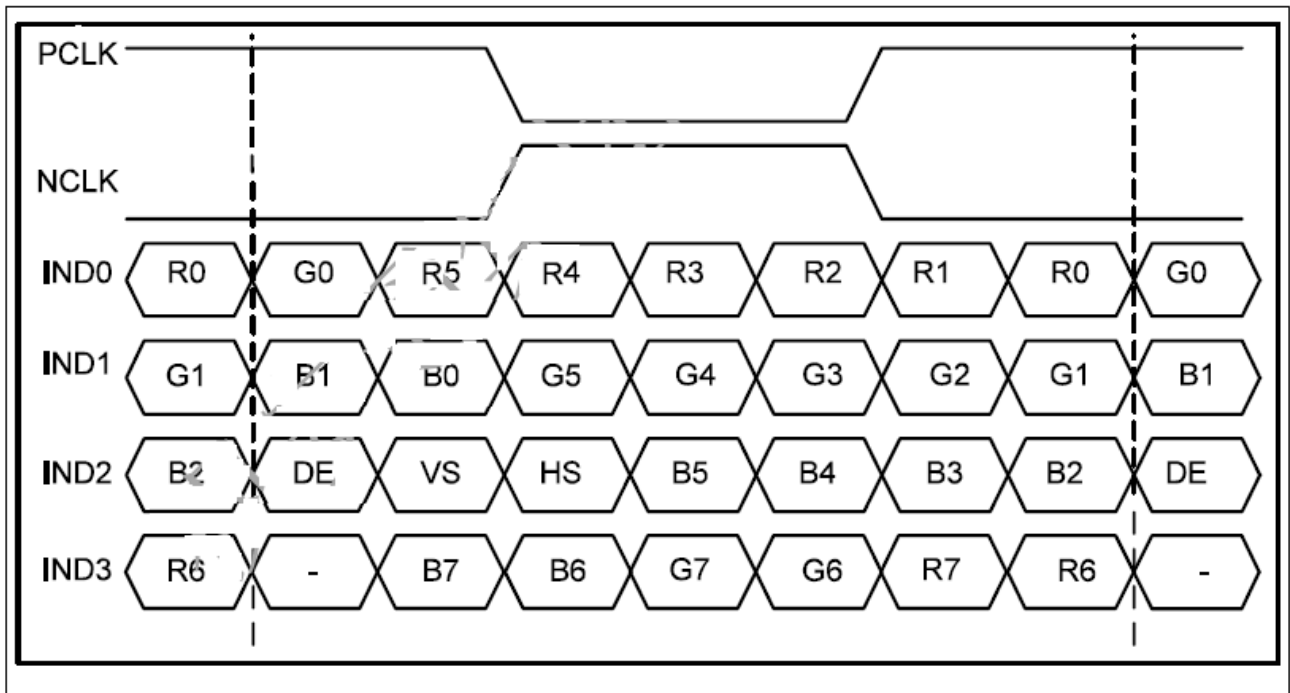

8-bit LVDS input timing chart

9. Optical Characteristics

Item	Symbol	Condition.	Min	Typ.	Max.	Unit	Remark	
Response time	Tr	$\theta=0^\circ$ 、 $\Phi=0^\circ$	-	25	40	.ms	Note 3	
	Tf							
Contrast ratio	CR	At optimized viewing angle	600	800	-	-	Note 4	
Color Chromaticity	White	$\theta=0^\circ$ 、 $\Phi=0$	0.26	0.31	0.36	-	Note 2,5,6	
								Wy
Viewing angle (Gray Scale Inversion Direction)	Hor.	$CR \geq 10$	70	80	-	Deg.	Note 1	
								θ_L
	Ver.							Φ_T
								Φ_B
Brightness	-	-	500	600	-	cd/m ²	Center of display	
Uniformity	(U)	-	70	-	-	%	Note 5	

Ta=25±2℃,

Note 1: Definition of viewing angle range

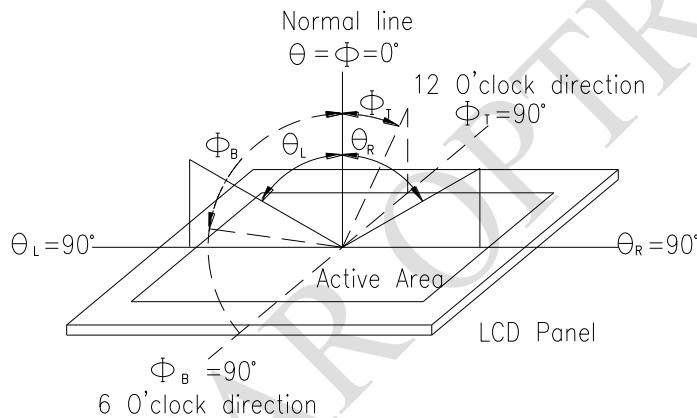

Fig. 9.1. Definition of viewing angle

Note 2: Test equipment setup:

After stabilizing and leaving the panel alone at a driven temperature for 10 minutes, the measurement should be executed. Measurement should be executed in a stable, windless, and dark room. Optical specifications are measured by Topcon BM-7 or BM-5 luminance meter 1.0° field of view at a distance of 50cm and normal direction.

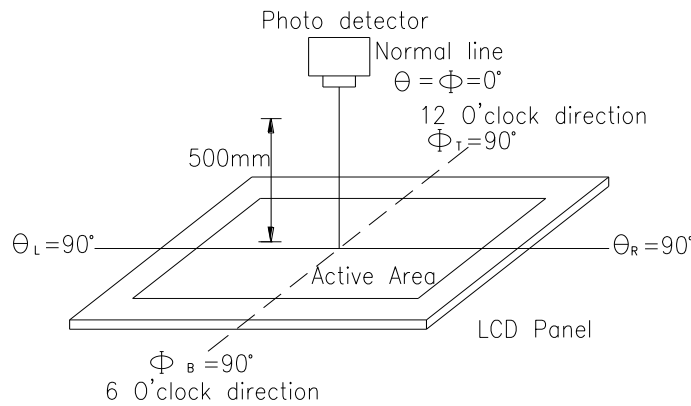
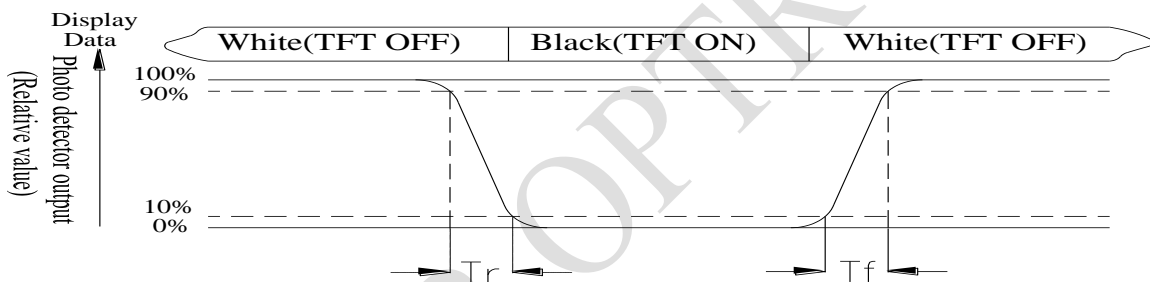

Fig. 9.2. Optical measurement system setup

Note 3: Definition of Response time:

The response time is defined as the LCD optical switching time interval between “White” state and “Black” state. Rise time, T_r , is the time between photo detector output intensity changed from 90% to 10%. And fall time, T_f , is the time between photo detector output intensity changed from 10% to 90%



Note 4: Definition of contrast ratio:

The contrast ratio is defined as the following expression.

$$\text{Contrast ratio (CR)} = \frac{\text{Luminance measured when LCD on the "White" state}}{\text{Luminance measured when LCD on the "Black" state}}$$

Note 5: Definition of Luminance Uniformity

Active area is divided into 9 measuring areas (reference the picture in below). Every measuring point is placed at the center of each measuring area.

Luminance Uniformity (U) = $L_{min}/L_{max} \times 100\%$

L = Active area length

W = Active area width

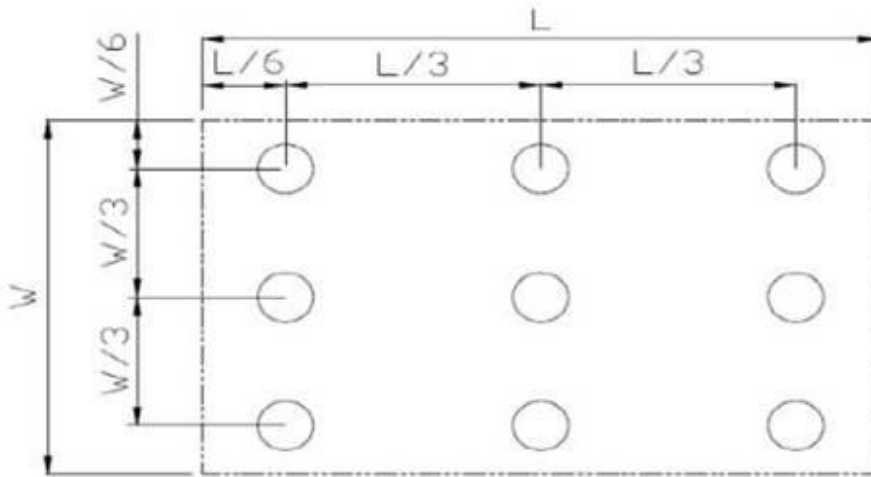

Fig9.3. Definition of uniformity

Note 6: Definition of color chromaticity (CIE 1931)

Color coordinates measured at the center point of LCD

Note 7: Measured at the center area of the panel when all the input terminals of LCD panel are electrically opened.

10. Reliability

Content of Reliability Test (Wide temperature, -20°C ~70°C)

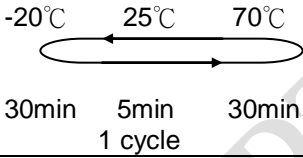
Environmental Test			
Test Item	Content of Test	Test Condition	Note
High Temperature storage	Endurance test applying the high storage temperature for a long time.	80°C 200hrs	2
Low Temperature storage	Endurance test applying the low storage temperature for a long time.	-30°C 200hrs	1,2
High Temperature Operation	Endurance test applying the electric stress (Voltage & Current) and the thermal stress to the element for a long time.	70°C 200hrs	—
Low Temperature Operation	Endurance test applying the electric stress under low temperature for a long time.	-20°C 200hrs	1
High Temperature/ Humidity Operation	The module should be allowed to stand at 60°C, 90%RH max	60°C, 90%RH 96hrs	1,2
Thermal shock resistance	The sample should be allowed stand the following 10 cycles of operation <div style="text-align: center;">  <p>-20°C 25°C 70°C</p> <p>30min 5min 30min</p> <p>1 cycle</p> </div>	-20°C/70°C 10 cycles	—
Vibration test	Endurance test applying the vibration during transportation and using.	Total fixed amplitude : 1.5mm Vibration Frequency : 10~55Hz One cycle 60 seconds to 3 directions of X,Y,Z for Each 15 minutes	3
Static electricity test	Endurance test applying the electric stress to the terminal.	VS=±600V(contact) ,±800v(air), RS=330Ω CS=150pF 10 times	—

Note1: No dew condensation to be observed.

Note2: The function test shall be conducted after 4 hours storage at the normal Temperature and humidity after remove from the test chamber.

Note3: The packing have to including into the vibration testing.

LCM Sample Estimate Feedback Sheet

Module Number : _____

1 、 Panel Specification :

1. Panel Type :	<input type="checkbox"/> Pass	<input type="checkbox"/> NG , _____
2. View Direction :	<input type="checkbox"/> Pass	<input type="checkbox"/> NG , _____
3. Numbers of Dots :	<input type="checkbox"/> Pass	<input type="checkbox"/> NG , _____
4. View Area :	<input type="checkbox"/> Pass	<input type="checkbox"/> NG , _____
5. Active Area :	<input type="checkbox"/> Pass	<input type="checkbox"/> NG , _____
6. Operating Temperature :	<input type="checkbox"/> Pass	<input type="checkbox"/> NG , _____
7. Storage Temperature :	<input type="checkbox"/> Pass	<input type="checkbox"/> NG , _____
8. Others :	_____	

2 、 Mechanical Specification :

1. PCB Size :	<input type="checkbox"/> Pass	<input type="checkbox"/> NG , _____
2. Frame Size :	<input type="checkbox"/> Pass	<input type="checkbox"/> NG , _____
3. Material of Frame :	<input type="checkbox"/> Pass	<input type="checkbox"/> NG , _____
4. Connector Position :	<input type="checkbox"/> Pass	<input type="checkbox"/> NG , _____
5. Fix Hole Position :	<input type="checkbox"/> Pass	<input type="checkbox"/> NG , _____
6. Backlight Position :	<input type="checkbox"/> Pass	<input type="checkbox"/> NG , _____
7. Thickness of PCB :	<input type="checkbox"/> Pass	<input type="checkbox"/> NG , _____
8. Height of Frame to PCB :	<input type="checkbox"/> Pass	<input type="checkbox"/> NG , _____
9. Height of Module :	<input type="checkbox"/> Pass	<input type="checkbox"/> NG , _____
10. Others :	<input type="checkbox"/> Pass	<input type="checkbox"/> NG , _____

3 、 Relative Hole Size :

1. Pitch of Connector :	<input type="checkbox"/> Pass	<input type="checkbox"/> NG , _____
2. Hole size of Connector :	<input type="checkbox"/> Pass	<input type="checkbox"/> NG , _____
3. Mounting Hole size :	<input type="checkbox"/> Pass	<input type="checkbox"/> NG , _____
4. Mounting Hole Type :	<input type="checkbox"/> Pass	<input type="checkbox"/> NG , _____
5. Others :	<input type="checkbox"/> Pass	<input type="checkbox"/> NG , _____

4 、 Backlight Specification :

1. B/L Type :	<input type="checkbox"/> Pass	<input type="checkbox"/> NG , _____
2. B/L Color :	<input type="checkbox"/> Pass	<input type="checkbox"/> NG , _____
3. B/L Driving Voltage (Reference for LED Type) :	<input type="checkbox"/> Pass	<input type="checkbox"/> NG , _____
4. B/L Driving Current :	<input type="checkbox"/> Pass	<input type="checkbox"/> NG , _____
5. Brightness of B/L :	<input type="checkbox"/> Pass	<input type="checkbox"/> NG , _____
6. B/L Solder Method :	<input type="checkbox"/> Pass	<input type="checkbox"/> NG , _____
7. Others :	<input type="checkbox"/> Pass	<input type="checkbox"/> NG , _____

>> **Go to page 2** <<

Module Number : _____

5 · Electronic Characteristics of Module :

1.Input Voltage :	<input type="checkbox"/> Pass	<input type="checkbox"/> NG , _____
2.Supply Current :	<input type="checkbox"/> Pass	<input type="checkbox"/> NG , _____
3.Driving Voltage for LCD :	<input type="checkbox"/> Pass	<input type="checkbox"/> NG , _____
4.Contrast for LCD :	<input type="checkbox"/> Pass	<input type="checkbox"/> NG , _____
5.B/L Driving Method :	<input type="checkbox"/> Pass	<input type="checkbox"/> NG , _____
6.Negative Voltage Output :	<input type="checkbox"/> Pass	<input type="checkbox"/> NG , _____
7.Interface Function :	<input type="checkbox"/> Pass	<input type="checkbox"/> NG , _____
8.LCD Uniformity :	<input type="checkbox"/> Pass	<input type="checkbox"/> NG , _____
9.ESD test :	<input type="checkbox"/> Pass	<input type="checkbox"/> NG , _____
10.Others :	<input type="checkbox"/> Pass	<input type="checkbox"/> NG , _____

6 · Summary :
Sales signature : _____

Customer Signature : _____

Date : / / _____

X-ON Electronics

Largest Supplier of Electrical and Electronic Components

Click to view similar products for [TFT Displays & Accessories](#) category:

Click to view products by [Raystar](#) manufacturer:

Other Similar products are found below :

[OAI-80038AA-2013-A](#) [HDA430T-3G1H](#) [EA CARREDIPTFT02](#) [NL6448BC20-21D](#) [NB7W-KBA04](#) [NB-ATT01](#) [NB5Q-ATT01](#) [NB5Q-KBA04](#) [NB-CN001](#) [NL12880BC20-05](#) [NL8060BC26-35C](#) [NL8060BC26-35F](#) [TCG104SVLQAPNN-AN20](#) [OAI-80038AA-2008-A](#) [315-U004B15300](#) [UMSH-8596MD-34T \(REV D\)](#) [98-0003-3490-8](#) [1044278](#) [1029309](#) [1060549](#) [DE 127-TU-30/7,5](#) [DE 128-TU-20/7,5](#) [EP-LK007TFTPCAP](#) [FR7.0A00](#) [RC2002A-TIG-CSX](#) [NL6448BC2021C](#) [TX17D01VM2EAB](#) [TX14D23VM5BAA](#)
[TCG121WXLRXVNNANX35](#) [EIC-LCD-1080P](#) [T272480C07VR01](#) [1060632](#) [TCG070WVLPAAANN-AN50](#) [TCG035QVLPDANN-GN50](#)
[1060630](#) [RFE430V-AIW-DNG](#) [T-55619GD065J-LW-ABN](#) [NHD-1.8-128160EF-SSXN-FT](#) [TCG104SVLPEANN-AN30](#) [NL6448BC33-70](#)
[NL192108BC18-06F](#) [NLB150XG02L-01](#) [NL6448BC20-30D](#) [NL10276BC16-06](#) [NL192108AC10-01D](#) [NL6448AC18-08F](#) [NL6448BC20-30F](#)
[NL12880BC20-05BD](#) [NL12880BC20-05D](#) [NL8060BC26-35BA](#)