



RAYSTAR

RAYSTAR Optronics, Inc.
曜凌光電股份有限公司



曜凌光電股份有限公司 Raystar Optronics, Inc.

42881台中市大雅區科雅路25號5樓
5F, No. 25, Keya Road, Daya Dist., Taichung City 42881, Taiwan
T : +886-4-2565-0761 | F : +886-4-2565-0760
sales@raystar-optronics.com | www.raystar-optronics.com

RFK1010L-AYH-LNN

SPECIFICATION

CUSTOMER:

APPROVED BY	
PCB VERSION	
DATE	

FOR CUSTOMER USE ONLY

SALES BY	APPROVED BY	CHECKED BY	PREPARED BY

Release DATE:

TFT Display Inspection Specification: <https://www.raystar-optronics.com/download/products.htm>
Precaution in use of TFT module: <https://www.raystar-optronics.com/download/declaration.htm>

Revision History

VERSION	DATE	REVISED PAGE NO.	Note
0	2021/11/12		First issue
A	2021/11/18		Modify Contour Drawing
B	2021/12/09		Add Backlight Driving Part
			Modify General Specifications & Current Consumption
C	2022/01/29		Modify CN

Contents

1. Module Classification Information
2. Summary
3. General Specifications
4. Interface
5. Contour Drawing
6. Absolute Maximum Ratings
7. Electrical Characteristics
8. AC Characteristics
9. LVDS Input Timing Table
10. Power Sequence
11. Optical Characteristics
12. Reliability
13. Other

1. Module Classification Information

R	F	K	101	0L	-	A	Y	H	-	L	N	N
1	2	3	4	5	-	6	7	8	-	9	10	11

Item	Description	
1	R : Raystar Optronics Inc.	
2	Display Type : F→TFT Type, J→ Custom TFT	
3	Solution: A: 128x160 B:320x234 C:320x240 D:480x234 E:480x272 F:800x480 G:640x480 H:1024x600 I:320x480 J:240x320 K:1280x800 L:240x400 M:1024x768 N:128x128 O:480x800 P:640x320 Q:800x600 S:480x128 T:800x320	
4	Display Size : 10.1" TFT	
5	Version Code.	
6	Model Type: A : TFT LCD E : TFT+FR+CONTROL BOARD J : TFT+FR+A/D BOARD N : TFT+FR+A/D BOARD+CONTROL BOARD S : TFT+FR+POWER BOARD (DC TO DC) 1 : TFT+CONTROL BOARD	6 : TFT+FR H : TFT+D/V BOARD I : TFT+FR+D/V BOARD B : TFT+POWER BD
7	Polarizer Type, Temperature range, View direction	I→Transmissive, W. T, 6:00 ; C→Transmissive, N. T, 6:00 L→Transmissive, W.T,12:00 ; F→Transmissive, N.T,12:00 Y→Transmissive,W.T, IPS TFT ; A→Transmissive, N.T, IPS TFT Z→Transmissive, W.T, O-TFT R→Transmissive, Super W.T, O-TFT N→Transmissive, Super W.T, 6:00; Q→Transmissive, Super W.T, 12:00 V→Transmissive, Super W.T, VA TFT
8	Backlight	W : LED, White H : LED, High Light White F : CCFL, White
9	Driver Method	D: Digital A: Analog L : LVDS M:MIPI
10	Interface	N : without control board A : 8Bit B : 16Bit S:SPI Interface R: RS232 U:USB I: I2C
11	TS	N : Without TS S : resistive touch panel C : capacitive touch panel capacitive touch panel (G-F-F) G : capacitive touch panel(G-G)

2.Summary

TFT 10.1" is a color active matrix thin film transistor (TFT) liquid crystal display (LCD) that uses amorphous silicon TFT as a switching device. This model is composed of a TFT LCD panel, a driving circuit and a back light system. This TFT LCD has a 10.1 inch diagonally measured active display area with HD (1280 horizontal by 800 vertical pixel) resolution.

RAYSTAR OPTRONICS

3.General Specifications

- Screen Diagonal: 10.1 inch
- Number of Pixels: 1280 x 3(R GB) x 800 dots
- Module dimension: 230.56 x 155.01 x 6.4 mm
- Active area: 216.96 (H) x 135.6(V) mm
- Pixel pitch: 0.1695 × 0.1695 mm
- Display Mode: Normally Black , Transmissive
- Viewing Angle: 80/80/80/80
- Pixel Arrangement: R.G.B. Vertical Stripe
- TFT Drive IC: EK79202B1 or Equivalent
- Backlight Type: LED, Normally White
- Aspect Ratio: 16:10
- TFT Interface: LVDS
- With /Without TP: Without TP
- Surface: Anti-Glare

*Color tone slight changed by temperature and driving voltage.

4.Interface

4.1. Interface Connector

A 40pin connector is used for the module electronics interface. The recommended model is F62240-H1210B manufactured by Vigorconn.

Pin No.	Symbol	I/O	Function	Remark
1	NC	-	No connection	
2	VCC	P	Power Supply	
3	VCC	P	Power Supply	
4	NC	-	No connection	
5	NC	-	No connection	
6	NC	-	No connection	
7	GND	P	Ground	
8	Rxin0-	I	-LVDS Differential Data Input	R0-R5,G0
9	Rxin0+	I	+LVDS Differential Data Input	
10	GND	P	Ground	
11	Rxin1-	I	-LVDS Differential Data Input	G1G5,B0,B1
12	Rxin1+	I	+LVDS Differential Data Input	
13	GND	P	Ground	
14	Rxin2-	I	-LVDS Differential Data Input	B2-B5,HS,VS, DE
15	Rxin2+	I	+LVDS Differential Data Input	
16	GND	P	Ground	
17	RxCLK-	I	-LVDS Differential Clock Input	LVDS CLK
18	RxCLK+	I	+LVDS Differential Clock Input	
19	GND	P	Ground	
20	Rxin3-	I	-LVDS Differential Data Input	R6,R7,G6,G7, B6,B7
21	Rxin3+	I	+LVDS Differential Data Input	
22	GND	P	Ground	
23	NC	-	No connection	
24	NC	-	No connection	
25	GND	P	Ground	
26	NC	-	No connection	
27	NC	-	No connection	
28	NC	-	No connection	
29	NC	-	No connection	

30	GND	P	Ground	
31	NC	-	No connection	
32	NC	-	No connection	
33	NC	-	No connection	
34	NC	-	No connection	
35	VGL	P	Gate OFF Voltage	
36	NC	-	No connection	
37	NC	-	No connection	
38	VGH	P	Gate ON Voltage	
39	NC	-	No connection	
40	NC	-	No connection	

I: input, O: output, P: Power

4.2. Backlight Driving Part

Pin No.	Symbol	Function
1	LED+	Red, LED_ Anode
2	LED-	Black, LED_ Cathode

Note: The backlight interface connector is a model BHSR-02VS-01 or equivalent.

5. Contour Drawing

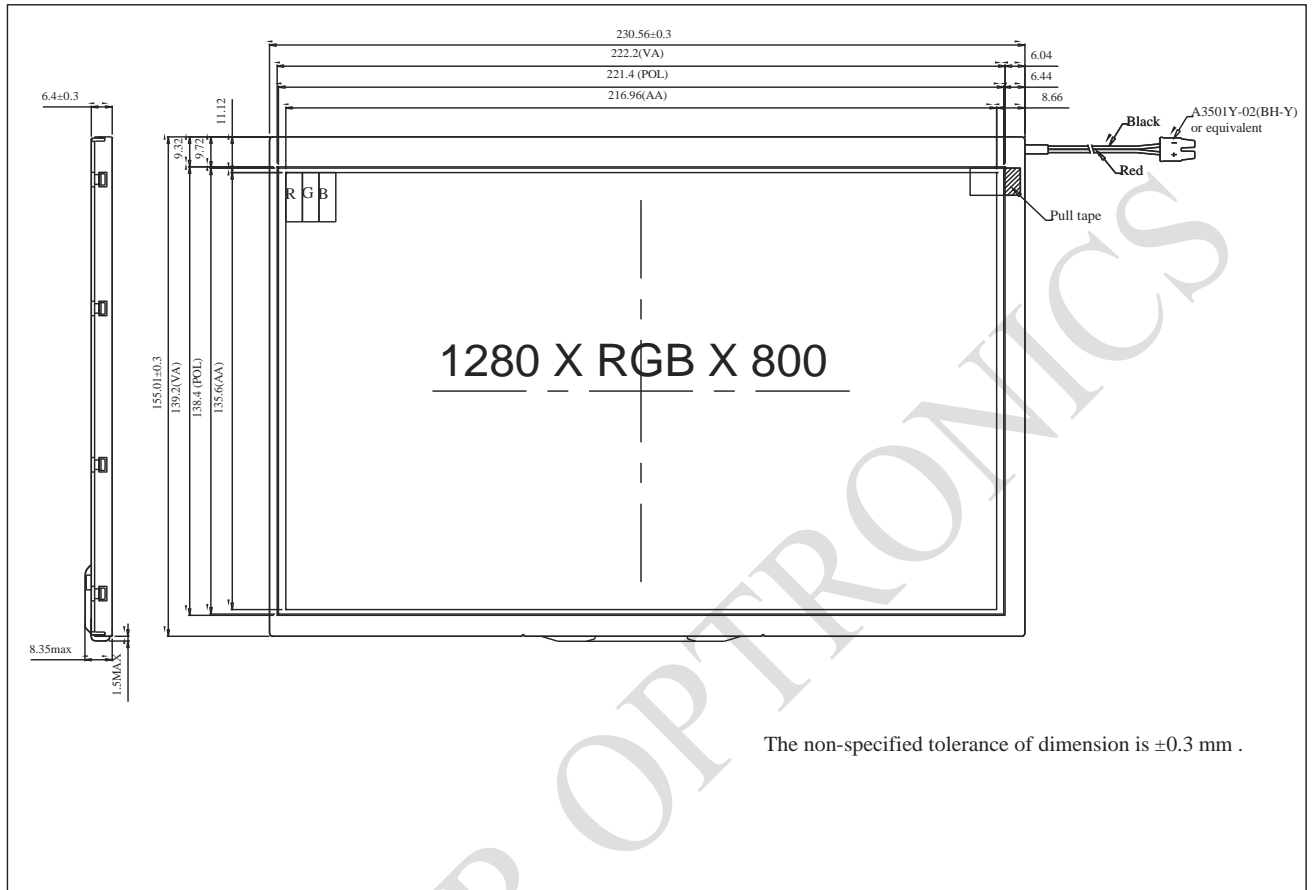

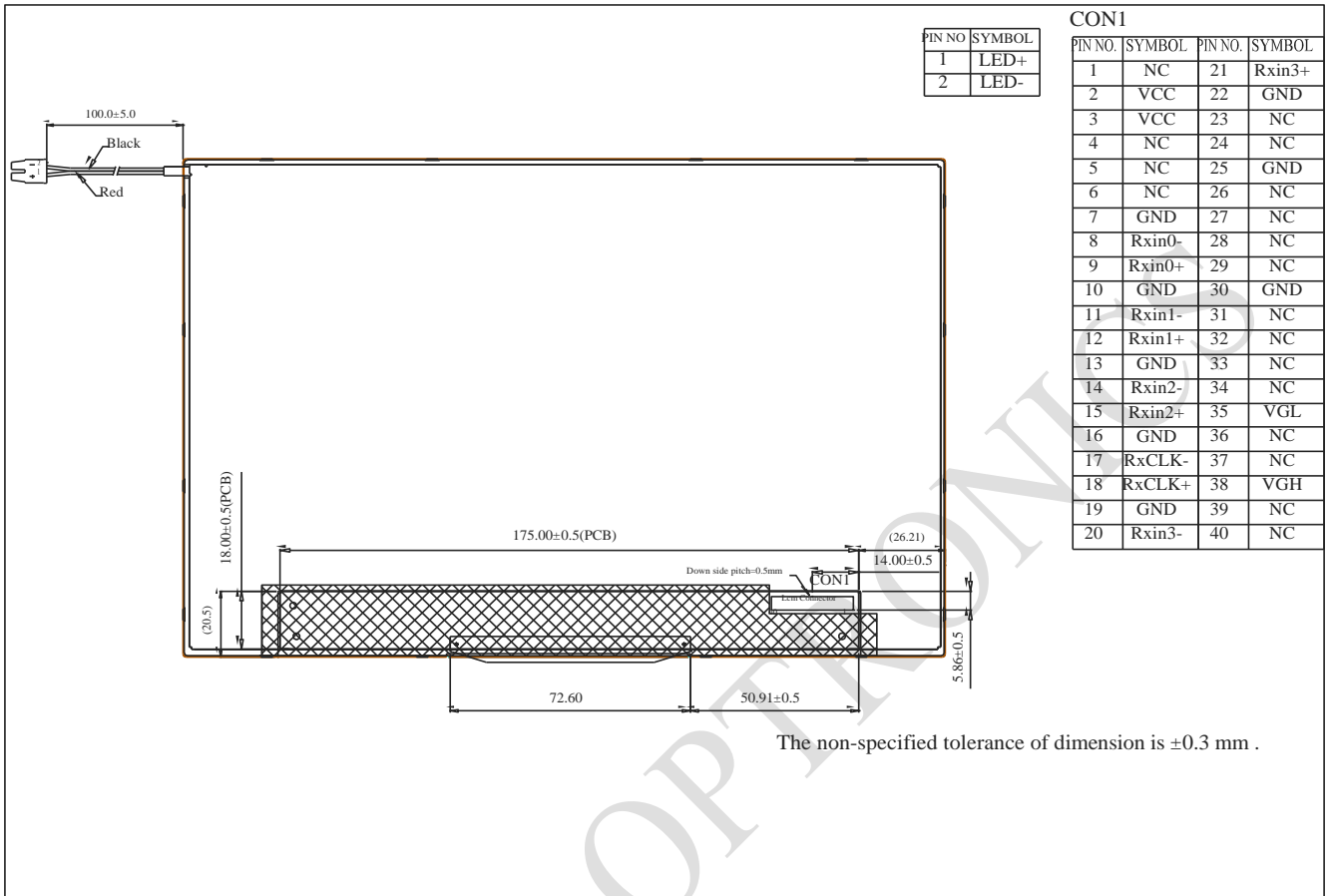

6. Absolute Maximum Ratings

Item	Symbol	Min	Typ	Max	Unit
Operating Temperature	TOP	-20	—	+70	□
Storage Temperature	TST	-30	—	+80	□

Note: Device is subject to be damaged permanently if stresses beyond those absolute maximum ratings listed above

- Temp. □60□, 90% RH MAX. Temp. > 60□, Absolute humidity shall be less than 90% RH at 60□

RAYSTAR OPTRONICS

7. Electrical Characteristics

7.1. Typical Operation Conditions (Note 1)

Item	Symbol	Values			Unit	Remark
		Min.	Typ.	MAX.		
Power voltage	VCC	3.0	3.3	3.5	V	
	VGH		18		V	Note 1
	VGL		-10		V	Note 2
	VSP		5.5		V	Note 3
	VSN		-5.5		V	Note 3

Note:

1. VGH is TFT Gate operating Voltage.
2. VGL is TFT Gate operating Voltage.
3. VSP / VSN does not require an external power supply voltage, it is provided by IC on the PCB

7.2. Current Consumption

Item	Symbol	Values			Unit	Remark
		Min.	Typ.	MAX.		
Current for Driver	IGH	—	7.7	—	mA	VGH =18V
	IGL	—	7.7	—	mA	VGL = -10V
	IVCC	—	85	130	mA	—

7.3. Backlight Characteristics

Parameter	Symbol	Min.	Typ.	Max.	Unit	Remark
Supply voltage of white LED backlight	VL	10.8	12.8	13.6	V	Note 1
Current for LED backlight	IL	—	480	—	mA	
LED life time	-	50000	-	-	Hr	Note 1

Note 1 : There are 1 Groups LED

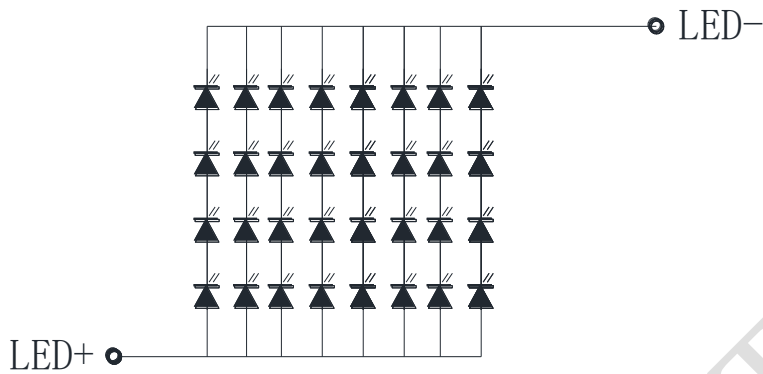

Note 2 : $T_a = 25\text{ }^\circ\text{C}$

Note 3 : Brightness to be decreased to 50% of the initial value

Note 4 : The single LED lamp case

8.AC Characteristics

8.1. LVDS mode AC electrical characteristics

Parameter	Symbol	Spec.			Unit	Condition
		Min.	Typ.	Max.		
Clock frequency	R_{xFCLK}	30	-	TBD	MHz	Refer to input timing table for each display resolution
Input data skew margin	T_{RSKM}	500	┆	-	ps	$ VID = 200mV$ $RxVCM = 1.2V$ $RxFCLK = 81MHz$
Clock high time	T_{LVCH}	-	$4/(7 * R_{xFCLK})$	-	ns	
Clock low time	T_{LVCL}	-	$3/(7 * R_{xFCLK})$	-	ns	
PLL wake-up time	T_{enPLL}	-	-	150	us	

Table 1: LVDS mode AC electrical characteristics

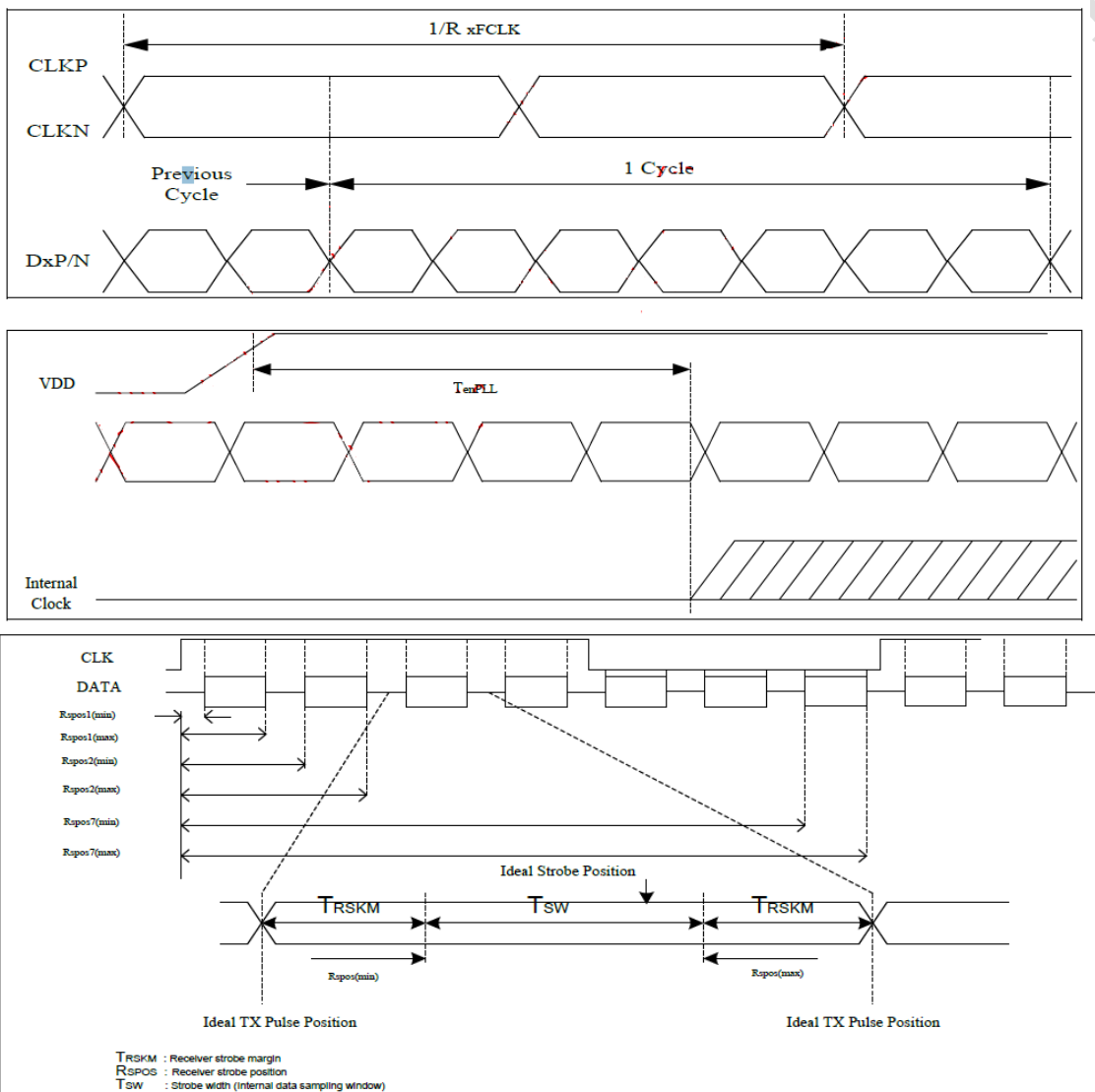
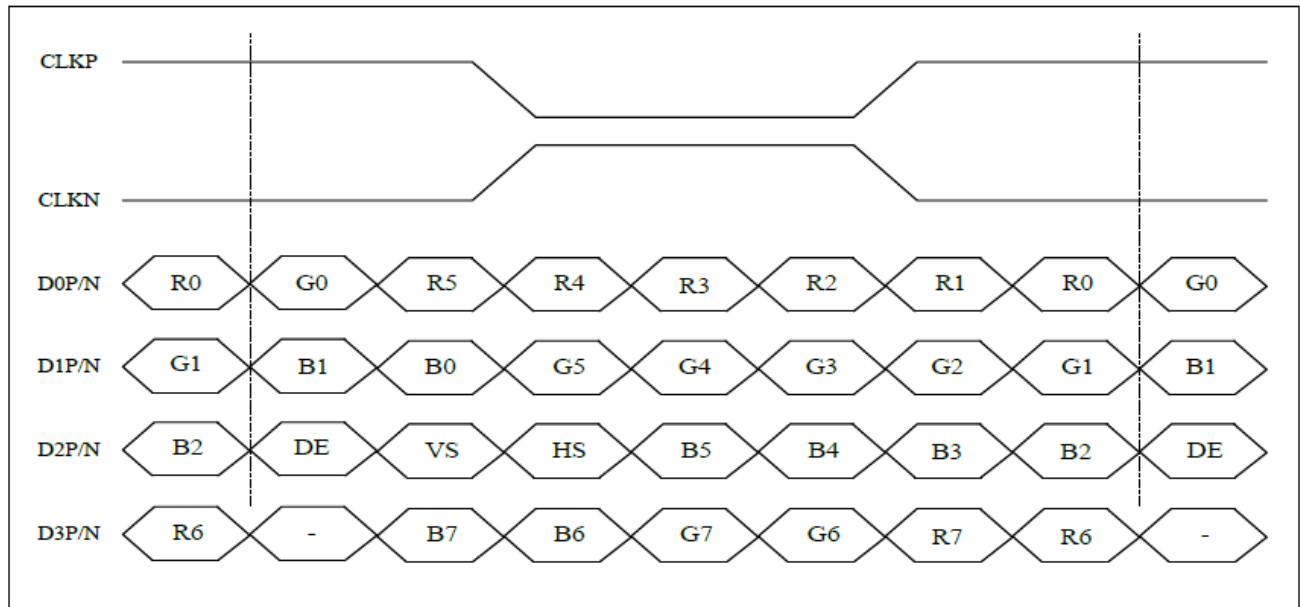

Figure 1: LVDS figure

9.LVDS Input Timing Table

For 1280RGBx800 timing table

Parameter	Symbol	Value			Unit
		Min.	Typ.	Max.	
DCLK frequency @Frame rate=60Hz (LVDS)	F_{DCLK}	69.7	75	80.9	MHz
Horizontal display area	T_{HD}	1280			DCLK
HSYNC period time	T_H	1380	1440	1500	DCLK
HSYNC blanking	$T_{HBP}+T_{HFP}$	100	160	220	DCLK
Vertical display area	T_{VD}	800			H
VSYNC period time	T_V	842	838	872	H
VSYNC blanking	$T_{VBP}+T_{VFP}$	24	38	72	H



8-bit LVDS input

Vertical timing

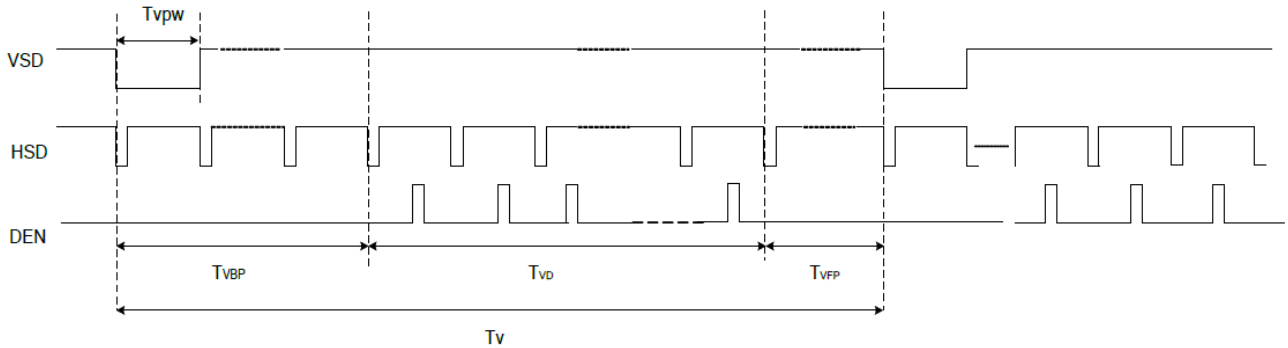

Horizontal timing

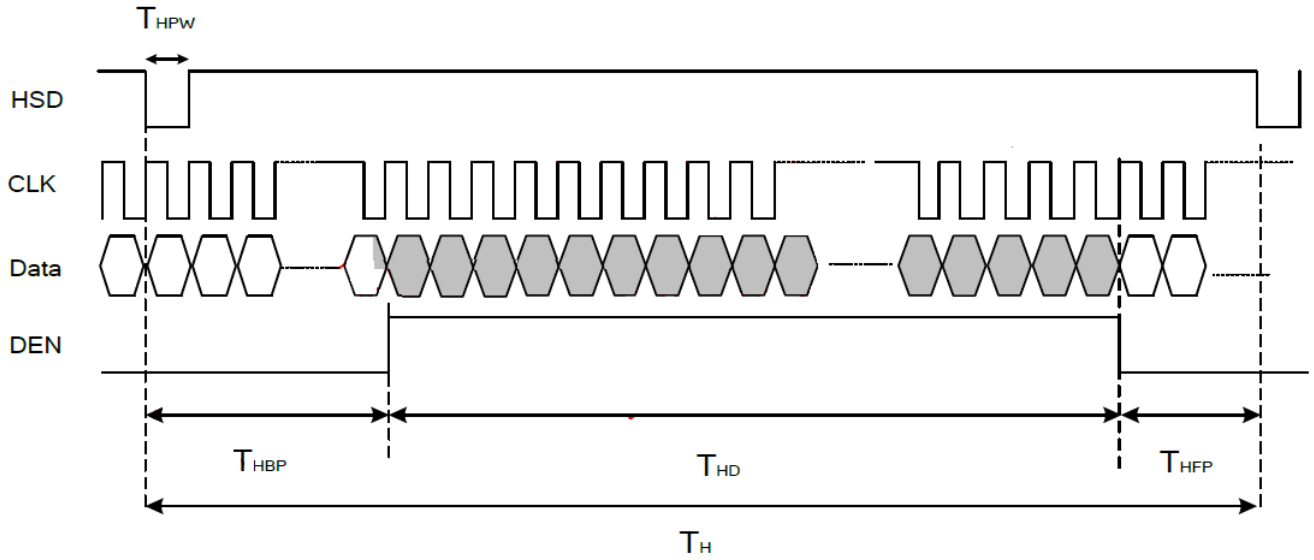

RAYSTAR

10. Power Sequence

10.1. Power Generation

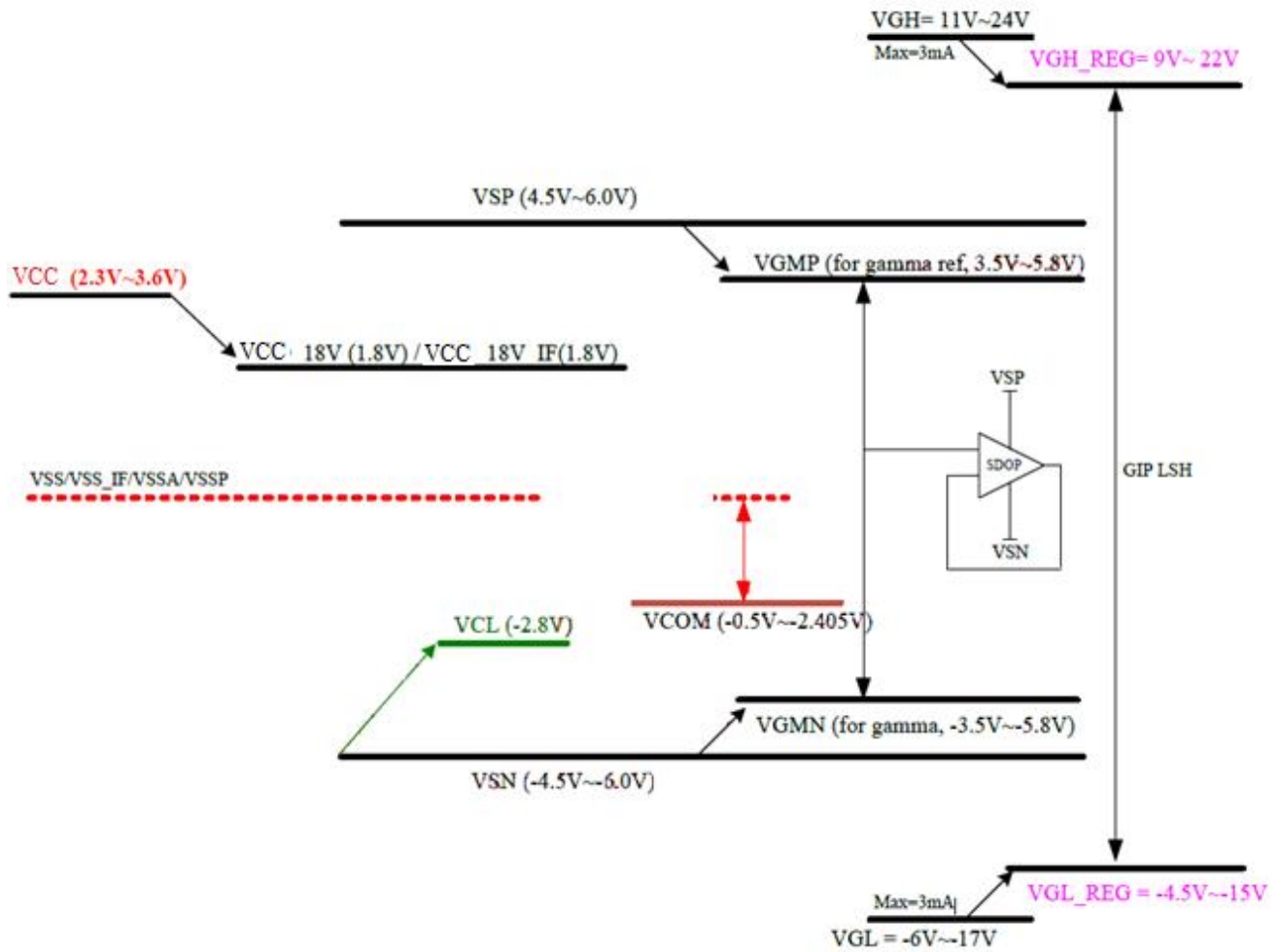
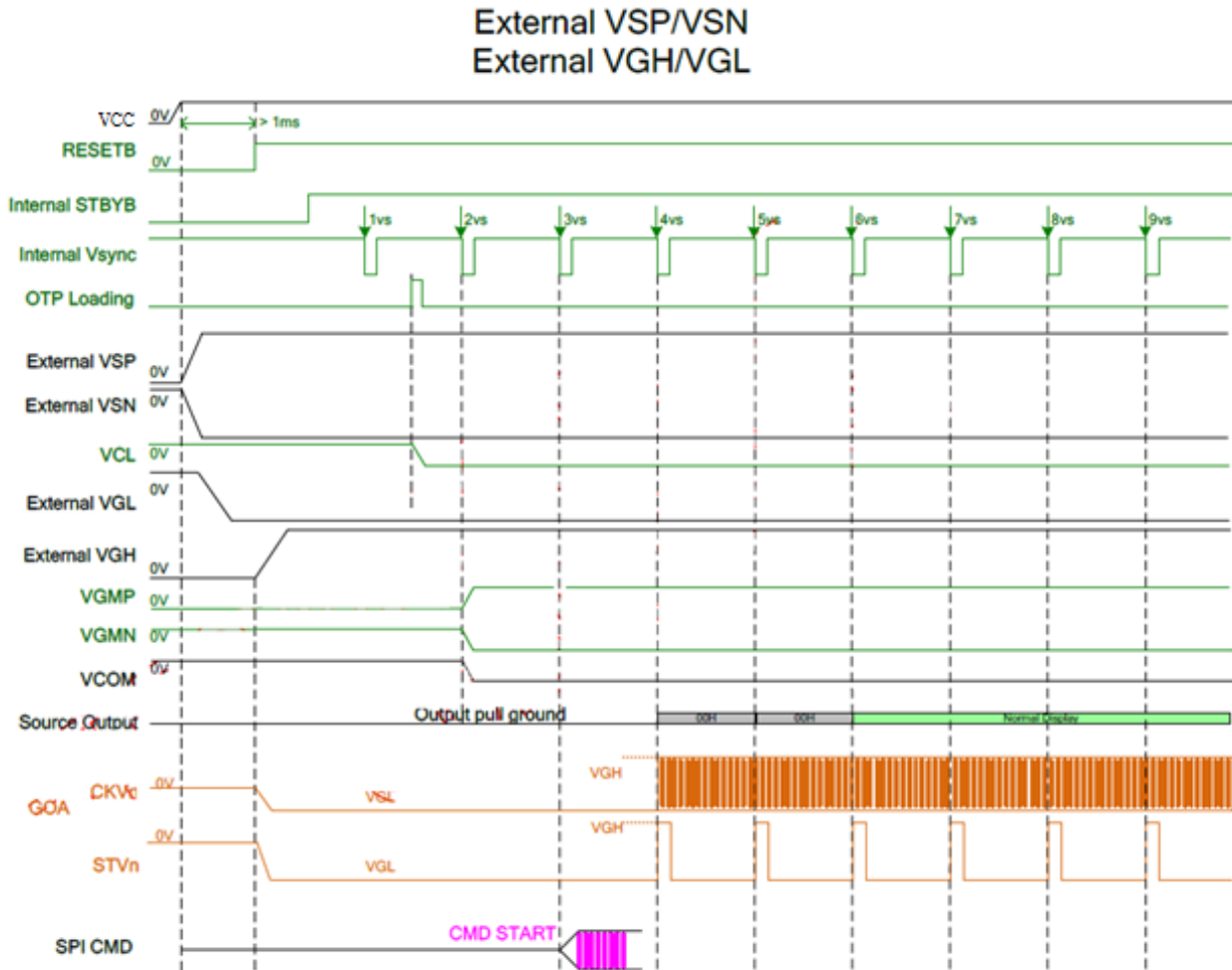

Figure 1 power generation

RAYSTAR

10.2. Power on sequence



RAYSTAR

10.3. Power off sequence

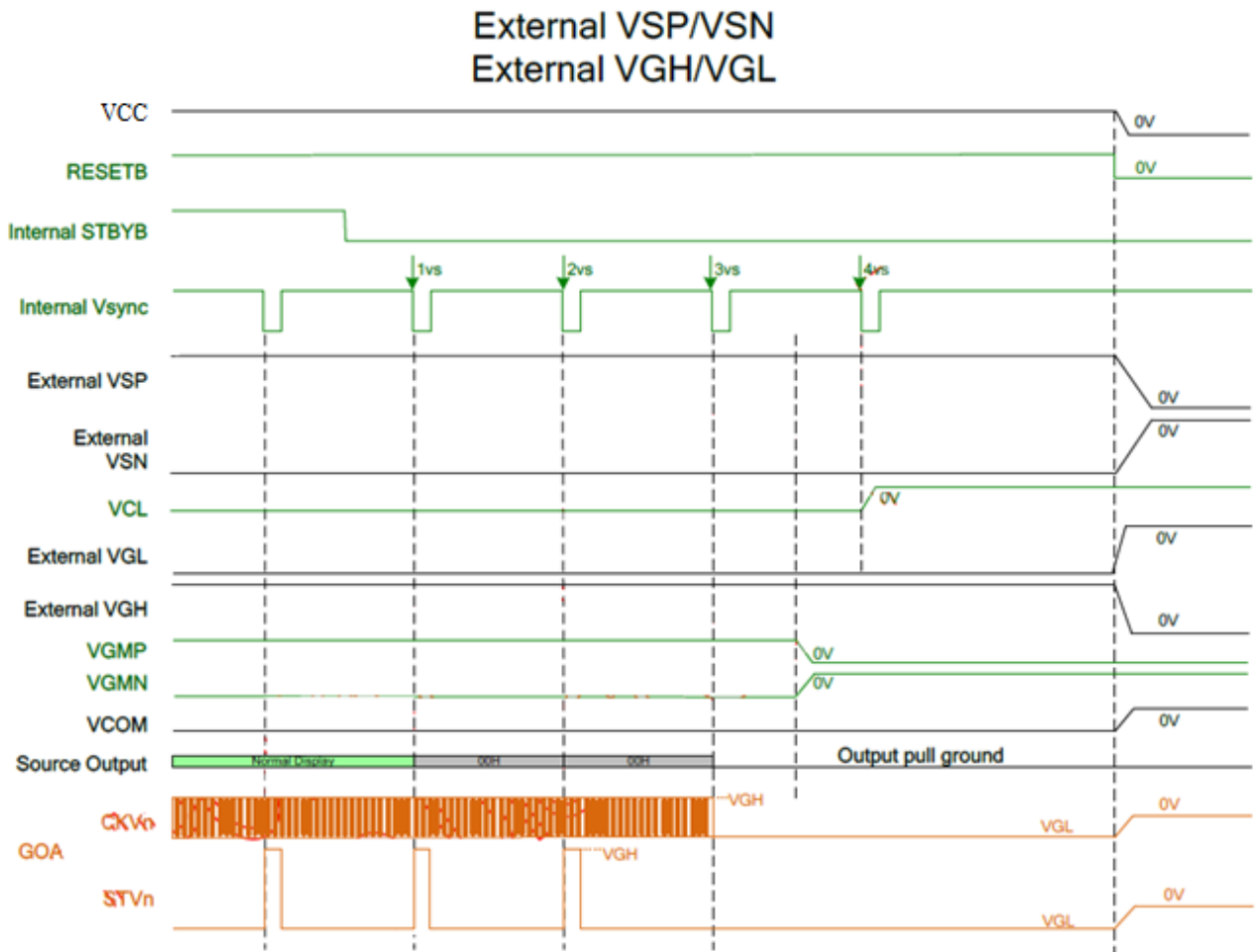

RAYSTAR

11. Optical Characteristics

Item	Symbol	Condition.	Min	Typ.	Max.	Unit	Remark	
Response time	Tr+ Tf	$\theta=0^\circ$ 、 $\Phi=0^\circ$	-	25	35	.ms	Note 3	
Contrast ratio	CR	At optimized viewing angle	800	1000	-	-	Note 4	
Color Chromaticity	White	Wx	$\theta=0^\circ$ 、 $\Phi=0$	0.272	0.322	0.372	-	Note 2,6,7
		Wy		0.294	0.344	0.394	-	
Viewing angle	Hor.	Θ_R	$CR \geq 10$	70	80	-	Deg.	Note 1
		Θ_L		70	80	-		
	Ver.	Φ_T		70	80	-		
		Φ_B		70	80	-		
Brightness	-	-	1000	1100	-	cd/m ²	Center of display	
Uniformity	(U)	-	70	-	-	%	Note 5	

Ta=25±2°C

Note 1: Definition of viewing angle range

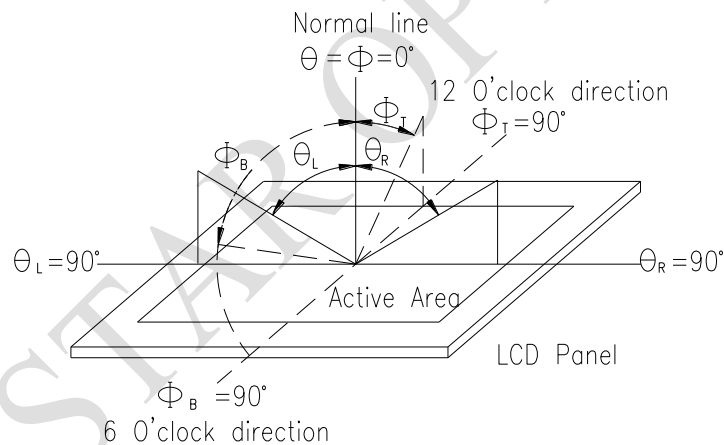

Fig. 11.1. Definition of viewing angle

Note 2: Test equipment setup:

After stabilizing and leaving the panel alone at a driven temperature for 10 minutes, the measurement should be executed. Measurement should be executed in a stable, windless, and dark room. Optical specifications are measured by Topcon BM-7 or BM-5 luminance meter 1.0° field of view at a distance of 50cm and normal direction.

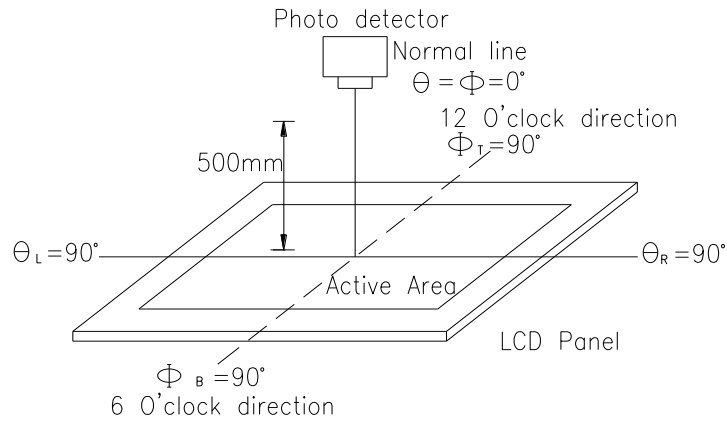
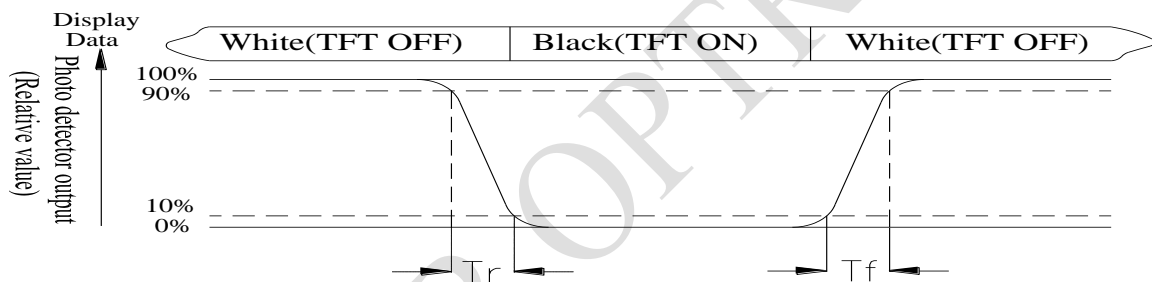

Fig. 11.2. Optical measurement system setup

Note 3: Definition of Response time:

The response time is defined as the LCD optical switching time interval between “White” state and “Black” state. Rise time, T_r , is the time between photo detector output intensity changed from 90% to 10%. And fall time, T_f , is the time between photo detector output intensity changed from 10% to 90%



Note 4: Definition of contrast ratio:

The contrast ratio is defined as the following expression.

$$\text{Contrast ratio (CR)} = \frac{\text{Luminance measured when LCD on the "White" state}}{\text{Luminance measured when LCD on the "Black" state}}$$

Note 5: Definition of Luminance Uniformity

Active area is divided into 9 measuring areas (reference the picture in below). Every measuring point is placed at the center of each measuring area.

Luminance Uniformity (U) = $L_{min}/L_{max} \times 100\%$

L = Active area length

W = Active area width



Fig11.3. Definition of uniformity

Note 6: Definition of color chromaticity (CIE 1931)

Color coordinates measured at the center point of LCD

Note 7: Measured at the center area of the panel when all the input terminals of LCD panel are electrically opened.

12. Reliability

Content of Reliability Test (Wide temperature, -20°C~70°C)

Environmental Test			
Test Item	Content of Test	Test Condition	Note
High Temperature storage	Endurance test applying the high storage temperature for a long time.	80°C 200hrs	2
Low Temperature storage	Endurance test applying the low storage temperature for a long time.	-30°C 200hrs	1,2
High Temperature Operation	Endurance test applying the electric stress (Voltage & Current) and the thermal stress to the element for a long time.	70°C 200hrs	—
Low Temperature Operation	Endurance test applying the electric stress under low temperature for a long time.	-20°C 200hrs	1
High Temperature/ Humidity Operation	The module should be allowed to stand at 60°C,90%RH max	60°C,90%RH 96hrs	1,2
Thermal shock resistance	The sample should be allowed stand the following 10 cycles of operation <div style="text-align: center;">  <p>-20°C 25°C 70°C</p> <p>30min 5min 30min</p> <p>1 cycle</p> </div>	-20°C/70°C 10 cycles	—
Vibration test	Endurance test applying the vibration during transportation and using.	Total fixed amplitude : 1.5mm Vibration Frequency : 10~55Hz One cycle 60 seconds to 3 directions of X,Y,Z for Each 15 minutes	3
Static electricity test	Endurance test applying the electric stress to the terminal.	VS=±600V(contact) ,±800v(air), RS=330Ω CS=150pF 10 times	—

Note1: No dew condensation to be observed.

Note2: The function test shall be conducted after 4 hours storage at the normal Temperature and humidity after remove from the test chamber.

Note3: The packing have to including into the vibration testing.

LCM Sample Estimate Feedback Sheet		
Module Number : _____		
1 、 Panel Specification :		
1. Panel Type :	<input type="checkbox"/> Pass	<input type="checkbox"/> NG , _____
2. View Direction :	<input type="checkbox"/> Pass	<input type="checkbox"/> NG , _____
3. Numbers of Dots :	<input type="checkbox"/> Pass	<input type="checkbox"/> NG , _____
4. View Area :	<input type="checkbox"/> Pass	<input type="checkbox"/> NG , _____
5. Active Area :	<input type="checkbox"/> Pass	<input type="checkbox"/> NG , _____
6. Operating Temperature :	<input type="checkbox"/> Pass	<input type="checkbox"/> NG , _____
7. Storage Temperature :	<input type="checkbox"/> Pass	<input type="checkbox"/> NG , _____
8. Others : _____		
2 、 Mechanical Specification :		
1. PCB Size :	<input type="checkbox"/> Pass	<input type="checkbox"/> NG , _____
2. Frame Size :	<input type="checkbox"/> Pass	<input type="checkbox"/> NG , _____
3. Material of Frame :	<input type="checkbox"/> Pass	<input type="checkbox"/> NG , _____
4. Connector Position :	<input type="checkbox"/> Pass	<input type="checkbox"/> NG , _____
5. Fix Hole Position :	<input type="checkbox"/> Pass	<input type="checkbox"/> NG , _____
6. Backlight Position :	<input type="checkbox"/> Pass	<input type="checkbox"/> NG , _____
7. Thickness of PCB :	<input type="checkbox"/> Pass	<input type="checkbox"/> NG , _____
8. Height of Frame to PCB :	<input type="checkbox"/> Pass	<input type="checkbox"/> NG , _____
9. Height of Module :	<input type="checkbox"/> Pass	<input type="checkbox"/> NG , _____
10. Others :	<input type="checkbox"/> Pass	<input type="checkbox"/> NG , _____
3 、 Relative Hole Size :		
1. Pitch of Connector :	<input type="checkbox"/> Pass	<input type="checkbox"/> NG , _____
2. Hole size of Connector :	<input type="checkbox"/> Pass	<input type="checkbox"/> NG , _____
3. Mounting Hole size :	<input type="checkbox"/> Pass	<input type="checkbox"/> NG , _____
4. Mounting Hole Type :	<input type="checkbox"/> Pass	<input type="checkbox"/> NG , _____
5. Others :	<input type="checkbox"/> Pass	<input type="checkbox"/> NG , _____
4 、 Backlight Specification :		
1. B/L Type :	<input type="checkbox"/> Pass	<input type="checkbox"/> NG , _____
2. B/L Color :	<input type="checkbox"/> Pass	<input type="checkbox"/> NG , _____
3. B/L Driving Voltage (Reference for LED Type) : <input type="checkbox"/> Pass <input type="checkbox"/> NG , _____		
4. B/L Driving Current :	<input type="checkbox"/> Pass	<input type="checkbox"/> NG , _____
5. Brightness of B/L :	<input type="checkbox"/> Pass	<input type="checkbox"/> NG , _____
6. B/L Solder Method :	<input type="checkbox"/> Pass	<input type="checkbox"/> NG , _____
7. Others :	<input type="checkbox"/> Pass	<input type="checkbox"/> NG , _____

>> Go to page 2 <<

Module Number : _____

5、Electronic Characteristics of Module :

1.Input Voltage :	<input type="checkbox"/> Pass	<input type="checkbox"/> NG , _____
2.Supply Current :	<input type="checkbox"/> Pass	<input type="checkbox"/> NG , _____
3.Driving Voltage for LCD :	<input type="checkbox"/> Pass	<input type="checkbox"/> NG , _____
4.Contrast for LCD :	<input type="checkbox"/> Pass	<input type="checkbox"/> NG , _____
5.B/L Driving Method :	<input type="checkbox"/> Pass	<input type="checkbox"/> NG , _____
6.Negative Voltage Output :	<input type="checkbox"/> Pass	<input type="checkbox"/> NG , _____
7.Interface Function :	<input type="checkbox"/> Pass	<input type="checkbox"/> NG , _____
8.LCD Uniformity :	<input type="checkbox"/> Pass	<input type="checkbox"/> NG , _____
9.ESD test :	<input type="checkbox"/> Pass	<input type="checkbox"/> NG , _____
10.Others :	<input type="checkbox"/> Pass	<input type="checkbox"/> NG , _____

6、Summary :

Sales signature : _____

Customer Signature : _____

Date : / /

X-ON Electronics

Largest Supplier of Electrical and Electronic Components

Click to view similar products for [TFT Displays & Accessories](#) category:

Click to view products by [Raystar](#) manufacturer:

Other Similar products are found below :

[F3ET2-005-150](#) [HDA430T-3G1H](#) [NB7W-KBA04](#) [NB-ATT01](#) [NB5Q-ATT01](#) [NB5Q-KBA04](#) [NB-CN001](#) [OAI-80038AA-2008-A](#) [315-U004B15300](#) [TCG121WXLRXVNNANX35](#) [EIC-LCD-1080P](#) [T-55619GD065J-LW-ABN](#) [NLB150XG02L-01](#) [NL192108AC10-01D](#) [NL6448AC18-08F](#) [NL8060BC26-35BA](#) [NL6448BC26-26D](#) [NL8060BC31-50F](#) [TM070DDHG03-40](#) [PTPW16-070WV1S02](#) [PTPW16-084SV1S02](#) [MTD0300ECP06DF-1](#) [4DLCD-35480320-CTP-IPS](#) [4DLCD-35480320-IPS](#) [4DLCD-35480320-RTP-IPS](#) [4DLCD-50800480-CTP-IPS](#) [RFA6400E-AWH-DNG](#) [RFE430V-AZW-DNS](#) [RFF70BQ-1IW-DBG](#) [RFF70VA2-1IW-DHS](#) [RFH700A8-AYH-MNN](#) [RFK101VF-1YH-LHG](#) [RFS52VA-1ZH-DHN](#) [SM-RVT101HVHFWN00](#) [SM-RVT101HVHNWC00](#) [SM-RVT101HVHNWCA0](#) [SM-RVT101HVHNWN00](#) [SM-RVT101HVLFWCA0](#) [SM-RVT101HVLNWCA0](#) [SM-RVT35HHTFWCA0](#) [SM-RVT35HHTNWCA0](#) [SM-RVT43HLTFWCA0](#) [SM-RVT43HLTNWCA0](#) [SM-RVT50HQTFWCA0](#) [SM-RVT50HQTNWCA0](#) [SM-RVT70AQLFWR00](#) [SM-RVT70AQLNWR00](#) [SM-RVT70HSLFWCA0](#) [SM-RVT70HSMFWCA0](#) [SM-RVT70HSMFWN00](#)