



**RAYSTAR**

# 曜凌光電股份有限公司

住址: 42878 台中市大雅区科雅路 25 號 5F WEB: <http://www.Raystar-Optronics.com>  
5F., No.25, Keya Rd., Daya Dist., Taichung E-mail: [sales@raystar-optronics.com](mailto:sales@raystar-optronics.com)  
City 428, Taiwan Tel:886-4-2565-0761 Fax : 886-4-2565-0760

## RFS520A-ALH-DNN

---

### SPECIFICATION

CUSTOMER:

<b>APPROVED BY</b>	
<b>PCB VERSION</b>	
<b>DATE</b>	

FOR CUSTOMER USE ONLY

<b>SALES BY</b>	<b>APPROVED BY</b>	<b>CHECKED BY</b>	<b>PREPARED BY</b>

Release DATE:

TFT Display Inspection Specification: <https://www.raystar-optronics.com/download/products.htm>

Precaution in use of TFT module: <https://www.raystar-optronics.com/download/declaration.htm>

---

## Revision History

VERSION	DATE	REVISED PAGE NO.	Note
0	2017/02/21		First issue

RAYSTAR OPTRONICS

# Contents

1. Module Classification Information
2. Summary
3. General Specification
4. Interface
5. Contour Drawing
6. Block Diagram
7. Absolute Maximum Ratings
8. Electrical Characteristics
9. DC Characteristics
10. AC Characteristics
11. Optical Characteristics
12. Reliability
13. Display start address setting
14. Other



## 2.Summary

TFT 5.2" is a TN transmissive type color active matrix TFT liquid crystal display that use amorphous silicon TFT as switching devices. This module is a composed of a TFT\_LCD module, It is usually designed for industrial application and this module follows RoHs,

RAYSTAR OPTRONICS

---

### 3.General Specifications

- Size: 5.2 inch
- Dot Matrix: 480 x RGBx128 dots
- Module dimension: 140.4 x 49.87 x 3.0 mm
- Active area: 127.152 x 33.9072 mm
- Dot pitch: 0.0883 x 0.2649 mm
- LCD type: TFT, Normally White, Transmissive
- View Direction: 6 o'clock
- Gray Scale Inversion Direction: 12 o'clock
- Aspect Ratio: Bar Type
- Backlight Type: LED, Normally White
- Driver IC: ST7252 Or Equal
- Interface: RGB 24bit
- With /Without TP: Without TP
- Surface: Glare

\*Color tone slight changed by temperature and driving voltage.

## 4.Interface

### 4.1. LCM PIN Definition

Pin	Symbol	Function	Remark
1	VLED-	Power for LED backlight cathode	
2	VLED+	Power for LED backlight anode	
3	GND	Power ground	
4	VCC	Power voltage	
5	R0	Red data (LSB)	
6	R1	Red data	
7	R2	Red data	
8	R3	Red data	
9	R4	Red data	
10	R5	Red data	
11	R6	Red data	
12	R7	Red data (MSB)	
13	G0	Green data (LSB)	
14	G1	Green data	
15	G2	Green data	
16	G3	Green data	
17	G4	Green data	
18	G5	Green data	
19	G6	Green data	
20	G7	Green data (MSB)	
21	B0	Blue data (LSB)	
22	B1	Blue data	
23	B2	Blue data	
24	B3	Blue data	
25	B4	Blue data	
26	B5	Blue data	
27	B6	Blue data	
28	B7	Blue data (MSB)	
29	GND	Power ground	
30	CLK	Pixel clock (DCLK)	
31	LR	Right /Left selection; Default R/L=High	Note1,2
32	HSYNC	Horizontal sync signal; negative polarity	
33	VSYNC	Vertical sync signal; negative polarity	
34	NC	No connection	
35	UD	Up/down selection; Default U/D=High	Note1,2
36	RESET	Reset signal	
37	NC	No connection	
38	NC	No connection	
39	NC	No connection	
40	NC	No connection	

Note 1: Selection of scanning mode, and LR,UD Pull High 10KΩ on FPC

Setting of scan control input		Scanning direction
UD	LR	
L	H	Down to up, left to right
H	L	Up to down, right to left
L	L	Down to up, right to left
H	H	Up to down, left to right

Note 2: Definition of scanning direction. Refer to the figure as below:

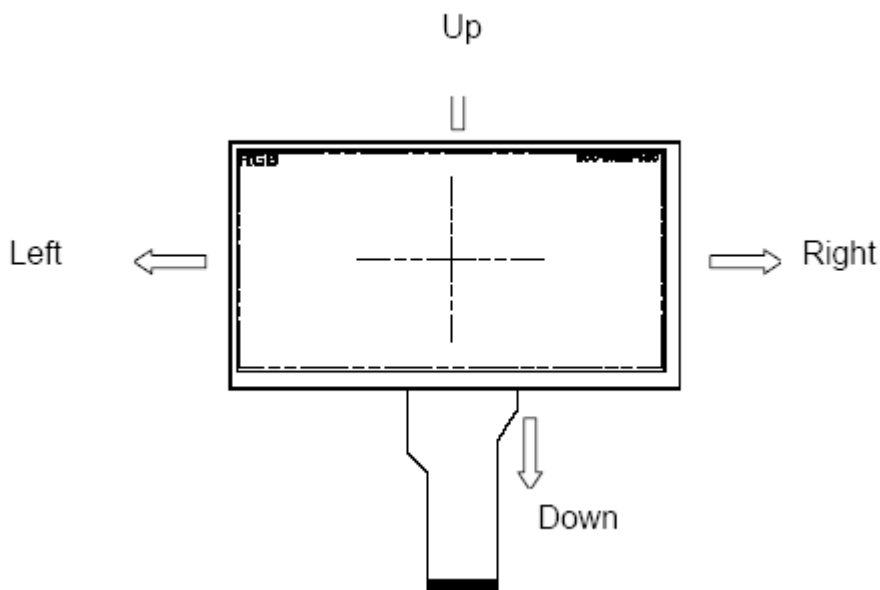



# 5. Contour Drawing

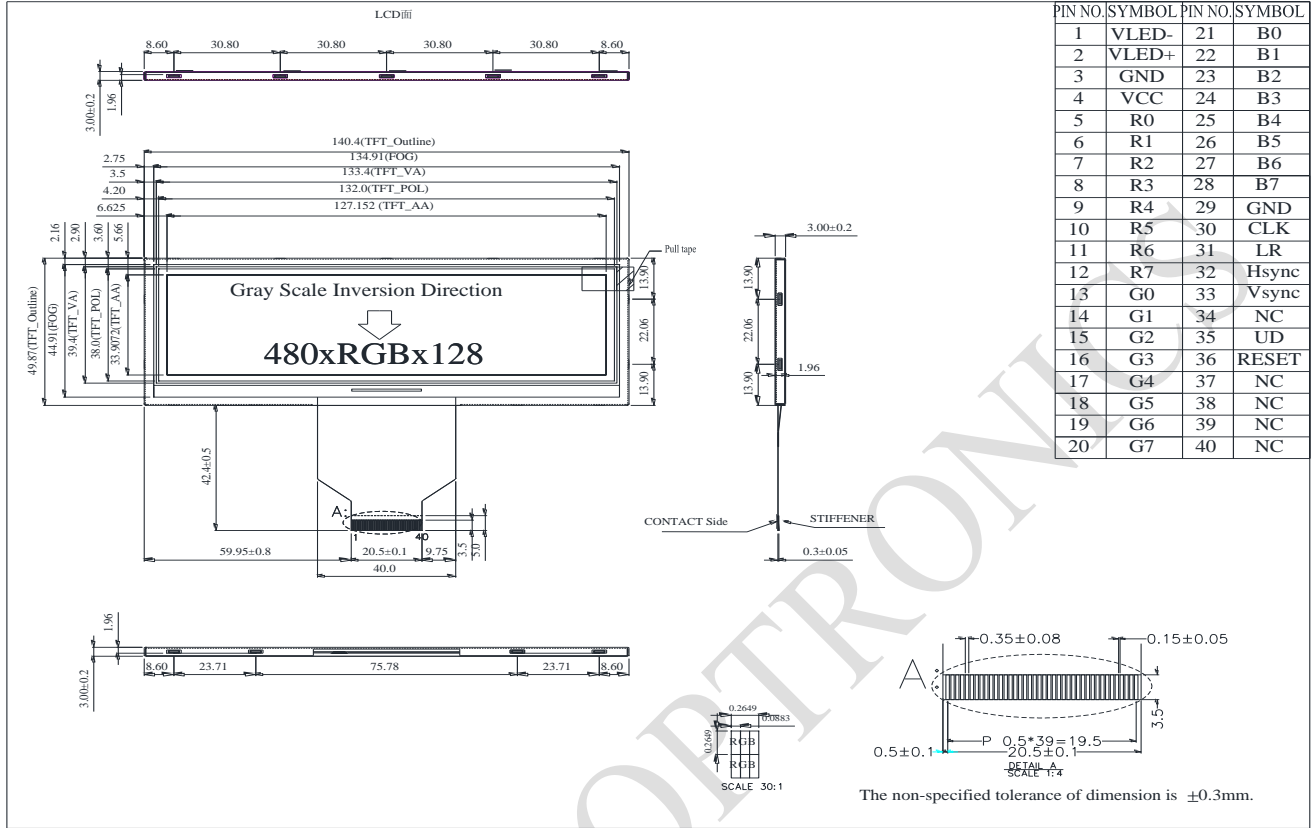

## 6. Block Diagram

### LCD Panel

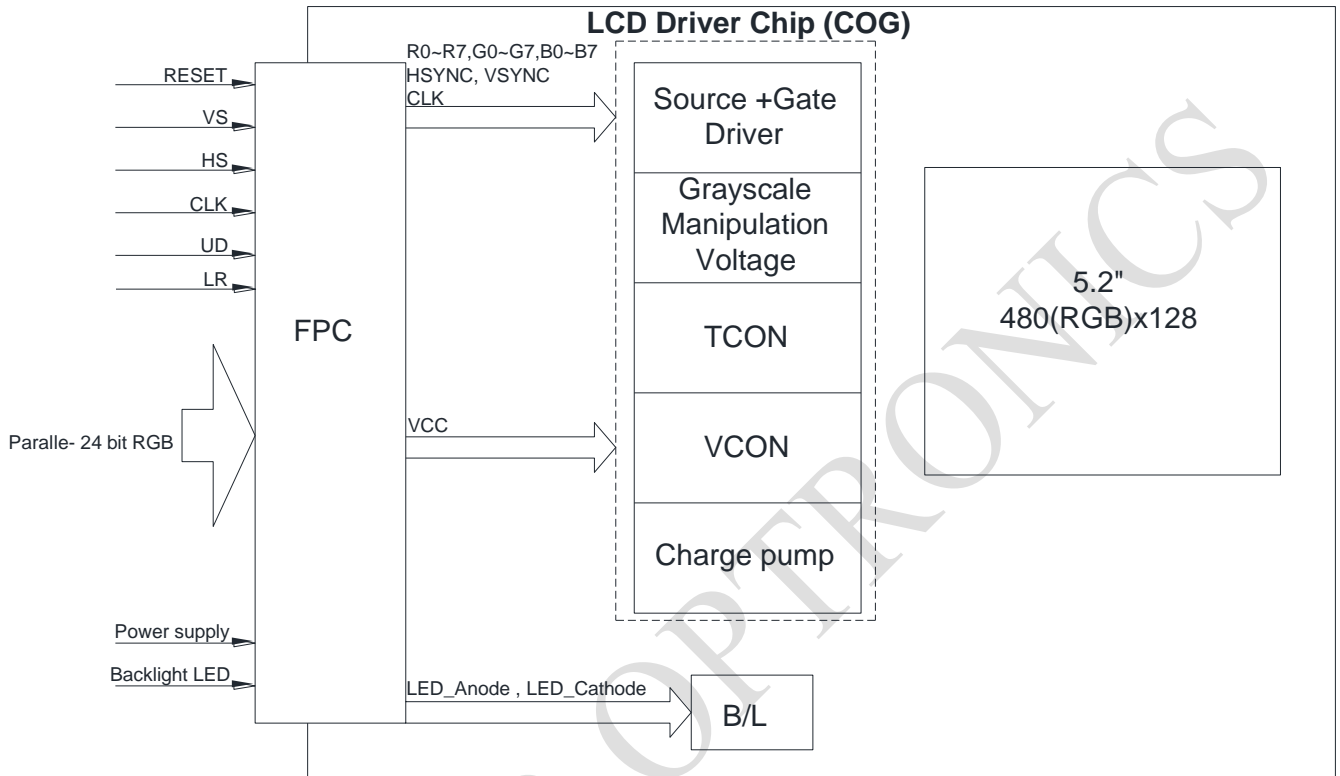

## 7. Absolute Maximum Ratings

Item	Symbol	Min	Typ	Max	Unit
Operating Temperature	TOP	-20	—	+70	°C
Storage Temperature	TST	-30	—	+80	°C

Note: Device is subject to be damaged permanently if stresses beyond those absolute maximum ratings listed above

Temp.  $\leq 60^{\circ}\text{C}$ , 90% RH MAX. Temp.  $> 60^{\circ}\text{C}$ , Absolute humidity shall be less than 90% RH at  $60^{\circ}\text{C}$

RAYSTAR OPTRONICS

## 8. Electrical Characteristics

### 8.1. Operating conditions:

Item	Symbol	Condition	Min	Typ	Max	Unit
Supply Voltage For LCM	VCC	—	3.0	3.3	3.6	V
Supply Current For LCM	ICC	-	—	20	—	mA

### 8.2. LED driving conditions

Parameter	Symbol	Min.	Typ.	Max.	Unit	Remark
LED current		-	80	-	mA	
LED voltage	VLED+	16.8	18.6	21	V	Note 1
LED Life Time		-	50,000	-	Hr	Note 2,3,4

Note 1 : There are 1 Groups LED

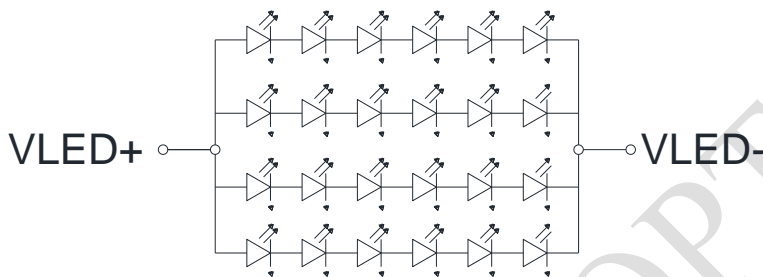

Note 2 :  $T_a = 25\text{ }^\circ\text{C}$

Note 3 : Brightness to be decreased to 50% of the initial value

Note 4 : The single LED lamp case

## 9.DC CHARATERISTICS

Parameter	Symbol	Rating			Unit	Condition
		Min	Typ	Max		
Low level input voltage	$V_{IL}$	0	-	0.3VCC	V	
High level input voltage	$V_{IH}$	0.7VCC	-	VCC	V	

RAYSTAR OPTRONICS

# 10.AC CHARATERISTICS

Parallel SYNC mode RGB input timing table

Item	Symbol	Min	Typ	Max	Unit	
CLK frequency	Fclk	8	9	12	MHz	
DCLK Period	Tclk	83	111	125	ns	
HSYNC	Period Time	Th	485	531	598	DCLK
	Display Period	Thdisp	-	480	-	DCLK
	Back Porch	Thbp	3	43	43	DCLK
	Front Porch	Thfp	2	8	75	DCLK
	Pulse Width	Thw	2	4	75	DCLK
VSYNC	Period Time	Tv	276	292	321	H
	Display Period	Tvdisp	-	272	-	H
	Back Porch	Tvbp	2	12	12	H
	Front Porch	Tvfp	2	8	37	H
	Pulse Width	Tvw	2	4	37	H

## 10.1. Timing Diagram

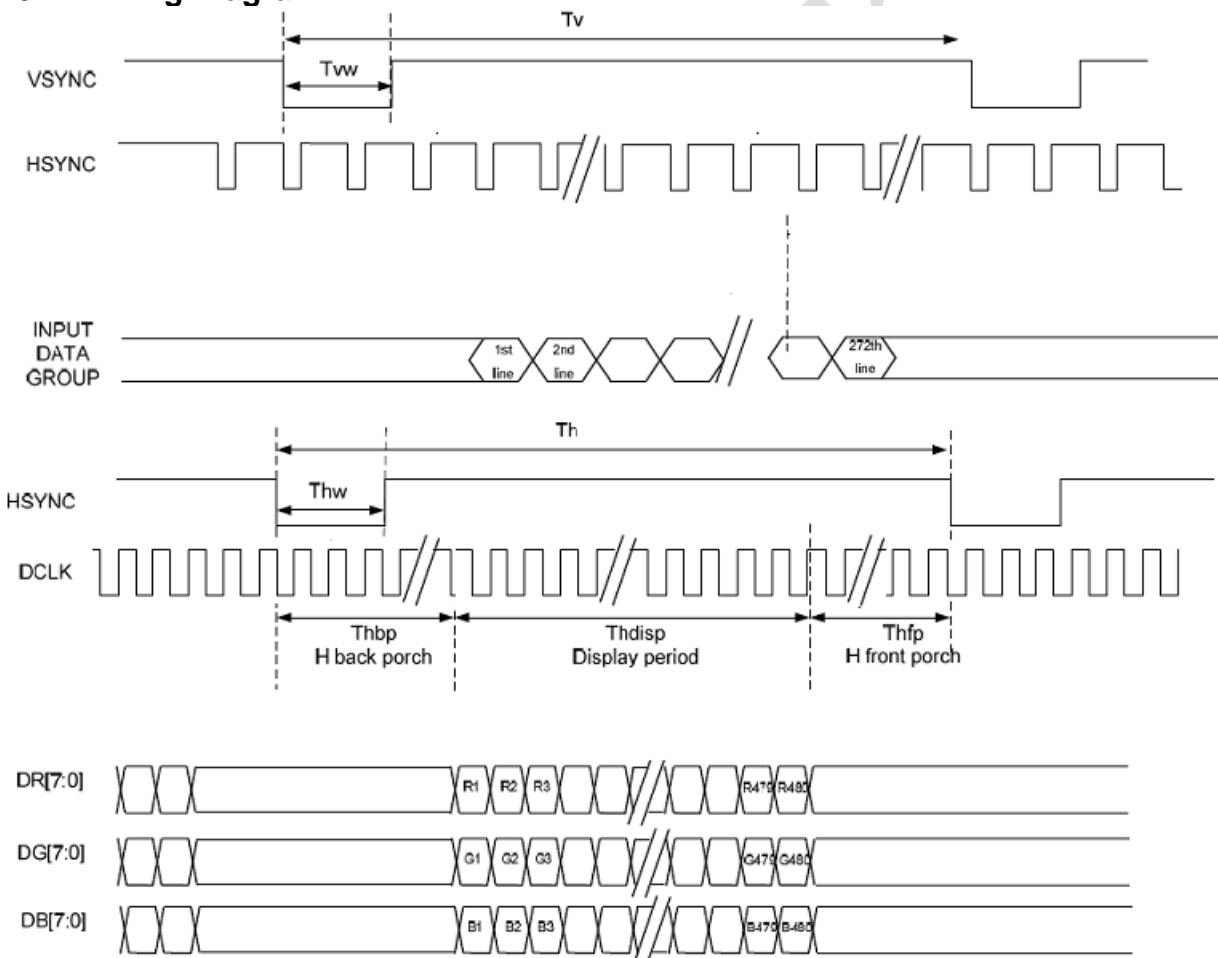

## 11. Optical Characteristics

Item	Symbol	Condition.	Min	Typ.	Max.	Unit	Remark
Response time	Tr+ Tf	$\theta=0^\circ$ 、 $\phi=0^\circ$	-	35	-	.ms	Note 3
Contrast ratio	CR	At optimized viewing angle	300	500	-	-	Note 4
Color Chromaticity	White	Wx	$\theta=0^\circ$ 、 $\phi=0$	0.24	0.29	0.34	Note 2,5
		Wy		0.26	0.31	0.36	
Viewing angle (Gray Scale Inversion Direction)	Hor.	$\Theta_R$	CR $\geq$ 10	55	65	-	Deg. Note 1
		$\Theta_L$		55	65	-	
	Ver.	$\Phi_T$		55	65	-	
		$\Phi_B$		45	55	-	
Brightness	-	-	1000	1100	-	-	Center of display

Ta=25±2°C, IL=80mA

Note 1: Definition of viewing angle range

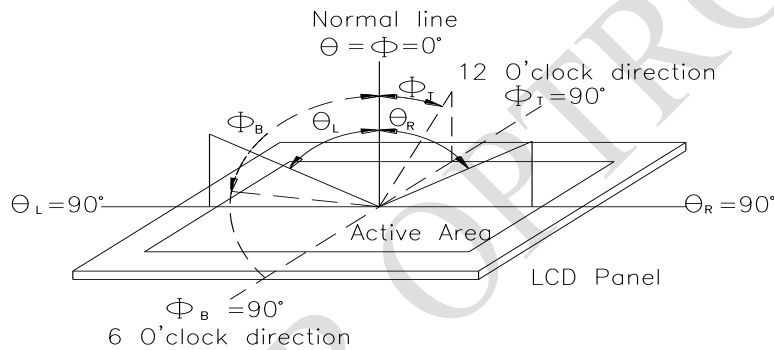

Fig.11.1. Definition of viewing angle

Note 2: Test equipment setup:

After stabilizing and leaving the panel alone at a driven temperature for 10 minutes, the measurement should be executed. Measurement should be executed in a stable, windless, and dark room. Optical specifications are measured by Topcon BM-7orBM-5 luminance meter 1.0° field of view at a distance of 50cm and normal direction.

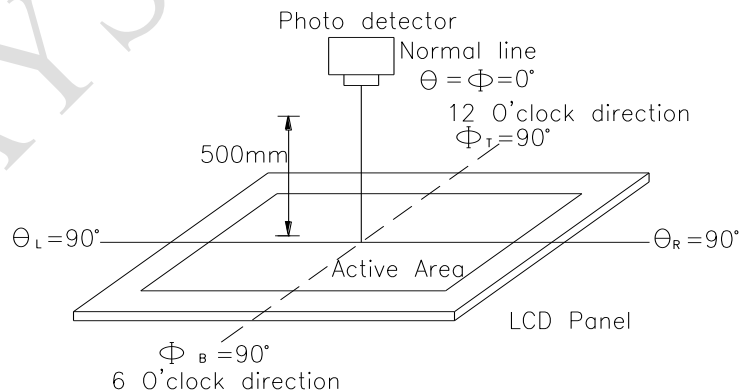
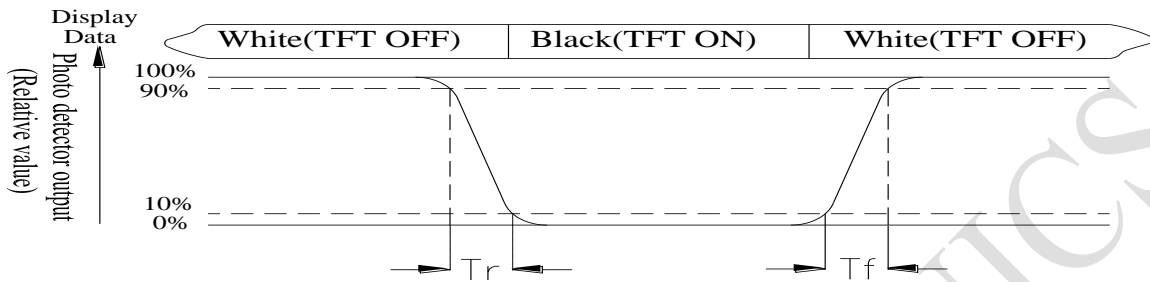

Fig. 11.2. Optical measurement system setup

**Note 3: Definition of Response time:**

The response time is defined as the LCD optical switching time interval between “White” state and “Black” state. Rise time,  $T_r$ , is the time between photo detector output intensity changed from 90% to 10%. And fall time,  $T_f$ , is the time between photo detector output intensity changed from 10% to 90%



**Note 4: Definition of contrast ratio:**

The contrast ratio is defined as the following expression.

$$\text{Contrast ratio (CR)} = \frac{\text{Luminance measured when LCD on the "White" state}}{\text{Luminance measured when LCD on the "Black" state}}$$

Note 5: White  $V_i = V_{i50} \pm 1.5V$

Black  $V_i = V_{i50} \pm 2.0V$

“±” means that the analog input signal swings in phase with VCOM signal.

“±” means that the analog input signal swings out of phase with VCOM signal.

The 100% transmission is defined as the transmission of LCD panel when all the input terminals of module are electrically opened.

**Note 6: Definition of color chromaticity (CIE 1931)**

Color coordinates measured at the center point of LCD

Note 7: Measured at the center area of the panel when all the input terminals of LCD panel are electrically opened.



## 12. Reliability

Content of Reliability Test (Wide temperature, -20°C ~70°C)

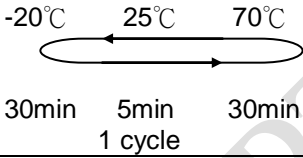
Environmental Test			
Test Item	Content of Test	Test Condition	Note
High Temperature storage	Endurance test applying the high storage temperature for a long time.	80°C 200hrs	2
Low Temperature storage	Endurance test applying the low storage temperature for a long time.	-30°C 200hrs	1,2
High Temperature Operation	Endurance test applying the electric stress (Voltage & Current) and the thermal stress to the element for a long time.	70°C 200hrs	—
Low Temperature Operation	Endurance test applying the electric stress under low temperature for a long time.	-20°C 200hrs	1
High Temperature/ Humidity Operation	The module should be allowed to stand at 60°C, 90%RH max	60°C, 90%RH 96hrs	1,2
Thermal shock resistance	The sample should be allowed stand the following 10 cycles of operation  <div style="text-align: center;">  <p>-20°C      25°C      70°C</p> <p>30min    5min    30min</p> <p>1 cycle</p> </div>	-20°C/70°C 10 cycles	—
Vibration test	Endurance test applying the vibration during transportation and using.	Total fixed amplitude : 1.5mm Vibration Frequency : 10~55Hz One cycle 60 seconds to 3 directions of X,Y,Z for Each 15 minutes	3
Static electricity test	Endurance test applying the electric stress to the terminal.	VS=±600V(contact) ,±800v(air), RS=330Ω CS=150pF 10 times	—

Note1: No dew condensation to be observed.

Note2: The function test shall be conducted after 4 hours storage at the normal Temperature and humidity after remove from the test chamber.

Note3: The packing have to including into the vibration testing.

### 13. Display start address setting

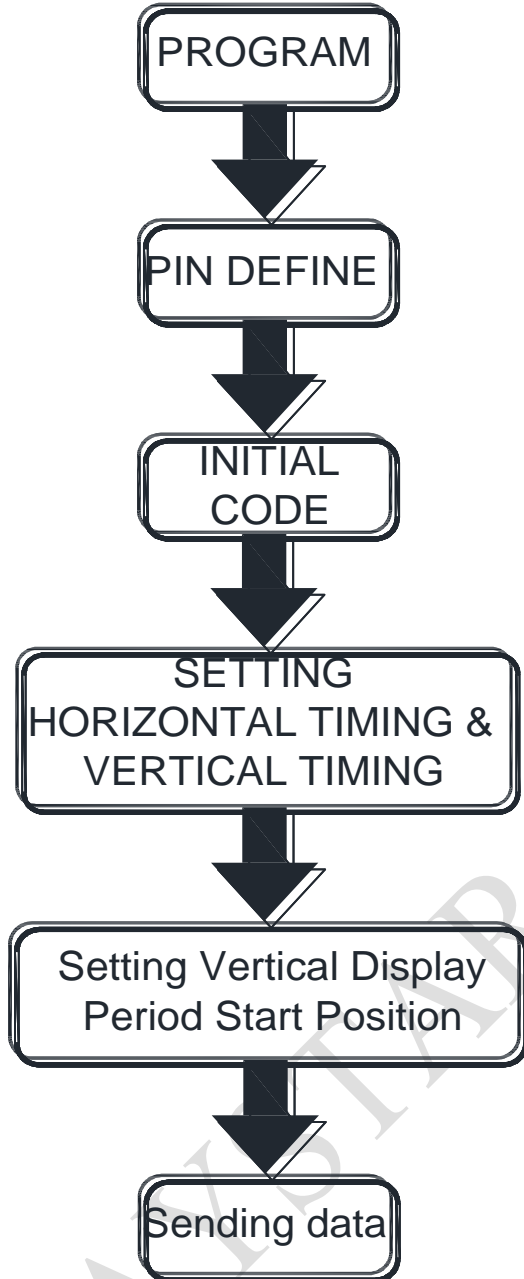

Ex.

One horizontal line=0x0213

VS period time=0x0124

HS Blanking=0x2b

VS Blanking=0x10

HS Front Porch=0x05

VS Front Porch=0x08

Suggestion :

Vertical Display Period

Start Position=0x44

Note :

For different Controller ICs, the value of vertical display period start position need to be adjusted accordingly.

**LCM Sample Estimate Feedback Sheet**

**Module Number :** \_\_\_\_\_

**1 、 Panel Specification :**

1. Panel Type :	<input type="checkbox"/> Pass	<input type="checkbox"/> NG , _____
2. View Direction :	<input type="checkbox"/> Pass	<input type="checkbox"/> NG , _____
3. Numbers of Dots :	<input type="checkbox"/> Pass	<input type="checkbox"/> NG , _____
4. View Area :	<input type="checkbox"/> Pass	<input type="checkbox"/> NG , _____
5. Active Area :	<input type="checkbox"/> Pass	<input type="checkbox"/> NG , _____
6. Operating Temperature :	<input type="checkbox"/> Pass	<input type="checkbox"/> NG , _____
7. Storage Temperature :	<input type="checkbox"/> Pass	<input type="checkbox"/> NG , _____
8. Others :	_____	

**2 、 Mechanical Specification :**

1. PCB Size :	<input type="checkbox"/> Pass	<input type="checkbox"/> NG , _____
2. Frame Size :	<input type="checkbox"/> Pass	<input type="checkbox"/> NG , _____
3. Material of Frame :	<input type="checkbox"/> Pass	<input type="checkbox"/> NG , _____
4. Connector Position :	<input type="checkbox"/> Pass	<input type="checkbox"/> NG , _____
5. Fix Hole Position :	<input type="checkbox"/> Pass	<input type="checkbox"/> NG , _____
6. Backlight Position :	<input type="checkbox"/> Pass	<input type="checkbox"/> NG , _____
7. Thickness of PCB :	<input type="checkbox"/> Pass	<input type="checkbox"/> NG , _____
8. Height of Frame to PCB :	<input type="checkbox"/> Pass	<input type="checkbox"/> NG , _____
9. Height of Module :	<input type="checkbox"/> Pass	<input type="checkbox"/> NG , _____
10. Others :	<input type="checkbox"/> Pass	<input type="checkbox"/> NG , _____

**3 、 Relative Hole Size :**

1. Pitch of Connector :	<input type="checkbox"/> Pass	<input type="checkbox"/> NG , _____
2. Hole size of Connector :	<input type="checkbox"/> Pass	<input type="checkbox"/> NG , _____
3. Mounting Hole size :	<input type="checkbox"/> Pass	<input type="checkbox"/> NG , _____
4. Mounting Hole Type :	<input type="checkbox"/> Pass	<input type="checkbox"/> NG , _____
5. Others :	<input type="checkbox"/> Pass	<input type="checkbox"/> NG , _____

**4 、 Backlight Specification :**

1. B/L Type :	<input type="checkbox"/> Pass	<input type="checkbox"/> NG , _____
2. B/L Color :	<input type="checkbox"/> Pass	<input type="checkbox"/> NG , _____
3. B/L Driving Voltage (Reference for LED Type) :	<input type="checkbox"/> Pass	<input type="checkbox"/> NG , _____
4. B/L Driving Current :	<input type="checkbox"/> Pass	<input type="checkbox"/> NG , _____
5. Brightness of B/L :	<input type="checkbox"/> Pass	<input type="checkbox"/> NG , _____
6. B/L Solder Method :	<input type="checkbox"/> Pass	<input type="checkbox"/> NG , _____
7. Others :	<input type="checkbox"/> Pass	<input type="checkbox"/> NG , _____

>> **Go to page 2** <<

<b>Module Number :</b> _____		
<b>5 · <u>Electronic Characteristics of Module</u> :</b>		
1.Input Voltage :	<input type="checkbox"/> Pass	<input type="checkbox"/> NG , _____
2.Supply Current :	<input type="checkbox"/> Pass	<input type="checkbox"/> NG , _____
3.Driving Voltage for LCD :	<input type="checkbox"/> Pass	<input type="checkbox"/> NG , _____
4.Contrast for LCD :	<input type="checkbox"/> Pass	<input type="checkbox"/> NG , _____
5.B/L Driving Method :	<input type="checkbox"/> Pass	<input type="checkbox"/> NG , _____
6.Negative Voltage Output :	<input type="checkbox"/> Pass	<input type="checkbox"/> NG , _____
7.Interface Function :	<input type="checkbox"/> Pass	<input type="checkbox"/> NG , _____
8.LCD Uniformity :	<input type="checkbox"/> Pass	<input type="checkbox"/> NG , _____
9.ESD test :	<input type="checkbox"/> Pass	<input type="checkbox"/> NG , _____
10.Others :	<input type="checkbox"/> Pass	<input type="checkbox"/> NG , _____
<b>6 · <u>Summary</u> :</b>		
<p style="text-align: right; margin-right: 100px;">Sales signature : _____</p> <p style="text-align: right; margin-right: 100px;">Customer Signature : _____      <u>Date</u> :   /   / _____</p>		

## X-ON Electronics

Largest Supplier of Electrical and Electronic Components

*Click to view similar products for [TFT Displays & Accessories](#) category:*

*Click to view products by [Raystar](#) manufacturer:*

Other Similar products are found below :

[OAI-80038AA-2013-A](#) [HDA430T-3G1H](#) [EA CARREDIPTFT02](#) [NL6448BC20-21D](#) [TM022HDHT11-00](#) [NB7W-KBA04](#) [NB-ATT01](#)  
[NB5Q-ATT01](#) [NB5Q-KBA04](#) [NB-CN001](#) [NL12880BC20-05](#) [NL8060BC26-35C](#) [NL8060BC26-35F](#) [TCG104SVLQAPNN-AN20](#) [OAI-](#)  
[80038AA-2008-A](#) [315-U004B15300](#) [UMSH-8596MD-34T \(REV D\)](#) [98-0003-3490-8](#) [1044278](#) [1029309](#) [1060549](#) [DE 127-TU-30/7,5](#) [DE](#)  
[128-TU-20/7,5](#) [EP-LK007TFTPCAP](#) [FR7.0A00](#) [RC2002A-TIG-CSX](#) [NL6448BC2021C](#) [TX17D01VM2EAB](#) [TX14D23VM5BAA](#)  
[TCG121WXLRXVNNANX35](#) [EIC-LCD-1080P](#) [T272480C07VR01](#) [1060632](#) [TCG070WVLPAANN-AN50](#) [TCG035QVLPDANN-GN50](#)  
[1060630](#) [RFE430V-AIW-DNG](#) [T-55619GD065J-LW-ABN](#) [NHD-1.8-128160EF-SSXN-FT](#) [TCG104SVLPEANN-AN30](#) [NL6448BC33-70](#)  
[NL192108BC18-06F](#) [NLB150XG02L-01](#) [NL6448BC20-30D](#) [NL10276BC16-06](#) [NL192108AC10-01D](#) [NL6448AC18-08F](#) [NL6448BC20-30F](#)  
[NL12880BC20-05BD](#) [NL12880BC20-05D](#)