

VRRM	IF (TC≤135℃)	QC
650V	35A	66nC

Applications:

- Switch Mode Power Supplies
- Power Factor Correction
- Motor drive, PV Inverter, Wind Power Station

Features:

- Zero Reverse Recovery Current
- Zero Forward Recovery Voltage
- Positive Temperature Coefficient on VF
- Temperature-independent Switching
- 175°C Operating Junction Temperature

Benefits:

- Replace Bipolar with Unipolar Device
- Reduction of Heat Sink Size
- Parallel Devices Without Thermal Runaway
- Essentially No Switching Losses

Ordering Information

Part Number	Package	Marking	Packing	Qty.
RSS30065W	TO-247-2	RSS30065W	Tube	30 PCS

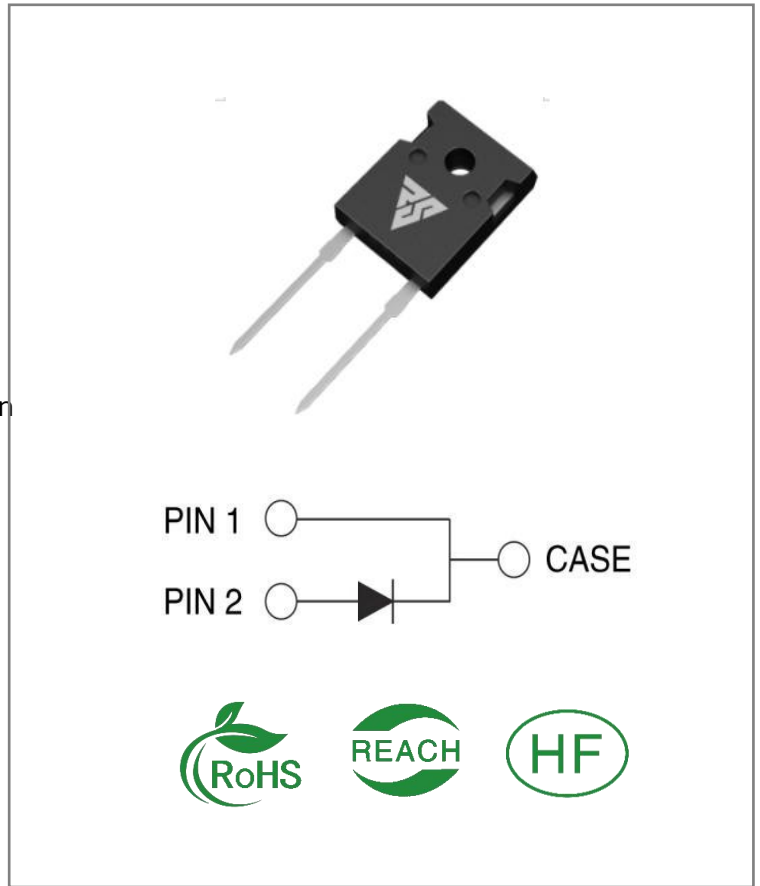

Maximum Ratings (T_J= 25°C unless otherwise specified)

Symbol	Parameter	Value	Unit	Test Conditions	Note
VRRM	Repetitive Peak Reverse Voltage	650	V	TC = 25°C	
VRSM	Surge Peak Reverse Voltage	650	V	TC = 25°C	
VR	DC Blocking Voltage	650	V	TC = 25°C	
IF	Forward Current	35 30	A	TC ≤ 135°C TC ≤ 143°C	
IFRM	Repetitive Peak Forward Surge Current	210	A	TC = 25°C, tp =8.3ms, Half Sine Wave	
Ptot	Power Dissipation	234	W	TC = 25°C	Fig.3
TC	Maximum Case Temperature	143	°C		
TJ,TST G	Operating Junction and Storage Temperature	-55 to175	°C		

Electrical Characteristics (T_J= 25°C unless otherwise specified)

Symbol	Parameter	Typ.	Max.	Unit	Test Conditions	Note
VF	Forward Voltage	1.5 1.78	1.8 2.3	V	IF = 30A, T _J = 25°C IF = 30A, T _J = 175°C	Fig.1
IR	Reverse Current	2 15	20 200	μA	VR = 650V, T _J = 25°C VR = 650V, T _J = 175°C	Fig.2
C	Total Capacitance	1805 176 145	/	pF	VR = 1V, T _J = 25°C, f = 1MHz VR = 200V, T _J = 25°C, f = 1MHz VR = 400V, T _J = 25°C, f = 1MHz	Fig.5
QC	Total Capacitive Charge	66	/	nC	VR =650V,	Fig.4

Thermal Characteristics (T_J= 25°C unless otherwise specified)

Symbol	Parameter	Typ.	Unit	Note
RθJC	Thermal Resistance from Junction to Case	0.64	°C/W	Fig.6

Typical Feature Curve

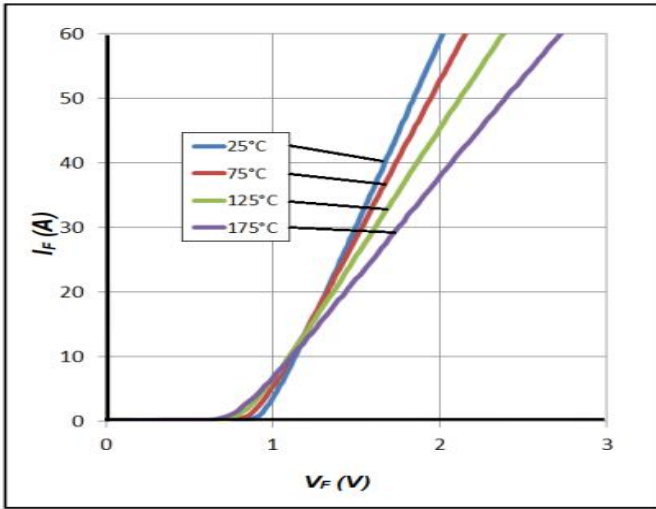

Figure 1. Forward Characteristics

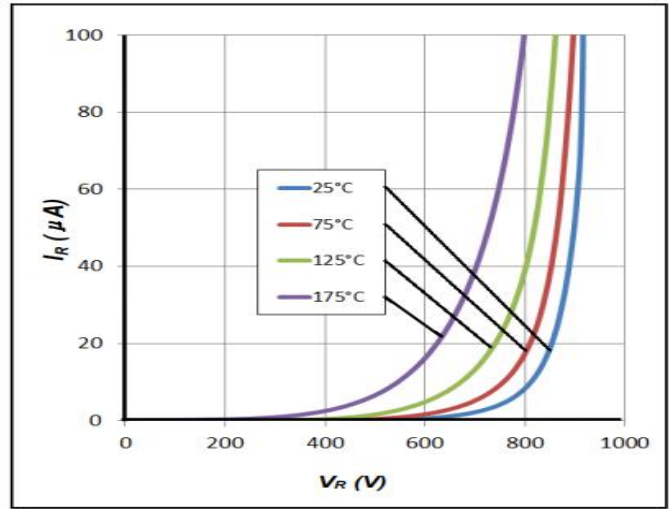

Figure 2. Reverse Characteristics

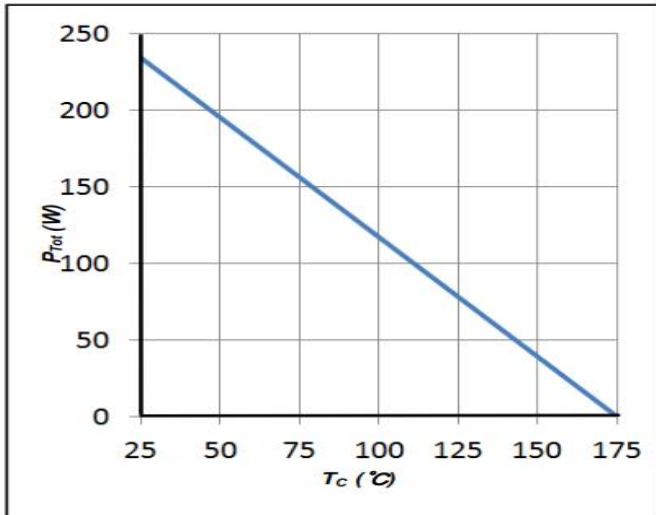

Figure 3. Power Derating

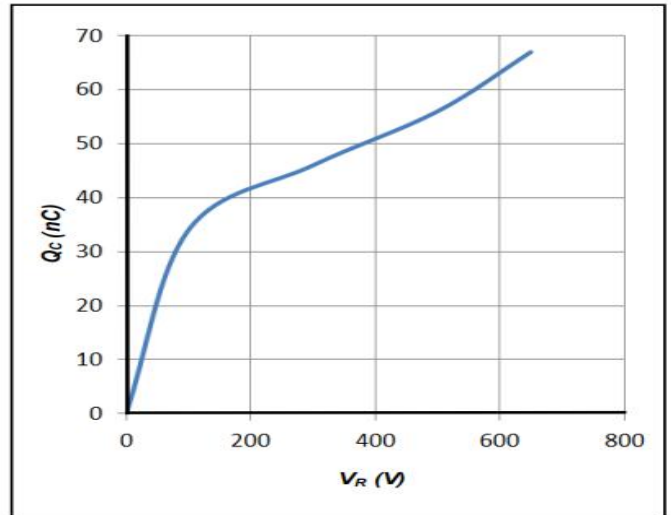

Figure 4. Total Capacitive Charge vs. Reverse Voltage

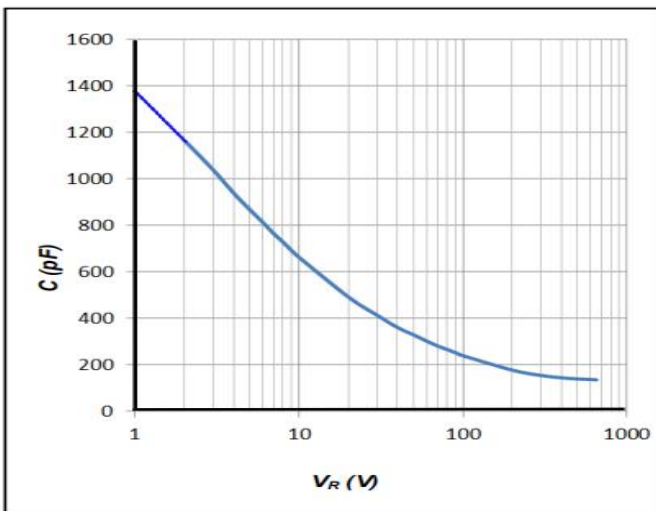

Figure 5. Total Capacitance vs. Reverse Voltage

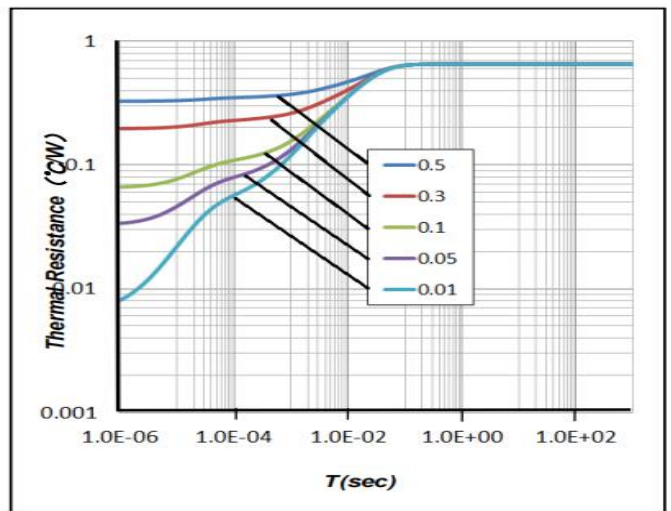
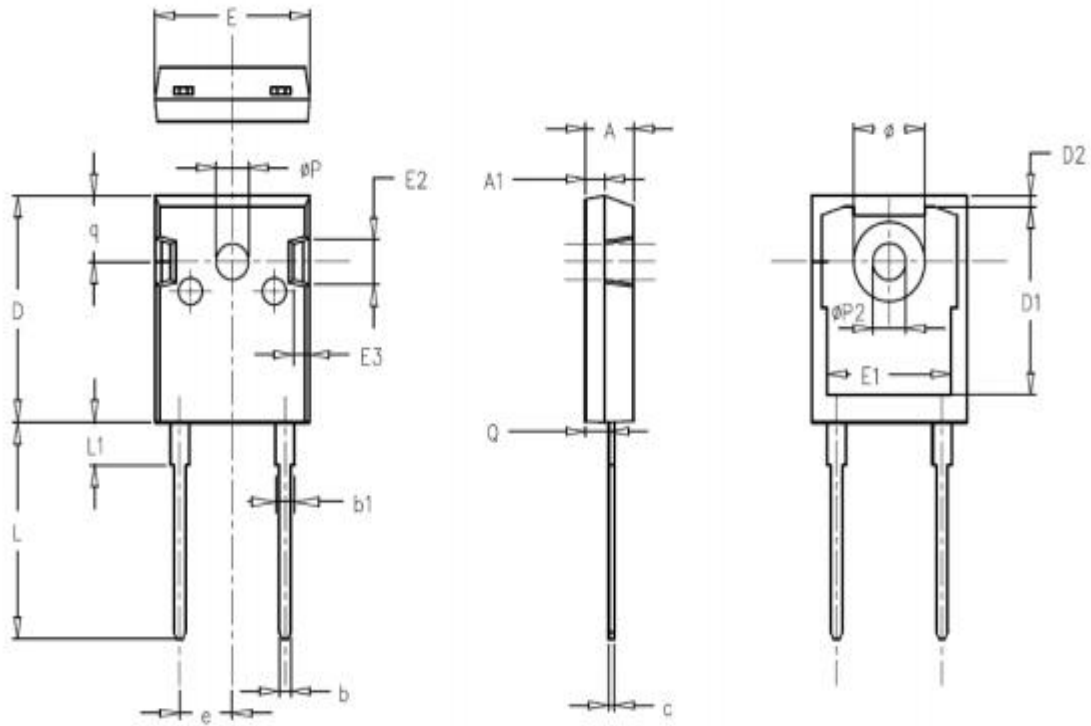

Figure 6. Transient Thermal Impedance

Package outline drawing(TO-247-2 Unit: mm)



SYMBOL	MILLIMETERS			NOTES	SYMBOL	MILLIMETERS			NOTES
	Normal	MIN.	MAX.			Normal	MIN.	MAX.	
A	4.98	4.68	5.36		ϕP	3.66	3.45	3.85	
A1	1.99	1.90	2.10		e	5.44	BSC		
Q	2.41	2.30	2.60		q	6.24	5.99	6.58	
c	0.60	0.48	0.72		$\phi P2$	3.45	3.24	3.64	
b	1.20	1.00	1.40		ϕ	7.14	7.10	7.30	
b1	2.07	1.90	2.30		D1	16.56	16.10	17.10	
D	21.10	20.80	21.80		D2	0.98	0.80	1.36	
E	15.98	15.38	16.20		E1	13.30	13.00	13.52	
L	20.28	19.50	20.50		E2	5.64	5.10	6.10	
L1	4.01	3.75	4.35		E3	2.33	1.90	2.70	

Disclaimers:

Reasunos Semiconductor Technology Co.Ltd (Reasunos) reserves the right to make changes without notice in order to improve reliability,function or design and to discontinue any product or service without notice .Customers should obtain the latest relevant information before orders and should verify that such information in current and complete.All products are sold subject to Reasunos's terms and conditions supplied at the time of orderacknowledgement.

Reasunos Semiconductor Technology Co.Ltd warrants performance of its hardware products to the specifications at the time of sale.Testing,reliability and quality control are used to the extene Reasunos deems necessary to support this warrantee. Except where agreed upon by contr- actual agreement,testing of all parameters of each product is not necessarily performed.

Reasunos Semiconductor Technology Co.Ltd does not assume any liability arising from the use of any product or circuit designs described herein.Customers are responsible for their products and applications using Reasunos's components.To minimize risk,customers must provide adequate design and operating safeguards.

Reasunos Semiconductor Technology Co.Ltd does not warrant or convey any license eith- er expressed or implied under its patent rights,nor the rights of others.Reproduction of inform- ation in Reasunos's data sheets or data books is permissible only if reproduction is without modification oralteration.Reproduction of this information with any alteration is an unfair and deceptive business practice. Reasunos Semiconductor Technology Co.Ltd is not responsi- ble or liable for such altered documentation.

Resale of Reasunos's products with statements different from or beyond the parameters stated by Reasunos Semiconductor Technology Co.Ltd for that product or service voids all exp- ress or implied warranties for the associated Reasunos's product or service and is unfair and deceptive business practice. Reasunos Semiconductor Technology Co.Ltd is not responsi- ble or liable for such statements.

Life Support Policy:

Reasunos Semiconductor Technology Co.Ltd's Products are not authorized for use as cri- tical components in life support devices or systems without the expressed written approval of Reasunos Semiconductor Technology Co.Ltd.

As used herein:

1. Life support devices or systems are devices or systems which: a.are intended for surgical implant into the human body, b.support or sustain life, c.whose failuer to when properly used in accordance with instructions for used provided in the laeling,can be reasonably expected to result in significant injury to the user.

2.A critical component is any component of a life support device or system whose failure to system whose failure to perform can be reasonably expected to cause the failure of the life support device or system,or to affect its safety or effectiveness.

X-ON Electronics

Largest Supplier of Electrical and Electronic Components

Click to view similar products for [Schottky Diodes & Rectifiers](#) category:

Click to view products by [REASUNOS](#) manufacturer:

Other Similar products are found below :

[MA4E2039](#) [MMBD301M3T5G](#) [RB160M-50TR](#) [D83C](#) [BAS16E6433HTMA1](#) [BAS 3010S-02LRH E6327](#) [BAT 54-02LRH E6327](#)
[NRVBAF360T3G](#) [NSR05F40QNXT5G](#) [NTE555](#) [JANS1N6640](#) [SS3003CH-TL-E](#) [GA01SHT18](#) [CRS10I30A\(TE85L,QM](#) [MBRA140TRPBF](#)
[MBRB30H30CT-1G](#) [BAT 15-04R E6152](#) [JANTX1N5712-1](#) [DMJ3940-000](#) [SB007-03C-TB-E](#) [NRVBB20100CTT4G](#) [NRVBM120LT1G](#)
[NTSB30U100CT-1G](#) [CRG04\(T5L,TEMQ\)](#) [ACDBA1100LR-HF](#) [ACDBA1200-HF](#) [ACDBA240-HF](#) [ACDBA3100-HF](#) [CDBQC0530L-HF](#)
[ACDBA260LR-HF](#) [ACDBA1100-HF](#) [10BQ015-M3/5BT](#) [NRVBM120ET1G](#) [VSSB410S-M3/5BT](#) [1N5819T-G](#) [PDS1040Q-13](#) [B160BQ-13-F](#)
[SDM05U20CSP-7](#) [BAS 70-07 E6433](#) [B140S1F-7](#) [HSM560Je3/TR13](#) [DDB2265-000](#) [ZHCS506QTA](#) [HSM190Je3/TR13](#) [B330AF-13](#)
[ACDBUC0230-HF](#) [SDM1U100S1F-7](#) [MBR10200CTF-G1](#) [CDLL5712](#) [DMF2822-000](#)