

Features

Regulated Converter

- High output voltage DIP24 converter
- Adjustable output voltage up to 200VDC
- Cascadable for output voltages up to 400VDC
- 3kVDC input/output isolation
- Remote voltage programming by external voltage or resistance
- Continuous short circuit protection
- Ambient temperature up to +85°C



Rxx-B

5 Watt
DIP24
Single Output

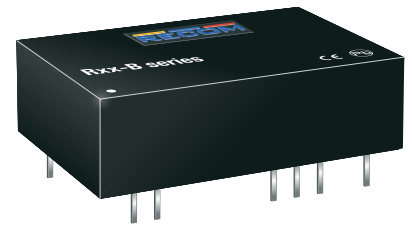

EN60950-1 certified
IEC60950-1 certified

Description

The Rxx-B series are 5W regulated high output voltage isolated DC/DC converters in a DIP24 package. Three adjustable output voltages of 87V (41-120V), 103V (50-135V) or 159V (92-200V) are offered, with nominal input voltage options of 5V, 12V, 15V or 24V. The modules can be cascaded for higher output voltages up to 400VDC. The output is isolated from the input with 3kVDC isolation and the modules can be operated over a -40°C to +85°C ambient temperature range. The Rxx-B series is safety certified with IEC/EN60950-1 certifications (the R24-100B has additionally UL/IEC/EN62368 with CB Report). A three year warranty is offered.

Selection Guide

Part Number	Input Voltage Range [VDC]	nom. Output Voltage [VDC]	Output Voltage Range [VDC]	Output Power max. ⁽¹⁾ [W]	Efficiency typ. ⁽²⁾ [%]	Max. Capacitive Load ⁽³⁾ [µF]
R05-100B	4.5 - 6	87	+41...+120	3	77	20
R12-100B	10 - 14	103	+50...+135	5	82	30
R15-100B	14 - 17	103	+59...+130	5	82	30
R24-100B	21 - 27	105	+56...+135	5	84	30
R12-150B	10 - 14	159	+92...+200	5	82	40
R15-150B	14 - 17	159	+92...+200	5	82	40
R24-150B	21 - 27	159	+92...+200	5	84	40

Notes:

- Note1: Refer to „Power Limit“ graph
 Note2: Efficiency is tested at nominal input and full load at +25°C ambient
 Note3: Max. Cap Load is tested at nominal input and full resistive load.
 If the load is mainly capacitive, it should have a minimum resistive load of 10mA

Model Numbering

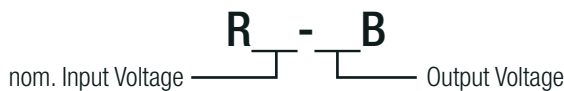

Specifications (measured @ Ta= 25°C, nom. Vin and full load)

BASIC CHARACTERISTICS

Parameter	Condition	Min.	Typ.	Max.
Input Voltage Range	nom. Vin= 5VDC	4.5VDC	5VDC	6VDC
	nom. Vin= 12VDC	10VDC	12VDC	14VDC
	nom. Vin= 15VDC	14VDC	15VDC	17VDC
	nom. Vin= 24VDC	21VDC	24VDC	27VDC
Output Current	refer to „Power Limit“			50mA
Output Power	5V			3W
	all others			5W
Output Voltage Adjust	External Voltage	0VDC		4VDC
	External Resistor	0kΩ		5kΩ
Internal Voltage Reference	refer to page I-4 to I-5	regulated 5VDC with 1kΩ series resistor		
Internal Operating Frequency			200kHz	
Output Ripple and Noise	20MHz BW		60mVp-p	100mVp-p

Efficiency vs. Output Voltage

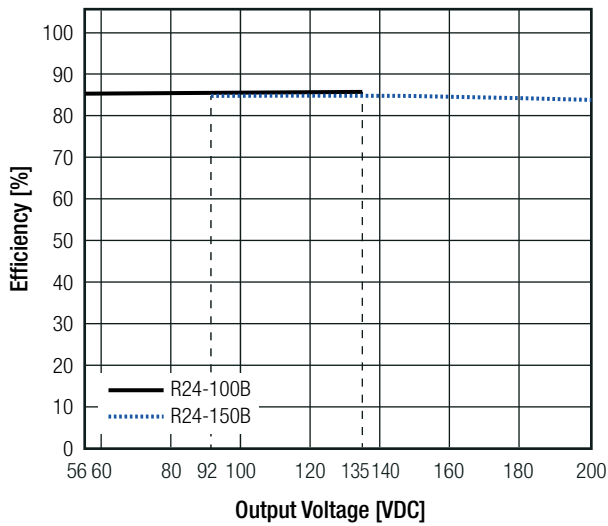

Output Ripple vs. Output Voltage

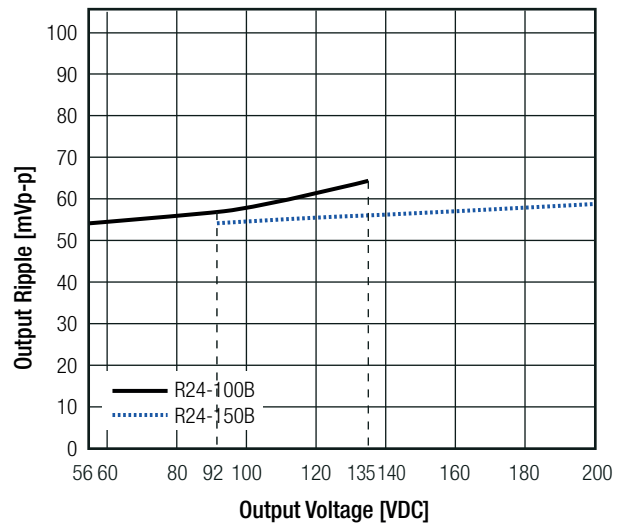

Power Limit

R12-150B; R15-150B; R24-150

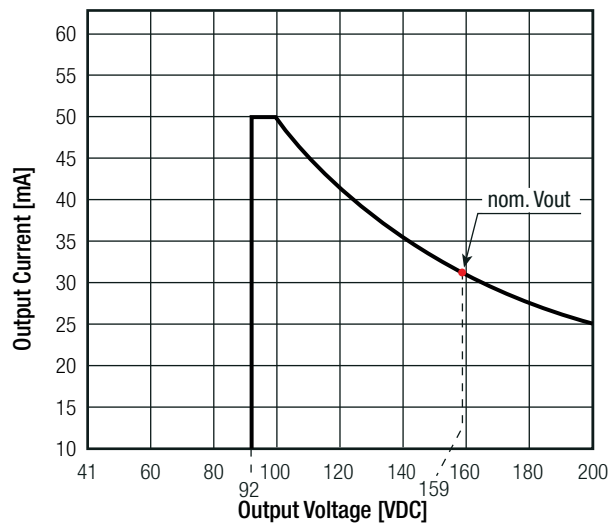

continued on next page

Specifications (measured @ Ta= 25°C, nom. Vin and full load)

Power Limit

R05-100B

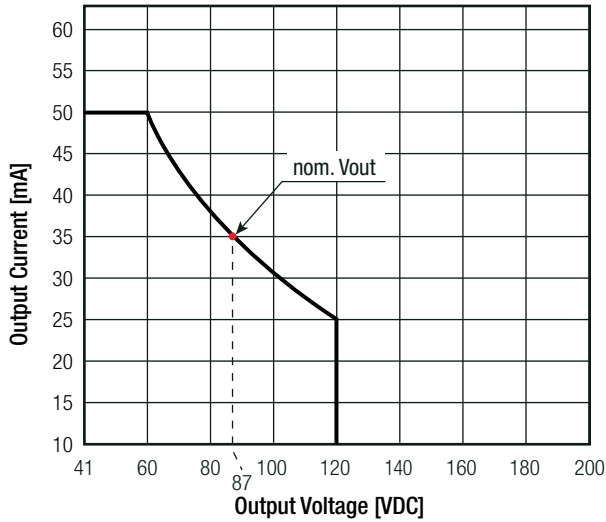

R12-100B

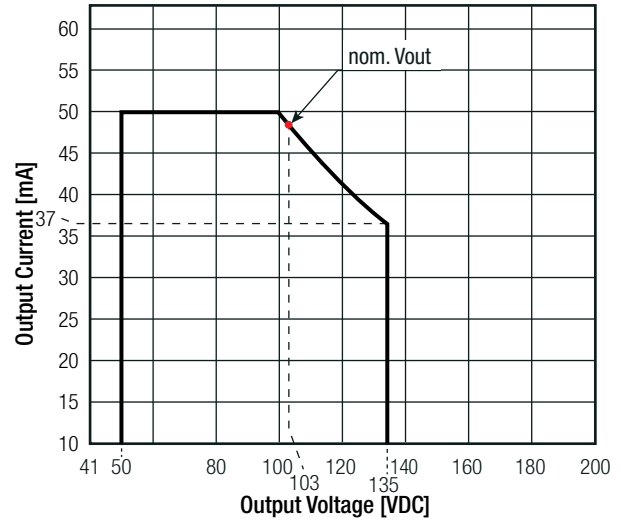

R15-100B

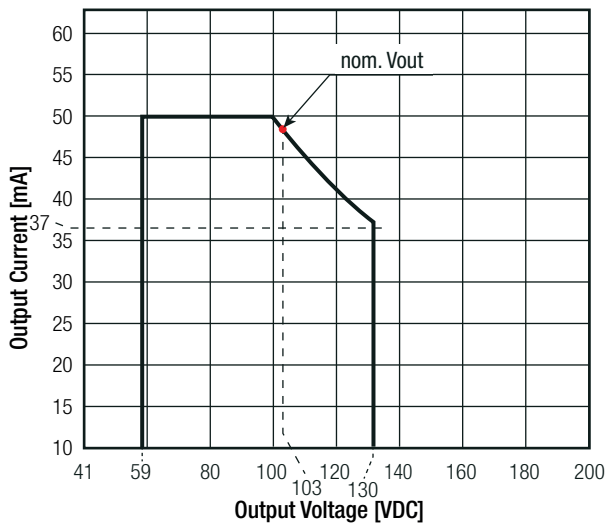

R24-100B

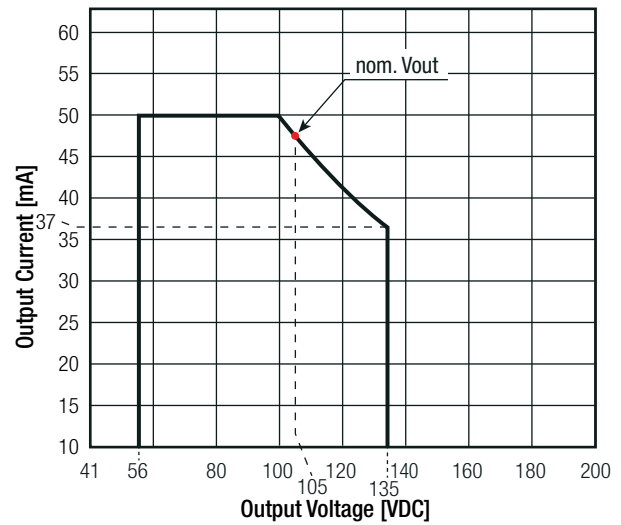

REGULATIONS

Parameter	Condition	Value
Output Accuracy		±5.0% max.
Line Regulation	low line to high line	±0.5% max.
Load Regulation	20% to 100% load	0.5% max.

PROTECTIONS

Parameter	Condition	Value
Short Circuit Protection (SCP)		continuous, automatic restart
Isolation Voltage	tested for 1 second	3kVDC min.
Isolation Resistance		1GΩ min.
Isolation Capacitance		20pF typ.

Specifications (measured @ Ta= 25°C, nom. Vin and full load)

ENVIRONMENTAL

Parameter	Condition	Value
Operating Temperature Range	with derating @ free air convection (see graph)	-40°C to +85°C
	full load @ free air convection (see graph)	-40°C to +70°C
Temperature Coefficient		± 0.02%/K
Operating Altitude		2000m
Operating Humidity	non-condensing	95% RH max.
Pollution Degree		PD2
MTBF	according to MIL-HDBK-217F, G.B. +25°C	1400 x 10 ³ hours

Derating Graph
(@ free air convection)

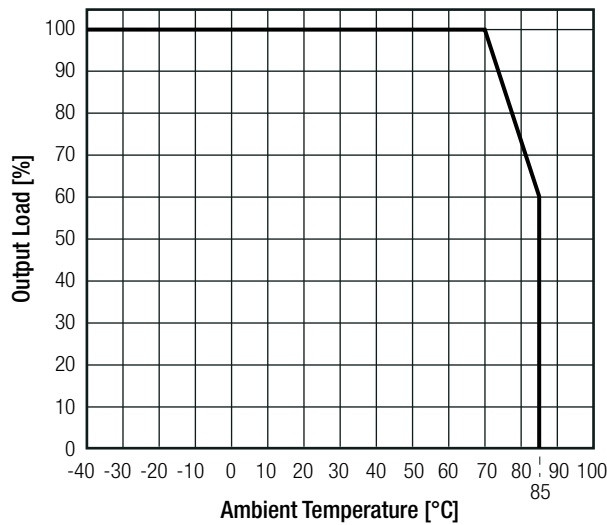

SAFETY AND CERTIFICATIONS

Certificate Type (Safety)	Report / File Number	Standard
Information Technology Equipment, General Requirements for Safety	SPCLVD1605077-02	IEC60950-1:2005, 2nd Edition + AM 2:2013 EN60950-1:2006 + AM 2:2013
EAC	RU-AT.49.09571	TP TC 004/2011
RoHS2+		RoHS-2001/65/EU + AM-2015/863

DIMENSION AND PHYSICAL CHARACTERISTICS

Parameter	Type	Value
Material	case	non conductive black plastic, (UL94 V-0)
	potting	epoxy, (UL94 V-0)
	PCB	FR4, (UL94 V-0)
Package Dimension (LxWxH)		31.2 x 20.3 x 9.4mm
Package Weight		12g typ.

continued on next page

Specifications (measured @ Ta= 25°C, nom. Vin and full load)

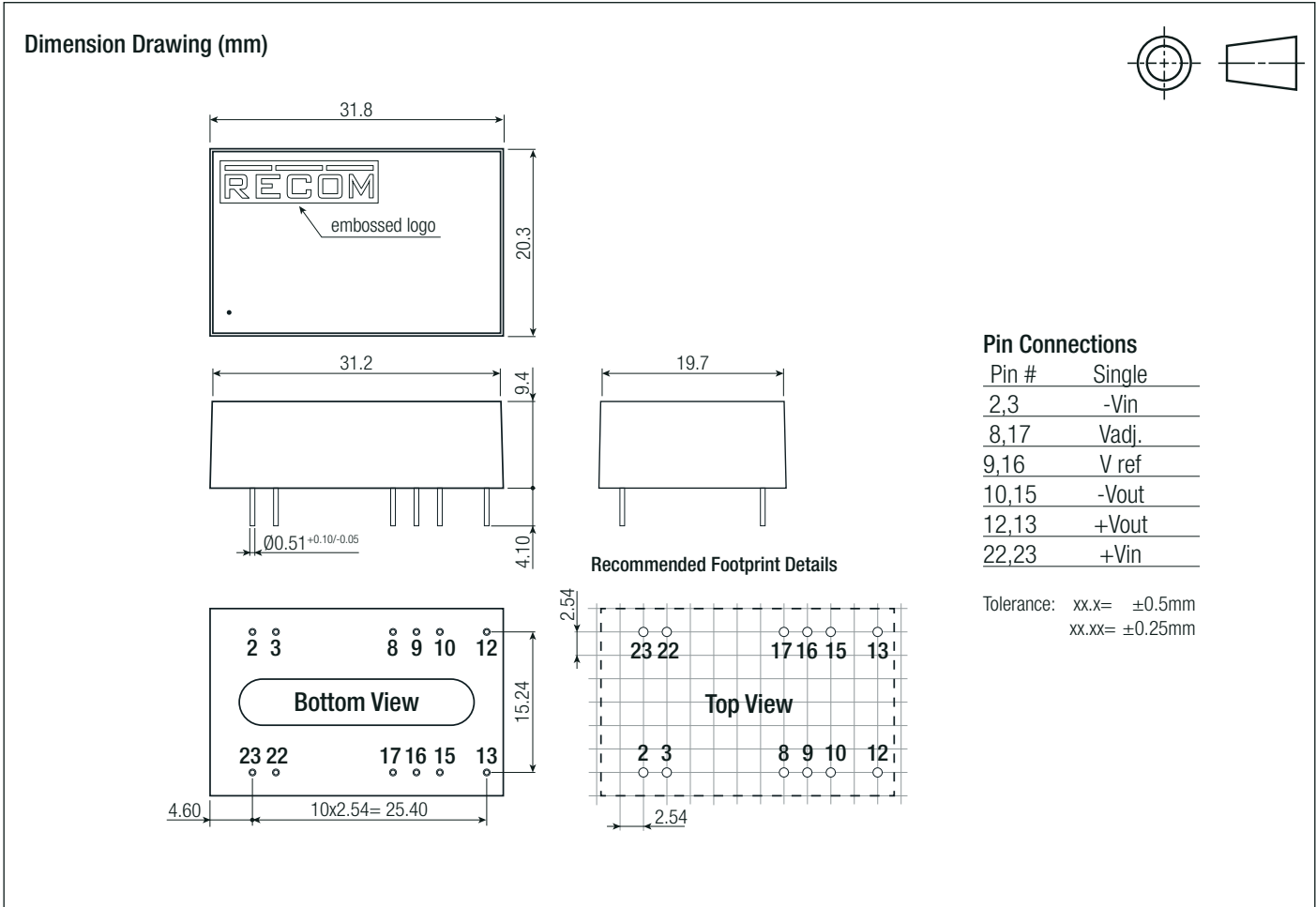

INSTALLATION AND APPLICATION

Output Voltage Adjust

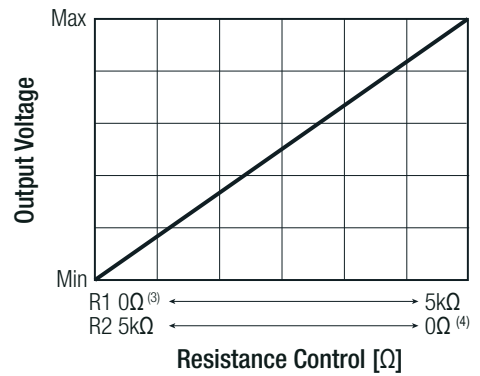
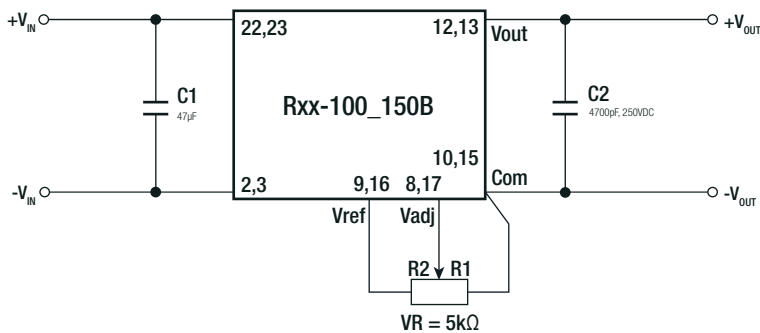

Notes:

- Note3: 0Ω means Vadj connected to COM; no connection to Vref
- Note4: 0Ω means Vadj connected to Vref; no connection to COM

continued on next page

Specifications (measured @ Ta= 25°C, nom. Vin and full load)

For Remote Voltage Control

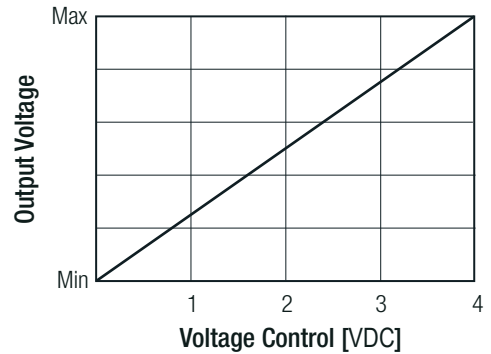
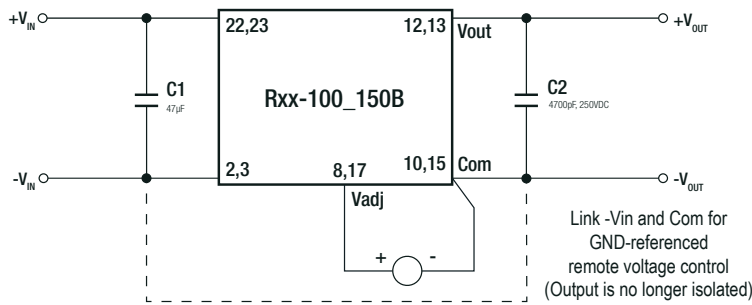

Cascade Circuit

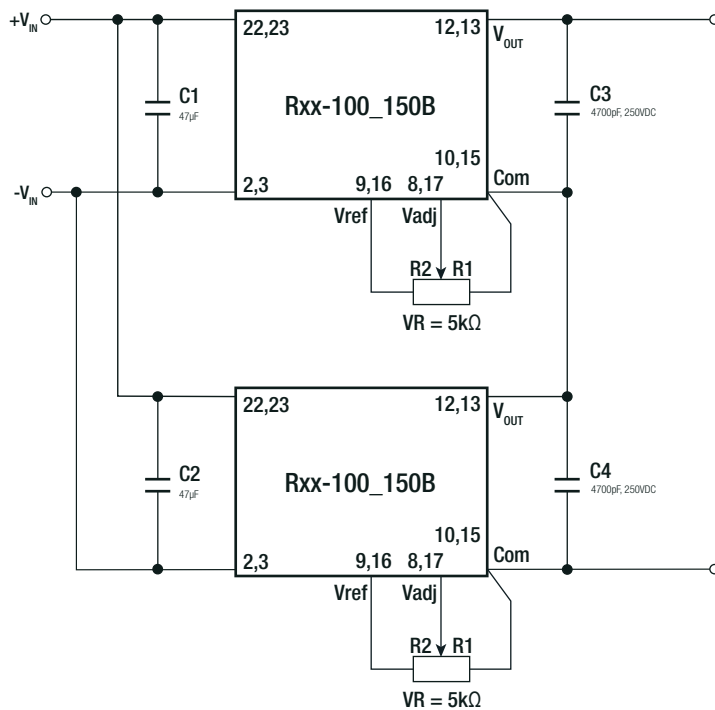

Cascade Combinations

U1	U2	Vout Range
R05-100B	R05-100B	160-240
Rxx-100B	Rxx-100B	190~260
Rxx-150B	Rxx-100B	230~330
Rxx-150B	Rxx-150B	305~400

xx = 12, 15 or 24

Note: When cascaded, only one Rxx-B may be adjustable, the other must be fixed voltage.

PACKAGING INFORMATION

Parameter	Type	Value
Packaging Dimension (LxWxH)	tube	530.0 x 23.0 x 19.0mm
Packaging Quantity	tube	6pcs
Storage Temperature Range		- 50°C to +125°C
Storage Humidity		95% RH max.

The product information and specifications may be subject to changes even without prior written notice. The product has been designed for various applications; its suitability lies in the responsibility of each customer. The products are not authorized for use in safety-critical applications without RECOM's explicit written consent. A safety-critical application is an application where a failure may reasonably be expected to endanger or cause loss of life, inflict bodily harm or damage property. The applicant shall indemnify and hold harmless RECOM, its affiliated companies and its representatives against any damage claims in connection with the unauthorized use of RECOM products in such safety-critical applications.

X-ON Electronics

Largest Supplier of Electrical and Electronic Components

Click to view similar products for [Isolated DC/DC Converters](#) category:

Click to view products by [RECOM POWER](#) manufacturer:

Other Similar products are found below :

[ESM6D044440C05AAQ](#) [FMD15.24G](#) [PSL486-7LR](#) [Q48T30020-NBB0](#) [JAHW100Y1](#) [SPB05C-12](#) [SQ24S15033-PS0S](#) [18952](#) [19-130041](#)
[CE-1003](#) [CE-1004](#) [GQ2541-7R](#) [RDS180245](#) [MAU228](#) [J80-0041NL](#) [DFC15U48D15](#) [XGS-0512](#) [XGS-1205](#) [XGS-1212](#) [XGS-2412](#) [XGS-2415](#) [XKS-1215](#) [06322](#) [NCT1000N040R050B](#) [SPB05B-15](#) [SPB05C-15](#) [L-DA20](#) [DCG40-5G](#) [QME48T40033-PGB0](#) [XKS-2415](#) [XKS-2412](#)
[XKS-1212](#) [XKS-1205](#) [XKS-0515](#) [XKS-0505](#) [XGS-2405](#) [XGS-1215](#) [XGS-0515](#) [PS9Z-6RM4](#) [73-551-5038I](#) [AK1601-9RT](#) [VI-N61-CM](#) [VI-R5022-EXWW](#) [PSC128-7iR](#) [RPS8-350ATX-XE](#) [DAS1004812](#) [PQA30-D24-S24-DH](#) [VI-M5F-CQ](#) [VI-LN2-EW](#) [VI-PJW01-CZY](#)