

Features

Switching Regulator

- Efficiency up to 97%, no heatsinks required
- Pin compatible with LM78XX linears
- Low profile (L/W/H=11.5 x 8.5 x 17.5mm)
- Wide input range
- Short circuit protection, thermal shutdown
- Low ripple and noise
- „L“ version with 90° pins
- Positive to negative converter

RECOM DC/DC Converter

R-78B-1.0(L)

1.0 Amp
SIP3
Single Output



Description

The R-78Bxx-1.0 series high efficiency switching regulators are ideally suited to replace 78xx linear regulators and are pin compatible. The efficiency of up to 97% means that very little energy is wasted as heat so there is no need for any heat sinks with their additional space and mounting costs. The L-Version with 90° pins allows direct replacement for laid-flat regulators where component height is at a premium. Low ripple and noise figures and a short circuit input current of typically only 10mA round off the specifications of this versatile converter series.

Selection Guide

Part Number	Input Voltage Range [VDC]	Output Voltage [VDC]	Output Current [A]	Efficiency	
				@ min Vin [%]	@ max. Vin [%]
R-78B1.5-1.0 ⁽¹⁾	4.75 - 26	1.5	1.0	77	71
R-78B1.8-1.0 ⁽¹⁾	4.75 - 26	1.8	1.0	80	74
R-78B2.5-1.0 ⁽¹⁾	4.75 - 32	2.5	1.0	85	78
R-78B3.3-1.0 ⁽¹⁾	4.75 - 32	3.3	1.0	89	83
R-78B5.0-1.0 ⁽¹⁾	6.5 - 32	5.0	1.0	93	88
R-78B6.5-1.0 ⁽¹⁾	9.0 - 32	6.5	1.0	94	90
R-78B9.0-1.0 ⁽¹⁾	12 - 32	9.0	1.0	95	93
R-78B12-1.0 ⁽¹⁾	16 - 32	12	1.0	96	95
R-78B15-1.0 ⁽¹⁾	20 - 32	15	1.0	97	96

Model Numbering

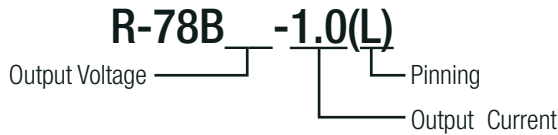

Notes:

Note1: add suffix "L" for 90° bent pins, e.g. R-78B5.0-1.0L

Specifications (measured @ Ta= 25°C, 10% minimum load, unless otherwise stated)

BASIC CHARACTERISTICS					
Parameter	Condition		Min.	Typ.	Max.
Absolute Maximum Input Voltage	1.5Vout , 1.8Vout 2.5Vout to 15Vout				26VDC 34VDC
Quiescent Current	nom. Vin= 24VDC			5mA	7mA
Internal Power Dissipation	Vout= 1.5VDC				0.65W
Internal Operating Frequency	nom. Vin= 24VDC		280kHz	330kHz	380kHz
Minimum Load ⁽²⁾			0%		
Output Ripple and Noise ⁽³⁾	20MHz BW	1.5Vout to 6.5Vout 9Vout to 15Vout		15mVp-p 25mVp-p	20mVp-p 35mVp-p
Ref. Back Ripple Current				150mA	200mA-p-p
Absolute Maximum Capacitive Load	1 second start up, no external components <1 second start up + diode protection circuit				470µF 6800µF

Notes:

Note2: Operation under no load will not harm the converter, but specifications may not be met
A minimum load of 10mA is recommended

Note3: Output Ripple and Noise is tested from 10% to 100% load

continued on next page

EN55032 compliant
IEC/EN60950-1 certified

Specifications (measured @ Ta= 25°C, 10% minimum load, unless otherwise stated)

Efficiency vs. Vin (full load)

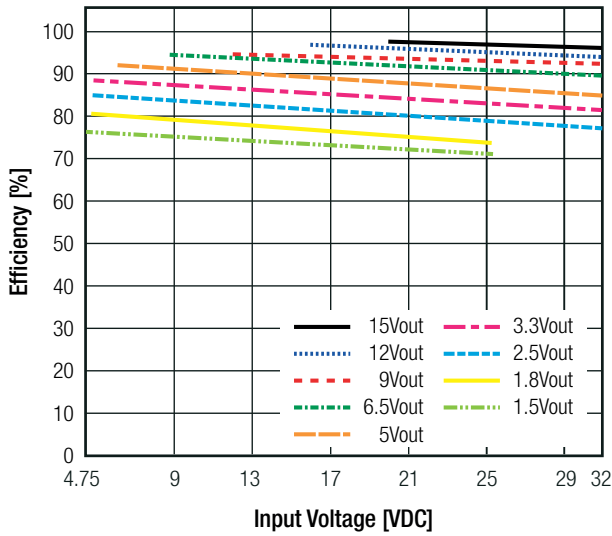

Ripple vs. Vin (full load)

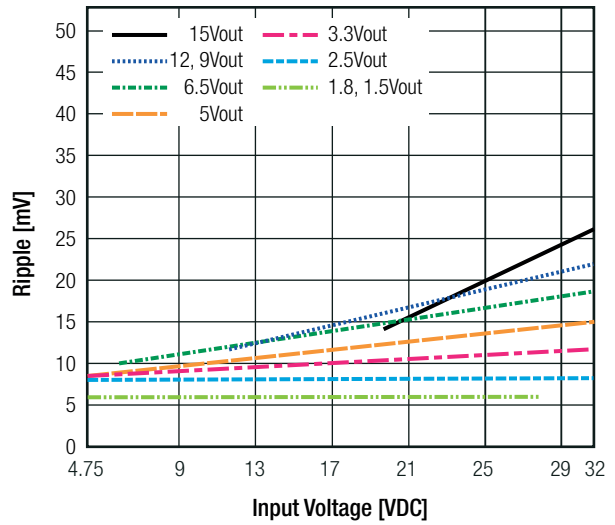

Efficiency vs. Load (max. Vin)

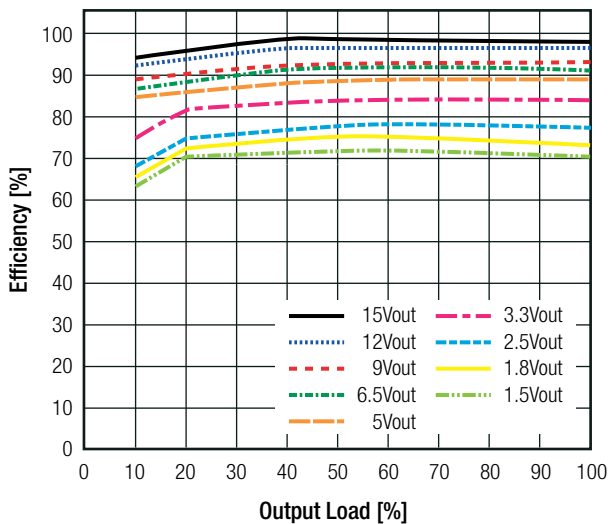

Ripple vs. Load (max. Vin)

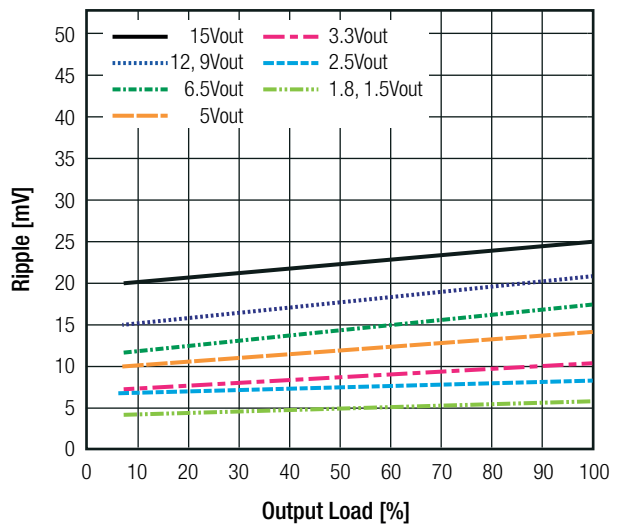

Efficiency vs. Load (min. Vin)

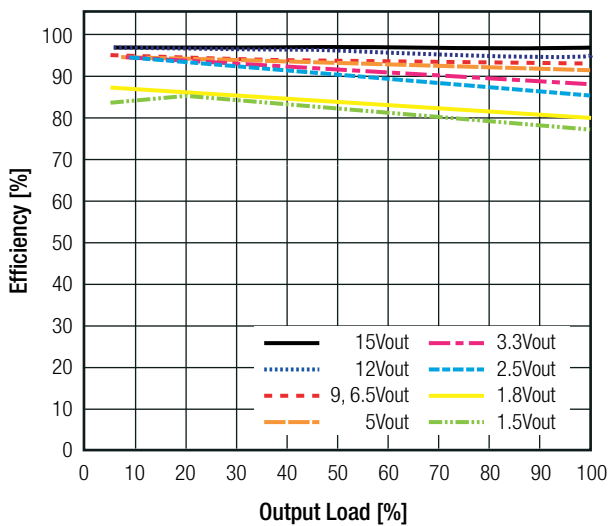

Ripple vs. Load (min. Vin)

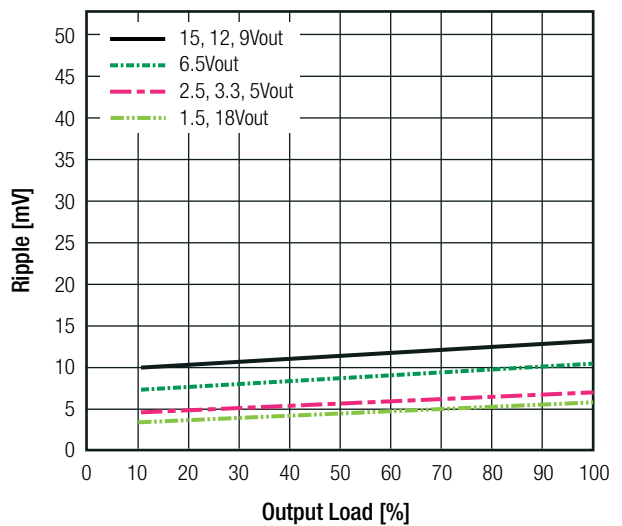

Specifications (measured @ Ta= 25°C, 10% minimum load, unless otherwise stated)

REGULATIONS

Parameter	Condition		Value
Output Accuracy	100% load		±2.0% typ / ±3.0% max.
Line Regulation	low line to high line, 100% load	1.5Vout to 6.5Vout	±0.2% typ. / ±0.4% max.
		9Vout to 15Vout	±0.1% typ. / ±0.2% max.
Load Regulation	10% to 100% load	1.5Vout to 6.5Vout	±0.4% typ. / ±0.6% max.
		9Vout to 15Vout	±0.25% typ. / ±0.4% max.
Transient Response	100% <-> 50% load		±100mV typ. / ±150mV max.
	Recovery Time		1.0ms typ. / 1.5ms max.

PROTECTIONS

Parameter	Condition	Value
Short Circuit Protection (SCP)	below 100mΩ	continuous, automatic recovery
Short Circuit Input Current	nom. Vin= 24VDC	60mA max.

Optional Diode Protection Circuit

Add a blocking diode to Vout if current can flow backwards into the output, as this can damage the converter when it is powered down.

The diode can either be fitted across the device if the source is low impedance or fitted in series with the output (recommended).

Optional Protection 1:

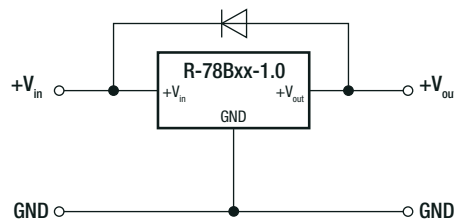

Optional Protection 2:

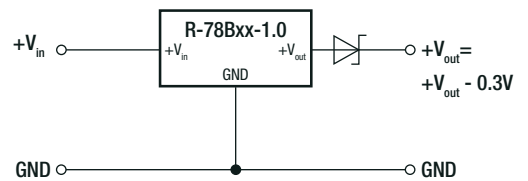

Protection Circuit

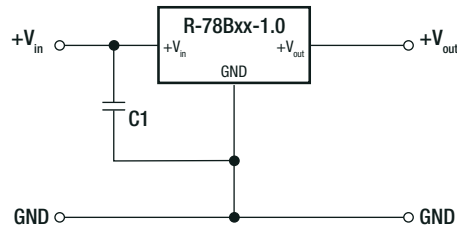

To protect the converter during power-up, use C1=22µF if Vin>30V

ENVIRONMENTAL

Parameter	Condition		Value
Operating Temperature Range	with derating (see graph)		-40°C to +85°C
Maximum Case Temperature			+100°C
Temperature Coefficient			±0.015%/K
Thermal Impedance	0.1m/s, vertical		60K/W
Operating Altitude			2000m
Operating Humidity	non-condensing		95% RH max.
Pollution Degree			PD2
MTBF	according to MIL-HDBK-217F, G.B.	+25°C	8593 x 10 ³ hours

continued on next page

Specifications (measured @ Ta= 25°C, 10% minimum load, unless otherwise stated)

Derating Graph

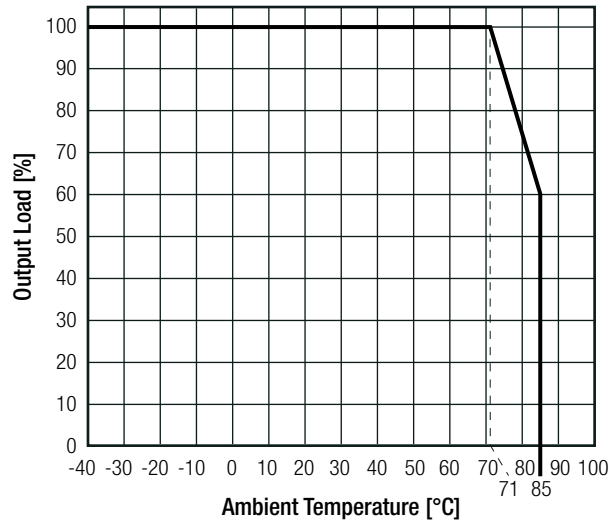

SAFETY AND CERTIFICATIONS

Certificate Type (Safety)	Report / File Number	Standard
Information Technology Equipment, General Requirements for Safety	1603123	IEC60950-1:2005, 2nd Edition + AM 2:2013 EN60950-1:2006 + AM 2:2013
EAC	RU-AT.49.09571	TP TC 004/2011
RoHS 2+		RoHS 2011/65/EU + AM2015/863

EMC Compliance	Condition	Standard / Criterion
Electromagnetic compatibility of multimedia equipment - Emission requirements	with external filter (see filter suggestion below)	EN55032, Class A and B
ESD Electrostatic discharge immunity test	Air ±8kV, Contact ±4kV	EN61000-4-2, Criteria A
Radiated, radio-frequency, electromagnetic field immunity test	3V/m	EN61000-4-3, Criteria A

EMC Filter Suggestion according to EN55032

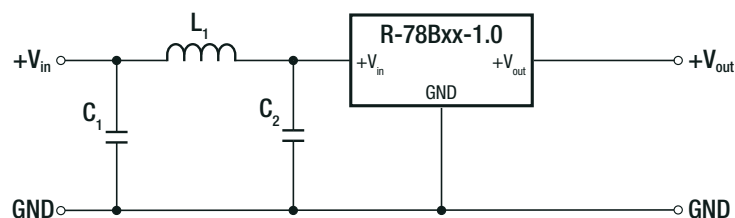

Component List Class A

MODEL	C1	C2	L1
R-78B5.0-1.0(L)	10µF 100V MLCC	4.7µF 50V MLCC	3.9µH choke RLS-397
R-78B12-1.0(L)			
R-78B15-1.0(L)			

Component List Class B

MODEL	C1	C2	L1
R-78B5.0-1.0(L)	10µF 100V MLCC	10µF 100V MLCC	12µH choke RLS-126
R-78B12-1.0(L)			
R-78B15-1.0(L)			

Notes:

Note4: Filter suggestions are valid for indicated part numbers only. For other part numbers, please contact RECOM tech support for advice

Specifications (measured @ Ta= 25°C, 10% minimum load, unless otherwise stated)

DIMENSION AND PHYSICAL CHARACTERISTICS

Parameter	Type	Value
Material	case potting	non-conductive black plastic, (UL94 V-0) silicone, (UL94 V-0)
Package Dimension (LxWxH)		11.5 x 8.5 x 17.5mm
Package Weight		4g typ.

Dimension Drawing (mm)

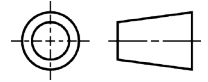
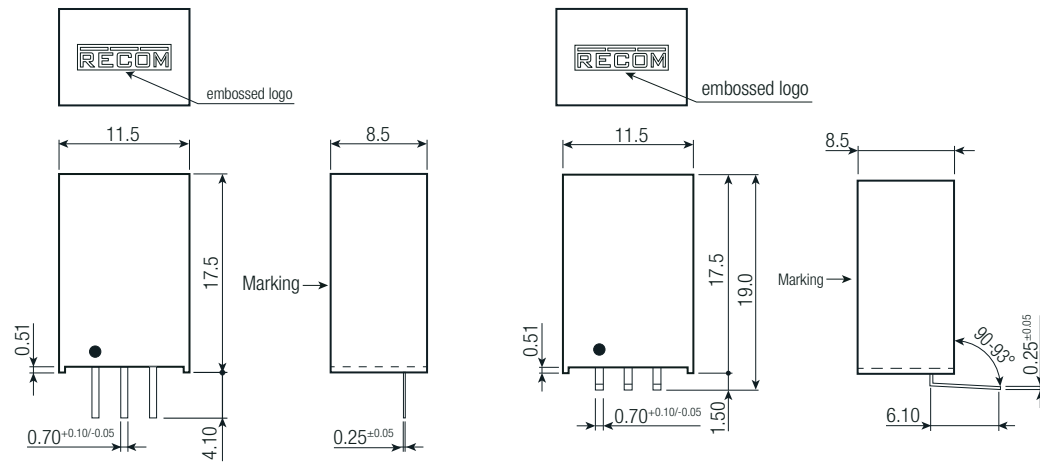

Pin Connections

Pin #	Single
1	+Vin
2	GND
3	+Vout

Tolerance: xx.x= ±0.5mm
xx.xx= ±0.25mm

Recommended Footprint Details

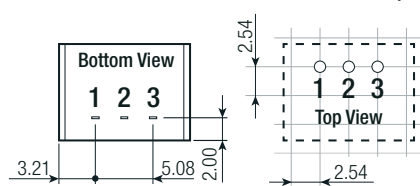

Recommended Footprint Details

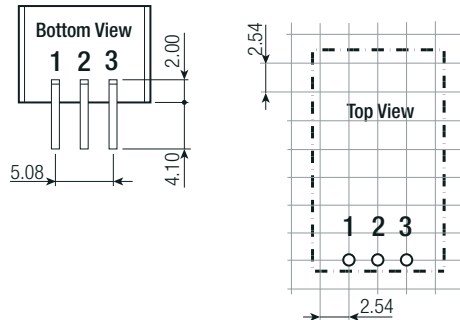

INSTALLATION AND APPLICATION

Positive to Negative Converter

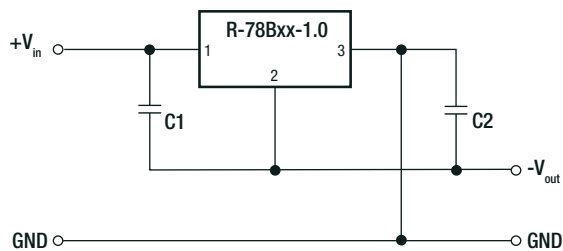

C1 and C2 are required and should be fitted close to the converter pins.

Maximum capacitive load including C2 is 220µF

Pin Connections

Pin #	Negative	Positive
1	+Vin	+Vin
2	-Vout	GND
3	GND	+Vout

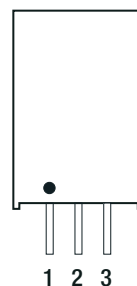

continued on next page

Specifications (measured @ Ta= 25°C, 10% minimum load, unless otherwise stated)

Selection Guide - Negative Output

Part Number	Input Voltage Range [VDC]	Output Voltage [VDC]	Output Current [A]	Efficiency		External Capacitor	
				@ min Vin [%]	@ max. Vin [%]	C1	C2 ⁽⁵⁾
R-78B1.5-1.0	4.75 - 28	-1.5	-0.6	70	68	10µF/50V	22µF/6.3V
R-78B1.8-1.0	4.75 - 28	-1.8	-0.6	72	72	10µF/50V	22µF/6.3V
R-78B2.5-1.0	4.75 - 28	-2.5	-0.6	75	77	10µF/50V	22µF/6.3V
R-78B3.3-1.0	4.75 - 28	-3.3	-0.6	77	80	10µF/50V	22µF/6.3V
R-78B5.0-1.0	6.5 - 28	-5.0	-0.6	83	85	10µF/50V	22µF/10V
R-78B6.5-1.0	8.0 - 26	-6.5	-0.4	84	87	10µF/50V	10µF/10V
R-78B9.0-1.0	8.0 - 18	-9.0	-0.4	88	89	10µF/25V	10µF/25V
R-78B12-1.0	8.0 - 18	-12	-0.3	89	90	10µF/25V	10µF/25V
R-78B15-1.0	8.0 - 18	-15	-0.3	89	91	10µF/25V	10µF/25V

Notes:

Note5: Maximum Capacitive Load including C2 is 220µF

Dual Output (two Converters) with Negative Output

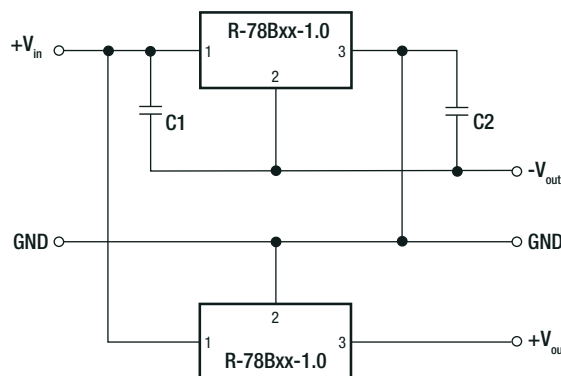

Application Examples

High Efficiency Multiple Output

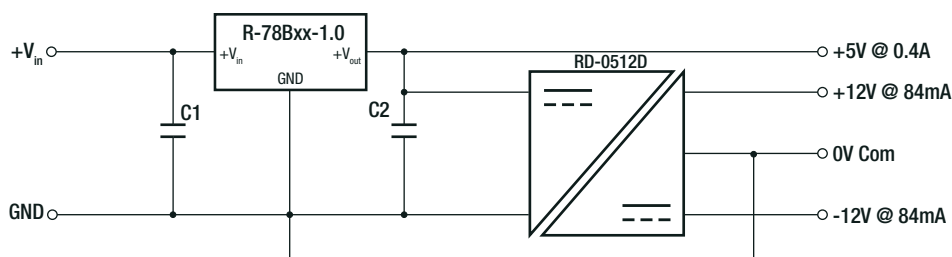

C1 optional;
C2 required (further decoupling filtering may be necessary between the two converters)

- Wide input range 4.75V to 34V
- ±12V outputs for analogue circuits, e.g. instrumentation amplifier
- +5V output for digital circuits

continued on next page

Specifications (measured @ Ta= 25°C, 10% minimum load, unless otherwise stated)

Isolated, Wide Input Range, Distributed Power Architecture (Point-of-Load)

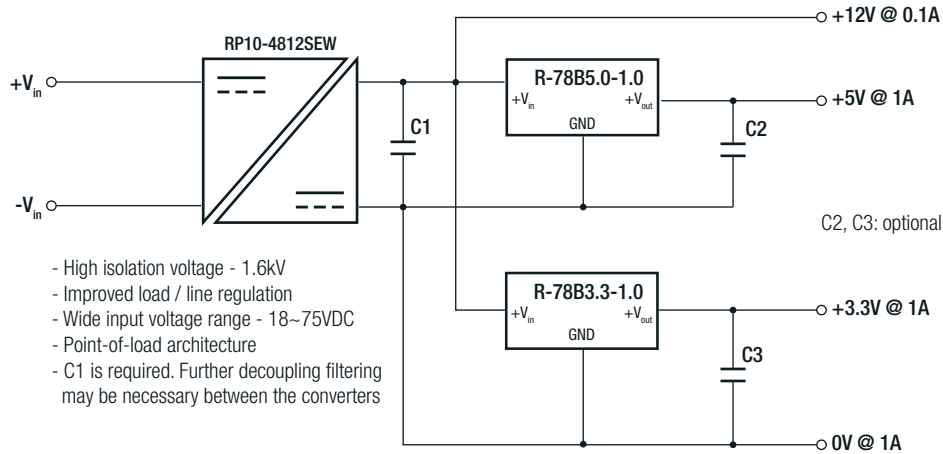

PACKAGING INFORMATION

Parameter	Type		Value
	tube	without suffix with suffix "L"	
Packaging Dimension (LxWxH)			520.0 x 25.1 x 10.6mm 520.0 x 26.1 x 15.8mm
Packaging Quantity	tube		42pcs
Storage Temperature Range			-55°C to +125°C
Storage Humidity			95% RH max.

The product information and specifications may be subject to changes even without prior written notice. The product has been designed for various applications; its suitability lies in the responsibility of each customer. The products are not authorized for use in safety-critical applications without RECOM's explicit written consent. A safety-critical application is an application where a failure may reasonably be expected to endanger or cause loss of life, inflict bodily harm or damage property. The applicant shall indemnify and hold harmless RECOM, its affiliated companies and its representatives against any damage claims in connection with the unauthorized use of RECOM products in such safety-critical applications.

X-ON Electronics

Largest Supplier of Electrical and Electronic Components

Click to view similar products for [Non-Isolated DC/DC Converters](#) category:

Click to view products by [Recom Power](#) manufacturer:

Other Similar products are found below :

[PSR152.5-7IR](#) [APTH003A0X-SRZ](#) [SPM1004-3V3C](#) [R-785.0-05](#) [10E24-P15-10PPM](#) [1E24-P4-25PPM-SHV-5KV](#) [PROPOWER-3.3V](#)
[MYGTM01210BZN](#) [40C24-N250-I5-H](#) [40A24-P30-E](#) [3V12-P0.8](#) [10C24-N250-I10-AQ-DA](#) [4AA24-P20-M-H](#) [3V12-N0.8](#) [3V24-P1](#) [3V24-](#)
[N1](#) [BMR4672010/001](#) [BMR4652010/001](#) [6AA24-P30-I5-M](#) [6AA24-N30-I5-M](#) [BM2P101X-Z](#) [35A24-P30](#) [2.5M24-P1](#) [PTV03010WAD](#)
[PTV05020WAH](#) [PTV12010LAH](#) [PTV12020WAD](#) [R-7212D](#) [R-7212P](#) [R-78AA15-0.5SMD](#) [R-78AA5.0-1.0SMD](#) [30A24-N15-E](#) [10A12-P4-](#)
[M](#) [10C24-N250-I5](#) [10C24-P125](#) [10C24-P250-I5](#) [6A24-P20-I10-F-M-25PPM](#) [1A24-P30-F-M-C](#) [TSR 1-24150SM](#) [1/2AA24-N30-I10](#) [1C24-](#)
[N125](#) [12C24-N250](#) [V7806-1500](#) [PTV12020LAH](#) [PTV05010WAH](#) [PTN04050CAZT](#) [PTH12020WAD](#) [PTH12020LAS](#) [PTH05050YAH](#)
[PTH05T210WAH](#)