

!NOT RECOMMENDED FOR NEW DESIGNS!

LAST TIME BUY: 30th OCT 2020, 3.3SC, 09SC, 15SC, 05DC, 12DC
 LAST TIME BUY: 27th NOV 2020, WIRED VERSION



RAC06-C

**6 Watt
Single &
Dual Output**



UL60950-1 certified
 CAN/CSA-C22.2 No. 60950-1 certified
 IEC/EN60950-1 certified
 EN55032 compliant
 EN55024 compliant

Features

- Very compact AC-DC power supply
- 6 Watt PCB mount package
- Universal input voltage range
- Class II power supply with 3kVAC/1 minute isolation
- Low output ripple and noise
- Short circuit protection
- Low standby power consumption
- UL certified, CE and EAC marked

Regulated Converters

Description

Compact, low cost, high efficiency, universal input switching AC/DC power module for PCB or wired mounting with single or dual outputs. CE/EAC marked and UL/cUL certified.

Selection Guide

Part Number	Input Voltage Range [VAC]	Output Voltage [VDC]	Output Current [mA]	Efficiency typ ⁽¹⁾ [%]	Max. Capacitive Load ^(2,3) [µF]
RAC06-05SC ⁽⁴⁾	80-264	5	1200	75	6800
RAC06-12SC ⁽⁴⁾	80-264	12	500	78	1500
RAC06-24SC ⁽⁴⁾	80-264	24	250	79	330
RAC06-15DC ⁽⁴⁾	80-264	±15	±200	79	±220

Notes:

- Note1: Efficiency is tested at nominal input and full load at +25°C ambient
 Note2: Measured @ 230VAC / 50Hz / Ta=25°C with constant resistant mode at full load
 Note3: If used @ 115VAC / 60Hz with full load, max. capacitive load is less, please contact RECOM Techsupport for detailed information

NRND (Last time buy: 30th Oct 2020)

Part Number	Input Voltage Range [VAC]	Output Voltage [VDC]	Output Current [mA]	Efficiency typ ⁽¹⁾ [%]	Max. Capacitive Load ^(2,3) [µF]
RAC06-3.3SC ⁽⁴⁾	80-264	3.3	1500	70	12000
RAC06-09SC ⁽⁴⁾	80-264	9	667	77	2500
RAC06-15SC ⁽⁴⁾	80-264	15	400	79	750
RAC06-05DC ⁽⁴⁾	80-264	±5	±600	75	±3000
RAC06-12DC ⁽⁴⁾	80-264	±12	±250	78	±680

Model Numbering

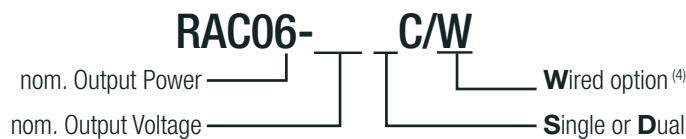

Notes:

- Note4: add suffix „W“ for wired version
 without suffix, standard THT version

Ordering Examples:

RAC06-05SC	6 Watt	5Vout	Single Output	THT version
RAC06-05SC/W	6 Watt	5Vout	Single Output	wired version
RAC06-12DC	6 Watt	12Vout	Dual Output	THT version
RAC06-12DC/W	6 Watt	12Vout	Dual Output	wired version

PREFERRED ALTERNATIVES

Please consider these alternatives:

RAC10-K/277 Series

RAC20-K/W Series

Specifications (measured at Ta= 25°C, full load otherwise noted)

BASIC CHARACTERISTICS

Parameter	Condition	Min.	Typ.	Max.
Input Voltage Range ⁽⁵⁾	nom. Vin = 230VAC	80VAC 115VDC		264VAC 370VDC
Input Current	115VAC 230VAC		120mA 78mA	
Inrush Current	<2ms 115VAC 230VAC			30A 60A
No load Power Consumption				250mW
Input Frequency Range	AC Input	47Hz		440Hz
Minimum Load		0%		
Hold-up time	115VAC		10ms	
Internal Operating Frequency	100% load at nominal Vin		132kHz	
Output Ripple and Noise ⁽⁶⁾	20MHz BW 3.3Vout all others			120mVp-p 150mVp-p

Notes:

Note5: Refer to line derating graph on page PA-3

Note6: Measurements are made with a 0.1µF MLCC across output (low ESR)

Efficiency vs. Load

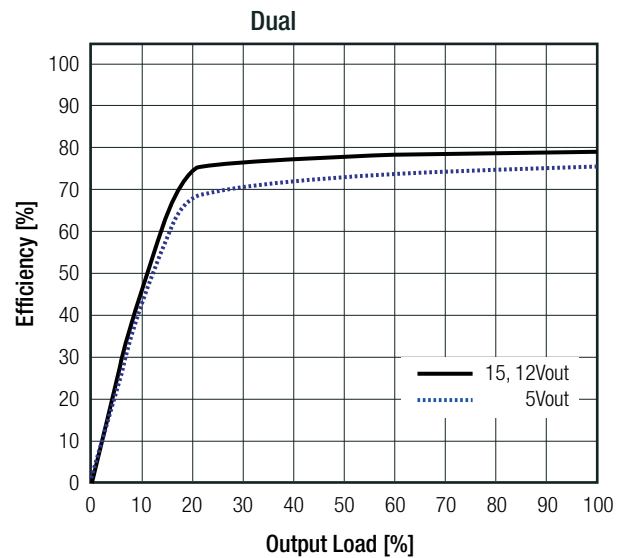
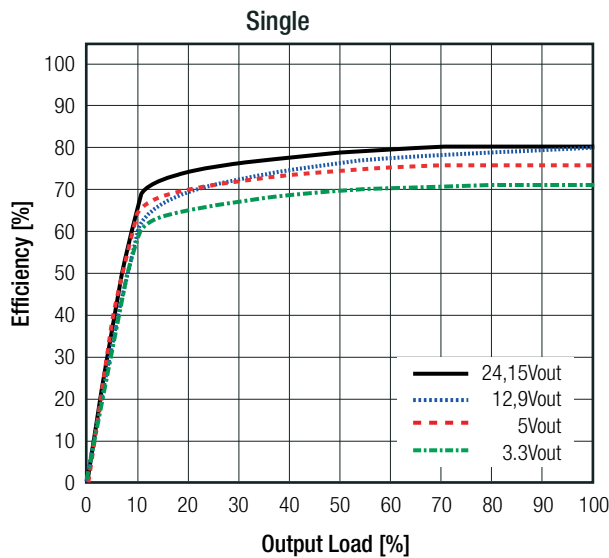

REGULATIONS

Parameter	Condition	Value
Output Accuracy		±2.0% max.
Line Regulation	low line to high line	±0.3% typ.
Load Regulation ⁽⁷⁾	5% to 100% load	0.5% typ.

Notes:

Note7: Operation below 5% load will not harm the converter, but specifications may not be met

Specifications (measured at Ta= 25°C, full load otherwise noted)

PROTECTIONS

Parameter	Type		Value
Short Circuit Protection (SCP)	below 100mΩ		Hiccup mode, automatic recovery
Over Load Protection (OLP)			115% - 145%
Over Voltage Protection (OVP)	zener diode clamp	3.3Vout all others	145% - 165% 110% - 135%
Over Voltage Category			OVCII
Isolation Voltage	I/P to O/P	tested for 1 minute	3kVAC
Isolation Resistance	I/P to O/P		1GΩ min.
Isolation Capacitance			1000pF typ.
Leakage Current			0.85mA max.

Notes:

Note8: Refer to local safety regulations if input over-current protection is also required. Recommended fuse: slow blow type

ENVIRONMENTAL

Parameter	Condition		Value
Operating Temperature Range ⁽⁸⁾	full load		-25°C to +55°C
	refer to derating graph		-25°C to +75°C
Operating Altitude			2000m
Operating Humidity	non-condensing		95% RH max.
Pollution Degree			PD2
MTBF	according to MIL-HDBK-217F, G.B.	+25°C	>400 x 10 ³ hours
		+55°C	>200 x 10 ³ hours

Derating Graph

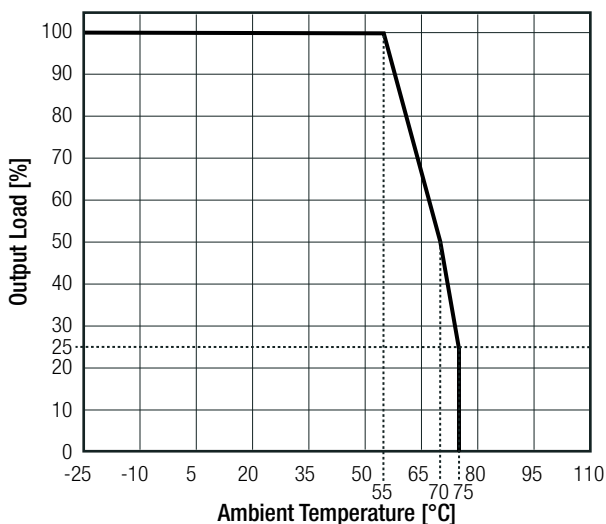

Line Derating

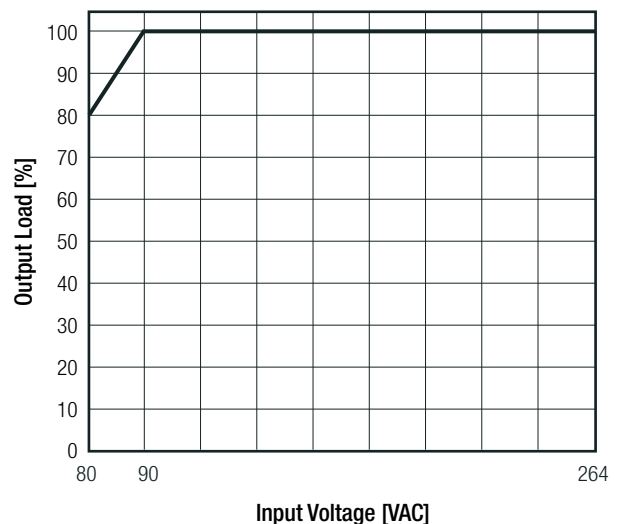

Specifications (measured at Ta= 25°C, full load otherwise noted)

SAFETY AND CERTIFICATIONS		
Certificate Type (Safety)	Report / File Number	Standard
Information Technology Equipment - General Requirments for Safety	E224736-A1-UL	UL60950-1, 2nd Edition, 2007 CAN/CSA-C22.2 No. 60950-1-07, 2nd Edition, 2007
Information Technology Equipment - General Requirments for Safety	SPCLVD1605077-06	IEC60950-1:2005 2nd Edition + A2:2013 EN60950-1:2006 + A2:2013
EAC Safety of Low Voltage Equipment	RU-AT.AB37.B.02367	TP TC 004/2011
RoHS2+		RoHS-2011/65/EU + AM-2015/863
EMC Compliance	Condition	Standard / Criterion
Electromagnetic compatibility of multimedia equipment – Emission Requirements		EN55032:2015
Information technology equipment - Immunity characteristics - Limits and methods of measurement		EN55024:2010 + A1:2015
ESD Electrostatic discharge immunity test	Air ±8.0kV, Contact ±4.0kV	IEC61000-4-2:2008, Criteria A
Radiated, radio-frequency, electromagnetic field immunity test	3V/m	IEC61000-4-3:2008, Criteria A
Fast Transient and Burst Immunity	AC Power Port: ±1.0kV	IEC61000-4-4:2004, Criteria A
Surge Immunity	AC Power Port: L-N ±1.0kV	IEC61000-4-5:2005, Criteria A
Immunity to conducted disturbances, induced by radio-frequency fields	AC Power Port 3.0V	IEC61000-4-6:2008, Criteria A
Power Magnetic Field Immunity	50Hz, 1A/m	IEC61000-4-8:2009, Criteria A
Voltage Dips and Interruptions	Voltage Dips >95%	IEC61000-4-11:2004, Criteria A
	Voltage Dips 30%	IEC61000-4-11:2004, Criteria A
	Voltage Interruptions > 95%	IEC61000-4-11:2004, Criteria B
Limits of Harmonic Current Emissions		EN61000-3-2:2014, Class A
Limits of Voltage Fluctuations & Flicker		EN61000-3-3:2013

DIMENSION AND PHYSICAL CHARACTERISTICS		
Parameter	Type	Value
Material	case	black plastic (UL94V-0)
	potting	epoxy (UL94V-0)
Dimension (LxWxH)	single	50.9 x 25.5 x 16.4mm
	dual	53.5 x 27.8 x 16.4mm
Weight	THT version	35g typ.
	wired version	38g typ.
continued on next page		

Specifications (measured at Ta= 25°C, full load otherwise noted)

Dimension Drawing Single (mm)

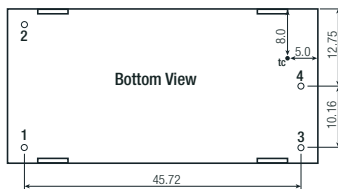
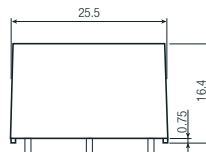
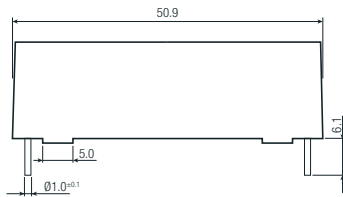
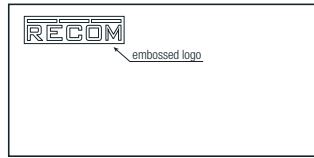
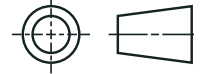

Recommended Footprint Details

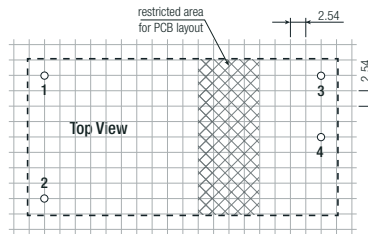

Pin Connections

Pin #	Single
1	VAC in (N)
2	VAC in (L)
3	+VDC out
4	-VDC out
5	no pin

tc= case temperature measuring point

Tolerance: xx.x= ±0.5mm

xx.xx= ±0.25mm

Dimension Drawing Dual (mm)

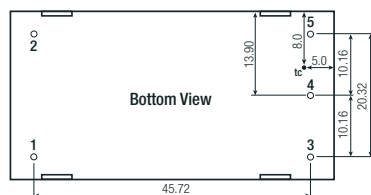
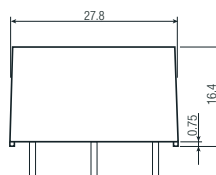
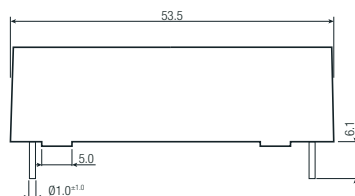
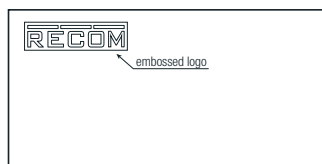

Recommended Footprint Details

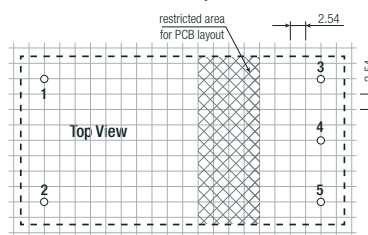

Pin Connections

Pin #	Dual
1	VAC in (N)
2	VAC in (L)
3	+VDC out
4	Com
5	-VDC out

tc= case temperature measuring point

Tolerance: xx.x= ±0.5mm

xx.xx= ±0.25mm

continued on next page

Specifications (measured at Ta= 25°C, full load otherwise noted)

Dimension Drawing Single wired (mm)

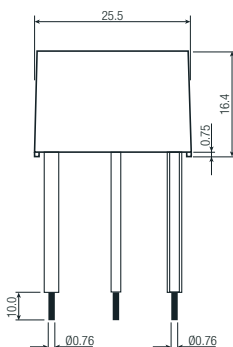
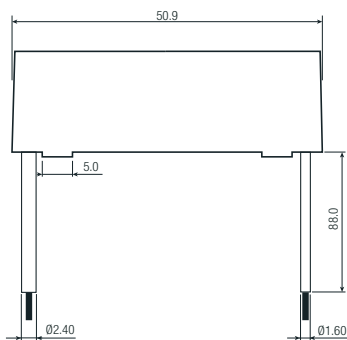
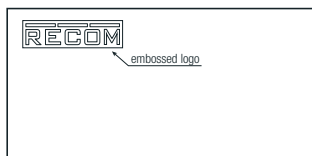

Wired information

#	Function	Wire color	Type	AWG
1	VAC in (N)	blue	UL-1015	22
2	VAC in (L)	bown	UL-1015	22
3	+VDC out	red	UL-1007	22
4	-VDC out	black	UL-1007	22

tc= case temperature measuring point
 Tolerance: xx.x= ±0.5mm
 xx.xx= ±0.25mm

Dimension Drawing Dual wired (mm)

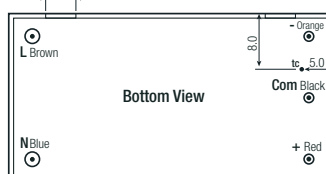
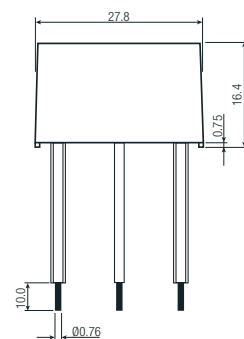
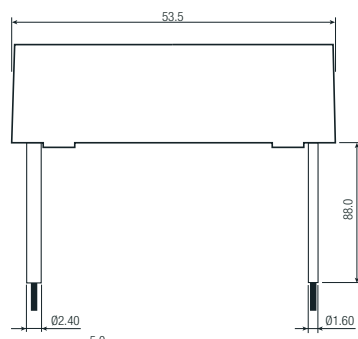
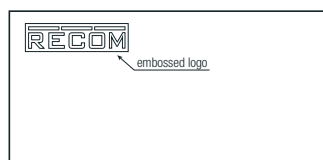

Wired information

#	Function	Wire color	Type	AWG
1	VAC in (N)	blue	UL-1015	22
2	VAC in (L)	bown	UL-1015	22
3	+VDC out	red	UL-1007	22
4	Com	black	UL-1007	22
5	-VDC out	orange	UL-1007	22

tc= case temperature measuring point
 Tolerance: xx.x= ±0.5mm
 xx.xx= ±0.25mm

Specifications (measured at Ta= 25°C, full load otherwise noted)

PACKAGING INFORMATION			
Parameter	Type		Value
Packaging Dimension (LxWxH)	tube	THT	520.0 x 56.0 x 26.0
	cardbox	wired	520.0 x 195.0 x 67.0
Packaging Quantity	THT single		10pcs
	THT dual		9pcs
	wired		20pcs
Storage Temperature Range			-40°C to +100°C
Storage Humidity	non-condensing		95% RH max.

The product information and specifications may be subject to changes even without prior written notice. The product has been designed for various applications; its suitability lies in the responsibility of each customer. The products are not authorized for use in safety-critical applications without RECOM's explicit written consent. A safety-critical application is an application where a failure may reasonably be expected to endanger or cause loss of life, inflict bodily harm or damage property. The applicant shall indemnify and hold harmless RECOM, its affiliated companies and its representatives against any damage claims in connection with the unauthorized use of RECOM products in such safety-critical applications.

X-ON Electronics

Largest Supplier of Electrical and Electronic Components

Click to view similar products for [AC/DC Power Modules category](#):

Click to view products by [Recom Power manufacturer](#):

Other Similar products are found below :

[ERP-350-12](#) [KPSB25-12-J](#) [KPSB25-15-J](#) [KPSB25-24-J](#) [KPSB25-36-J](#) [KPSB6-12-J](#) [KPSB6-5-J](#) [TPP 65-112E-D](#) [RAC05-05SK/PD3/H](#)
[AMEOF65-12SJZ](#) [AMEL10-12S277HAVZ-B](#) [RAC05-12SK/PD3/H](#) [AMEL20-3S277HAVZ-B](#) [AMEL20-5S277HAVZ-B](#) [AMEL45-24SJZ](#)
[AMEL30-12S277HAVZ](#) [AMEL30-15S277HAVZ](#) [AMEL30-3S277HAVZ](#) [AMEL30-5S277HAVZ](#) [AMEL30-9S277HAVZ](#) [AMEM5-](#)
[9S277HAVZ-B](#) [AMESP100-24S277NZ](#) [AMESP100-48S277NZ](#) [AMESP150-24S277NZ](#) [AMESP200-24S277NZ](#) [AMESP320-24S277NZ](#)
[AMESP320-48S277NZ](#) [AMESP75-12S277NZ](#) [AMESP75-24S277NZ](#) [AMESP75-48S277NZ](#) [ZP05S1200WB](#) [AM20CW-2405S-NZ](#)
[AMEL60-24SJZ](#) [AMEL60-48SJZ](#) [AMEM3-15S277HAVZ-B](#) [AMEM3-24S277HAVZ-B](#) [AMEM3-3S277HAVZ-B](#) [AMEM3-9S277HAVZ-B](#)
[AMEM5-12S277HAVZ-B](#) [AMEM5-15S277HAVZ-B](#) [AMEM5-5S277HAVZ-B](#) [AMEOF225-12SHAMJZ](#) [AME20-3.3SBJZ](#) [AME20-5SBJZ](#)
[AMEL15-24S277HAVZ-B](#) [AMEL15-5S277HAVZ-ST](#) [AMEL20-12S277HAVZ-B](#) [AMEL20-24S277HAVZ-B](#) [AMEL20-24S277HAVZ-STD](#)
[AME20-12SBJZ](#)