

Features

- Very compact low AC-DC power supply
- High efficiency
- Single and dual output options
- Continuous short circuit protection
- Isolated output 3.75kVAC / 1 minute
- EN55032 Class B compliant
- High operating temperature
- Low standby power consumption

Regulated Converter

Description

The RAC10-C/277 series are multipurpose 10 watt AC/DC power supplies for an extended mains input from 80VAC up to 305VAC. These modules are designed to power on-board applications in automation, Industry 4.0, IoT, lighting and smart buildings worldwide. The efficiency is constant over a wide load range and the standby power consumption is less than 0.3W. With universal input voltage covering 100/115/230/277VAC or 113-430VDC, fully protected single or dual outputs and EMC Class B emissions compliance without any external components, these are one of the easiest to use modular power solutions in the industry.

RAC10-C/277

10 Watt
Single and
Dual Output



Selection Guide

Part Number	Input Voltage Range [VAC]	Output Voltage [VDC]	Output Current [mA]	Efficiency typ ⁽¹⁾ [%]	Max. Capacitive Load ⁽²⁾ [µF]
RAC10-05SC/277	80-305	5	2000	78	36000
RAC10-12SC/277	80-305	12	840	80	8600
RAC10-15SC/277	80-305	15	670	78	6000
RAC10-24SC/277	80-305	24	420	80	2700
RAC10-12DC/277	80-305	±12	±420	79	±3700

Notes:

Note1: Measured @ 230VAC / 50Hz / Ta=25°C with constant resistant mode at full load

Note2: If used @ 115VAC / 60Hz with full load, max. capacitive load is less, please contact RECOM Tech Support for detailed information

NRND (Last time buy: 30th Oct 2020)

Part Number	Input Voltage Range [VAC]	Output Voltage [VDC]	Output Current [mA]	Efficiency typ ⁽¹⁾ [%]	Max. Capacitive Load ⁽²⁾ [µF]
RAC10-3.3SC/277	80-305	3.3	2500	75	50000
RAC10-05DC/277	80-305	±5	±1000	77	±21000
RAC10-15DC/277	80-305	±15	±340	79	±2900

PREFERRED ALTERNATIVES
Please consider these alternatives:

RAC10-K/277 Series

IEC/EN60950-1 certified
UL60950-1 certified
CAN/CSA-22.2 No. 60950-1-07 certified
EN55032 compliant
EN55024 compliant

Model Numbering

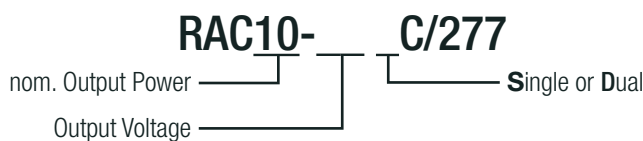

Ordering Examples:

RAC10-05SC/277 10 Watt 5Vout Single Output
RAC10-12DC/277 10 Watt 12Vout Dual Output

Specifications (measured @ Ta= 25°C, full load and after warm-up unless otherwise stated)

BASIC CHARACTERISTICS

Parameter	Condition		Min.	Typ.	Max.
Input Voltage Range ^(3,4)			80VAC 113VDC	277VAC	305VAC 430VDC
Input Current	115VAC 230VAC			250mA 160mA	
Inrush Current	cold start at +25°C	115VAC 230VAC			15A 30A
No load Power Consumption	230VAC				300mW
Input Frequency Range	AC Input		47Hz		63Hz
Minimum Load			0%		
Hold-up Time	230VAC/50Hz		60ms		
Internal Operating Frequency	full load at nominal Vin			100kHz	
Output Ripple and Noise ⁽⁵⁾	20MHz BW	3.3, 5Vout 12, 15, 24, ±12Vout ±5, ±15Vout		50mVp-p 125mVp-p 200mVp-p	

Notes:

- Note3: The products were submitted for safety files at AC-Input operation
- Note4: Refer to line derating graph on page PA-4
- Note5: Ripple and Noise is the maximum peak-to-peak voltage value measured at the output with a 20MHz bandwidth, at rated line voltage at full load and with a 0.1µF ceramic capacitor across output. Do not use scope ground lead to measure the output ripple and noise

Efficiency vs. Load

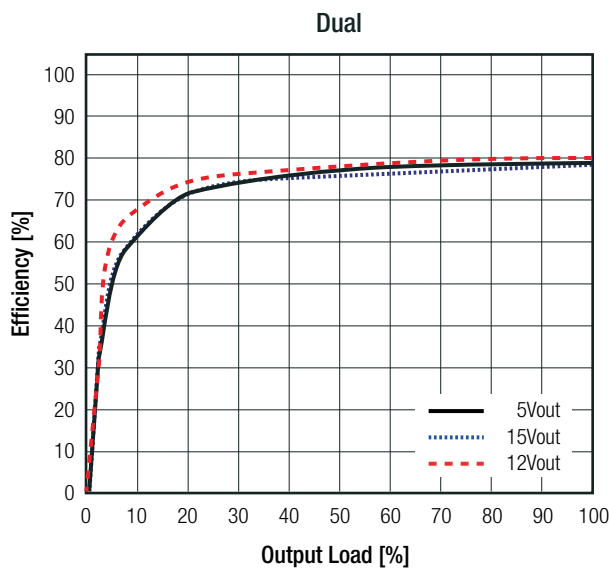
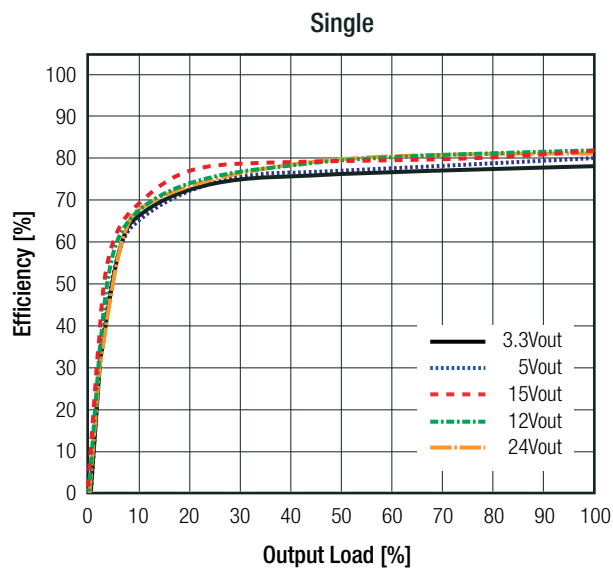

REGULATIONS

Parameter	Condition		Value
Output Accuracy	3.3Vout all others		±3.0% typ. ±2.0% typ.
Line Regulation	low line to high line, full load		±0.3% typ.
Load Regulation	0% to 100% load	3.3, 5Vout 12Vout all others	1.5% typ. 1.0% typ. 0.5% typ.

Specifications (measured @ Ta= 25°C, full load and after warm-up unless otherwise stated)

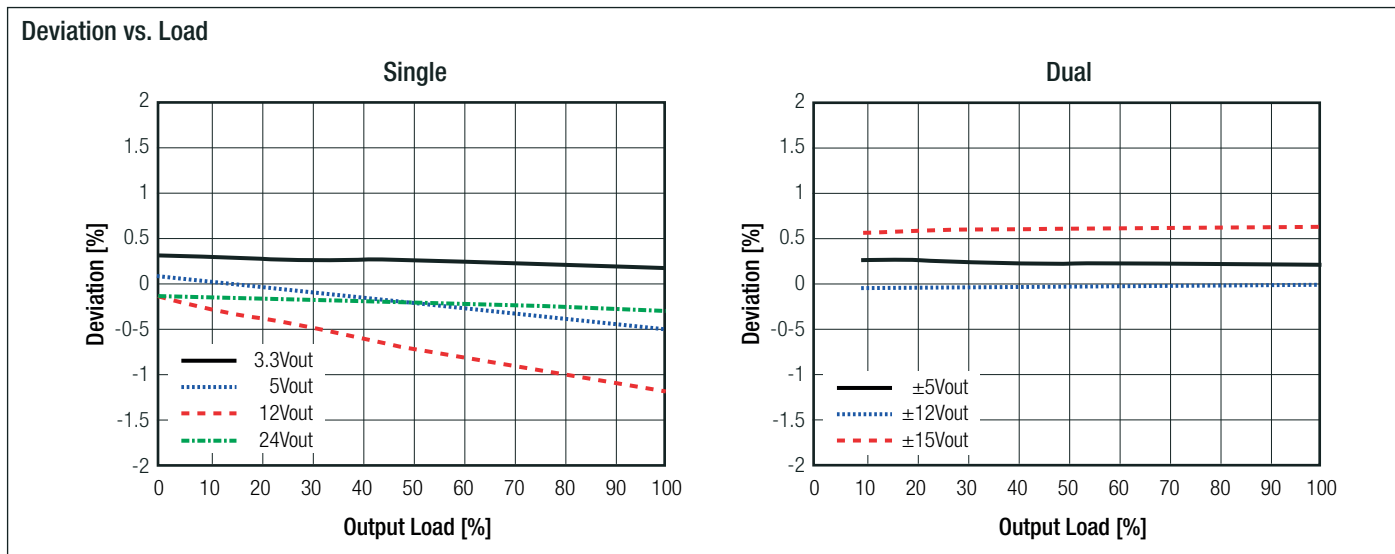

PROTECTIONS		
Parameter	Type	Value
Short Circuit Protection (SCP)	below 100mΩ	Hiccup mode, automatic recovery
Over Voltage Protection (OVP)		Latch off
Over Current Protection (OCP)		automatic recovery
Over Voltage Category		OVCII
Isolation Voltage	I/P to O/P	tested for 1 minute 3.75kVAC
Leakage Current	230VAC/50Hz	0.25mA max.
Notes:		
Note6: Refer to local safety regulations if input over-current protection is also required. Recommended fuse: slow blow type		

ENVIRONMENTAL			
Parameter	Condition		Value
Operating Temperature Range	@ free air convection	full load	-20°C to +70°C
Operating Humidity	non-condensing		5% - 95% RH max.
MTBF	according to MIL-HDBK-217F, G.B.	+25°C	320 x 10 ³ hours
		+70°C	120 x 10 ³ hours
continued on next page			

Specifications (measured @ Ta= 25°C, full load and after warm-up unless otherwise stated)

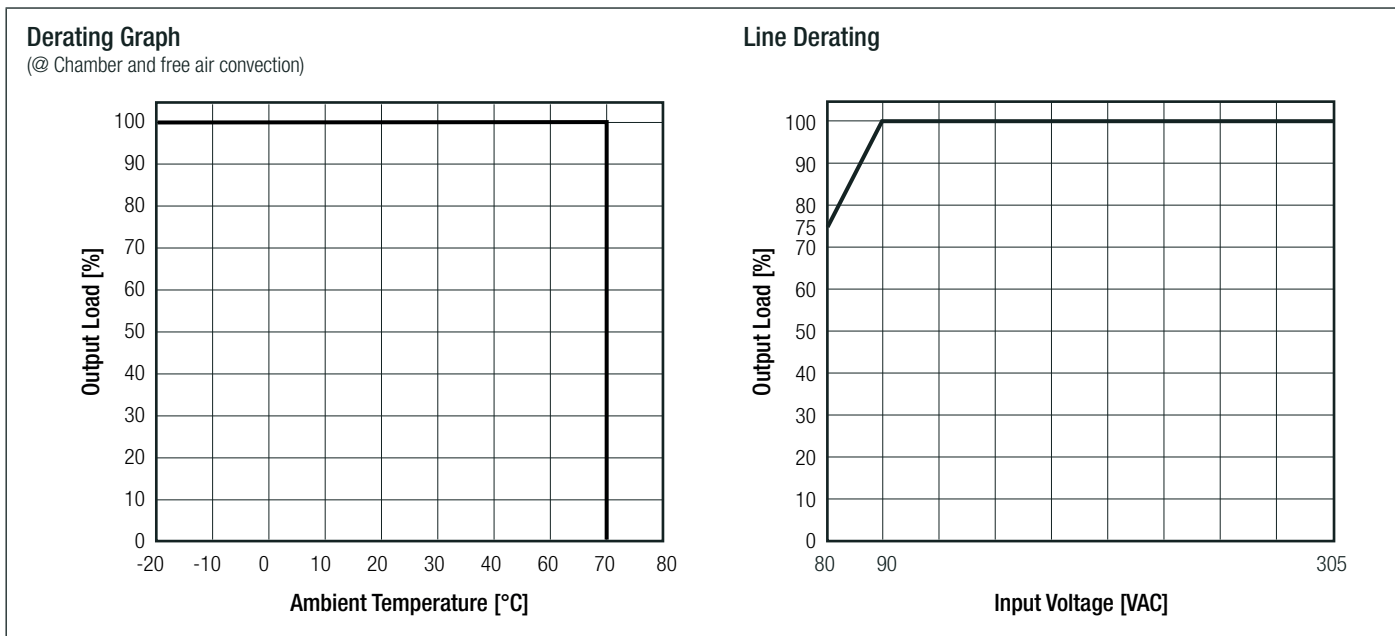

SAFETY AND CERTIFICATIONS		
Certificate Type (Safety)	Report / File Number	Standard
Information Technology Equipment, General Requirements for Safety	E224736-A49-UL	UL60950-1, 2nd Edition, 2011 CAN/CSA-C22.2 60950-1, 2nd Edition, 2011
Information Technology Equipment, General Requirements for Safety	SPCLVD1605077-05	EN60950-1:2006 + A2:2013 IEC60950-1:2005, 2nd Edition + A2:2013
EAC Safety of Low Voltage Equipment	RU-AT.49.09571	TP TC 004/2011
RoHS2+		RoHS-2011/65/EU + AM-2015/863
EMC Compliance	Condition	Standard / Criterion
Electromagnetic compatibility of multimedia equipment – Emission Requirements		EN55032:2015, Class B
Information technology equipment - Immunity characteristics - Limits and methods of measurement		EN55024:2010
ESD Electrostatic discharge immunity test	±8kV Air, ±4kV Contact	EN61000-4-2:2009, Criteria B
Radiated, radio-frequency, electromagnetic field immunity test	3V/m	EN61000-4-3:2006 + A2:2010, Criteria A
Fast Transient and Burst Immunity	AC Power Port: +/-1.0kV	IEC61000-4-4:2004+A1:2010, Criteria A
Surge Immunity	AC Power Port: L-N +/-1.0kV	IEC61000-4-5:2005, Criteria A
Immunity to conducted disturbances, induced by radio-frequency fields	AC Power Port 3V	IEC61000-4-6:2008, Criteria A
Power Magnetic Field Immunity	50Hz, 1A/m	EN61000-4-8:2010, Criteria A
Voltage Dips and Interruptions	Voltage Dips >95%	EN61000-4-11:2004, Criteria A
	Voltage Dips 30%	EN61000-4-11:2004, Criteria A
	Voltage Interruptions >95%	EN61000-4-11:2004, Criteria B
Limits of Voltage Fluctuations & Flicker		EN61000-3-3:2013

DIMENSION AND PHYSICAL CHARACTERISTICS		
Parameter	Type	Value
Material	case	epoxy with fibreglass, (UL94V-0)
Dimension (LxWxH)		52.5 x 27.4 x 23.5mm
Weight		62g typ.

continued on next page

Specifications (measured @ Ta= 25°C, full load and after warm-up unless otherwise stated)

Dimension Drawing (mm)

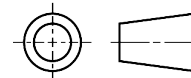
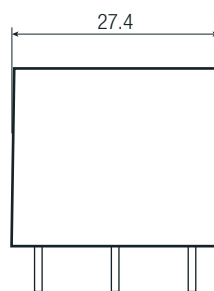
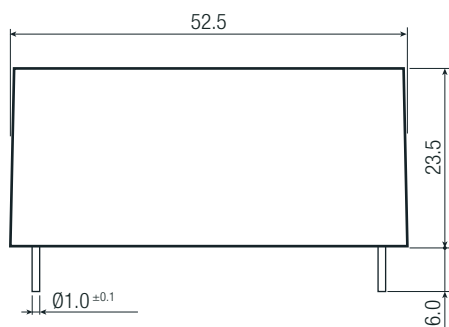
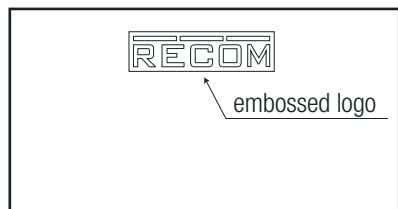

Pin Connections

Pin #	Single	Dual
1	VAC in (N)	VAC in (N)
2	VAC in (L)	VAC in (L)
3	no pin	-VDC out
4	-VDC out	Com
5	+VDC out	+VDC out

Tolerance: xx.x= ±0.5mm
xx.xx= ±0.25mm

Recommended Footprint Details

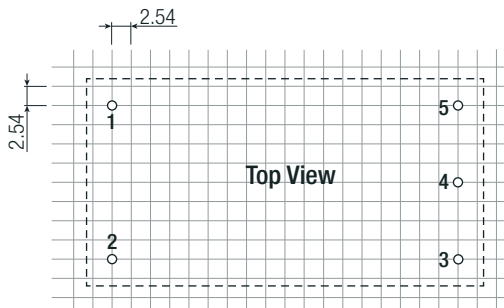
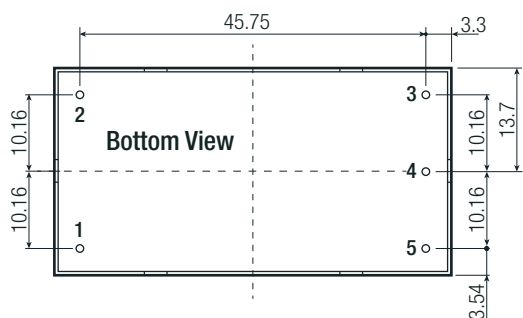

PACKAGING INFORMATION		
Parameter	Type	Value
Packaging Dimension (LxWxH)		520.0 x 56.0 x 32.0mm
Packaging Quantity		16pcs.
Storage Temperature Range		-40°C to +75°C
Storage Humidity	non-condensing	95% RH max.

The product information and specifications may be subject to changes even without prior written notice. The product has been designed for various applications; its suitability lies in the responsibility of each customer. The products are not authorized for use in safety-critical applications without RECOM's explicit written consent. A safety-critical application is an application where a failure may reasonably be expected to endanger or cause loss of life, inflict bodily harm or damage property. The applicant shall indemnify and hold harmless RECOM, its affiliated companies and its representatives against any damage claims in connection with the unauthorized use of RECOM products in such safety-critical applications.

X-ON Electronics

Largest Supplier of Electrical and Electronic Components

Click to view similar products for [AC/DC Power Modules category](#):

Click to view products by [RECOM POWER manufacturer](#):

Other Similar products are found below :

[ERP-350-12](#) [KPSB25-12-J](#) [KPSB25-15-J](#) [KPSB25-24-J](#) [KPSB25-36-J](#) [KPSB6-12-J](#) [KPSB6-5-J](#) [TPP 65-112E-D](#) [RAC05-05SK/PD3/H](#)
[AMEOF65-12SJZ](#) [AMEL10-12S277HAVZ-B](#) [RAC05-12SK/PD3/H](#) [AMEL20-3S277HAVZ-B](#) [AMEL20-5S277HAVZ-B](#) [AMEL45-24SJZ](#)
[AMEL30-12S277HAVZ](#) [AMEL30-15S277HAVZ](#) [AMEL30-3S277HAVZ](#) [AMEL30-5S277HAVZ](#) [AMEL30-9S277HAVZ](#) [AMEM5-](#)
[9S277HAVZ-B](#) [AMESP100-24S277NZ](#) [AMESP100-48S277NZ](#) [AMESP150-24S277NZ](#) [AMESP200-24S277NZ](#) [AMESP320-24S277NZ](#)
[AMESP320-48S277NZ](#) [AMESP75-12S277NZ](#) [AMESP75-24S277NZ](#) [AMESP75-48S277NZ](#) [AM20CW-2405S-NZ](#) [AMEL60-24SJZ](#)
[AMEL60-48SJZ](#) [AMEM3-15S277HAVZ-B](#) [AMEM3-24S277HAVZ-B](#) [AMEM3-3S277HAVZ-B](#) [AMEM3-9S277HAVZ-B](#) [AMEM5-](#)
[12S277HAVZ-B](#) [AMEM5-15S277HAVZ-B](#) [AMEM5-5S277HAVZ-B](#) [AMEOF225-12SHAMJZ](#) [AME20-3.3SBJZ](#) [AME20-5SBJZ](#) [AMEL15-](#)
[24S277HAVZ-B](#) [AMEL15-5S277HAVZ-ST](#) [AMEL20-12S277HAVZ-B](#) [AMEL20-24S277HAVZ-B](#) [AMEL20-24S277HAVZ-STD](#) [AME20-](#)
[12SBJZ](#) [AMEOF450-24SHAMJZ](#)