

## Features

- Universal input 90-264VAC
- Efficiency up to 86%
- Short circuit and over voltage/current protected
- UL/EN60950 certified, CE marked
- Conformal coated product

## Regulated Converter

## RAC35-G/OF

35 Watt

4" x 2"

Open Frame



UL60950 certified  
CAN/CSA C22.2 N.60950-1-07 certified  
EN60950-1 certified  
EN55032 compliant  
EN55024 compliant

## Description

The RAC35-xxG/OF series are low cost, 4"x2" AC/DC power supplies with universal input (90-264VAC) and fully protected and isolated DC outputs in the range of 5V up to 48V. The converters are offered in open frame (/OF) version. The outputs are trimmable to compensate for cable losses and are short circuit and overload protected. The converters work over a wide temperature range of -25°C to +65°C (with derating), are UL60950, EN60950 and CE certified and comply with Class B EMC limits. The RAC35-G series come with a three year warranty.

## Selection Guide

Part Number	Input Voltage Range [VAC]	Output Voltage [VDC]	max. Output Current [mA]	Efficiency typ. <sup>(1)</sup> [%]
RAC35-05SG/OF	90-264	5	6000	78
RAC35-12SG/OF	90-264	12	3000	81
RAC35-24SG/OF	90-264	24	1500	83
RAC35-48SG/OF	90-264	48	750	86

### Notes:

Note1: Efficiency is tested at nominal input and full load at +25°C ambient

## Model Numbering



### Ordering Examples:

RAC35-24SG/OF	24Vout	Single	open frame version
RAC35-12SG/OF	12Vout	Single	open frame version

**PREFERRED ALTERNATIVES**  
Please consider these alternatives:

**RACM60-K Series**

**Specifications** (measured @ Ta= 25°C, nom. Vin and full load unless otherwise stated)

**BASIC CHARACTERISTICS**

Parameter	Condition	Min.	Typ.	Max.
Output Power				36W
Input Voltage Range		90VAC	230VAC	264VAC
Input Current	115VAC 230VAC			1A 0.6A
Inrush Current	cold start at 25°C 115VAC 230VAC			23A 45A
No load Power Consumption	230VAC		0.5W	
Input Frequency Range		47Hz		63Hz
Output Voltage Trimming	5Vout 12Vout 24Vout 48Vout	4.75VDC 11.4VDC 22.8VDC 45.6VDC		5.5VDC 13.2VDC 26.4VDC 52.8VDC
Minimum Load		0%		
Power Factor	115VAC 230VAC		0.6 0.5	
Start-up Time	115VAC 230VAC			2s 1s
Rise Time	115VAC 230VAC		10ms 8ms	
Hold-up Time	115VAC 230VAC		10ms 20ms	
Internal Operating Frequency		65kHz		100kHz
Output Ripple and Noise <sup>(2)</sup>	20MHz BW			200mVp-p

**Notes:**

Note2: Measurements are made with a 1.0µF & 10µF parallel capacitor

**Efficiency vs. Load**

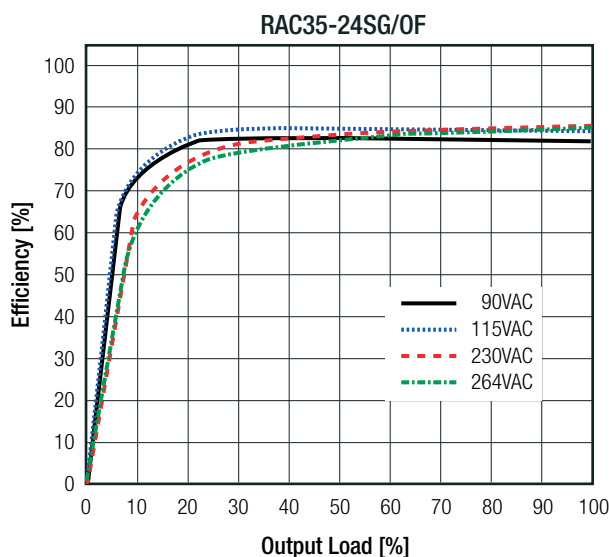
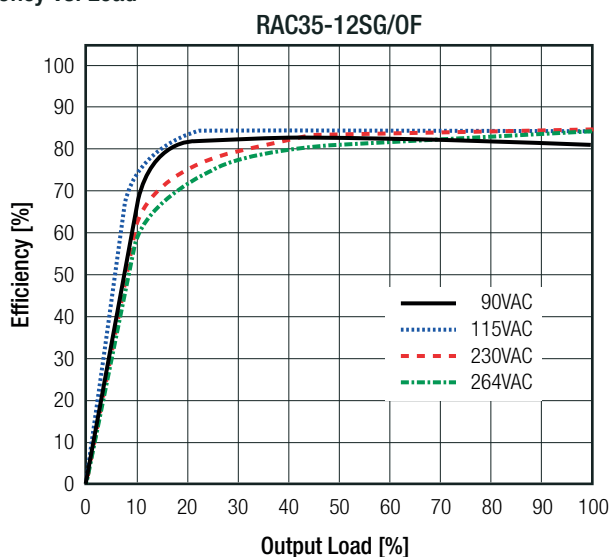

**REGULATIONS**

Parameter	Condition	Value
Output Accuracy		±1.0% typ.
Line Regulation		±0.5% typ.
Load Regulation	10%-100% load	1.0% typ.

**Specifications** (measured @ Ta= 25°C, nom. Vin and full load unless otherwise stated)

PROTECTIONS			
Parameter	Type		Value
Input fuse	internal		T3.15A / 250V slow blow
Short Circuit Protection (SCP)			continuous, auto recovery
Over Voltage Protection (OVP)	115-135% of Vout nominal		Latch OFF
Over Current Protection (OCP)	5VDC		6.3 - 10.8A
	12VDC		3.15 - 5.4A
	24VDC		1.58 - 2.7A
	48VDC		0.78 - 1.35A
Class of Equipment			Class I
Isolation Voltage	tested for 1 minute	I/P to O/P	3kVAC
		I/P to PE	1.5kVAC
		O/P to PE	0.5kVDC
Isolation Resistance	I/P to O/P		100MΩ min.
Isolation Capacitance			2200pF max.
Insulation Grade			reinforced
Leakage Current	I/P to O/P		0.25mA max.
	O/P to FG		3.5mA max.
<b>Notes:</b>			
Note3: Refer to local safety regulations if input over-current protection is also required			

ENVIRONMENTAL			
Parameter	Condition		Value
Operating Temperature Range	@ natural convection 0.1m/s	full load	-25°C to +50°C
		refer to derating graph	-25°C to +65°C
Temperature Coefficient			±0.03%/K typ.
Operating Altitude <sup>(4)</sup>			5000m
Operating Humidity	non-condensing		20% - 90% RH max.
Pollution Degree			PD2
Conformal Coating			provided
Shock			20G, 11ms, 3 times for X,Y and Z axis
MTBF	according to MIL-HDBK-217F, G.B.	+25°C	200 x 10 <sup>3</sup> hours
<b>Notes:</b>			
Note4: Recognized by UL for safe operation up to 5000m. High altitude operation may impact the performance and lifetime Contact RECOM techsupport for advice			
continued on next page			

**Specifications** (measured @ Ta= 25°C, nom. Vin and full load unless otherwise stated)

**Derating Graph**

(@ Chamber and natural convection 0.1 m/s)

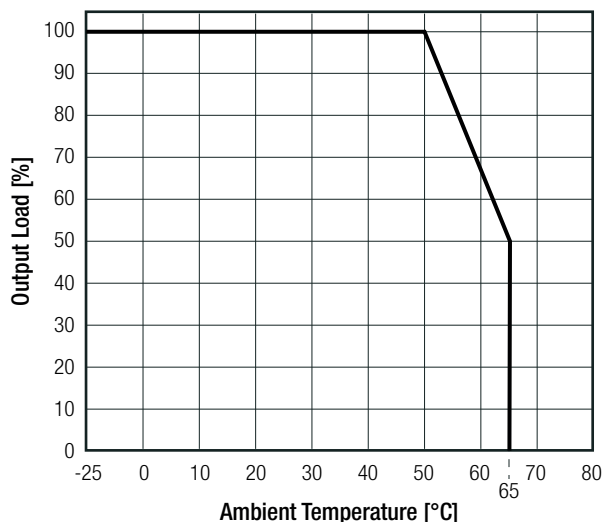

**Operating Altitude**

(limitation E-Cap heatsink)

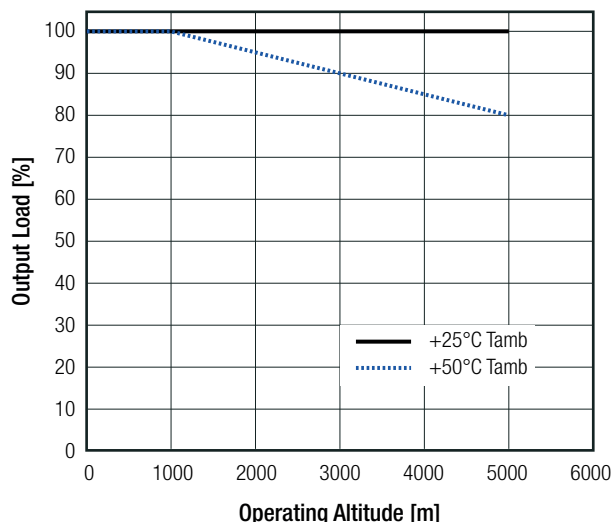

**SAFETY AND CERTIFICATIONS**

Certificate Type (Safety)	Report / File Number	Standard
Information Technology Equipment, General Requirements for Safety	E196683	UL60950-1, 2nd Edition, 2014 CSA C22.2 No. 60950-1-07, 2nd Ed. 2014
Information Technology Equipment, General Requirements for Safety (LVD)	SA1406027L01001	EN60950-1, 2nd Edition, 2013
EAC Safety of Low Voltage Equipment	RU-AT.49.09571	TP TC 004/2011
RoHS2+		RoHS 2011/65/EU + AM2015/863

EMC Compliance	Conditions	Standard / Criterion
Electromagnetic compatibility of multimedia equipment – Emission Requirements	without external filter	EN55032:2015, Class B
Information technology equipment - Immunity characteristics - Limits and methods of measurement		EN55024:2010 + A1:2015
ESD Electrostatic discharge immunity test	±8kV Air; ±4kV Contact	EN61000-4-2, Criteria A
Radiated, radio-frequency, electromagnetic field immunity test	3V/m	EN61000-4-3, Criteria A
Fast Transient and Burst Immunity	AC Power Port: ±1.0kV	EN61000-4-4, Criteria A
Surge Immunity	AC Power Port: L-L ±1.0kV L-PE ±2.0kV N-PE ±2.0kV	EN61000-4-5, Criteria B
Immunity to conducted disturbances, induced by radio-frequency fields	AC Power Port: 3V	EN61000-4-6, Criteria A
Power Magnetic Field Immunity	50Hz, 1A/m	EN61000-4-8, Criteria A
Voltage Dips and Interruptions	Dips: >95% reduction Interruption: >95%	EN61000-4-11, Criteria A EN61000-4-11, Criteria C
Limits of Harmonic Current Emissions		EN61000-3-2, Criteria A
Limits of Voltage Fluctuations & Flicker		EN61000-3-3

**Specifications** (measured @ Ta= 25°C, nom. Vin and full load unless otherwise stated)

DIMENSION AND PHYSICAL CHARACTERISTICS		
Parameter	Type	Value
Material	PCB	FR4 (UL94-V0)
Dimension (LxWxH)		101.6 x 51.0 x 28.0mm
Weight		126g typ.

Dimension Drawing Open Frame (mm)

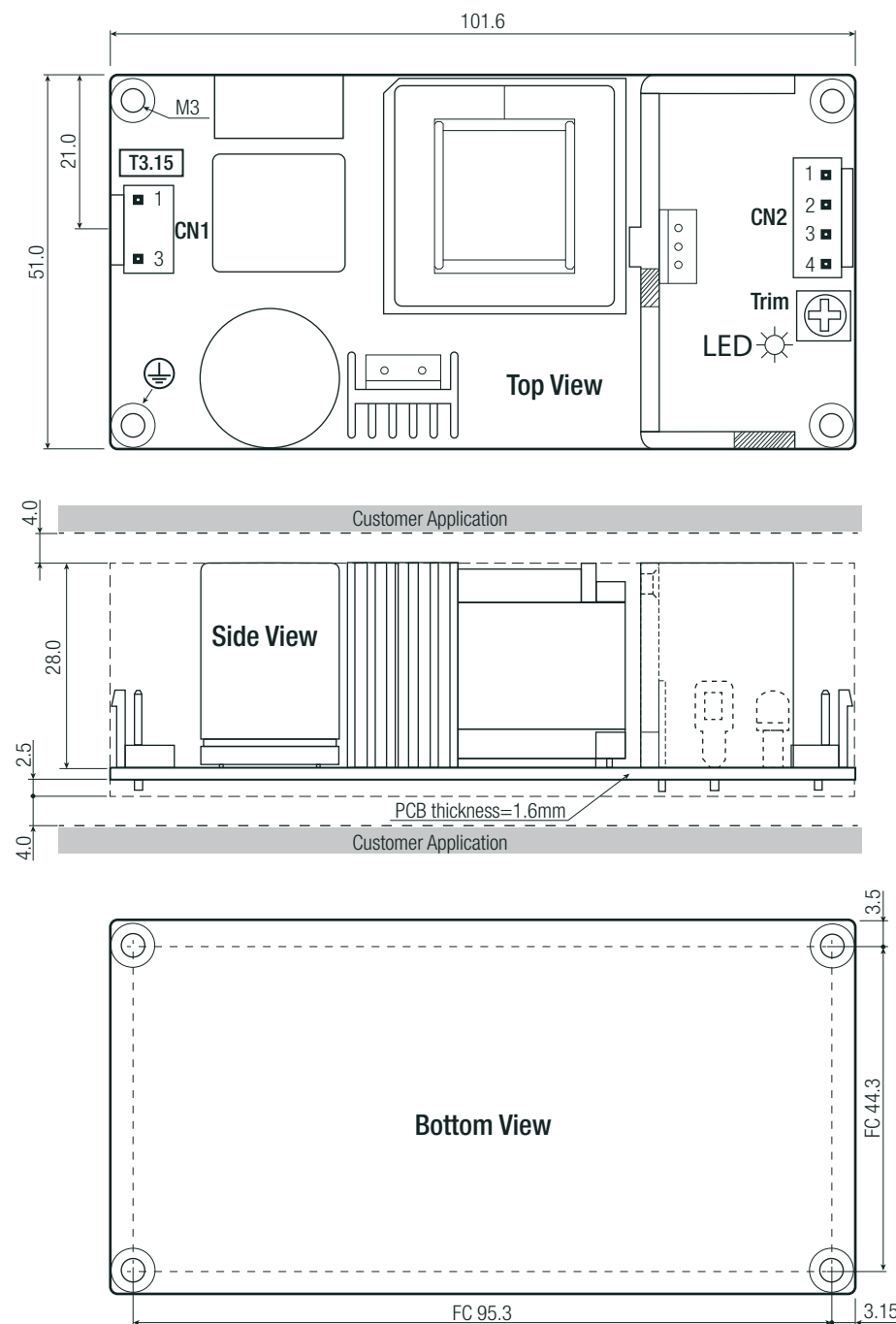
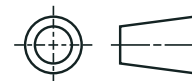

**Connections**

**AC Input (CN1)**

Pin #	Terminal
1 AC/L	3 Pins (Pin2 removed) with 3.96mm pitch
3 AC/N	3.96mm pitch

**DC Output (CN2)**

Pin #	Terminal
1,2 V+	4 Pins with 3.96mm pitch
3,4 V-	3.96mm pitch

FC= fixing centers  
Crimp Terminal AWG Range: 18-22AWG  
Tolerance: xx.X= ±1.0mm  
              xx.xx= ±0.5mm

**Compatible Connectors**

**Housing**

Landwin 3960S Series  
JST VHR  
Molex 51144 Series

**Crimp Terminal**

Landwin 3963T011R  
JST SVH-21T-P1.1  
Molex 50539

continued on next page

**Specifications** (measured @ Ta= 25°C, nom. Vin and full load unless otherwise stated)

**APPLICATION and INSTALLATION**

**Mounting**

**horizontal (standard)**

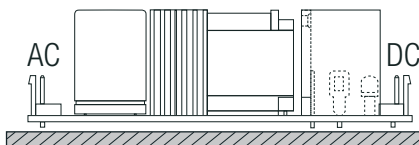

If module is mounted vertical or upside-down with natural convection cooling, the power must be derated  $\geq 10\%$ .

**vertical**

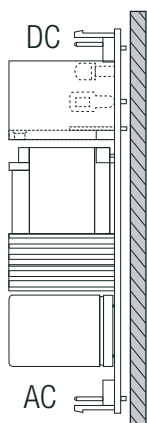

**upside-down**

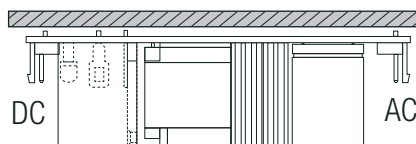

**Block diagram**

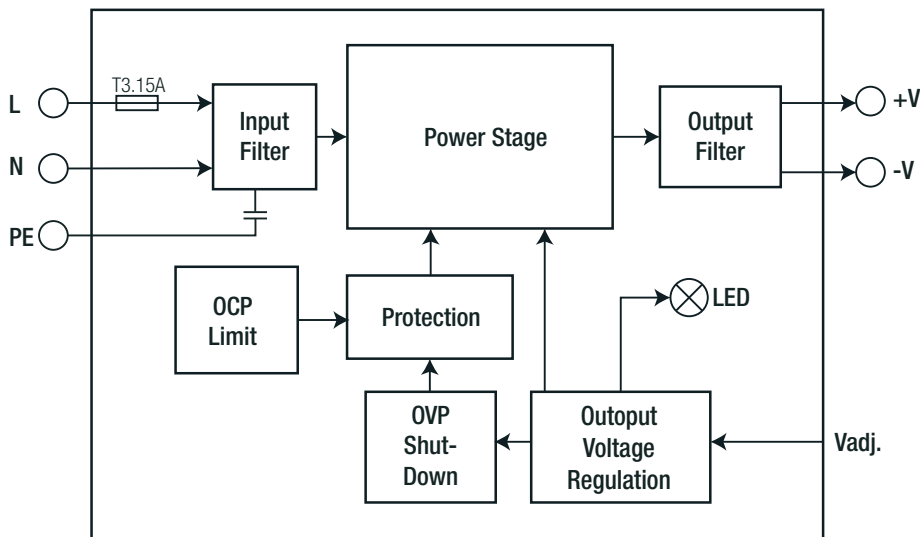

**PACKAGING INFORMATION**

Parameter	Type	Value
Packaging Dimension (LxWxH)	cardboard box	174.0 x 125.0 x 266.0mm
Packaging Quantity		10pcs
Storage Temperature Range		-40°C to +85°C
Storage Humidity	non-condensing	10% - 95% RH max.

The product information and specifications may be subject to changes even without prior written notice. The product has been designed for various applications; its suitability lies in the responsibility of each customer. The products are not authorized for use in safety-critical applications without RECOM's explicit written consent. A safety-critical application is an application where a failure may reasonably be expected to endanger or cause loss of life, inflict bodily harm or damage property. The applicant shall indemnify and hold harmless RECOM, its affiliated companies and its representatives against any damage claims in connection with the unauthorized use of RECOM products in such safety-critical applications.

## X-ON Electronics

Largest Supplier of Electrical and Electronic Components

*Click to view similar products for [AC/DC Power Modules](#) category:*

*Click to view products by [Recom Power](#) manufacturer:*

Other Similar products are found below :

[VI-HAM-CM](#) [ERP-350-12](#) [KPSB25-12-J](#) [KPSB25-15-J](#) [KPSB25-24-J](#) [KPSB25-36-J](#) [KPSB25-5-J](#) [KPSB6-12-J](#) [KPSB6-5-J](#) [TMPS 03-112](#)  
[TMPS 03-115](#) [TMPS 03-124](#) [IRM-03-9S](#) [LFWLT300-CK](#) [TMPS 03-109](#) [TPP 40-112](#) [TPP 65-105](#) [TPP 65-112](#) [VOF-275-48](#) [RAC04-](#)  
[12DC/277-E](#) [RAC04-12SC/277-E](#) [RAC04-05DC/277-E](#) [RAC04-0512DC/277-E](#) [PFE700SA-48/T](#) [MFM-15-12](#) [MFM-15-5](#) [MFM-20-12](#)  
[MFM-20-5](#) [MPM-05-12](#) [MPM-05-24](#) [MPM-05-5](#) [MPM-10-12](#) [MPM-10-24](#) [MPM-15-24](#) [MPM-15-5](#) [MPM-20-12](#) [MPM-20-24](#) [MPM-20-5](#)  
[MPM-30-12](#) [MPM-30-24](#) [MPM-30-5](#) [RAC01-05SGA](#) [RAC01-05SGB](#) [RAC01-12SGB](#) [RAC02-05SGA](#) [RAC02-05SGB](#) [RAC02-12SGA](#)  
[RAC03-05SGA](#) [RAC03-05SGB](#) [RAC03-12SGA](#)