

RACM15E-K Series ◊ AC/DC Power Supply

15W ◊ Input: 100V-240VAC

FEATURES

- Panel- and DIN-rail mount or open card fixation
- CV/CC: constant voltage; constant current limited
- -40°C to +85°C operating temperature ratings
- OVC III rated up to 3000m Altitude
- 2MOPP rating
- EN55032 class “B” compliant @ floating load
- 1.5U cabinet space requirements
- 3 year warranty

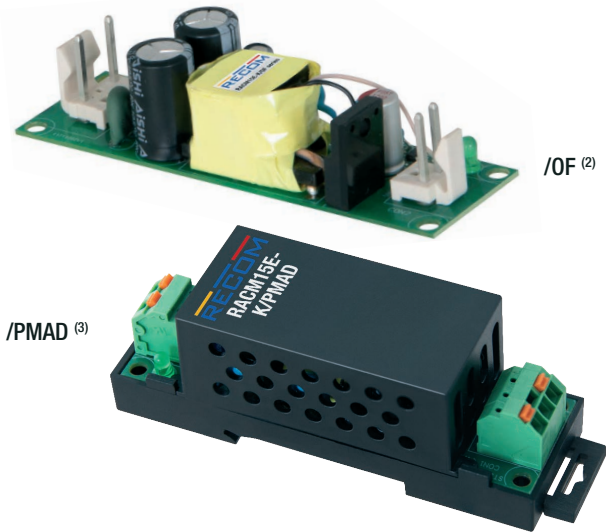

/OF= Open frame: 3.1 x 0.9 x 0.8 inch

/PMAD= Panel & Din rail mount: 3.2 x 1.0 x 1.1 inch

APPLICATIONS

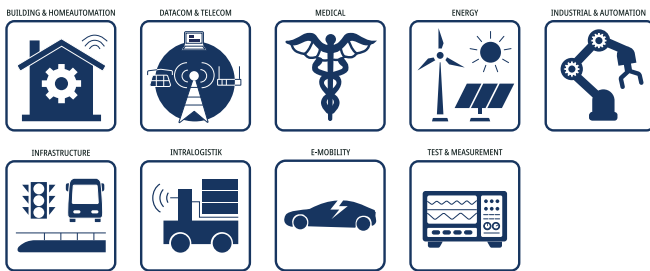

SAFETY & EMC



DESCRIPTION

RACM15E-K, the cost-effective chameleons among AC/DC power supply series, adheres to different connection and mounting criteria such as open card placement for connection via pre-assembled harness, or IP20-protected enclosures with push-in terminals for direct fixation to mounting plates, as well as for snapping onto DIN rails with 1.5U slotsize. CV/CC regulated output voltages from 3.3 to 30Vdc with overcurrent limited power of 15 Watt are provided under still air convection at -40° to 50°C ambient temperature. International certifications to medical; household; industrial and safety transformer standards ensure simplified integration into applications for use up to 5000m altitude or 3000m at OVC III overvoltage rating requirements. All models meet EN55032 Class “B” EMI guidelines in floating load configurations.

SELECTION GUIDE

Part Number	Input Voltage Range [VAC]	Output Voltage nom. [VDC]	Output Current rated [mA]	Efficiency ⁽¹⁾ typ. [%]	Output Power max. [W]
RACM15E-3.3SK ⁽²⁾	80-275	3.3	3640	78	12
RACM15E-05SK ^(2, 3)	80-275	5	3000	82	15
RACM15E-12SK ^(2, 3)	80-275	12	1250	84.5	15
RACM15E-15SK ^(2, 3)	80-275	15	1000	85	15
RACM15E-24SK ^(2, 3)	80-275	24	625	86	15
RACM15E-30SK ^(2, 3)	80-275	30	500	86	15

Note1: Efficiency is tested at 230VAC and full load at +25°C ambient

RACM15E-K Series \diamond AC/DC Power Supply

15W \diamond Input: 100V-240VAC

Model Numbering



Note2: add suffix "/OF" for open frame version

Note3: add suffix "/PMAD-CTN" for panel mount version with 45° angled push-in terminal (except 3.3Vout)

BASIC CHARACTERISTICS (measured @ $T_{AMB} = 25^{\circ}C$, nom. V_{IN} , full load and after warm-up unless otherwise stated)

Parameter	Condition	Min.	Typ.	Max.
Nominal Input Voltage	50/60Hz	100VAC		240VAC
Operating Range ⁽⁴⁾	47-63Hz	80VAC		275VAC
	DC	120VDC		370VDC
Input Current	115/230VAC	200mA	250mA	450mA
Inrush Current	cold start at 25°C	115VAC		20A
		230VAC		30A
No Load Power Consumption	RACM15E-30SK		100mW	150mW
	others		75mW	100mW
Input Frequency Range	AC Input	47Hz		63Hz
Minimum Load		0%		
Power Factor	115VAC		0.6	
	230VAC		0.5	
Start-up time			600ms	1000ms
Rise time				60ms
Hold-up time	230VAC	50ms		
Internal Operating Frequency				70kHz
Output Ripple and Noise ⁽⁵⁾	20MHz BW	RACM15E-24SK; RACM15E-30SK		1% Vout
		others		150mVp-p

Note4: The products were submitted for safety files at AC-Input operation.

Note5: Measurements are made with a 0.1 μ F MLCC & 10 μ F E-cap in parallel across output. (low ESR)

The test setup can have an impact on ripple noise values (placement of scope probe, capacitors, it's specifications, wires, PCB tracks, distances, etc.)

RACM15E-3.3SK/277; RACM15E-05SK/277

RACM15E-3.3SK = 12W max.

Efficiency vs. Load

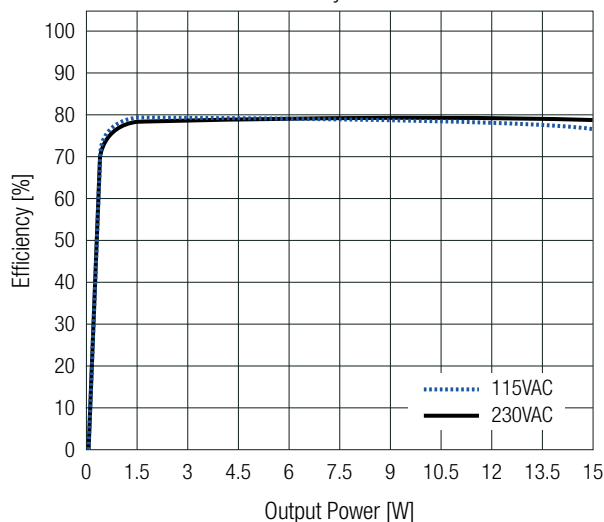

Power Dissipation vs. Load

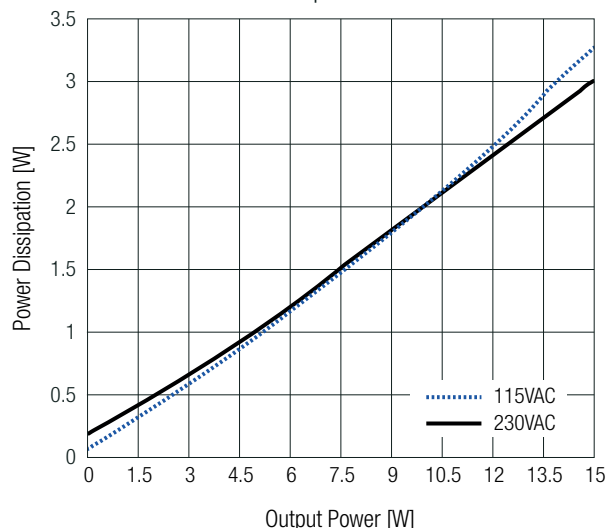

RACM15E-K Series \diamond AC/DC Power Supply

15W \diamond Input: 100V-240VAC

BASIC CHARACTERISTICS (measured @ $T_{AMB}= 25^{\circ}\text{C}$, nom. V_{IN} , full load and after warm-up unless otherwise stated)

others

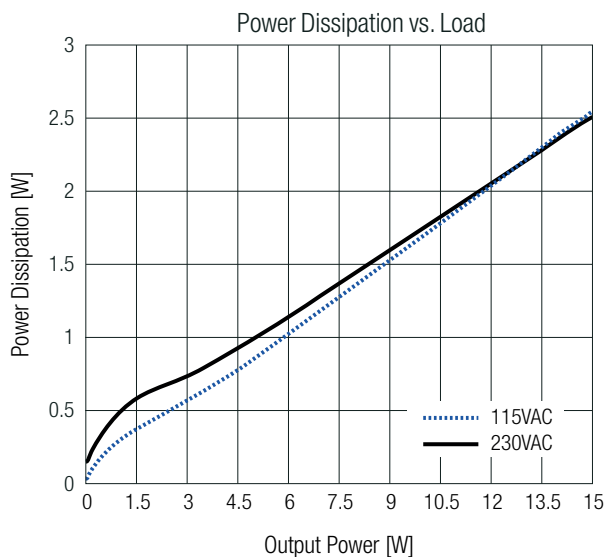
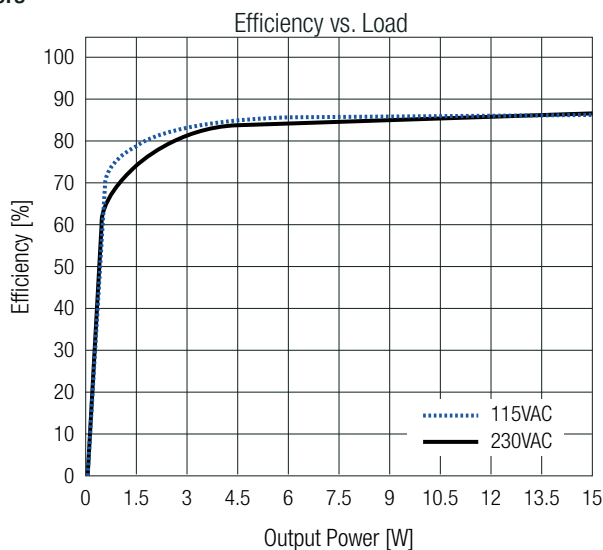

REGULATIONS (measured @ $T_{AMB}= 25^{\circ}\text{C}$, nom. V_{IN} , full load and after warm-up unless otherwise stated)

Parameter	Condition		Value
Output Accuracy			$\pm 2.0\%$ max.
Line Regulation	low line to high line, full load	RACM15E-3.3SK; RACM15E-05SK	$\pm 0.5\%$ max.
		others	$\pm 0.2\%$ max.
Load Regulation ⁽⁶⁾	10% to 100% load		1.0% max.
Transient Response	25% load step change		4.0% max.
	recovery time		500 μs typ.

Note6: Operation below 10% load will not harm the converter, but specifications may not be met

PROTECTIONS (measured @ $T_{AMB}= 25^{\circ}\text{C}$, nom. V_{IN} , full load and after warm-up unless otherwise stated)

Parameter	Type		Value
Input Fuse ⁽⁷⁾	internal		T2A, slow blow type
Limited Power Source (LPS)			yes
Short Circuit Protection (SCP)	below 100m Ω		hiccup mode; auto recovery
Over Load Protection	refer to „Output Voltage vs. Output Current“		constant current limitation until hiccup mode
Over Voltage Protection (OVP)			120% - 195%, hiccup mode
Over Voltage Category (OVC)	according to 62368-1, 60601-1		OVCII (5000m)
	according to 61558-2-16, 60335-1		OVCIII (3000m)
DC ON LED			green light, output voltage present
Class of Equipment			Class II
Isolation Voltage ⁽⁸⁾	I/P to O/P; 1 minute	according to 61558	4.2kVAC
		according to 62368-1	4kVDC
Isolation Resistance	$V_{ISO}=500\text{VDC}$		1G Ω min.
Isolation Capacitance	I/P to O/P, 100kHz/0.1V		100pF max.
Insulation Grade	I/P to O/P		reinforced
Means of Protection	according to 60601-1		2MOPP
Medical Device Classification	built-in power supply		designed to support type BF applications
Touch Current	264VAC/63Hz	normal condition	<100 μA
		single fault	<500 μA

Note7: For system integration with DC operation, consider a suitable DC fuse in front of the input

Note8: For repeat Hi-Pot testing, reduce the time and/or the test voltage

PROTECTIONS (measured @ $T_{AMB} = 25^{\circ}\text{C}$, nom. V_{IN} , full load and after warm-up unless otherwise stated)

Output Voltage vs. Output Current

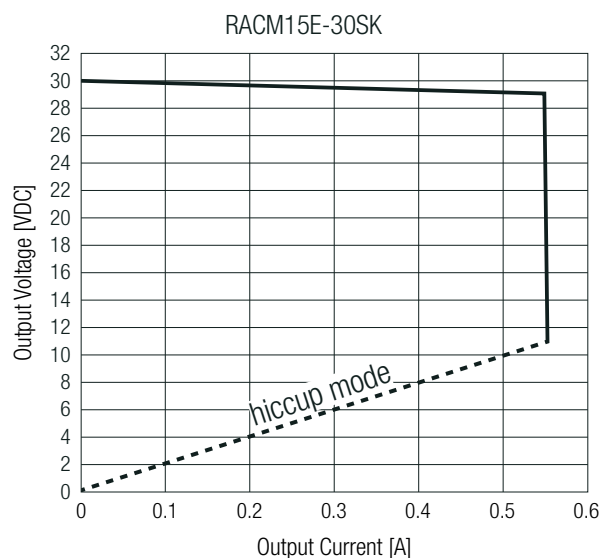
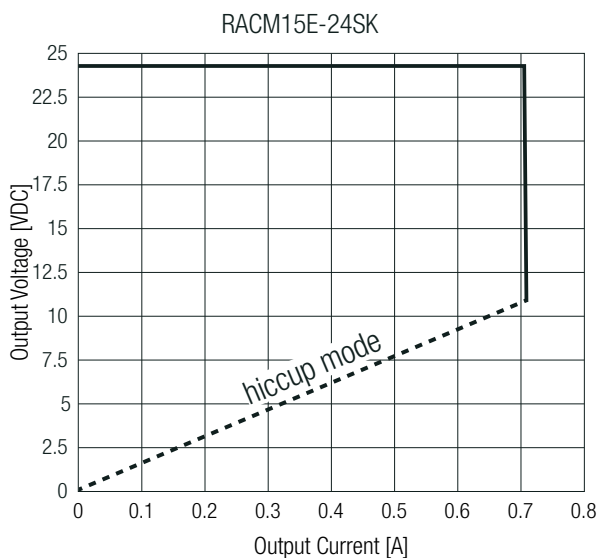
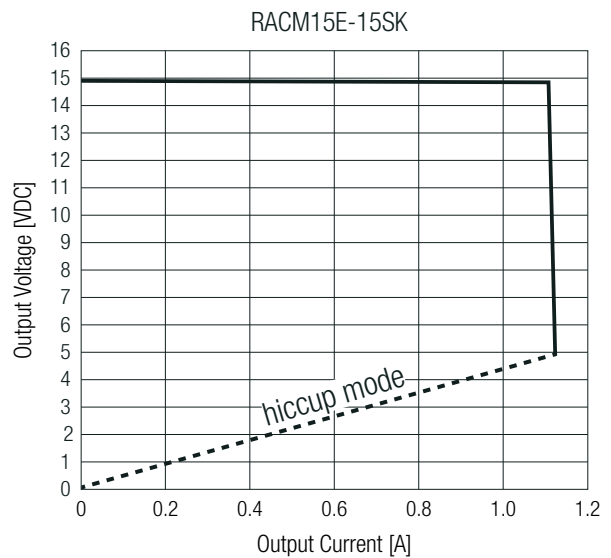
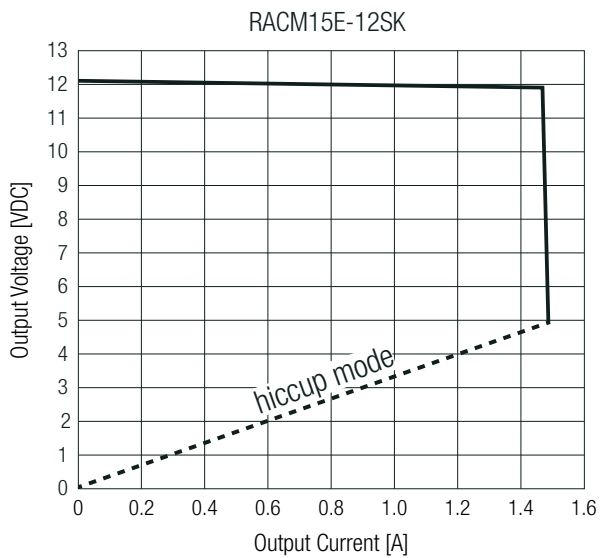
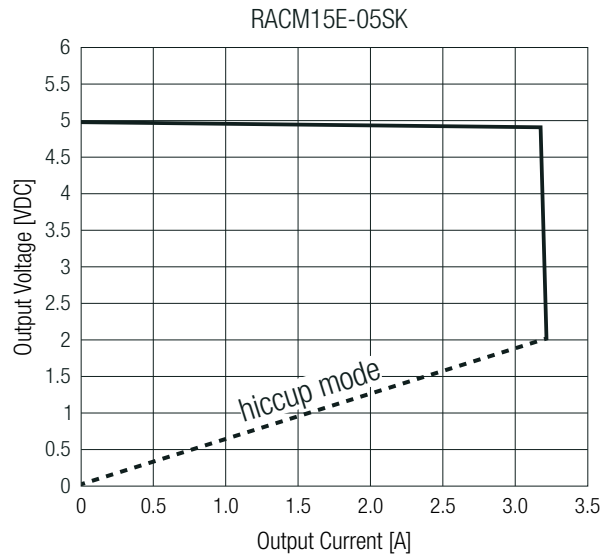
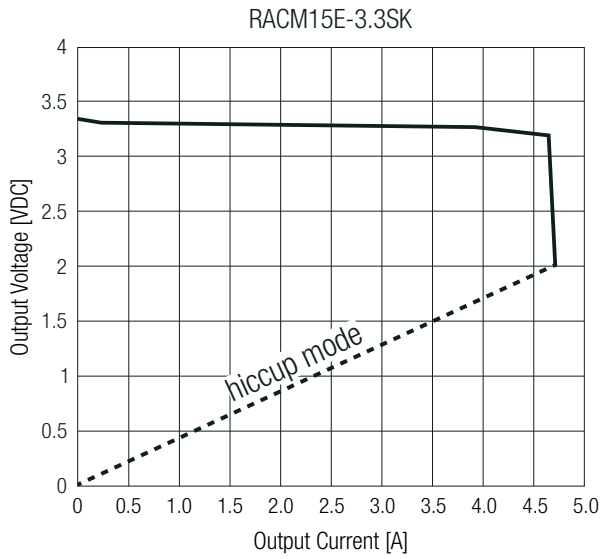

RACM15E-K Series \diamond AC/DC Power Supply

15W \diamond Input: 100V-240VAC

ENVIRONMENTAL (measured @ $T_{AMB} = 25^{\circ}\text{C}$, nom. V_{IN} , full load and after warm-up unless otherwise stated)

Parameter	Condition		Value
Operating Ambient Temperature Range	@ natural convection (0.1m/s); refer to „Derating Graph“		-40°C to +85°C
Maximum Case Temperature			+110°C
Temperature Coefficient			$\pm 0.02\%/K$
Operating Altitude ⁽⁹⁾	according to 62368-1, 60601-1		5000m (OVCI)
	according to 61558-2-16, 60335-1		3000m (OVCI)
Operating Humidity	non-condensing		90% RH max.
Pollution Degree			PD2
Vibration	according to MIL-STD-202G		10-500Hz, 10min.: 1cycle, period / 60min. each along x,y,z axes
MTBF	according to MIL-HDBK-217, G.B.	$T_{AMB} = +25^{\circ}\text{C}$	1261×10^3 hours
		$T_{AMB} = +40^{\circ}\text{C}$	1091×10^3 hours
Design Lifetime	230VAC and full load	$T_{AMB} = +50^{\circ}\text{C}$	30×10^3 hours

Note9: Recognized by safety agency for safe operation up to 5000m. High altitude operation may impact the performance and lifetime. Please contact RECOM tech support for advice

Derating Graph

(@ Chamber and natural convection 0.1m/s) ⁽¹⁰⁾

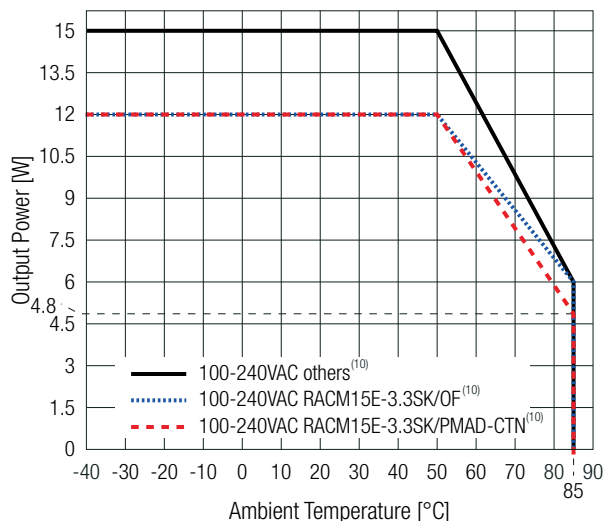

Note10: Nominal mains voltages are rated for tolerances of [nom. + $\pm 10\%$]

SAFETY & CERTIFICATIONS

Certificate Type (Safety)	Report Number	Standard
Audio/Video, information and communication technology equipment - Part1: Safety requirements 3rd Edition (CB)	085-230123101-000	IEC62368-1:2018 3rd Edition
Audio/Video, information and communication technology equipment - Part1: Safety requirements 3rd Edition		EN IEC 62368-1:2020+A11:2020
Audio/Video, information and communication technology equipment - Part1: Safety requirements 2nd Edition (LVD)	64.210.23.01232.01	EN62368-1:2014+A11:2017
Medical electrical equipment Part 1: General requirements for basic safety and essential performance	E511305-D6002-UL	ANSI/AAMI ES60601-1:2005 + A2:2021 Edition 3.2 CAN/CSA-C22.2 No. 60601-1:14 A2:2022 Edition 3.2
Medical electrical equipment Part 1: General requirements for basic safety and essential performance (CB)	23SBDS03024-01721	IEC60601-1:2005 + AMD2:2020 Edition 3.2
Medical electrical equipment Part 1: General requirements for basic safety and essential performance		EN60601-1:2006 + A2:2021
Household and similar electrical appliances – Safety – Part 1: General requirements	64.260.23.01234.01	IEC60335-1:2010 + C1:2016 5th Edition EN60335-1:2012 + A15:2021
Measurement methods for electromagnetic fields of household appliances and similar apparatus with regard to human exposure		EN62233:2008+AC:2008
Safety of power transformers, power supplies, reactors and similar products for supply voltages up to 1100 V 3rd Edition (CB)	085-230123301-000	IEC61558-1:2017 3rd Edition

RACM15E-K Series ◊ AC/DC Power Supply

15W ◊ Input: 100V-240VAC



SAFETY & CERTIFICATIONS

Certificate Type (Safety)	Report Number	Standard
Safety of power transformers, power supplies, reactors and similar products for supply voltages up to 1100 V 3rd Edition (LVD)	64.250.23.01233.01	EN IEC 61558-1:2019
Safety of power transformers, power supplies, reactors and similar products for supply voltages up to 1100 V Part 2: Particular requirements (CB)	085-230123301-000	IEC61558-2-16:2009 + A1:2013 1st Edition
Safety of power transformers, power supplies, reactors and similar products for supply voltages up to 1100 V Part 2: Particular requirements (LVD)	64.250.23.01233.01	EN61558-2-16:2009 + A1:2013
RoHS2		RoHS 2011/65/EU + AM2015/863

EMC Compliance (EN60601-1-2)	Condition	Standard / Criterion
Medical electrical equipment Part 1-2: General requirements for basic safety and essential performance		EN60601-1-2:2015
ESD Electrostatic discharge immunity test	Contact: ±8kV	IEC61000-4-2:2008 EN61000-4-2:2009
Radiated, radio-frequency, electromagnetic field immunity test	10 V/m (80-2700MHz), 27V/m (385MHz), 28V/m (450MHz), 9V/m (710, 745, 780MHz), 28V/m (810, 870, 930MHz), 28V/m (1720, 1845, 1970MHz), 28V/m (2450MHz), 9V/m (5240, 5500, 5785MHz)	IEC/EN61000-4-3:2066+A2:2010
Fast Transient and Burst Immunity	AC Port: L, N, L-N: 2kV	IEC/EN61000-4-4:2012
Surge Immunity	AC Port: L-N: ±0.5, 1, 2kV	IEC/EN61000-4-5:2014 + A1:2017
Immunity to conducted disturbances, induced by radio-frequency fields	3, 6Vrms (0.15-80MHz)	IEC61000-4-6:2013 EN61000-4-6:2014
Power Magnetic Field Immunity	30A/m	IEC61000-4-8:2009 EN61000-4-8:2010
Voltage Dips	100% (0.5P, 1.0P); 30%	IEC/EN61000-4-11:2004+A1:2017
Voltage Interruptions	100%	

EMC Compliance (EN61204-3)	Condition	Standard / Criterion
Low voltage power supplies, d.c. output Part 3: Electromagnetic compatibility (EMC)		EN IEC 61204-3:2018, Class B
ESD Electrostatic discharge immunity test	Contact: ±4kV	IEC61000-4-2:2008, Criteria A EN61000-4-2:2009, Criteria A
Radiated, radio-frequency, electromagnetic field immunity test	10V/m (80-1000MHz), 3V/m (1400-2000MHz), 1V/m (2000-2700MHz)	IEC/EN61000-4-3:2006 + A2:2010, Criteria A
Fast Transient and Burst Immunity	AC Port: L, N, L-N: 2kV	IEC/EN61000-4-4:2012, Criteria A
Surge Immunity	AC Port: L-N: ±1kV	IEC/EN61000-4-5:2014 + A1:2017, Criteria A
Immunity to conducted disturbances, induced by radio-frequency fields	10Vrms (0.15-80MHz)	IEC61000-4-6: 2013, Criteria A EN61000-4-6:2014, Criteria A
Power Magnetic Field Immunity	30A/m	IEC61000-4-8:2009, Criteria A EN61000-4-8:2010, Criteria A
Voltage Dips	100% (0.5P; 1.0P), 20%, 30%	IEC/EN61000-4-11:2004 + A1:2017, Criteria A
	60%	IEC/EN61000-4-11:2004 + A1:2017, Criteria B
Voltage Interruptions	100%	IEC/EN61000-4-11:2004 + A1:2017, Criteria B
Limits of Voltage Fluctuations & Flicker		EN61000-3-3:2013 + A1:2019

EMC Compliance (EN55032)	Condition	Standard / Criterion
Electromagnetic compatibility of multimedia equipment - Emission Requirements	O/P connected to GND:	EN55032:2015+A11:2020, Class B
Limitations on the amount of electromagnetic interference allowed from digital and electronic devices	refer to: "PELV installation" and floating output; without external filter	FCC 47 CFR Part 15 Subpart B, Class B

RACM15E-K Series \diamond AC/DC Power Supply

15W \diamond Input: 100V-240VAC

SAFETY & CERTIFICATIONS

Suggested external filter for PELV installation (refer to „EMC Compliance (EN55032)“

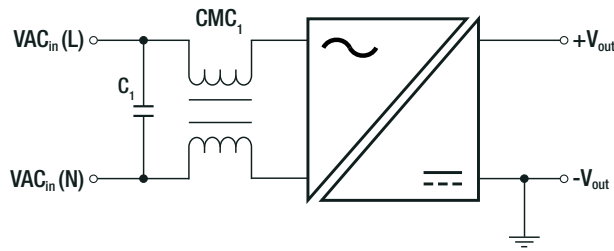

Component List

C ₁	CMC ₁
0.22 μ F	45mH: RACMC45-500/UF9.8 (coming soon)

DIMENSION & PHYSICAL CHARACTERISTICS

Parameter	Type	Value
Materials	case/baseplate	plastic, (UL94-V0)
	potting (PMAD-CTN versions only)	PU, (UL94-V0)
	PCB	FR4, (UL94-V0)
Dimension (LxWxH)	"/OF"	80.0 x 23.8 x 22.0mm 3.1 x 0.9 x 0.8 inch
	"/PMAD-CTN"	83.0 x 26.4 x 29.5mm 3.2 x 1.0 x 1.1 inch
Weight	"/OF"	48g typ. 0.10 lbs
	"/PMAD-CTN"	60g typ. 0.13 lbs

Dimension Drawing "/OF" version (mm)

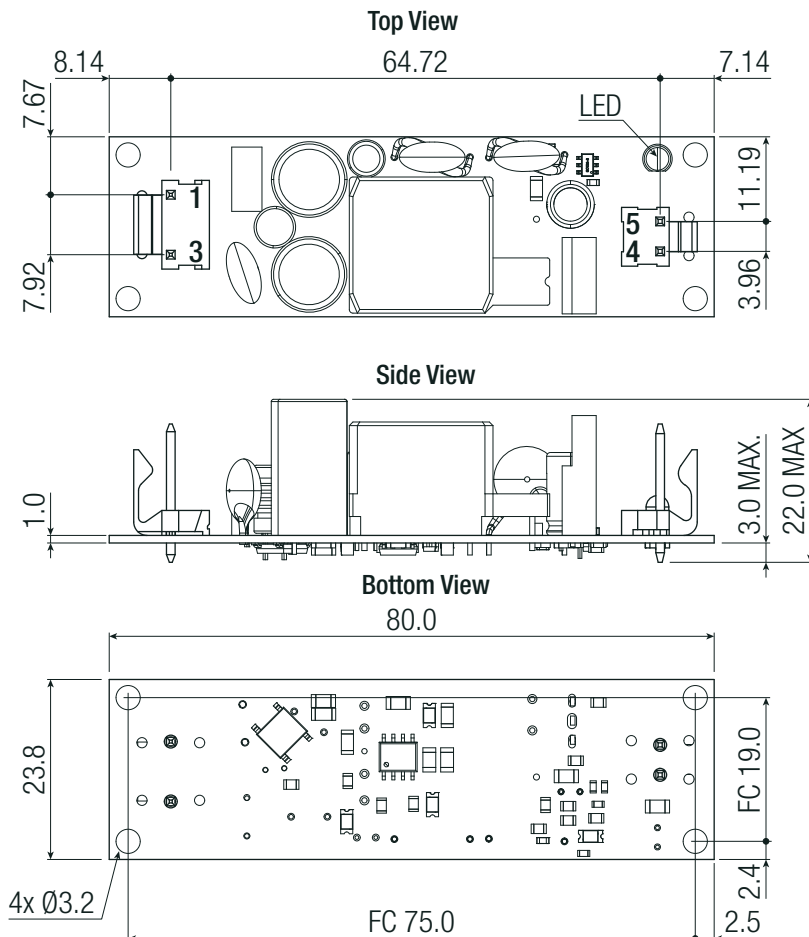

AC Input Side

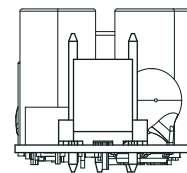

DC Output Side

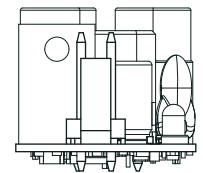

Connector Information

AC Input (CON1)

#	Function	Wire cross section ⁽¹⁾
1	VAC in (L)	26-21 AWG (0.5-1.5mm ²)
3	VAC in (N)	Usable wire: solid/stranded

DC Output (CON2)

#	Function	Wire cross section ⁽¹⁾
4	+Vout	26-21 AWG (0.5-1.5mm ²)
5	-Vout	Usable wire: solid/stranded

FC= Fixing centers

Compatible Connector

Housing	Crimp Terminal
Molex 41695 Series or equivalent	Molex 2478 Series or equivalent

Tolerance: xx.x= \pm 0.5mm
xx.xx= \pm 0.25mm

DIMENSION & PHYSICAL CHARACTERISTICS

Dimension Drawing "/PMAD-CTN" version (mm)

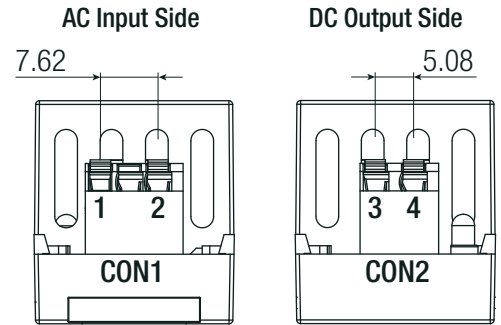
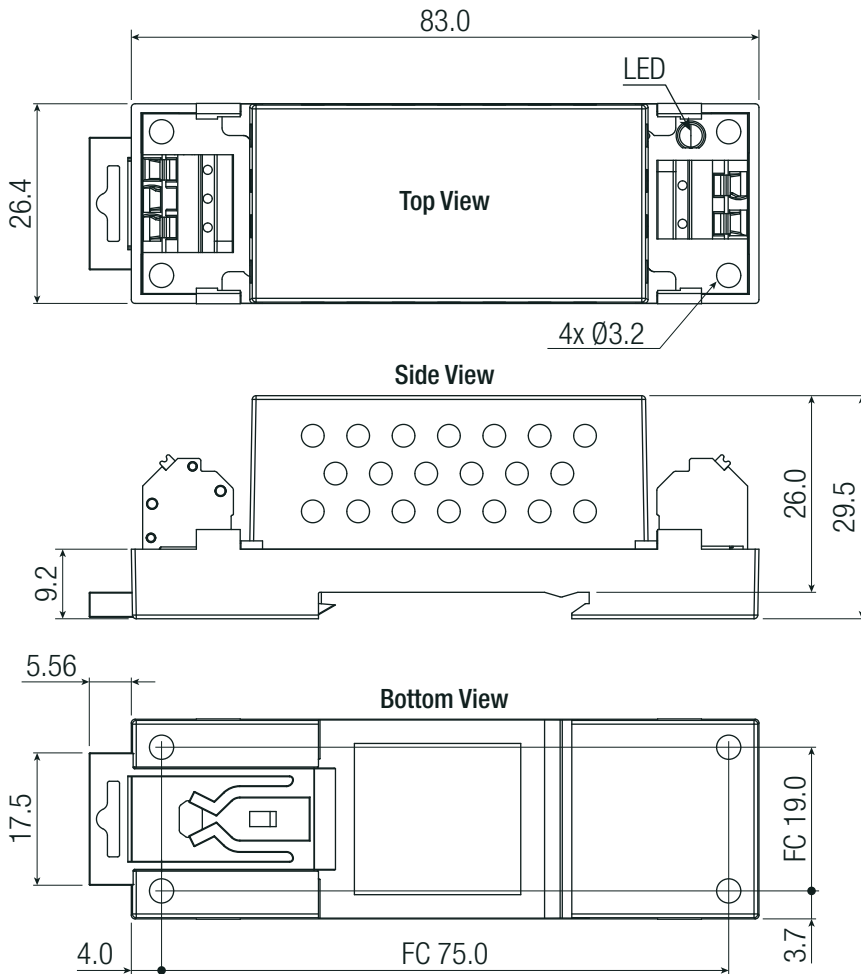

Push-In Spring Terminal

AC Input (CON1)

#	Function	Wire cross section ⁽¹⁾
1	VAC in (L)	26-21 AWG (0.5-1.5mm ²)
2	VAC in (N)	Usable wire: solid/stranded

DC Output (CON2)

#	Function	Wire cross section ⁽¹⁾
3	+Vout	26-21 AWG (0.5-1.5mm ²)
4	-Vout	Usable wire: solid/stranded

Wire stripping length: 10mm

FC= Fixing centers

Note11: Min. Wire cross section are suggested values only, and need to be aligned with the applicable safety regulation

Tolerance: xx.x= ± 0.5 mm
xx.xx= ± 0.25 mm

INSTALLATION & APPLICATION

Mounting Instruction "/PMAD-CTN" Version

Mounting Rail: Standard TS35 DIN Rail in accordance with EN 60715

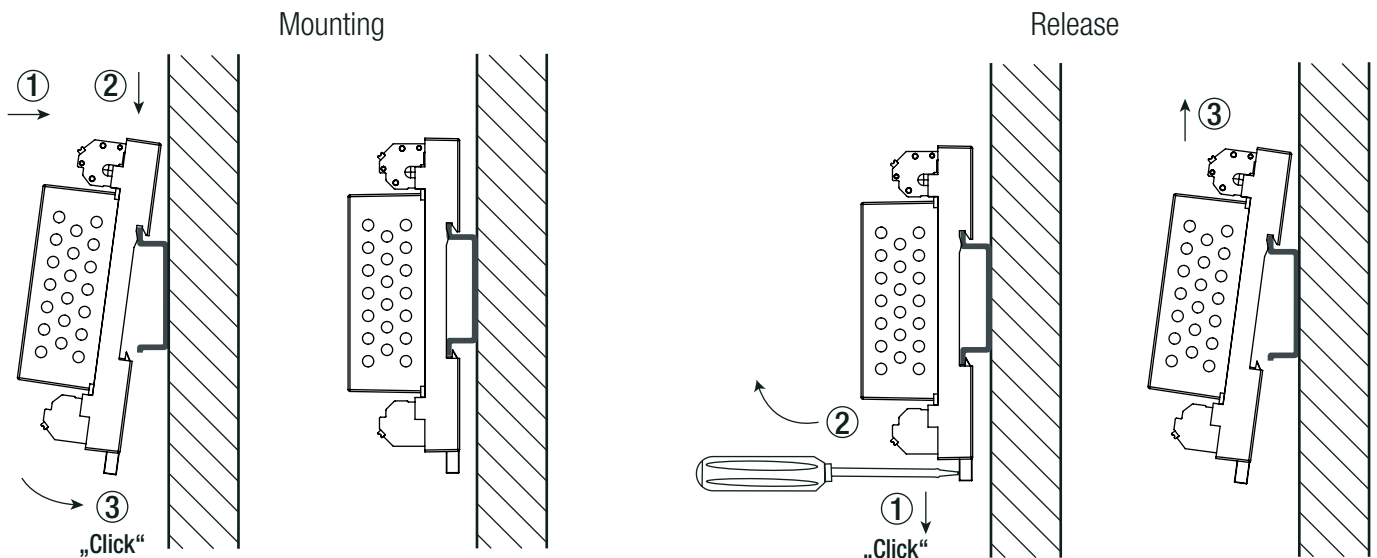

INSTALLATION & APPLICATION

Installation Instruction

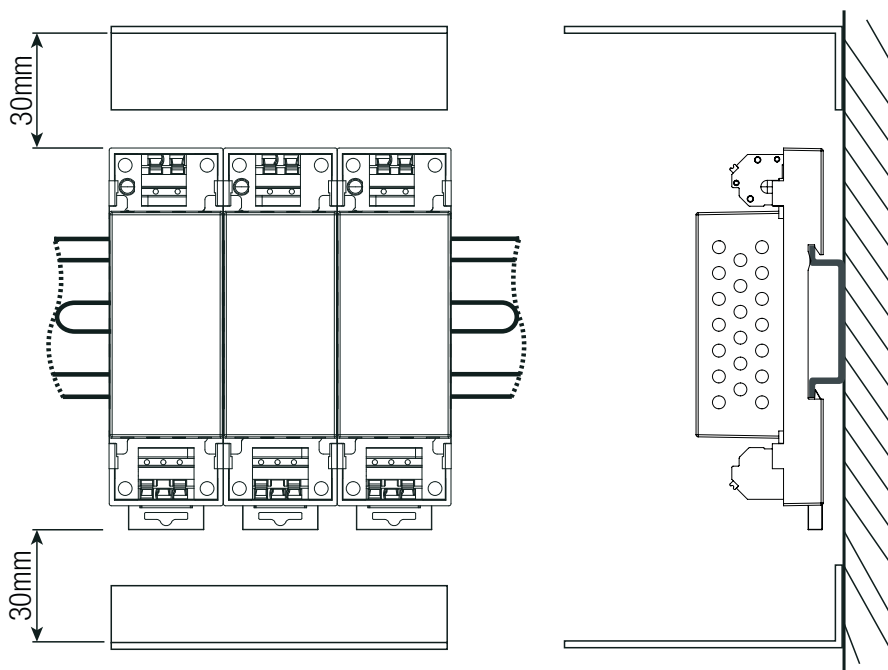

BLOCK DIAGRAM

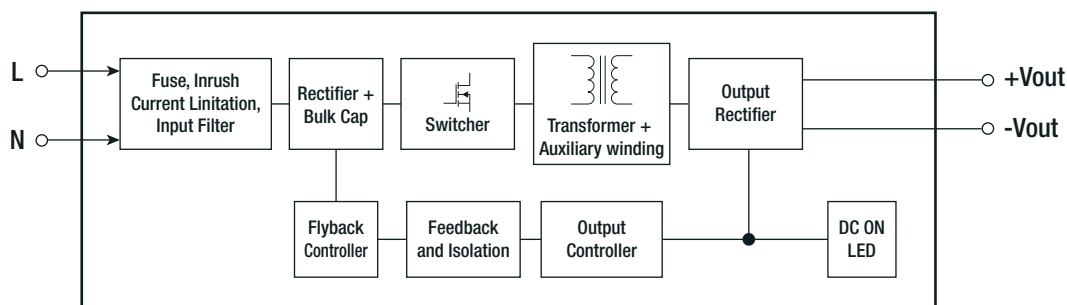

PACKAGING INFORMATION

Parameter	Type		Value
	Packaging Dimension (LxWxH)	"/OF"	tray
"/PMAD-CTN"		cardboard box (22x single pack)	96.0 x 34.0 x 40.0mm
Packaging Quantity	"/OF"		18pcs
	"/PMAD-CTN"		22pcs
Storage Temperature Range			-40°C to +90°C
Storage Humidity	non-condensing		95% RH max.

The product information and specifications may be subject to changes even without prior written notice. The product has been designed for various applications; its suitability lies in the responsibility of each customer. The products are not authorized for use in safety-critical applications without RECOM's explicit written consent. A safety-critical application is an application where a failure may reasonably be expected to endanger or cause loss of life, inflict bodily harm or damage property. The applicant shall indemnify and hold harmless RECOM, its affiliated companies and its representatives against any damage claims in connection with the unauthorized use of RECOM products in such safety-critical applications.

X-ON Electronics

Largest Supplier of Electrical and Electronic Components

Click to view similar products for [Switching Power Supplies](#) category:

Click to view products by [RECOM POWER](#) manufacturer:

Other Similar products are found below :

[70841011](#) [73-551-0005](#) [73-551-0048](#) [73-558-0015I](#) [EVS57-5R3/A](#) [FAS-002](#) [AAD600S-4-OP](#) [MS924](#) [HWS50A-5/RA](#) [KD0204](#) [9021](#)
[LDIN100150](#) [FAP-001](#) [FP80](#) [FRV7000G](#) [22929](#) [PS3E-F12F](#) [CQM1IA121](#) [LDIN5075](#) [432703037161](#) [VI-LUL-IU](#) [LPM000-BBAR-08](#)
[LPM000-BBAR-07](#) [08-30466-1055G](#) [DMB-EWG](#) [CQM1IPS01](#) [SP-300-5](#) [MAP40-S233](#) [CQM1-IPS02](#) [73-551-0024I](#) [VI-MUL-ES](#) [22829](#)
[08-30466-0028G](#) [96PSR-A460WOTH-2](#) [G06-Q01](#) [GHA300F-12-SNF](#) [MP650-2K2K](#) [MTA040009A](#) [FSA150024A](#) [VI-RUR22-EWXX](#)
[HLS30ZE-NT8](#) [UT1404-7](#) [ERP-350-12](#) [S8FSG01512C](#) [S8FSG03012C](#) [XPFM201A+](#) [S8FS-G15015C](#) [S8FS-G05005C](#) [S8FS-G03015C](#) [08-](#)
[30466-020WG](#)