

FEATURES

- Full load power: -40°C to +60°C
- Reduced load rating to 90°C
- OVC III up to 5000m and LPS
- Industry standard pinning [P12]
- Meets EN55032 “B” in PELV configuration
- Medical; household & industrial standard
- 2.0” x 1.5” encapsulated modules THT or Wired
- 3.0” x 1.5” Open Frame card
- Panel Mount and DIN-Rail Clip option
- 3 years warranty

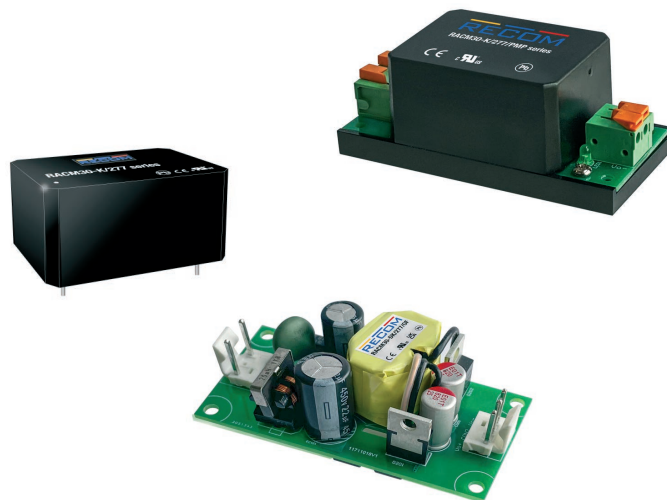

APPLICATIONS

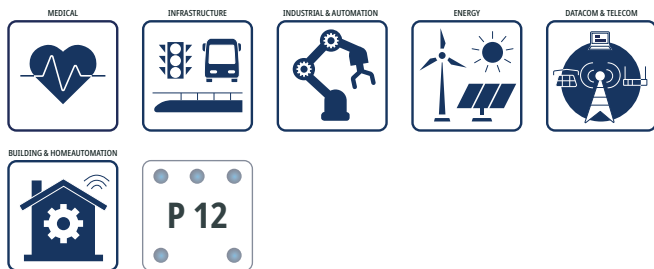

SAFETY & EMC



DESCRIPTION

RACM30-K/277 AC/DC modules provide a leading thermally effective Power yield of 9.2 Watts per inch³ at 60°C still air for continuous loads of 30 Watts plus additional peak capability. These Modules operate in a temperature range of -40° to 90°C in compliance with safety standards of medical MOPP, household-, industrial, and measurement markets. Safety reports rate the series as LPS limited power source and OVCIII for an operating altitude of up to 5000m. A comfortable margin to EMI Class B limits, even with outputs connected to the ground, ease system implementation for quick time-to-market without additional external circuitry such as fuses or filters. For designers, maximum flexibility for these encapsulated, solder-mountable modules is pin-to-pin compatible with the well-established series RAC20-K. Further mechanical derivatives are potted modules with wires or a panel mount option with spring-clamp connectors which is convertible to DIN-Rail mounting via available RECOM Clip accessory.

SELECTION GUIDE

Part Number	Input Voltage Range [VAC]	Output Voltage nom. [VDC]	Output Current max. [mA]	Efficiency typ. ⁽¹⁾ [%]	Max. Capacitive Load ⁽²⁾ [µF]
RACM30-05SK/277	85-305	5	6000	86	10000
RACM30-12SK/277	85-305	12	2500	90	10000
RACM30-15SK/277	85-305	15	2000	90	10000
RACM30-24SK/277	85-305	24	1250	89	8000
RACM30-12DK/277	85-305	±12	±1250	86	±8000
RACM30-15DK/277	85-305	±15	±1000	86	±8000

Note1: Efficiency is tested at nominal input (230VAC) and full load at +25°C ambient

Note2: Measured @ T_{AMB}= 25C°, nom. V_{IN}, full load and after warm-up unless otherwise stated

RACM30-K/277 Series / AC/DC Power Supply

30W / Universal Input 100V - 277VAC

ACCESSIBLE PART

Part Number	Description	Datasheet Link
R-DR/Clip	Din Rail mounting clip	R-DR/CLIP.pdf

MODEL NUMBERING



Note3: "/277" only = THT printmount, encapsulated, potted
 add suffix "/PMP" = panel mount version with push-in terminals
 add suffix "/PMA" = panel mount version with 45° angled push-in terminal
 add suffix "/W" for wired version (single output only), encapsulated, potted
 add suffix "/OF" = standard 38.1mm x 76.2mm (1.5"x3") open frame version with header connectors

Note4: For other case/connection/footprint options, please contact [RECOM Tech-Support](#).

ORDERING INFORMATION

Model	nom. Output Voltage	Single/Dual	Package Type Suffix				
			"THT printmount"	"/PMP"	"/PMA"	"/W"	"/OF"
RACM30-05SK/277	5	Single	x	x	coming soon	x	x
RACM30-12SK/277	12	Single	x	x	coming soon	x	x
RACM30-15SK/277	15	Single	x	N/A	x	x	x
RACM30-24SK/277	24	Single	x	x	coming soon	x	x
RACM30-12DK/277	±12	Dual	x	N/A	N/A	N/A	x
RACM30-15DK/277	±15	Dual	x	N/A	N/A	N/A	x

x= standard portfolio / on request= MOQ may apply on project base / N/A= not available

BASIC CHARACTERISTICS (measured @ T_{AMB}= 25°C, nom. V_{IN}, full load and after warm-up unless otherwise stated)

Parameter	Condition	Min.	Typ.	Max.
Nominal Input Voltage	50/60Hz	100VAC		277VAC
Operating Range ⁽⁵⁾	47-63Hz	85VAC	230VAC	305VAC
	DC	120VDC		430VDC
Input Current	115VAC			650mA
	230VAC			350mA
	277VAC			300mA
Inrush Current	cold start at 25°C	115VAC		20A
		230VAC		30A
		277VAC		36A
No Load Power Consumption	230VAC			100mW
Ecodesign Standby Mode Use (Available output power for stated input power)	V _{IN} =230VAC	P _{IN} = 0.3W		0.22W
		P _{IN} = 0.5W		0.39W
		P _{IN} = 1W		0.79W
Input Frequency Range		47Hz		63Hz
Minimum Load		0%		
Power Factor	115VAC		0.6	
	230VAC		0.5	
	277VAC		0.45	
Start-up time				150ms
Rise time				30ms
Hold-up time	230VAC	50ms		
Internal Operating Frequency	100% load at nominal V _{IN}			100kHz
Output Ripple and Noise ⁽⁶⁾	20MHz BW			100mVp-p

Note5: The products were submitted for safety files at AC-Input operation, and to IEC/EN61010-1 for DC-operation

Note6: Measurements are made with a 0.1µF MLCC & 10µF E-cap in parallel across output. (low ESR)

BASIC CHARACTERISTICS (measured @ $T_{AMB} = 25^{\circ}C$, nom. V_{IN} , full load and after warm-up unless otherwise stated)

RACM30-05SK/277 & RACM30-24SK/277

Efficiency vs. Load

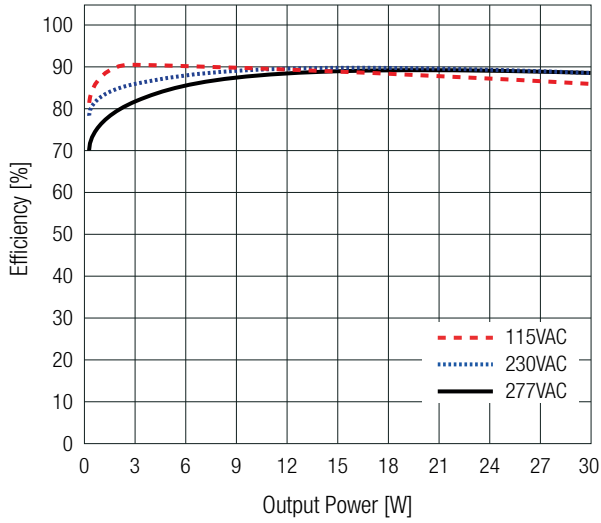

Power Dissipation vs. Load

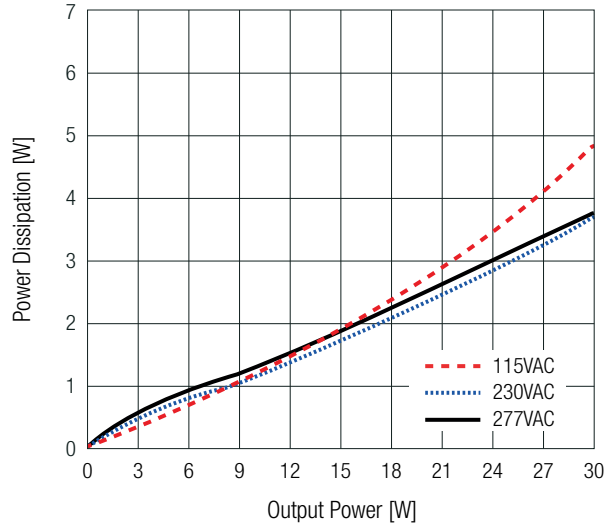

RACM30-12SK/277; RACM30-15SK/277

Efficiency vs. Load

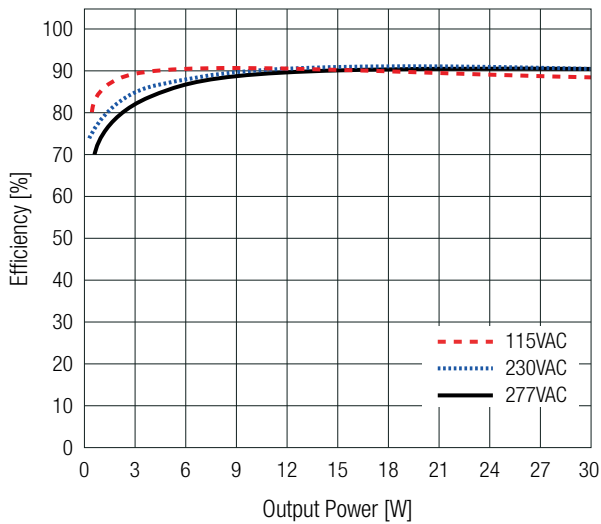

Power Dissipation vs. Load

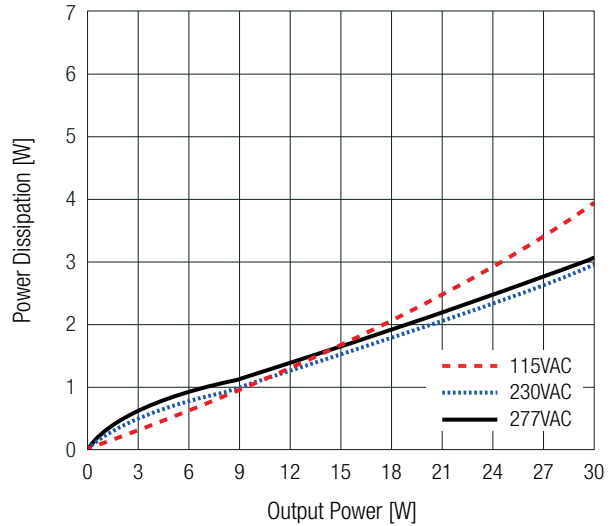

RACM30-12DK/277; RACM30-15DK/277

Efficiency vs. Load

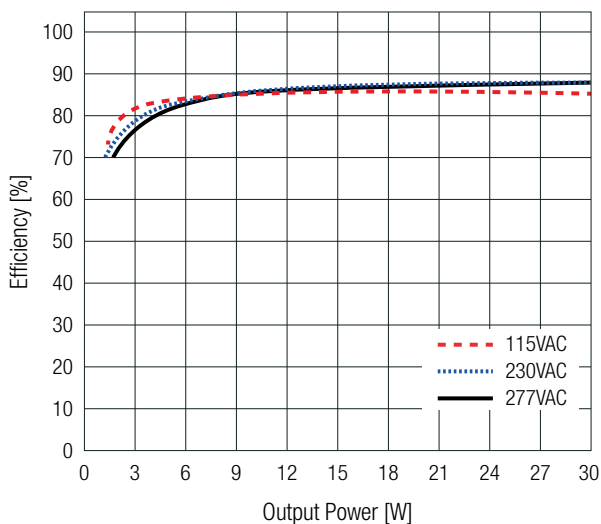

Power Dissipation vs. Load

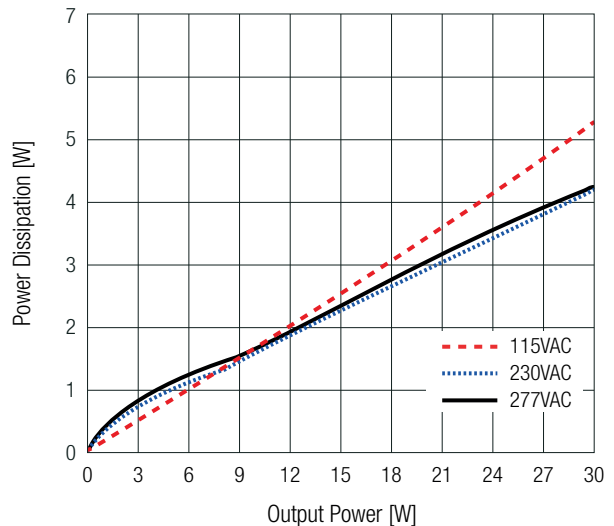

RACM30-K/277 Series / AC/DC Power Supply

30W / Universal Input 100V - 277VAC

REGULATIONS (measured @ $T_{AMB}=25^{\circ}\text{C}$, nom. V_{IN} , full load and after warm-up unless otherwise stated)

Parameter	Condition		Value
Output Accuracy	single output		$\pm 2.0\%$ typ.
	dual output		$\pm 3.0\%$ typ.
Line Regulation	low line to high line	$5V_{OUT}$	$\pm 1.0\%$ typ.
		others	$\pm 0.5\%$ typ.
Load Regulation ⁽⁷⁾	10% to 100% load	$5V_{OUT}$	3.0% typ.
		others	1.0% typ.
Cross Regulation	dual output only		$\pm 10.0\%$ typ.
Transient Response	25% load step change		4.0% max.
	recovery time		500 μs typ.

Note7: Operation below 10% load will not harm the converter, but specifications may not be met

PROTECTIONS (measured @ $T_{AMB}=25^{\circ}\text{C}$, nom. V_{IN} , full load and after warm-up unless otherwise stated)

Parameter	Type		Value
Input Fuse ⁽⁸⁾			T3.15A, slow blow type
Short Circuit Protection (SCP)			hiccup, auto recovery
Over Voltage Protection (OVP)			150% - 195%, hiccup mode
Over Current Protection (OCP)			<180%, hiccup mode
Over Voltage Category (OVC)	"/THT printmount"; "/W"; "/PMP"; "/PMA"		OVCIII (5000m)
	"/OF"		OVCIII (3000m) / OVCII (5000m)
DC ON LED	only for "/PMP" and "/PMA"		green
Class of Equipment			Class II
Isolation Voltage ⁽⁹⁾	I/P to O/P, I/P to case, O/P to case	1 minute	4kVAC
Isolation Resistance	$V_{ISO} = 500\text{VDC}$		1G Ω min.
Isolation Capacitance	I/P to O/P, 100kHz/0.1V		100pF max.
Insulation Grade	I/P to O/P		reinforced
Means of Protection	I/P to O/P		2MOPP
Medical Device Classification	built-in power supply		BF ready
Touch Current			100 μA max.

Note8: For system integration with DC operation, consider a suitable DC fuse in front of the input

Note9: For repeat Hi-Pot testing, reduce the time and/or the test voltage

ENVIRONMENTAL (measured @ $T_{AMB}=25^{\circ}\text{C}$, nom. V_{IN} , full load and after warm-up unless otherwise stated)

Parameter	Condition		Value
Operating Ambient Temperature Range	@ natural convection (0.1m/s)	refer to „Derating Graph“	-40 $^{\circ}\text{C}$ to +90 $^{\circ}\text{C}$
Maximum Case Temperature			+110 $^{\circ}\text{C}$
Temperature Coefficient			0.02%/K
Operating Altitude ⁽¹⁰⁾	according to 62368-1, 60601-1, 61558		5000m
Operating Humidity	non-condensing		90% RH max.
Pollution Degree	"/THT printmount"; "/W"; "/PMP"; "/PMA"		PD3
	"/OF"		PD2
Vibration	according to MIL-STD-202G		10-500Hz, 2G 10min./1cycle, period 60min. each along x,y,z axes
	"/THT printmount" types only	according to IEC 60068-2-27	3 axis, 40 g half sine, 11 ms shock
		according to IEC 60068-2-65	5-500Hz, 20m/s ² , 1 Oct/min, 15min
		according to IEC 60068-2-64	10-500Hz; RMS 23,4m/s ² ; 15min

RACM30-K/277 Series / AC/DC Power Supply

30W / Universal Input 100V - 277VAC

ENVIRONMENTAL (measured @ $T_{AMB}=25^{\circ}\text{C}$, nom. V_{IN} , full load and after warm-up unless otherwise stated)

Parameter	Condition			Value	
MTBF	according to MIL-HDBK-217, G.B.	"/THT printmount"; "/W"; "/PMP"; "/PMA"	+25°C	>1357 x 10 ³ hours	
			+40°C	>1096 x 10 ³ hours	
		"/OF"	+25°C	>1115 x 10 ³ hours	
			+40°C	>873 x 10 ³ hours	
Design Lifetime	230VAC/50Hz and full load	"/THT printmount"; "/W"; "/PMP"; "/PMA"	single output	5V _{OUT} +45°C	>30 x 10 ³ hours
				others +50°C	>30 x 10 ³ hours
		dual output	+40°C	>30 x 10 ³ hours	
			+50°C	>17 x 10 ³ hours	
		"/OF"	+50°C	>30 x 10 ³ hours	

Note10: Recognized by safety agency for safe operation up to 5000m. High altitude operation may impact the performance and lifetime.

Derating Graph

(@ Chamber and natural convection 0.1m/s)

RACM30-05SK/277 (/W; /PMP; /PMA)

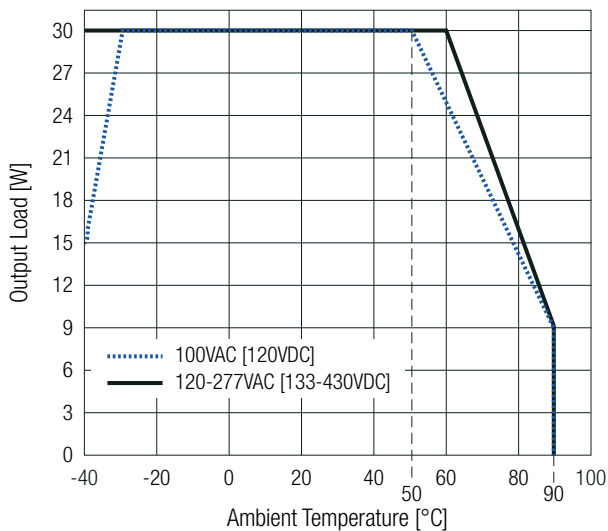

RACM30-xxS(D)K/277 (/W; /PMP; /PMA) others

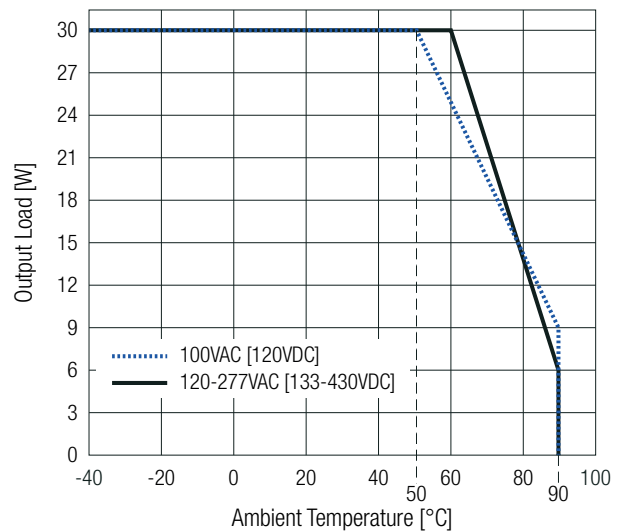

RACM30-05SK/277/OF

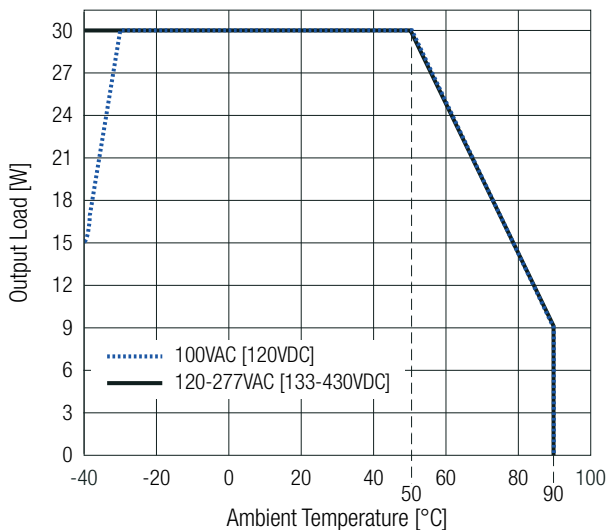

RACM30-xxSK/277/OF others

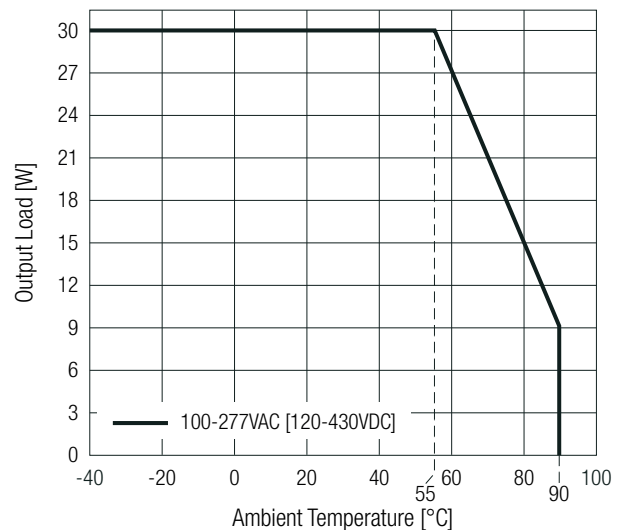

Specifications (measured @ Ta= 25°C, nom. Vin, full load and after warm-up unless otherwise stated)

Derating Graph

(@ Chamber and natural convection 0.1m/s)

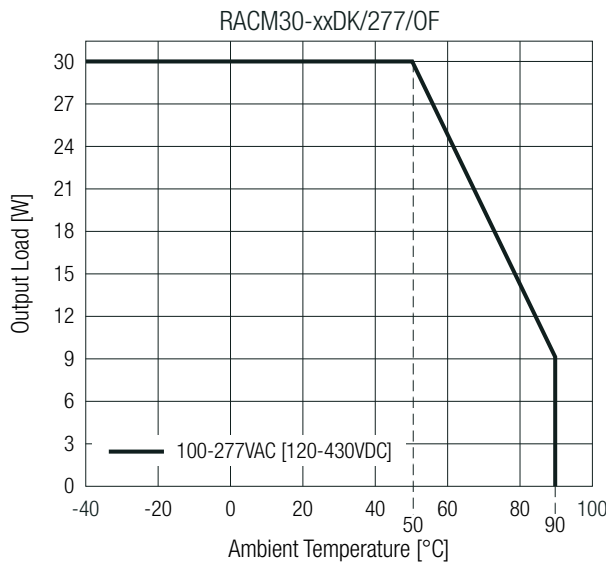

PEAK LOAD CAPABILITY (SINGLE OUTPUT ONLY)

Calculation:

- P_p = peak output power [W]
- P_r = recovery output power [W]
- t₁ = peak time set (10s max.) [s]
- t₂ = recovery time (min. 5 x t₁) [s]
- k = safety factor 1.1 []

Maximum Peak Power

nom. V _{OUT} = 5VDC	nom. V _{OUT} = 15VDC
nom. V _{OUT} = 12VDC	nom. V _{OUT} = 24VDC
33W	36W

$$P_r = \frac{30 \times (t_1 + t_2) - (P_p \times t_1)}{t_2 \times k}$$

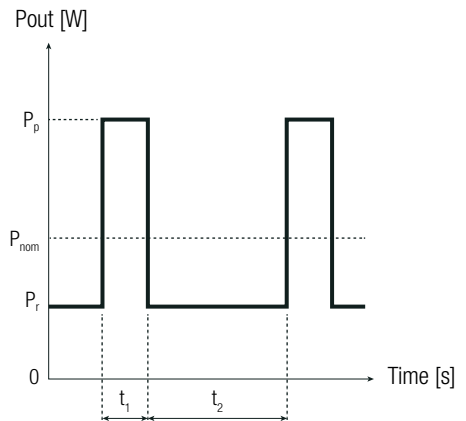

Practical Example (RACM30-24SK/277):

Take the RACM30-24SK/277 at 230VAC input and full load at T_{AMB}= 25°C, with natural convection.

- P_p = 36W
- t₁ = 10s
- t₂ = 50s
- k = 1.1

$$P_r = \frac{30 \times (10 + 50) - (36 \times 10)}{50 \times 1.1} = 26.2W$$

SAFETY & CERTIFICATIONS

Certificate Type (Safety)	Report Number	Standard
Audio/Video, information and communication technology equipment - Part1: Safety requirements	64.210.22.02737.01	EN62368-1:2014+A11:2017 (2nd Edition)
Audio/Video, information and communication technology equipment - Safety requirements (CB)	085-220273601-100	IEC62368-1:2018 (3rd Edition)
Audio/Video, information and communication technology equipment - Safety requirements (LVD)	64.210.22.02737.02 (except open frame /OF)	EN62368-1:2020+A11:2020 (3rd Edition)
Electrical Equipment For Measurement, Control, and Laboratory Use; Part 1: General Requirements (CB)	085-220277601-000 (/OF models pending)	IEC61010-1:2010+A1:2016 3rd Edition with IEC61010-2-201:2017
Electrical Equipment For Measurement, Control, and Laboratory Use; Part 1: General Requirements (LVD)	64.240.22.02776.01 (/OF models pending)	EN61010-1:2010+A1:2019 with EN IEC 61010-2-201:2018
Medical electrical equipment Part 1: General requirements for basic safety and essential performance (CB)	22SBDS06094-02771	IEC60601-1:2005+AM1:2012 3rd Edition
Medical electrical equipment Part 1: General requirements for basic safety and essential performance (LVD)		EN60601-1:2006+A1:2013+AC:2014
Medical electrical equipment Part 1: General requirements for basic safety and essential performance	E314885	ANSI/AAMI ES60601-1:2005+A2:2010/(R)2012 CAN/CSA-C22.2 No. 60601-1:14 3rd Edition

SAFETY & CERTIFICATIONS

Certificate Type (Safety)	Report Number	Standard
Household and similar electrical appliances – Safety – Part 1: General requirements (CB)	64.260.22.02739.01	IEC60335-1:2010+C1:2016 5th Edition
Household and similar electrical appliances – Safety – Part 1: General requirements (LVD)		EN60335-1:2012+A2:2019+A15:2021
Measurement methods for electromagnetic fields of household appliances and similar apparatus with regard to human exposure		EN62233:2008
Safety of power transformers, power supplies, reactors & similar products for supply voltages up to 1100V	085-220273801-000	IEC61558-1:2017 3rd Edition
Safety of power transformers, power supplies, reactors & similar products for supply voltages up to 1100V Part 2: Particular requirements		IEC61558-2-16:2009+A1:2013 1st Edition
Safety of power transformers, power supplies, reactors & similar products for supply voltages up to 1100V	64.250.22.02738.01	EN IEC 61558-1:2019
Safety of power transformers, power supplies, reactors & similar products for supply voltages up to 1100V Part 2: Particular requirements		EN61558-2-16:2009+A1:2013
RoHS2		RoHS-2011/65/EU + AM-2015/863

EMC Compliance according to EN60601-1-2	Condition	Standard / Criterion
Medical electrical equipment Part 1-2: General requirements for basic safety and essential performance		EN60601-1-2:2015+A1:2021, Class B
ESD Electrostatic discharge immunity test	Air: $\pm 2, 4, 8, 15\text{kV}$ Contact $\pm 8\text{kV}$	EN61000-4-2:2008 IEC61000-4-2:2009
Radiated, radio-frequency, electromagnetic field immunity test	10V/m (80-2700MHz); table 9	IEC/EN61000-4-3:2006 + A2:2010
Fast Transient and Burst Immunity	L-N: $\pm 2\text{kV}$	IEC/EN61000-4-4:2012
Surge Immunity	L-N: $\pm 0.5, 1, 2\text{kV}$	IEC/EN61000-4-5:2014 + A1:2017
Immunity to conducted disturbances, induced by radio-frequency fields	3Vrms (0.15-80MHz); 6Vrms (ISM and amateur radio bands within 0.15-80MHz)	IEC61000-4-6:2013 EN61000-4-6:2014
Power Magnetic Field Immunity	30A/m	EN61000-4-8:2010
Voltage Dips and Interruptions	Dips: 100% (0.5P, 1.0P); 30% (25P/30P) Interruption: 100% (250P/300P)	EN61000-4-11:2004 + A1:2017

SAFETY & CERTIFICATIONS

EMC Compliance according to EN35032/EN35035	Condition	Standard / Criterion
Electromagnetic compatibility of multimedia equipment – Emission Requirements		EN55032:2015, Class B
Electromagnetic compatibility of multimedia equipment – Immunity requirements		EN55035:2017+A11:2020
Radiated, radio-frequency, electromagnetic field immunity test	3V/m (1800, 2600, 3500, 5000MHz)	IEC/EN61000-4-3:2006 + A2:2010, Criteria A
Fast Transient and Burst Immunity	L, N, L-N: 2kV DC load line: 0.5kV	IEC/EN61000-4-4:2012, Criteria A

EMC Compliance according to EN IEC61204-1	Condition	Standard / Criterion
Low voltage power supplies, d.c. output Part 3: Electromagnetic compatibility		EN IEC 61204-3:2018
ESD Electrostatic discharge immunity test	Air: $\pm 2, 4, 8\text{kV}$ Contact $\pm 4\text{kV}$	EN61000-4-2:2008, Criteria A IEC61000-4-2:2009, Criteria A
Radiated, radio-frequency, electromagnetic field immunity test	10V/m (80-1000MHz); 3V/m (1400-2000MHz); 1V/m (2000-2700MHz)	IEC/EN61000-4-3:2006+A2:2010, Criteria A
Fast Transient and Burst Immunity	L-N: $\pm 2\text{kV}$	IEC/EN61000-4-4:2012, Criteria B
Surge Immunity	L-N: $\pm 0.5, 1, 2\text{kV}$	IEC/EN61000-4-5:2014+A1:2017, Criteria A
Immunity to conducted disturbances, induced by radio-frequency fields	10Vrms (0.15-80MHz)	IEC61000-4-6:2013, Criteria A EN61000-4-6:2014, Criteria A
Power Magnetic Field Immunity	30A/m	IEC61000-4-8:2009, Criteria A EN61000-4-8:2010, Criteria A

RACM30-K/277 Series / AC/DC Power Supply

30W / Universal Input 100V - 277VAC

SAFETY & CERTIFICATIONS

Voltage Dips	100% (0.5P, 1.0P); 20% (250P/300P); 30% (25P/30P)	IEC/EN61000-4-11:2004 + A1:2017, Criteria A
Voltage Interruptions	100% (250P/300P)	IEC/EN61000-4-11:2004 + A1:2017, Criteria B
Limits of Harmonic Current Emissions	N/A (<75W)	EN IEC 61000-3-2:2019
Limits of Voltage Fluctuations & Flicker		EN61000-3-3:2013+A1:2019
EMC Compliance according to EN55014-1/EN55014-2		
	Condition	Standard / Criterion
Electromagnetic compatibility of household appliances, electric tools and similar apparatus - Emission Requirements		EN55014-1:2006 + A2:2011
Electromagnetic compatibility of household appliances, electric tools and similar apparatus - Immunity Requirements		EN55014-2:2015
Immunity to conducted disturbances, induced by radio-frequency fields	3Vrms (0.15-230MHz)	IEC61000-4-6:2013, Criteria A EN61000-4-6:2014, Criteria A

DIMENSION & PHYSICAL CHARACTERISTICS

Parameter	Type	Value
Materials	case/baseplate	plastic, (UL94-V0)
	potting	PU, (UL94-V0)
	PCB	FR4, (UL94-V0)
Dimension (LxWxH)	"/THT printmount"; "/W"	52.5 x 40.0 x 25.5mm 2.0 x 1.5 x 1.0 inch
	"/PMP"; "/PMA"	84.7 x 40.0 x 33.0mm 3.3 x 1.5 x 1.3 inch
	"/OF" Single output; "/OF" Dual output	76.2 x 38.1 x 25.0mm 3.0 x 1.5 x 0.98 inch
Weight	"/THT printmount"	93g / 0.21 lbs
	"/PMP"; "/PMA"	122g / 0.27 lbs
	"/W" type including wires	98g / 0.22 lbs
	"/OF"	49g / 0.11 lbs

DIMENSION & PHYSICAL CHARACTERISTICS

Dimension Drawing "THT printmount" version SINGLE and DUAL Output (mm)

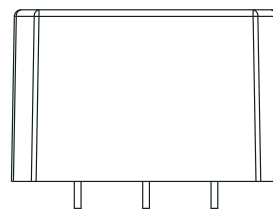
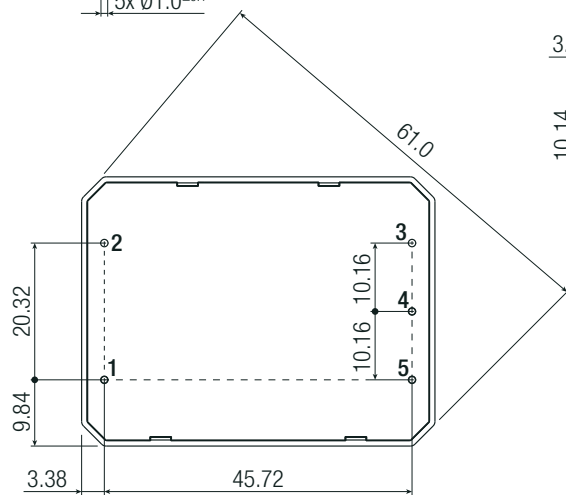
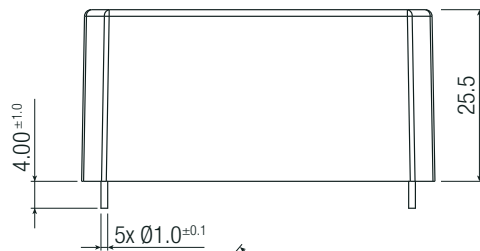
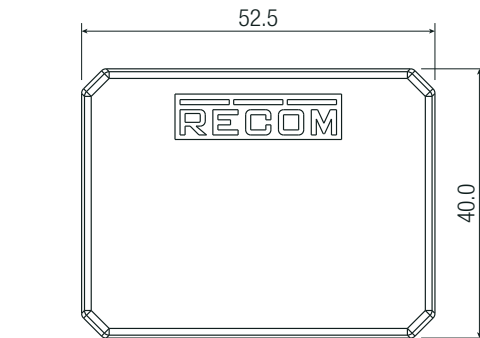
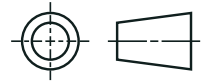

Recommended Footprint Details (Top View)

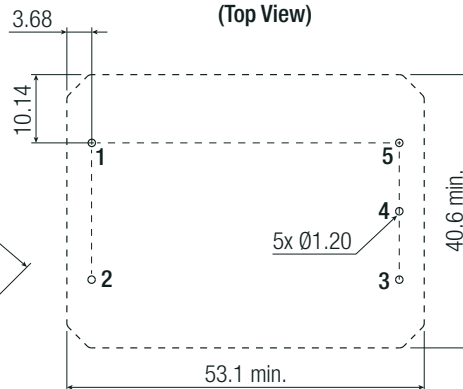

Pinning information [P12]

Pin #	Single	Dual
1	VAC in (N)	VAC in (N)
2	VAC in (L)	VAC in (L)
3	no pin	-Vout
4	-Vout	Com
5	+Vout	+Vout

Dimension Drawing Wired version "/W" SINGLE Output (mm)

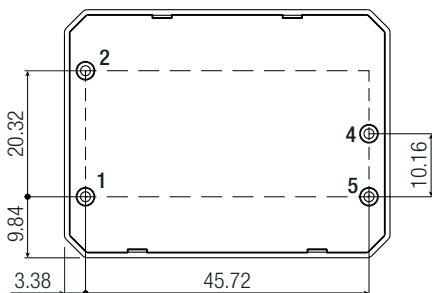
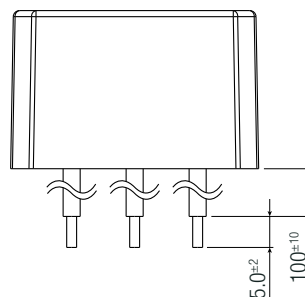
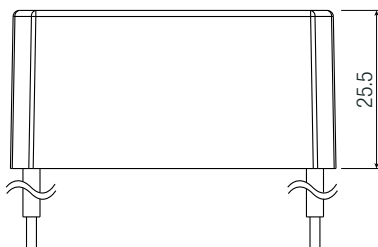

Wire information

#	Function	Wire color	Type	AWG
1	VAC in (N)	blue	UL-1015	18
2	VAC in (L)	brown	UL-1015	18
4	-Vout	black	UL-1015	18
5	+Vout	red	UL-1015	18

Tolerance:
 x.x= ±0.5mm
 x.xx= ±0.25mm

DIMENSION & PHYSICAL CHARACTERISTICS

Dimension Drawing Open Frame "OF" SINGLE Output (mm)

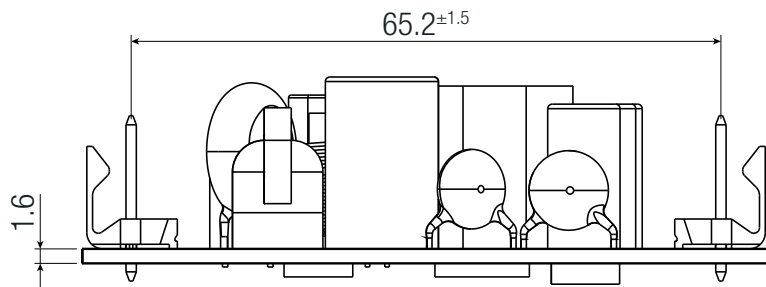
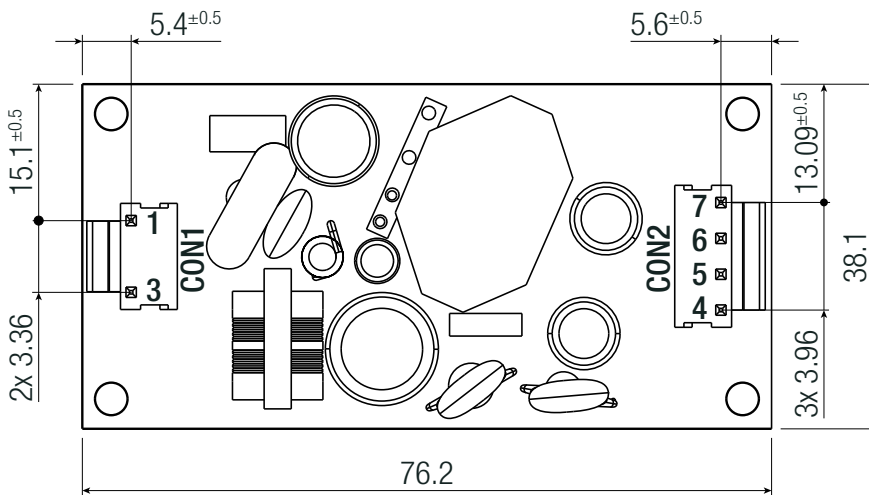

Connector Information - SINGLE

#	Function	Terminal
AC Input (CON1)		
1	Vin (L)	Molex 26-62-4030
3	Vin (N)	(Pin2 removed)
DC Output Connector (CON2)		
4, 5	+Vout	Molex 26-60-4040
6, 7	-Vout	

FC= fixing centers

Compatible Connector

Housing

Molex 41695 Series or equivalent

Crimp Terminal

Molex 2478 Series or equivalent

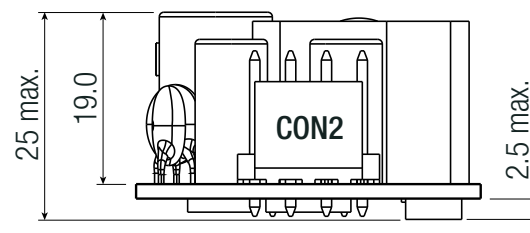
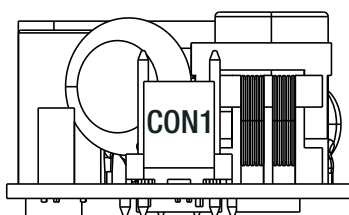
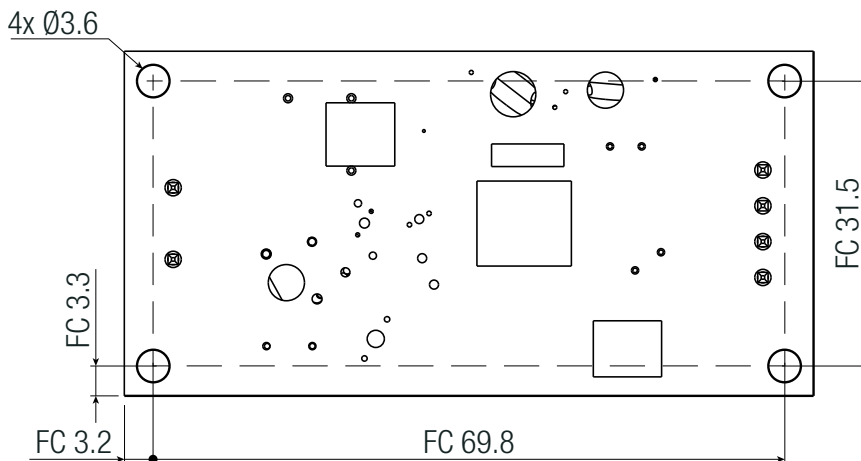

Tolerance:
 x.x= ±0.5mm
 x.xx= ±0.25mm

DIMENSION & PHYSICAL CHARACTERISTICS

Dimension Drawing Open Frame "/OF" DUAL Output (mm)

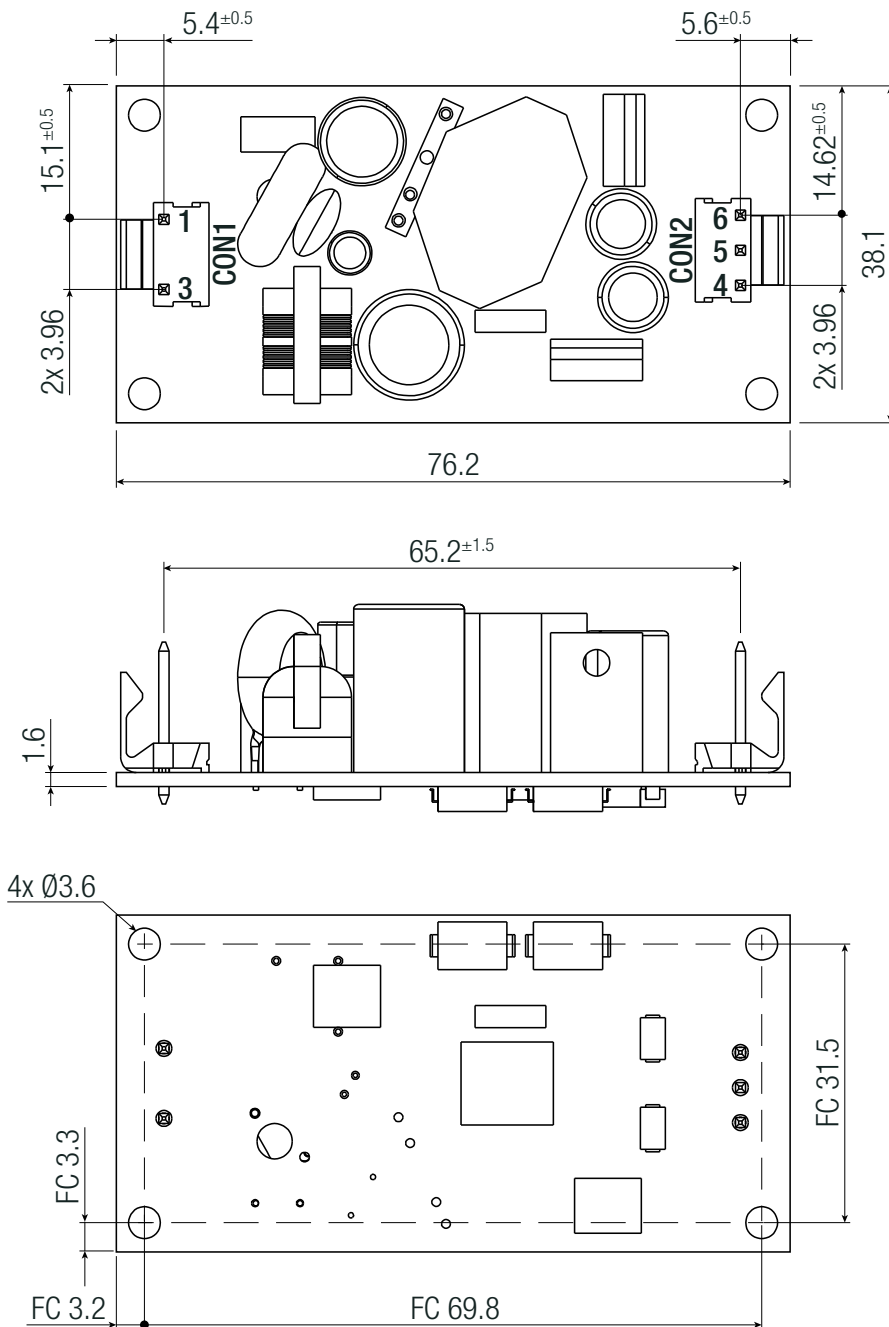

Connector Information - DUAL

#	Function	Terminal
AC Input (CON1)		
1	Vin (L)	Molex 26-62-4030
3	Vin (N)	(Pin2 removed)
DC Output Connector (CON2)		
4	+Vout	
5	Com	Molex 26-60-4030
6	-Vout	

FC= fixing centers

Compatible Connector

Housing

Molex 41695 Series or equivalent

Crimp Terminal

Molex 2478 Series or equivalent

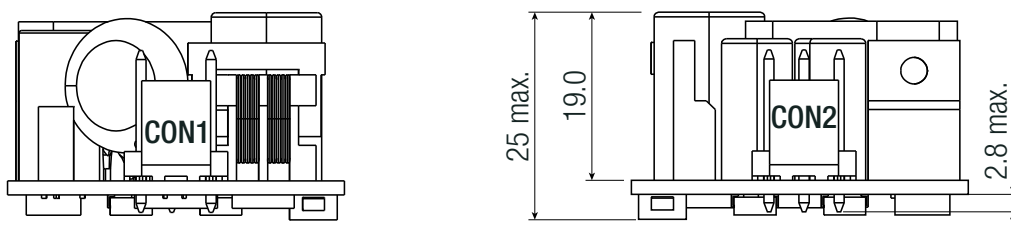

Tolerance:
 x.x= ±0.5mm
 x.xx= ±0.25mm

DIMENSION & PHYSICAL CHARACTERISTICS

Dimension Drawing Panel Mount “/PMP” SINGLE Output (mm)

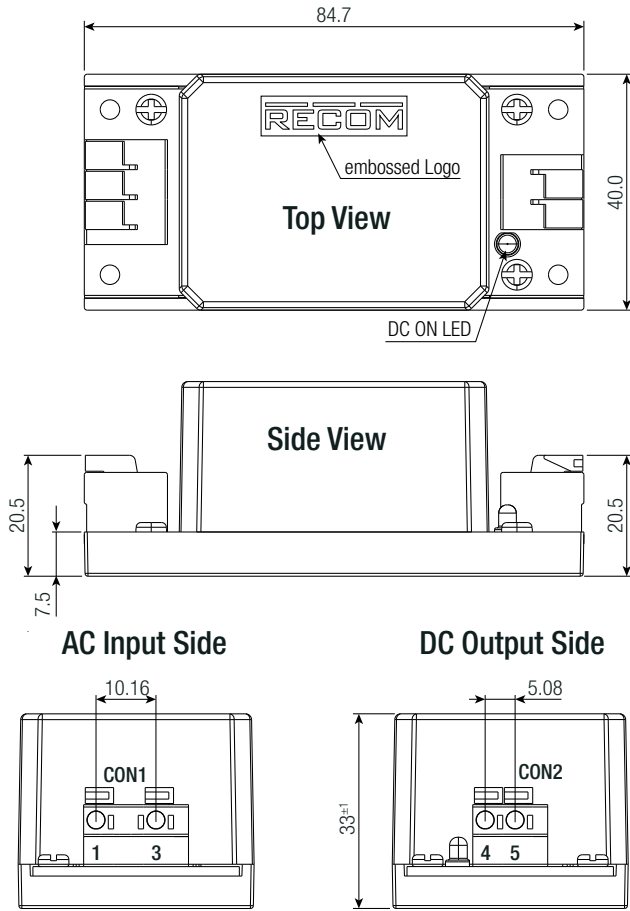

Dimension Drawing Panel Mount “/PMA” SINGLE Output (mm)

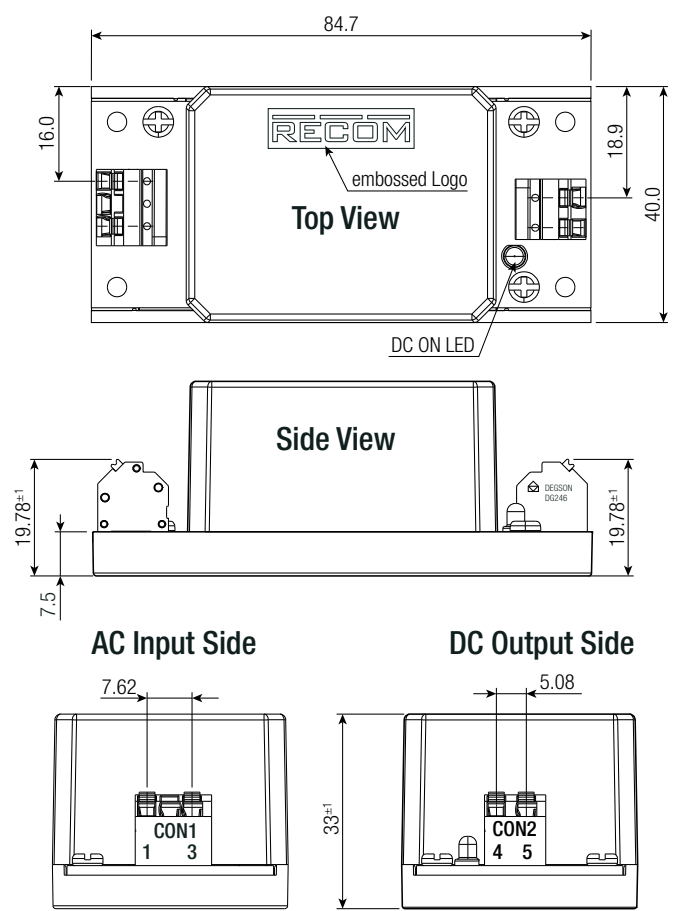

Push-In Spring Terminal

#	Function	Pitch	Terminal Information
AC Input (CON1)			
1	VAC in (L)	10.16mm pitch	Degson
3	VAC in (N)	pin2 removed	(DG142R-5.08-03P-2Y)
DC Output (CON2)			
4	+Vout	2 pins	Degson
5	-Vout	5.08mm pitch	(DG142R-5.08-02P-2Y)

Wire stripping length: 11mm
 Wire cross section: 22-16AWG (0.2-1.5mm²)
 Usable wire cable: Solid and stranded
 FC= fixing centers

Push-In Spring Terminal

#	Function	Terminal	Terminal Information
AC Input (CON1)			
1	VAC in (L)	7.62mm pitch	Degson
3	VAC in (N)	pin2 removed	(DG246-3.81-02P-24)
DC Output Connector (CON2)			
4	-Vout	2pins	Degson
5	+Vout	5.08mm pitch	(DG246-5.08-02P-14)

Wire stripping length: 10mm
 Wire cross section: 22-16AWG (0.2-1.5mm²)
 Usable wire cable: Solid and stranded
 FC= fixing centers

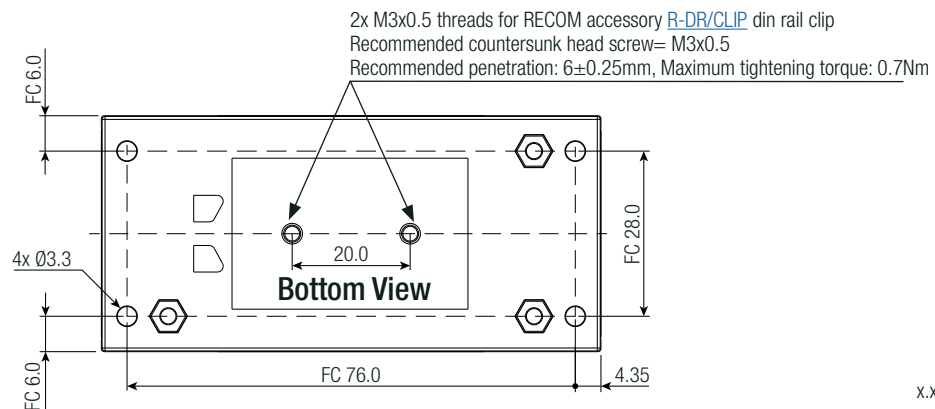

Tolerance:
 x.x= ±0.5mm
 x.xx=0.25mm

INSTALLATION AND APPLICATION

Dimension Drawing RACM30-K/277/PMP after conversion with the RECOM Din Rail Clip "R-DR/CLIP" accessory part

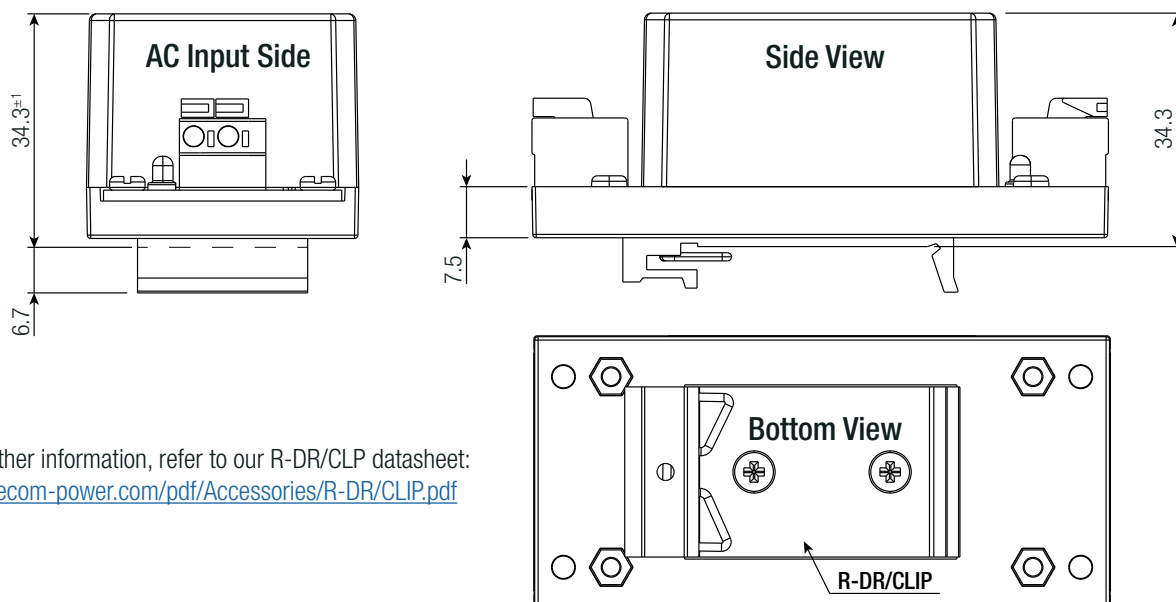

For further information, refer to our R-DR/CLP datasheet:
www.recom-power.com/pdf/Accessories/R-DR/CLIP.pdf

PACKAGING INFORMATION

Parameter	Type		Value
Packaging Dimension (LxWxH)	tube	"/THT printmount"	490.0 x 56.0 x 40.0mm
	tray	"/W"; "/PMP"; "/PMA"	405.0 x 360.0 x 55.0mm
		"/OF"	360.0 x 205.0 x 50.0mm
Packaging Quantity	"/THT printmount"		11pcs
	"/W"; "/PMP"; "/PMA"		24pcs
	"/OF"		12pcs
Storage Temperature Range			-40°C to +90°C
Storage Humidity	non-condensing		95% RH max.

The product information and specifications may be subject to changes even without prior written notice. The product has been designed for various applications; its suitability lies in the responsibility of each customer. The products are not authorized for use in safety-critical applications without RECOM's explicit written consent. A safety-critical application is an application where a failure may reasonably be expected to endanger or cause loss of life, inflict bodily harm or damage property. The applicant shall indemnify and hold harmless RECOM, its affiliated companies and its representatives against any damage claims in connection with the unauthorized use of RECOM products in such safety-critical applications.

X-ON Electronics

Largest Supplier of Electrical and Electronic Components

Click to view similar products for [AC/DC Power Modules](#) category:

Click to view products by [RECOM POWER](#) manufacturer:

Other Similar products are found below :

[HP01S0500WI](#) [HP01S1200WI](#) [HP01S2400WI](#) [HP03S1200WJ](#) [HP03S2400WJ](#) [ZP03S1200WE](#) [ZP05S2400WB](#) [AMEOF550-24SHAMJZ-FB](#)
[AMEOF550-48SHAMJZ-FB](#) [AMEOFL10-3S480PEVZ-B](#) [AMEOFL10-9S480PEVZ-B](#) [AMEOFL5-3S480HANZ-B](#) [AMEOFL5-9S480HANZ-B](#) [HP02S1200WI](#) [AME30-9S480JZ-B](#) [AME30-3S480JZ-B](#) [ZP05S1800WB](#) [ZP10S2400W](#) [ZP03S0500WE](#) [AMEOF450-48SHAMJZ-FB](#) [AMEL15-3S277HAVZ-B](#) [AME30-48S480JZ-B](#) [AME30-15S480JZ-B](#) [CFM36SB480-T](#) [EZAC-R11-QE8](#) [17000-0455](#)
[CFM70S240-E](#) [CFM36SB050](#) [CFM50S120-E](#) [RACM30-15SK/277/W](#) [CFM70S480-E](#) [RACM30-15DK/277](#) [CFM36SB150](#) [CFM36SB150-T](#)
[RACM16E-05SK/277](#) [CFM50S480-E](#) [CFM50S050-E](#) [17000-0458](#) [CFM20S150](#) [TAD20-15-WH](#) [RACM30-24SK/277/W](#) [RACM30-05SK/277](#) [CFM70S150-E](#) [CFM04S033-T](#) [CFM50S150-E](#) [CFM70S050-E](#) [17000-0457](#) [AMEOF550-36SHAMJZ](#) [ZPL15S2400WL](#) [AMEL10-5S277HAVZ](#)