

Features

Power Module

- Non-isolated buck/boost converter
- Up to 3000W in half brick case
- Adjustable output voltage and current
- Efficiency up to 96%
- Wide operating temperature range from -40°C to +85°C without derating
- IEC/EN62368-1 certified

RECOM
DC/DC Converter

RBBA3000

50 Amp Half Brick Buck/Boost converter



Description

The RBBA3000 is a high efficiency non-isolated buck/boost converter with up to 50A output current in a half-brick case. The input voltage range is from 9-60VDC and the output voltage (0-60V) and current (0-50A) are independently set via fixed trim resistors or an external voltage. The I_{share} pin has two functions: it can be used to monitor the load current in stand-alone applications or it can be used to connect two modules in parallel to double the maximum output current to 100A. Typical applications are 48V to 24V or 12V to 24V battery power conversion, electric vehicles, battery voltage stabilizers or high power laboratory DC power supplies. With appropriate cooling, the full power operating temperature extends from -40°C to +85°C and the RBBA3000-50 comes with RECOM's standard 2 year warranty.

Selection Guide

| Part Number | Input Voltage Range [VDC] | Input Current max. [A] | Nom. Output Voltage [VDC] | Output Current max. [A] | Efficiency typ. ⁽¹⁾ [%] |
|-------------|---------------------------|------------------------|---------------------------|-------------------------|------------------------------------|
| RBBA3000-50 | 9 - 60 | 50 | 0 - 60 | 50 | 96 |

Notes:

Note1: Efficiency is tested at nominal input and 24Vout at +25°C ambient

Model Numbering

RBBA3000-50

└── max. Output Current

IEC/EN62368-1 certified
EN55032 compliant
CB Report

Specifications (measured @ Ta= 25°C, 2.5m/s, nom. Vin, 24Vout and after warm-up unless otherwise stated)

| BASIC CHARACTERISTICS | | | | | |
|--|---|--|------|------------------------|---------|
| Parameter | Condition | | Min. | Typ. | Max. |
| Internal Input Filter | | | | | Pi-Type |
| Input Voltage Range ⁽²⁾ | nom. Vin = 48VDC | | 9VDC | | 60VDC |
| Absolute Maximum Input Voltage | 100ms | | | | 80VDC |
| Undervoltage Lockout Threshold | DC-DC ON | | 7VDC | 8VDC | 9VDC |
| | DC-DC OFF | | 5VDC | 6VDC | 7VDC |
| Undervoltage Lockout Hysteresis | | | | 2VDC | |
| Input Current ⁽³⁾ | low line to high line | | | | 50A |
| Quiescent Current | no load Vin = 24VDC | Vout = 12VDC Vout = 24VDC Vout = 48VDC | | 100mA 90mA 180mA | |
| Internal Power Dissipation | refer to „Power Dissipation vs. Output Current“ | | | | |
| Output Current Range ⁽²⁾ | | | 0A | | 50A |
| Output Voltage Trimming ⁽⁴⁾ | | | 0VDC | | 60VDC |

Notes:

Note2: For detail information please refer to “Safe Operating Area”

Note3: For detail information please refer to “PROTECTIONS”

Note4: For detail information please refer to “Output Voltage Trimming”

continued on next page

Specifications (measured @ Ta= 25°C, 2.5m/s, nom. Vin, 24Vout and after warm-up unless otherwise stated)

| Parameter | Condition | | Min. | Typ. | Max. |
|--|--|-----------------------|---|------------------|---------|
| Minimum Load | | | 0% | | |
| Start-up time | ON/OFF CTRL Power Up | | | 30ms 30ms | |
| Rise Time | | | | 300mV/ms | |
| ON/OFF CTRL ⁽⁵⁾ | nom. Vin= 48VDC | DC-DC ON DC-DC OFF | 0VDC <V _{CTRL} <0.8VDC 3.5VDC <V _{CTRL} <10VDC | | |
| Input Current of CTRL Pin | nom. Vin= 48VDC | | | 1mA | |
| Standby Current | nom. Vin= 48VDC | DC-DC OFF | | 2mA | |
| Current Monitor or Current Share <i>"Ishare"</i> | reference voltage at no load reference voltage at full load (50A) | | | 0.2VDC 2.7VDC | |
| Internal Operating Frequency | | | 100kHz | 280kHz | 400kHz |
| Output Ripple and Noise ⁽⁶⁾ | 20MHz BW | | | 100mVp-p | |
| Absolute Maximum Capacitive Load | <1 second start up | | | | 15000µF |

Notes:

Note5: The ON/OFF CTRL is normally OFF

Note6: Measurements are made with a 100µF E-Cap across output (low ESR)

Efficiency vs. Load

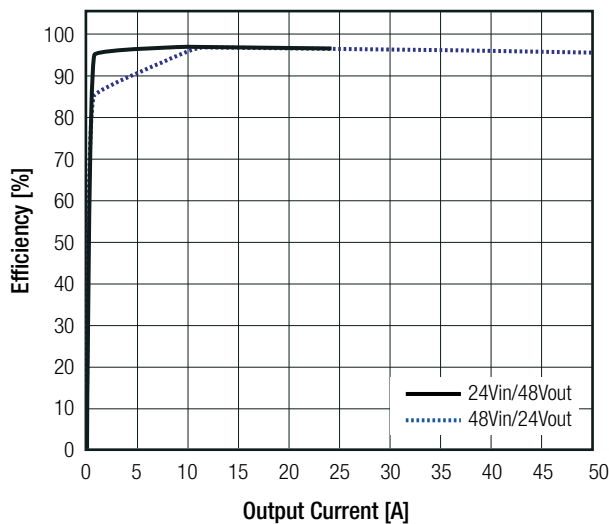

Power Dissipation vs. Output Current

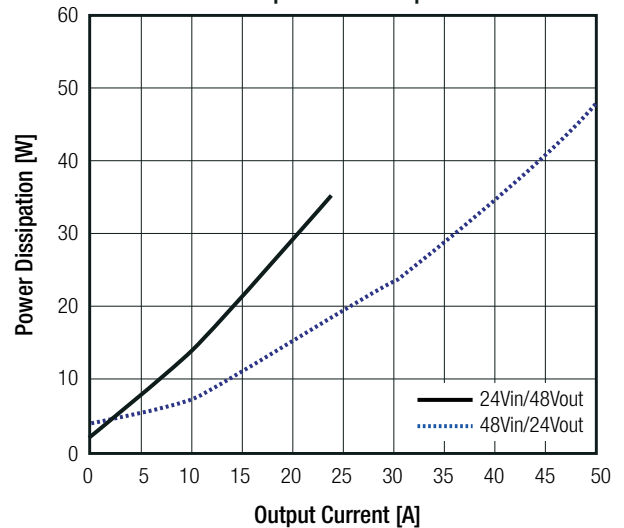

Safe Operating Area

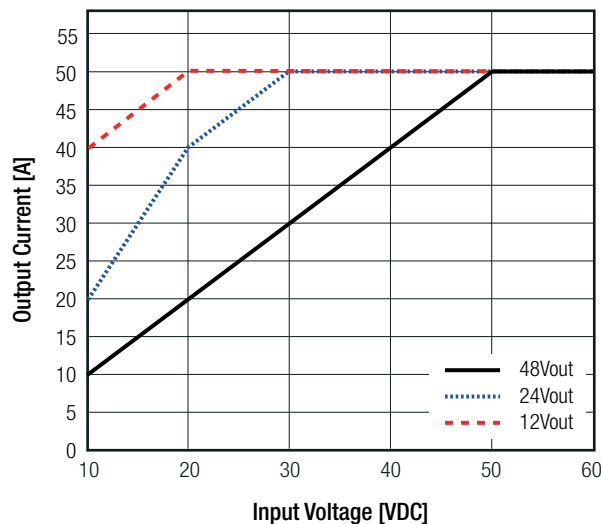

continued on next page

Specifications (measured @ Ta= 25°C, 2.5m/s, nom. Vin, 24Vout and after warm-up unless otherwise stated)

Output Voltage Trimming

The RBBA3000 series offers the feature of trimming the output voltage over a range between 0V and 60V by using precision trim resistors between the Trim and -Sense pin (1% recommended). Undriven Trim pin will set Vout to 0VDC.

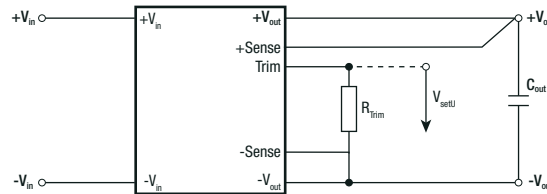

- Vout_{max} = maximum output voltage [VDC]
- Vout_{set} = trimmed output voltage [VDC]
- k = trim up factor []
- V_{setU} = set voltage [VDC]
- V_{ref1}, V_{ref2} = reference voltage [VDC]
- R_{Trim} = trim resistor [Ω]
- R₁, R₂ = internal resistors [Ω]

| Vout _{max} | R ₁ | R ₂ | k | V _{ref1} | V _{ref2} |
|---------------------|----------------|----------------|-------|-------------------|-------------------|
| 60VDC | 11k83Ω | 10k912Ω | 0.058 | 2.366 | 2.316 |

Calculation:

Additionally the Trim pin can be driven from an external voltage source:

$$R_{Trim} = \left[\frac{R_1 \times V_{out_{max}}}{V_{out_{set}} + k \times V_{out_{max}}} \right] - R_2$$

$$V_{setU} = V_{ref1} - V_{ref2} \times \left[\frac{V_{out_{set}}}{V_{out_{max}}} \right]$$

Practical Example RBBA3000-50 (set Vout to 24VDC):

$$R_{Trim} = \left[\frac{11k83 \times 60}{24 + 0.058 \times 60} \right] - 10k912 = \underline{14k918\Omega}$$

$$V_{setU} = 2.366 - 2.316 \times \left[\frac{24}{60} \right] = \underline{1.44V}$$

R_{Trim} according to E96 ≈ 15kΩ

REMOTE SENSE

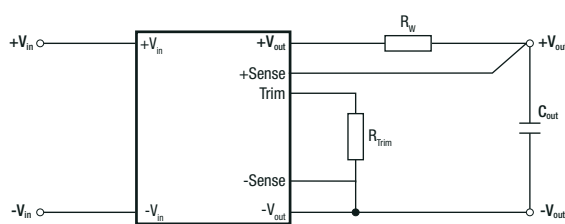

The output voltage can be adjusted via the Trim and -Sense functions. The maximum output voltage from Trim and -Sense function combined is 60VDC. The maximum allowed voltage between +Sense and +Vout pins is 6VDC. Derating may be required when using trim and/or sense functions.

A minimum capacitance value of 100µF is required across the output.

- R_w ... wire losses
- R_{Trim} ... trim resistor

Specifications (measured @ Ta= 25°C, 2.5m/s, nom. Vin, 24Vout and after warm-up unless otherwise stated)

| REGULATIONS | | |
|--------------------|--|--|
| Parameter | Condition | Value |
| Output Accuracy | exclusive R _{Trim} tolerances | ±0.5% typ. |
| Line Regulation | low line to high line, full load | ±1.0% typ. |
| Load Regulation | 0% to 100% load | -4.0% x Vout x (Iout/Iout _{max}) |
| Transient Response | 25% load step recovery time | 600mV max. 200µs typ. |
| Remote Sense | between +Vout and +Sense between -Vout and -Sense | 1.0VDC max. 0.2VDC max. |

| PROTECTIONS | | |
|--------------------------------------|--|---|
| Parameter | Condition | Value |
| Input Over Voltage Protection | 150ms delay | 65VDC |
| Input Over Current Protection | low line to high line | latch off, 55A typ. |
| Output Short Circuit Protection | fixed using I _{set} ⁽⁷⁾ | hiccup mode, 55A typ. hiccup mode, 0-50A |
| Output Over Voltage Protection (OVP) | | latch off, 65VDC typ. |
| Over Temperature Protection (OTP) | case temperature (measured on tc point) | 110°C |

Notes:

Note7: The RBBA3000 series offers the feature of trimming the output current over a range between 0A and 50A by using an external resistor between the I_{set} and the -Vin pin (1% recommended).

Output Current Setting

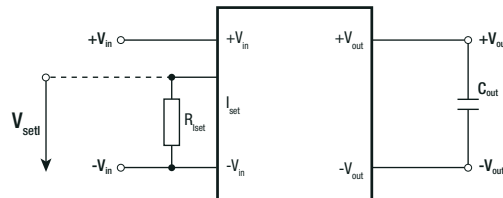

- Iout_{max} = maximum output current [A]
- Iout_{set} = trimmed output current [A]
- k₁, k₂, k₃ = trim up factor []
- V_{set} = set voltage [VDC]
- R_{iset} = trim resistor [kΩ]

| Iout _{max} | k ₁ | k ₂ | k ₃ |
|---------------------|----------------|----------------|----------------|
| 50A | 25 | 3.3 | 2.5 |

Calculation:

$$R_{iset} = \frac{k_1 \times I_{out_set}}{k_2 \times I_{out_max} - k_3 \times I_{out_set}}$$

$$V_{set} = k_3 \times \left[\frac{I_{out_set}}{I_{out_max}} \right]$$

Additionally the I_{set} pin can be driven from an external voltage source:

Practical Example RBBA3000-50:

$$R_{iset} = \frac{25 \times 40}{3.3 \times 50 - 2.5 \times 40} = \underline{\underline{15k38\Omega}}$$

$$V_{set} = 2.5 \times \left[\frac{40}{60} \right] = \underline{\underline{1.67V}}$$

R_{iset} according to E96 ≈ 15k4Ω

Specifications (measured @ Ta= 25°C, 2.5m/s, nom. Vin, 24Vout and after warm-up unless otherwise stated)

ENVIRONMENTAL

| Parameter | Condition | Value |
|--|--|------------------------------|
| Operating Temperature Range ⁽⁸⁾ | @ 2.5m/s convection (refer to "Derating Graph") | -40°C to +85°C |
| Maximum Baseplate Temperature | | +110°C |
| Temperature Coefficient ⁽⁸⁾ | @ 2.5m/s convection and baseplate mounting | 0.05%/K |
| Thermal Impedance | @ 2.5m/s convection and baseplate mounting | 1.2K/W |
| Operating Altitude ⁽⁸⁾ | @ 2.5m/s convection (refer to "Operating Altitude vs. Load") | 5000m |
| Operating Humidity | non-condensing | 5% - 95% RH max. |
| MTBF | according Telcordia SR332 Method I Reliability Prediction at 48Vin, 25°C and 80% load | 1300 x 10 ³ hours |

Notes:

Note8: tested with a test PCB 185x185mm 105µm copper, 6 layer

Derating Graph ⁽⁸⁾

(@ chamber and 2.5m/s convection)

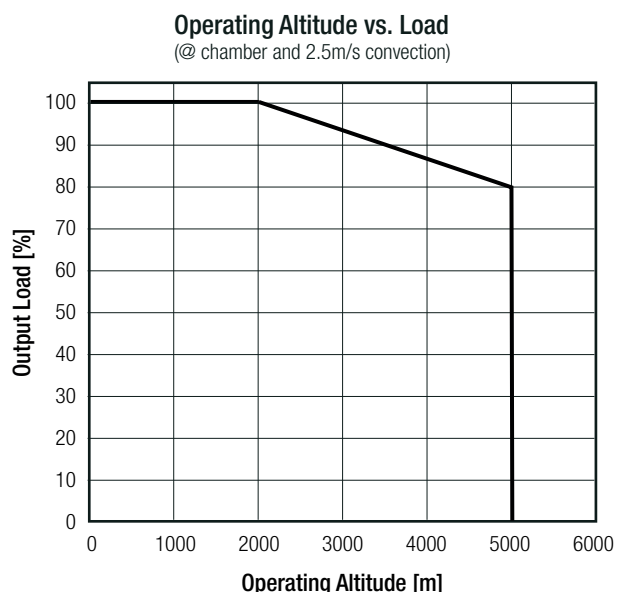
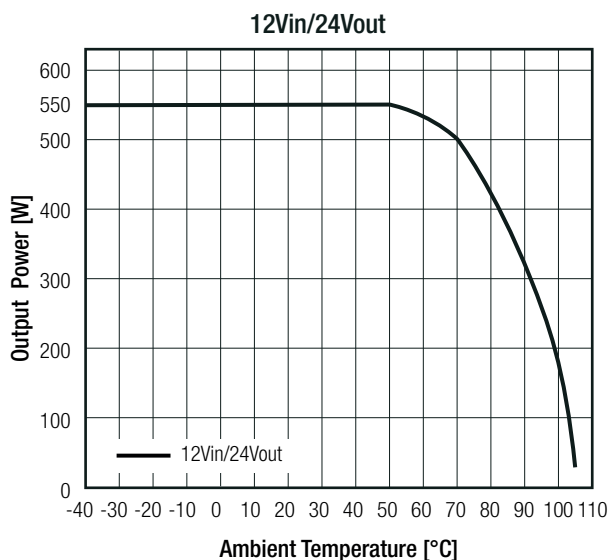
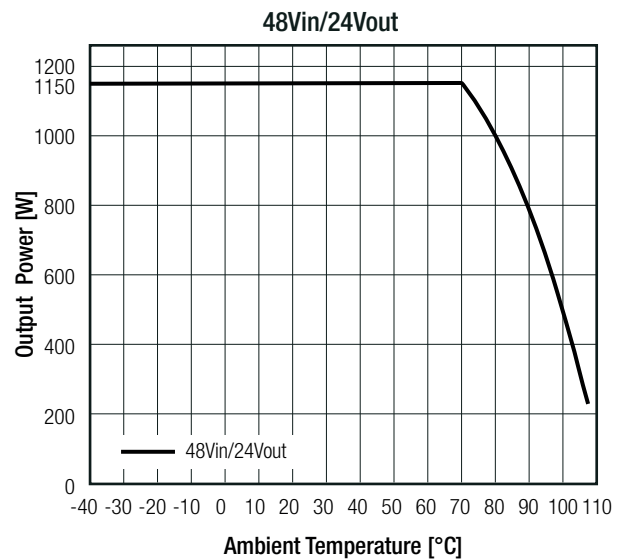
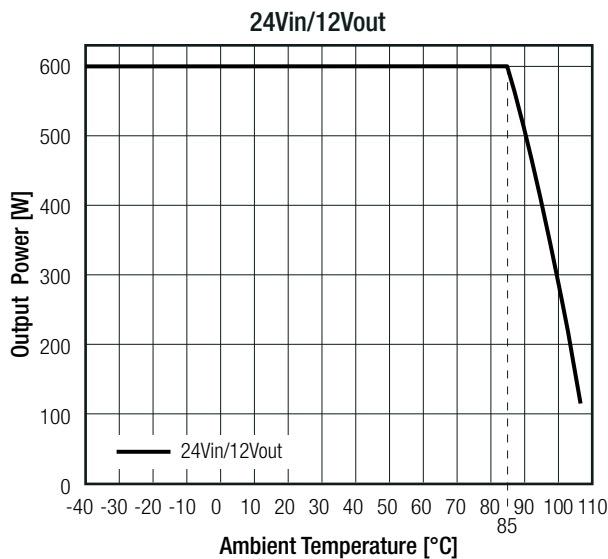

continued on next page

Specifications (measured @ Ta= 25°C, 2.5m/s, nom. Vin, 24Vout and after warm-up unless otherwise stated)

Thermal Calculation:

$$P_{diss} = P_{in} - P_{out} = \frac{P_{out}}{\eta} - P_{out}$$

$$T_{over} = R_{th} \times P_{diss}$$

$$T_{amb} = T_{base\ max.} - T_{over}$$

- T_{base max.} = max. baseplate temperature [°C]
- T_{over} = temperature losses [°C]
- T_{amb} = ambient temperature [°C]
- P_{out} = output power [W]
- η = efficiency (see graph) [%]
- P_{diss} = internal losses [W]
- R_{th} = thermal impedance [K/W]

Practical Example:

Take the **RBBA3000-50** with 48V Input Voltage, 24V Output Voltage, 50A Output Current:
What is the maximum ambient operating temperature?

- T_{base max} = 110°C
- P_{out} = 1k2W
- η = 96%
- R_{th} = 1.2K/W⁽⁸⁾

$$P_{diss} = \frac{1k2W}{0.96} - 1k2W = 50W$$

$$T_{over} = 1.2 \times 50 = 60K$$

$$T_{amb} = 110 - 60 = +50°C$$

SAFETY AND CERTIFICATIONS

| Certificate Type (Safety) | Report / File Number | Standard |
|--|----------------------|------------------------------|
| Audio/video, information and communication technology equipment. Safety requirements (CB Scheme) | E224736-A6003-CB-1 | IEC62368-1:2014 2nd Edition |
| Audio/video, information and communication technology equipment. Safety requirements | | EN62368-1:2014 + A11:2017 |
| RoHS2+ | | RoHS 2011/65/EU + AM2015/863 |

| EMC Compliance | Condition | Standard / Criterion |
|---|--|------------------------|
| Electromagnetic compatibility of multimedia equipment - Emission requirements | with external filter (see suggestion below) | EN55032, Class A and B |
| Information technology equipment - Immunity characteristics - Limits and methods of measurement | | EN55024 |

EMC Filtering Suggestions according to EN55032

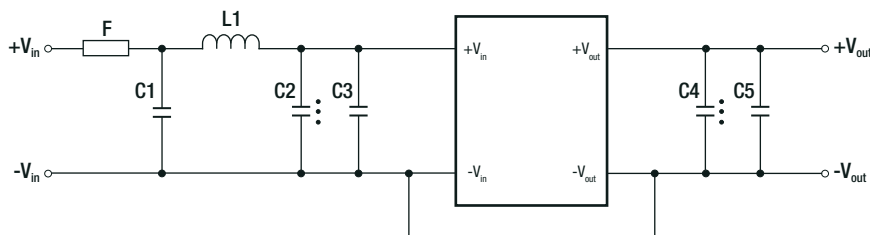

Component List Class A and B

| C1 | L1 | C2 | C3 | C4 | C5 |
|-------------------------|-------------------|-------------------------|--------------------------|-------------------------|-------------------------|
| 2.2µF/100V MLCC 4pcs | 3.3µH/100A 1pc | 470µF/100V E-Cap 1pc | 2.2µF/100V MLCC 18pcs | 470µF/100V E-Cap 1pc | 2.2µF/100V MLCC 4pcs |

DIMENSION AND PHYSICAL CHARACTERISTICS

| Parameter | Type | Value |
|-------------------|------------------------------|--|
| Material | baseplate case potting | aluminium plastic (UL94 V-2) low smoke silicone (UL94 V-0) |
| Dimension (LxWxH) | | 60.60 x 63.2 x 13.0mm |
| Weight | | 155g typ. |

continued on next page

Specifications (measured @ Ta= 25°C, 2.5m/s, nom. Vin, 24Vout and after warm-up unless otherwise stated)

Dimension Drawing (mm)

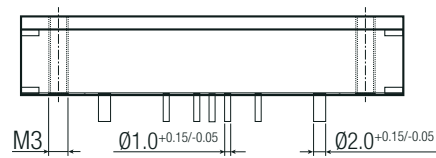
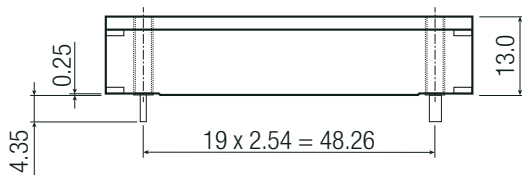
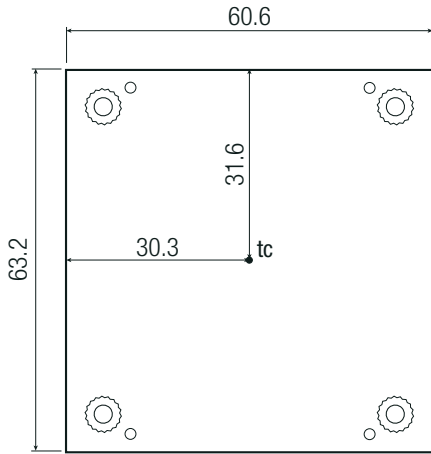
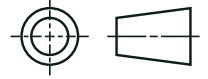

Pin Information

| Pin # | Single |
|-------|----------------------------|
| 1 | +Vin |
| 2 | CTRL |
| 3 | SyncIn connect to -Vin |
| 4 | Iset |
| 5 | Ishare |
| 6 | -Vin |
| 7 | -Vout |
| 8 | -Sense connect to -Vout |
| 9 | Trim |
| 10 | +Sense |
| 11 | +Vout |

xx.x ± 0.5mm
 xx.xx ± 0.25mm
 FC= fixing center
 max. tightening torque
 of mounting holes=0.60Nm

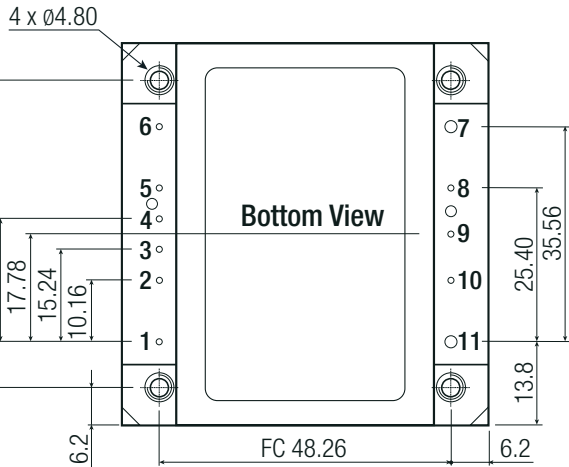

Recommended Footprint Details

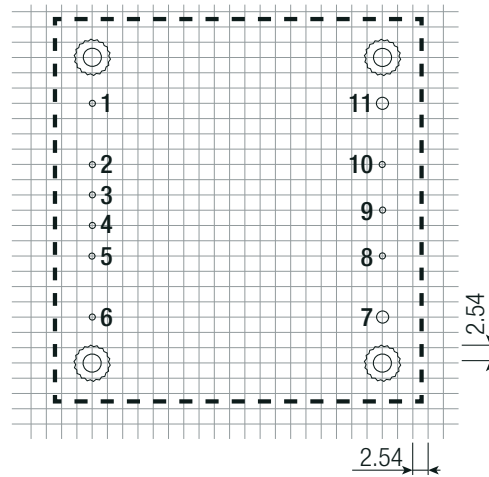

INSTALLATION AND APPLICATION

48Vin to 24Vout converter

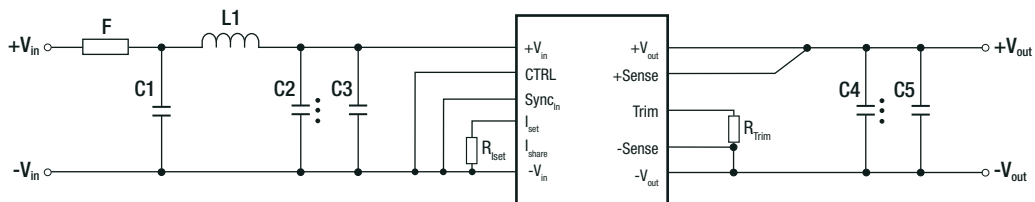

| Input | C1 | L1 | C2 | C3 | R _{iset} | R _{trim} | C4 | C5 | Output |
|-------|-------------------------|-------------------|-------------------------|--------------------------|-------------------|-------------------|-------------------------|-------------------------|---------------|
| 48Vin | 2.2µF/100V MLCC 4pcs | 3.3µH/100V 1pc | 470µF/100V E-Cap 1pc | 2.2µF/100V MLCC 18pcs | 15k4Ω | 23k7Ω | 470µF/100V E-Cap 1pc | 2.2µF/100V MLCC 4pcs | 24Vout 40A |

Specifications (measured @ Ta= 25°C, 2.5m/s, nom. Vin, 24Vout and after warm-up unless otherwise stated)

| PACKAGING INFORMATION | | |
|-----------------------------|----------------|------------------------|
| Parameter | Type | Value |
| Packaging Dimension (LxWxH) | tray | 380.0 x 230.0 x 20.0mm |
| Packaging Quantity | | 12pcs |
| Storage Temperature Range | | -55°C to +125°C |
| Storage Humidity | non-condensing | 95% RH max. |

The product information and specifications may be subject to changes even without prior written notice. The product has been designed for various applications; its suitability lies in the responsibility of each customer. The products are not authorized for use in safety-critical applications without RECOM's explicit written consent. A safety-critical application is an application where a failure may reasonably be expected to endanger or cause loss of life, inflict bodily harm or damage property. The applicant shall indemnify and hold harmless RECOM, its affiliated companies and its representatives against any damage claims in connection with the unauthorized use of RECOM products in such safety-critical applications.

X-ON Electronics

Largest Supplier of Electrical and Electronic Components

Click to view similar products for [Non-Isolated DC/DC Converters](#) category:

Click to view products by [Recom Power](#) manufacturer:

Other Similar products are found below :

[PSR152.5-7IR](#) [APTH003A0X-SRZ](#) [SPM1004-3V3C](#) [R-785.0-05](#) [10E24-P15-10PPM](#) [1E24-P4-25PPM-SHV-5KV](#) [PROPOWER-3.3V](#)
[MYGTM01210BZN](#) [40C24-N250-I5-H](#) [40A24-P30-E](#) [3V12-P0.8](#) [10C24-N250-I10-AQ-DA](#) [4AA24-P20-M-H](#) [3V12-N0.8](#) [3V24-P1](#) [3V24-](#)
[N1](#) [BMR4672010/001](#) [BMR4652010/001](#) [6AA24-P30-I5-M](#) [6AA24-N30-I5-M](#) [BM2P101X-Z](#) [35A24-P30](#) [2.5M24-P1](#) [PTV03010WAD](#)
[PTV05020WAH](#) [PTV12010LAH](#) [PTV12020WAD](#) [R-7212D](#) [R-7212P](#) [R-78AA15-0.5SMD](#) [R-78AA5.0-1.0SMD](#) [30A24-N15-E](#) [10A12-P4-](#)
[M](#) [10C24-N250-I5](#) [10C24-P125](#) [10C24-P250-I5](#) [6A24-P20-I10-F-M-25PPM](#) [1A24-P30-F-M-C](#) [TSR 1-24150SM](#) [1/2AA24-N30-I10](#) [1C24-](#)
[N125](#) [12C24-N250](#) [V7806-1500](#) [PTV12020LAH](#) [PTV05010WAH](#) [PTN04050CAZT](#) [PTH12020WAD](#) [PTH12020LAS](#) [PTH05050YAH](#)
[PTH05T210WAH](#)