

Features

Regulated Converters

- 2kV, 4kVDC & 6kVDC Isolation
- Industry Standard 3W DIP24 Package
- Feedback Regulated Output
- Continuous Short Circuit Protection
- Wide Input 2:1 & 4:1
- Medical Approvals (4kV/6kV Versions)
- EN and UL Certificates
- 3 Pinout Options, 3 Case Styles
- Control Pin Option
- Efficiency to 86%

Description

Besides the standard isolation of 2kVDC, this series offers options of 4kVDC (= "/H4") or 6kVDC (= "/H6") making it suitable for medical applications and other sophisticated industrial applications. Packaging can be either DIP-24 plastic or 5-side-shielded DIP24 metal case (=option "/M") as well as SMD pinning (= option "/SMD"). For all the above variants, 2 industry-standard pinouts (= option "/A" or "/C") are available, and B pinning is available with 1.6kVDC isolation. Remote on/off control is possible with the /CTRL option (A pinning only). The converters can deliver 140% rated power for short periods of time to cope with applications with large capacitive loads or high start up currents.

Selection Guide

Part Number DIP24 (SMD)	Input Voltage (VDC)	Output Voltage (VDC)	Output Current (mA)	Efficiency (%)	Max Capacitive Load ⁽¹⁾
REC3-xx3.3SRW/H*	4.5 - 9, 9 - 18, 18 - 36, 36 - 72	3.3	900	66-76	4700µF
REC3-xx05SRW/H*	4.5 - 9, 9 - 18, 18 - 36, 36 - 72	5	600	71-79	4700µF
REC3-xx09SRW/H*	4.5 - 9, 9 - 18, 18 - 36, 36 - 72	9	330	74-83	3300µF
REC3-xx12SRW/H*	4.5 - 9, 9 - 18, 18 - 36, 36 - 72	12	250	75-85	2200µF
REC3-xx15SRW/H*	4.5 - 9, 9 - 18, 18 - 36, 36 - 72	15	200	75-86	2200µF
REC3-xx05DRW/H*	4.5 - 9, 9 - 18, 18 - 36, 36 - 72	±5	±300	74-83	±2200µF
REC3-xx12DRW/H*	4.5 - 9, 9 - 18, 18 - 36, 36 - 72	±12	±125	75-85	±1000µF
REC3-xx15DRW/H*	4.5 - 9, 9 - 18, 18 - 36, 36 - 72	±15	±100	75-86	±1000µF
REC3-xx3.3SRWZ/H*	9 - 36, 18 - 72	3.3	900	77-79	4700µF
REC3-xx05SRWZ/H*	9 - 36, 18 - 72	5	600	78-80	4700µF
REC3-xx09SRWZ/H*	9 - 36, 18 - 72	9	330	80-83	3300µF
REC3-xx12SRWZ/H*	9 - 36, 18 - 72	12	250	83-85	2200µF
REC3-xx15SRWZ/H*	9 - 36, 18 - 72	15	200	83-85	2200µF
REC3-xx05DRWZ/H*	9 - 36, 18 - 72	±5	±300	77-80	±2200µF
REC3-xx12DRWZ/H*	9 - 36, 18 - 72	±12	±125	83-85	±1000µF
REC3-xx15DRWZ/H*	9 - 36, 18 - 72	±15	±100	83-85	±1000µF

H* = H2, H4 or H6 for A or C pinning options with 2kVDC, 4kVDC or 6kVDC isolation.

H* = H for B pinning option with 1.6kVDC isolation only.

2:1 Input
(REC3-S/DRWH4/H6)
xx = 4.5-9Vin = 05
xx = 9-18Vin = 12
xx = 18-36Vin = 24
xx = 36-72Vin = 48

4:1 Input
(REC3-S/DRWZ(H4/H6))
xx = 9-36Vin = 24
xx = 18-72Vin = 48

- * add suffix "/A", "/A/X2", "/B" or "/C" for pinning options, see next page and Isolation Restrictions.
- * add suffix "/M" for metal case.
- * add suffix "/SMD" for SMD package.
- * add suffix "/CTRL" for control pin option (A Pinning only)
- * add suffix -R for Tape and Reel packaging

Ordering Examples:

REC3-0512DRW/H2/A/CTRL = 2:1 input, 5V Vin, ±12V Vout, 2kVDC, pinout "A", plastic case, control pin
 REC3-4812SRWZ/H4/A/M = 4:1 input, 48V Vin, 12V Vout, 4kVDC, pinout "A", metal case, no control pin
 REC3-2412DRWZ/H/B = 4:1 input, 24V Vin, ±12V Vout, 1.6kVDC, pinout "B", plastic case, no control pin
 REC3-0505SRW/H6/C/SMD-R = 2:1 input, 5V Vin, 5V Vout, 6kVDC, SMD pinout "C", plastic case, no control pin, Tape and Reel packaging.

ECONOLINE

DC/DC-Converter

with 3 year Warranty

RECOM

3 Watt

DIP24 & SMD

Single & Dual

Output



EN-60950-1 Certified
UL-60950-1 Certified
EN-60601-1 Certified

REC3-S_DRW

Isolation Restrictions

'B' Pinning is restricted to 1.6kV isolation due to the closeness of the input and output pins.

If the options "/M" for metal case and "/SMD" for SMD pinout are combined, the maximum allowed isolation voltage is 2kVDC because of the shorter distances between pins and the metal case.

DIP-24 through-hole case and SMD-plastic case are not affected and offer the full isolation barriers of 2kV through to 6kVDC.

Refer to Application Notes

Specifications (measured at $T_A = 25^\circ\text{C}$, nominal input voltage, full load and after warm-up)

Input Voltage Range	2:1 & 4:1		
Output Voltage Accuracy	$\pm 2\%$ max.		
Line Regulation (HL-LL)	$\pm 0.4\%$ max.		
Load Regulation (for output load current change from 20% to 100%)	$\pm 0.6\%$ max.		
Minimum Load	10% ⁽²⁾		
Output Ripple and Noise (0,1 μF capacitor on output, 20MHz BW)	50mVp-p max.		
Switching Frequency at Full Load and nominal Input Voltage	2:1 Input types	90kHz min. / 150kHz max.	
	4:1 Input types	120kHz min. / 180kHz max.	
Input Filter	Pi Network		
Efficiency at Full Load	see above		
No Load Power Consumption	300mW max.		
Isolation Voltage	H2-Suffix (tested for 1 second) (rated for 1 minute**)	2000VDC / 1000VAC / 60Hz	
Isolation Voltage	H4-Suffix (tested for 1 second) (rated for 1 minute**)	4000VDC / 2000VAC / 60Hz	
Isolation Voltage	H6-Suffix (tested for 1 second) (rated for 1 minute**)	6000VDC / 3000VAC / 60Hz	
Isolation Capacitance	2:1 Input types	20pF min. / 60pF max.	
	4:1 Input types	40pF min. / 80pF max.	
Isolation Resistance	1 G Ω min.		
Short Circuit Protection (Max temp. = 60°C during short circuit conditions)	Continuous, Auto Restart		
Operating Temperature Range (free air convection)	5V input types	-40°C to +80°C (see Graph)	
	others	-40°C to +85°C (see Graph)	
Storage Temperature Range	-55°C to +125°C		
Relative Humidity	95% RH		
Case Material	Non-Conductive Plastic or Metal		
Thermal Impedance	Natural convection	20°C/W for plastic case / 12°C/W for metal case	
Package Weight	13g		
Packing Quantity	15 pcs per Tube / 100 pcs per Reel		
MTBF (+25°C)	} Detailed Information see Application Notes chapter "MTBF"	using MIL-HDBK 217F	1043 x 10 ³ hours
(+85°C)		using MIL-HDBK 217F	186 x 10 ³ hours
Certifications	UL General Safety Report: E358085	UL 60950-1 1st Ed. C22.2 No. 60950-1-03	
	EN General Safety Report: SPCLVD1212007	EN60950-1:2006 + A1:2010+A12:2011	
	EN Medical Safety Report: MDD1205098-3 + RM1205098-3	IEC/EN 60601-1 3rd Ed. Medical Report + ISO14971 Risk Assessment	

Derating-Graph (Ambient Temperature)

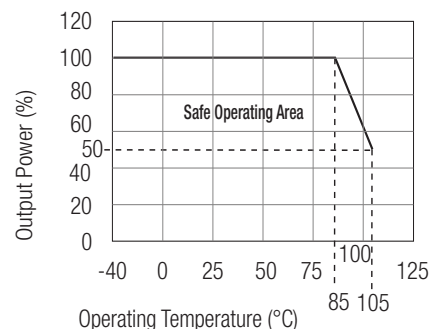
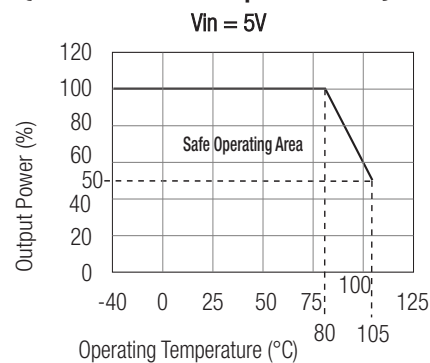

**Any data referred to in this datasheet are of indicative nature and based on our practical experience only. For further details, please refer to our Application Notes.

Notes

- Note 1: Maximum capacitive load is defined as the capacitive load that will allow start up in under 1 second without damage to the converter
- Note 2: The REC3-RW series requires a minimum of 10% load on the output to maintain specified regulation. Operating under no-load conditions will not damage these devices; however, they may not meet all listed specifications.

Typical Characteristics

Single 2:1 Input

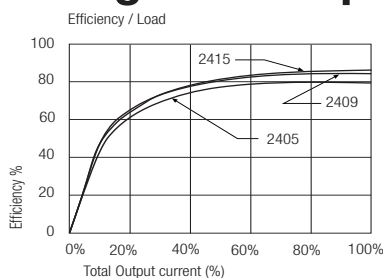

Single 2:1 Input

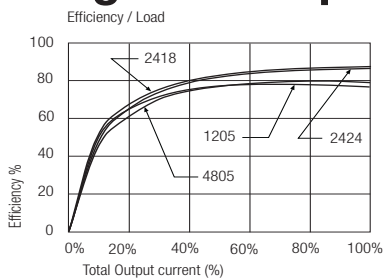

Dual 2:1 Input

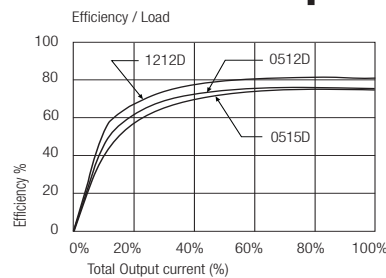

Typical Characteristics - Continued

Single 4:1 Input

Single 4:1 Input

Dual 4:1 Input

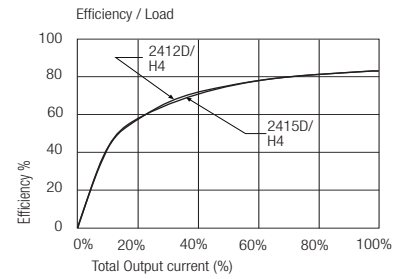
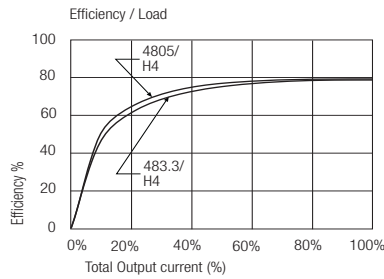
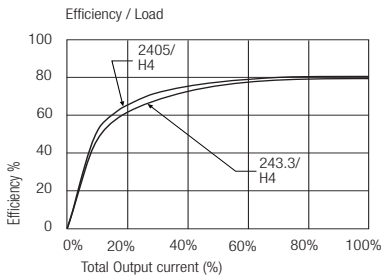

Package Style and Pinning (mm) DIP 24 , Wide Input 2:1 & 4:1

"A" Pinning
/H2, /H4 & /H6

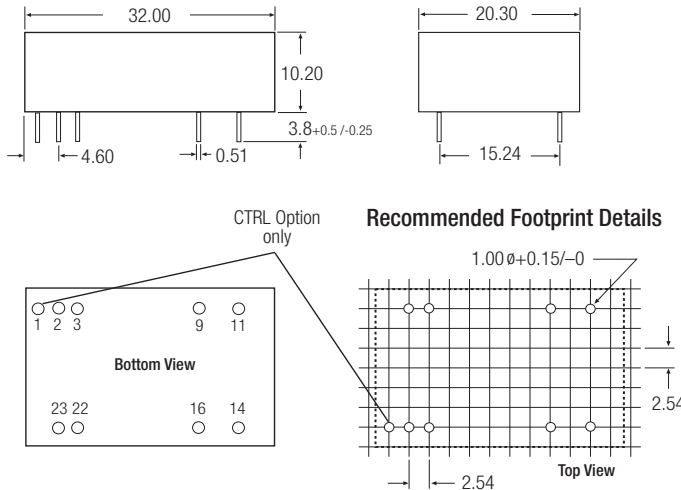

Pin Connections

Pin #	Single	Single/X2	Dual
1 (option)	CTRL	CTRL	CTRL
2	-Vin	-Vin	-Vin
3	-Vin	-Vin	-Vin
9	NC	No Pin	Com
11	NC	NC	-Vout
14	+Vout	+Vout	+Vout
16	-Vout	-Vout	Com
22	+Vin	+Vin	+Vin
23	+Vin	+Vin	+Vin

NC = No Connection
XX.X ± 0.5 mm
XX.XX ± 0.25 mm

CTRL Option

ON = Open or $0V < V_{ctrl} < 1.2V$
OFF = $2.2V < V_{ctrl} < 12V$

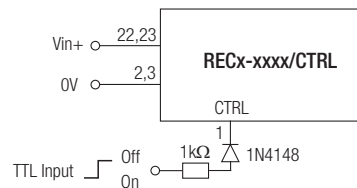

"C" Pinning
/H2, /H4 & /H6

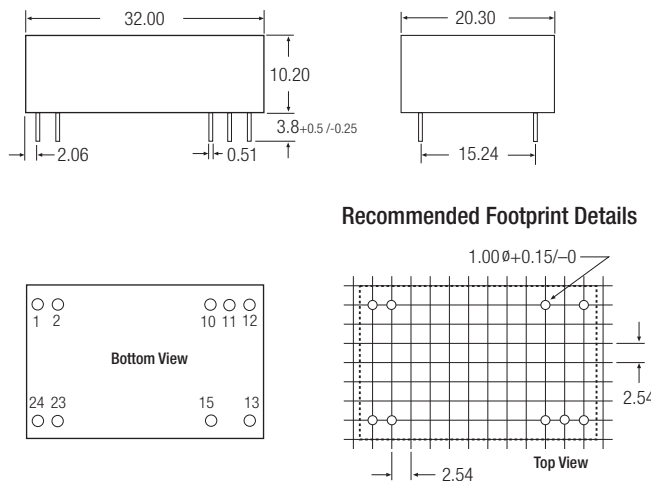

Pin Connections

Pin #	Single	Dual
1	+Vin	+Vin
2	+Vin	+Vin
10	NC	Com
11	NC	Com
12	-Vout	NC
13	+Vout	-Vout
15	NC	+Vout
23	-Vin	-Vin
24	-Vin	-Vin

NC = No Connection
XX.X ± 0.5 mm
XX.XX ± 0.25 mm

"B" Pinning
/H (1.6kV Only)

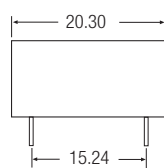
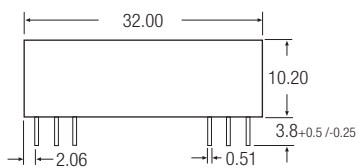

Recommended Footprint Details

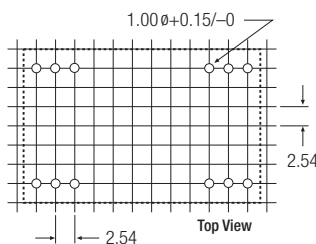
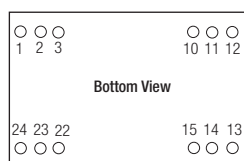

Pin Connections

Pin #	Single	Dual
1	+Vin	+Vin
2	No Pin	-Vout
3	No Pin	Com
10	-Vout	Com
11	+Vout	+Vout
12	-Vin	-Vin
13	-Vin	-Vin
14	+Vout	+Vout
15	-Vout	Com
22	No Pin	Com
23	No Pin	-Vout
24	+Vin	+Vin

NC = No Connection

XX.X ± 0.5 mm

XX.XX ± 0.25 mm

SMD Pinning

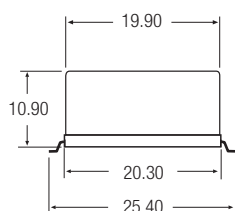
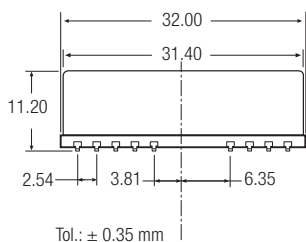

Recommended Footprint Details

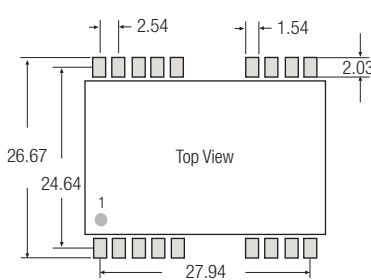
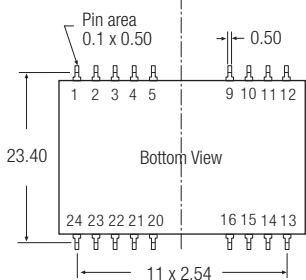

SMD pin connections follow standard package A (/A/SMD), B (/B/SMD) or C (/C/SMD) pinning.

All unused pins are NC (No Connection). See Below for detailed pinout lists

for all packages incl.SMD case the length of plastic case is 31,8 mm, length of metal case 32.0 mm

/A/SMD Pinning

/B/SMD Pinning

/C/SMD Pinning

Pin Connections			Pin Connections			Pin Connections			Pin Connections			Pin Connections		
Pin #	Single	Dual	Pin #	Single	Dual	Pin #	Single	Dual	Pin #	Single	Dual	Pin #	Single	Dual
1 (Option)	CTRL	CTRL	13	NC	NC	1	+Vin	+Vin	13	-Vin	-Vin	1	+Vin	+Vin
2	-Vin	-Vin	14	+Vout	+Vout	2	NC	-Vout	14	+Vout	+Vout	2	+Vin	+Vin
3	-Vin	-Vin	15	NC	NC	3	NC	Com	15	-Vout	Com	3	NC	NC
4	NC	NC	16	-Vout	Com	4	NC	NC	16	NC	NC	4	NC	NC
5	NC	NC	20	NC	NC	5	NC	NC	20	NC	NC	5	NC	NC
9	NC	Com	21	NC	NC	9	NC	NC	21	NC	NC	9	NC	NC
10	NC	NC	22	+Vin	+Vin	10	-Vout	Com	22	NC	Com	10	NC	Com
11	NC	-Vout	23	+Vin	+Vin	11	+Vout	+Vout	23	NC	-Vout	11	NC	Com
12	NC	NC	24	NC	NC	12	-Vin	-Vin	24	+Vin	+Vin	12	-Vout	NC

X-ON Electronics

Largest Supplier of Electrical and Electronic Components

Click to view similar products for [Isolated DC/DC Converters](#) category:

Click to view products by [Recom Power](#) manufacturer:

Other Similar products are found below :

[ESM6D044440C05AAQ](#) [FMD15.24G](#) [PSL486-7LR](#) [Q48T30020-NBB0](#) [JAHW100Y1](#) [SPB05C-12](#) [SQ24S15033-PS0S](#) [18952](#) [19-130041](#)
[CE-1003](#) [CE-1004](#) [GQ2541-7R](#) [RDS180245](#) [MAU228](#) [J80-0041NL](#) [DFC15U48D15](#) [XGS-0512](#) [XGS-1205](#) [XGS-1212](#) [XGS-2412](#) [XGS-](#)
[2415](#) [XKS-1215](#) [06322](#) [NCT1000N040R050B](#) [SPB05B-15](#) [SPB05C-15](#) [L-DA20](#) [DCG40-5G](#) [QME48T40033-PGB0](#) [XKS-2415](#) [XKS-2412](#)
[XKS-1212](#) [XKS-1205](#) [XKS-0515](#) [XKS-0505](#) [XGS-2405](#) [XGS-1215](#) [XGS-0515](#) [PS9Z-6RM4](#) [73-551-5038I](#) [AK1601-9RT](#) [VI-N61-CM](#) [VI-](#)
[R5022-EXWW](#) [PSC128-7iR](#) [RPS8-350ATX-XE](#) [DAS1004812](#) [PQA30-D24-S24-DH](#) [VI-M5F-CQ](#) [VI-LN2-EW](#) [VI-PJW01-CZY](#)