

Features

Regulated Converters

- High 4kVDC & 6kVDC Isolation
- 5W DIP24 Industry Standard Package
- Feedback Regulated Output
- Continuous Short Circuit Protection
- Wide Inputs 2:1 & 4:1
- Approved for Medical Applications
- UL and EN Safety Approvals
- 2 Pinout Options, 3 Case Styles
- Efficiency to 86 %

Description

This series offers standard isolation of 2kVDC with 4kVDC or 6kVDC options making it ideal for both industrial, medical and other sophisticated high end applications. Packaging can be either DIP-24 non-conductive plastic or 5-side-shielded DIP24 metal case (= option "/M") as well as DIP24-SMD case (= option "/SMD"). For all the above variants, 2 industry-standard pinouts (= option "/A" or "/C") are available. "B" pinning is also available with "/H" isolation of 1.6kVDC. Remote on/off control is possible with the /CTRL option ("A" pinning only). The converters can deliver 140% rated power for short periods of time to cope with applications with large capacitive loads or high start up currents.

Selection Guide

Part Number DIP24 (SMD)	Input Voltage (VDC)	Output Voltage (VDC)	Output Current (mA)	Efficiency (%)	Max Capacitive Load ⁽¹⁾
REC5-xx3.3SRW/H*	9 - 18, 18 - 36, 36 - 72	3.3	1000	75-77	6800µF
REC5-xx05SRW/H*	9 - 18, 18 - 36, 36 - 72	5	1000	79-81	6800µF
	4.5 - 9V			72	
REC5-xx09SRW/H*	9 - 18, 18 - 36, 36 - 72	9	556	82-83	6800µF
	4.5 - 9V			73	
REC5-xx12SRW/H*	9 - 18, 18 - 36, 36 - 72	12	420	84-85	6800µF
	4.5 - 9V			74	
REC5-xx15SRW/H*	9 - 18, 18 - 36, 36 - 72	15	340	85-86	6800µF
	4.5 - 9V			75	
REC5-xx05DRW/H*	9 - 18, 18 - 36, 36 - 72	±5	±500	79-81	±2200µF
	4.5 - 9V			72	
REC5-xx09DRW/H*	9 - 18, 18 - 36, 36 - 72	±9	±278	82-84	±2200µF
	4.5 - 9V			74	
REC5-xx12DRW/H*	9 - 18, 18 - 36, 36 - 72	±12	±210	84-85	±2200µF
	4.5 - 9V			75	
REC5-xx15DRW/H*	9 - 18, 18 - 36, 36 - 72	±15	±170	85-86	±2200µF
	4.5 - 9V			75	
REC5-xx3.3SRWZ/H*	9 - 36**, 18 - 72	3.3	1000	75-76	6800µF
REC5-xx05SRWZ /H*	9 - 36**, 18 - 72	5	1000	81-82	6800µF
REC5-xx09SRWZ/H*	9 - 36, 18 - 72	9	556	82-83	6800µF
REC5-xx12SRWZ /H*	9 - 36, 18 - 72	12	420	83-84	6800µF
REC5-xx15SRWZ/H*	9 - 36, 18 - 72	15	340	84-85	6800µF
REC5-xx05DRWZ/H*	9 - 36**, 18 - 72	±5	±500	81-82	±2200µF
REC5-xx09DRWZ/H*	9 - 36, 18 - 72	±9	±278	82-84	±2200µF
REC5-xx12DRWZ /H*	9 - 36, 18 - 72	±12	±210	82-83	±2200µF
REC5-xx15DRWZ /H*	9 - 36, 18 - 72	±15	±170	84-85	±2200µF

H* = H2, H4 or H6 for A or C pinning options with 2kVDC, 4kVDC or 6kVDC isolation.

H* = H for B pinning option with 1.6kVDC isolation only. ** Derate to 900mA (±450mA) max. at Vin=9V

* add suffix "/A", "/A/2", "/B" or "/C" for pinning options, see next page and Isolation Restrictions.

* add suffix "/M" for metal case.

* add suffix "/SMD" for SMD package.

* add suffix "/CTRL" for control pin option (A Pinning only)

* add suffix -R for Tape and Reel packaging

2:1 Input

(REC5-S/DRW)

xx = 4.5-9Vin = 05

xx = 9-18Vin = 12

xx = 18-36Vin = 24

xx = 36-72Vin = 48

4:1 Input

(REC5-S/DRWZ)

xx = 9-36Vin = 24

xx = 18-72Vin = 48

ECONOLINE

DC/DC-Converter

with 3 year Warranty

RECOM

5 Watt DIP24 & SMD Single & Dual Output



EN-60950-1 Certified
UL-60950-1 Certified
EN-60601-1 Certified

REC 5

Derating-Graph (Ambient Temperature)



Refer to Application Notes

Specifications (measured at $T_A = 25^\circ\text{C}$, nominal input voltage, full load and after warm-up)

Input Voltage Range			2:1 & 4:1
Output Voltage Accuracy			$\pm 2\%$ max.
Line Regulation (HL-LL)			$\pm 0.3\%$ max.
Load Regulation (for output load current change from 20% to 100%)			$\pm 0.6\%$ max.
Minimum Load			10% ⁽²⁾
Output Ripple and Noise (0,1 μF capacitor on output, 20MHz BW)			50mVp-p max.
Operating Frequency at Full Load	2:1 input		120kHz typ.
(at nominal input voltage)	4:1 input		200kHz typ.
Input Filter			Pi Network
Efficiency at Full Load			see above
No Load Power Consumption			300mW max.
Isolation Voltage	H2-Suffix	(tested for 1 second) (rated for 1 minute**)	2000VDC 1000VAC / 60Hz
Isolation Voltage	H4-Suffix	(tested for 1 second) (rated for 1 minute**)	4000VDC 2000VAC / 60Hz
Isolation Voltage	H6-Suffix	(tested for 1 second) (rated for 1 minute**)	6000VDC 3000VAC / 60Hz
Isolation Capacitance			60pF typ.
Isolation Resistance			1 G Ω min.
Short Circuit Protection (Max temp. = 50°C during short circuit conditions)			Continuous, Auto Restart
Operating Temperature (free air convection)			-40°C to +75°C (see Graph)
Storage Temperature Range			-55°C to +125°C
Relative Humidity			95% RH
Case Material			Non-Conductive Plastic or Metal
Thermal Impedance	Natural convection		20°C/W for plastic case 12°C/W for metal case
Package Weight			13g
Packing Quantity			15 pcs per Tube 100 pcs per Reel
MTBF (+25°C)	Detailed Information see Application Notes chapter "MTBF"	using MIL-HDBK 217F	850 x 10 ³ hours
(+75°C)		using MIL-HDBK 217F	206 x 10 ³ hours
Certifications			
UL General Safety	Report: E358085		UL 60950-1 1st Ed. C22.2 No. 60950-1-03
EN General Safety	Report: SPLCLVD1212007	EN60950-1:2006 + 9+A1:2010+A12:2011	
EN Medical Safety	Report: MDD1205098-3 + RM1205098-3		IEC/EN 60601-1 3rd Edition, Medical Report + ISO14971 Risk Assessment

Isolation Restrictions

"B" Pinning is restricted to 1.6kV isolation due to the closeness of the input and output pins.

If the options "/M" for metal case and "/SMD" for SMD pinout are combined, the maximum allowed isolation voltage is 2kVDC because of the shorter distances between pins and the metal case.

DIP-24 through-hole case and SMD-plastic case are not affected and offer the full isolation barriers of 2kV through to 6kVDC.

Ordering Examples:

REC5-0512DRW/H2/A/CTRL= 2:1 input, 5V Vin, $\pm 12\text{V}$ Vout, 2kVDC, pinout "A", plastic case, control pin

REC5-4812SRWZ/H4/A/M = 4:1 input, 48V Vin, 12V Vout, 4kVDC, pinout "A", metal case, no control pin

REC5-1212DRWZ/H/B = 4:1 input, 12V Vin, $\pm 12\text{V}$ Vout, 1.6kVDC, pinout "B", plastic case, no control pin

REC5-0505SRW/H6/C/SMD = 2:1 input, 5V Vin, 5V Vout, 6kVDC, SMD pinout "C", plastic case, no control pin

**Any data referred to in this datasheet are of indicative nature and based on our practical experience only. For further details, please refer to our Application Notes.

Notes

- Note 1: Maximum capacitive load is defined as the capacitive load that will allow start up in under 1 second without damage to the converter.
- Note 2: The REC 5 series requires a minimum of 10% load on the output to maintain specified regulation. Operating under no-load conditions will not damage these devices; however, they may not meet all listed specifications.

Typical Characteristics

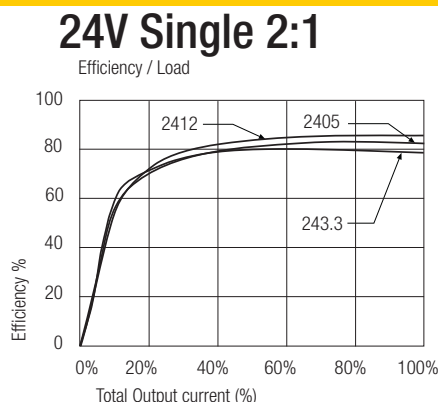
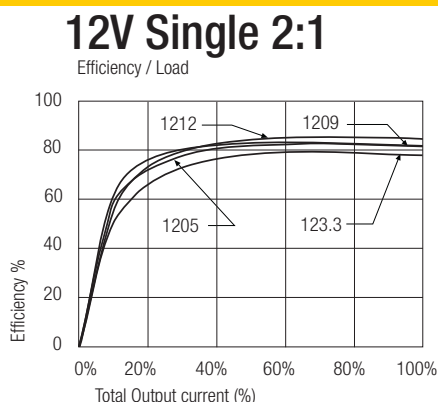

Typical Characteristics

48V Single 2:1

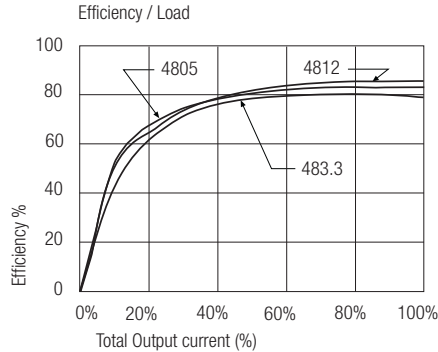

Dual 4:1

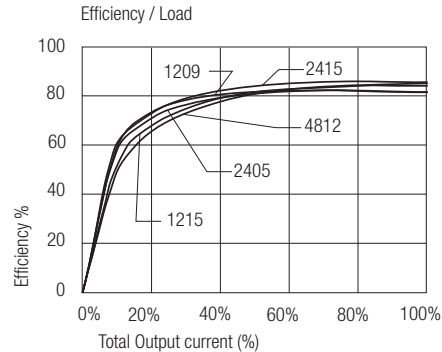

Package Style and Pinning (mm) DIP 24 , Wide Input 2:1 & 4:1

"A" Pinning

/H2, /H4 & /H6

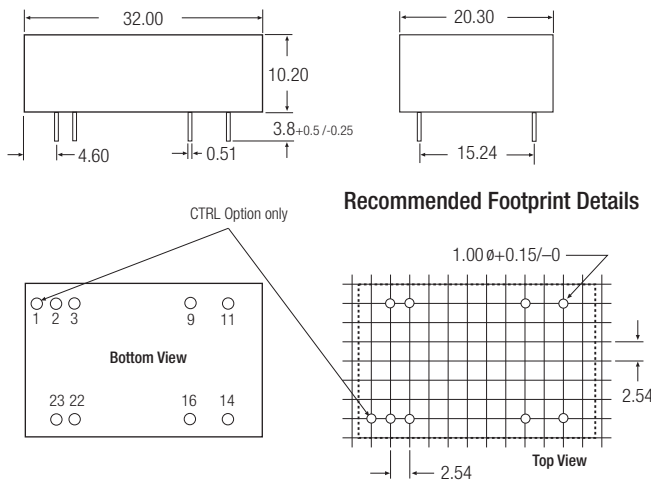

Pin Connections

Pin #	Single	Single/X2	Dual
1 (option)	CTRL	CTRL	CTRL
2	-Vin	-Vin	-Vin
3	-Vin	-Vin	-Vin
9	NC	No Pin	Com
11	NC	NC	-Vout
14	+Vout	+Vout	+Vout
16	-Vout	-Vout	Com
22	+Vin	+Vin	+Vin
23	+Vin	+Vin	+Vin

NC = No Connection
XX.X ± 0.5 mm
XX.XX ± 0.25 mm

CTRL Option

ON = Open or $0V < V_{ctrl} < 1.2V$
OFF = $2.2V < V_{ctrl} < 12V$

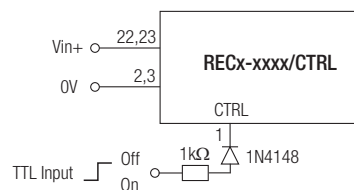

"C" Pinning

/H2, /H4 & /H6

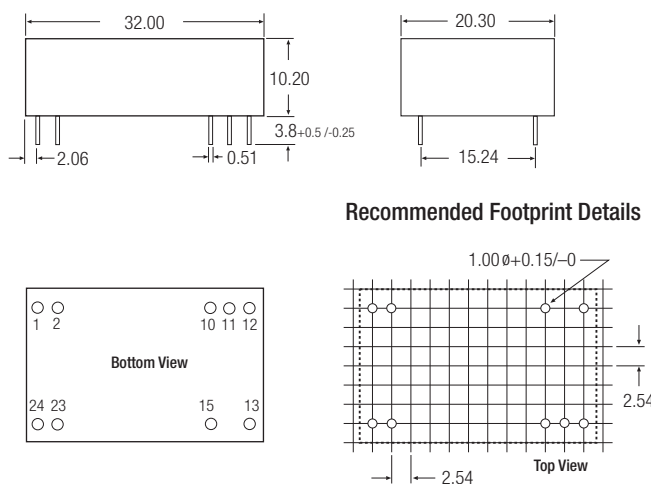

Pin Connections

Pin #	Single	Dual
1	+Vin	+Vin
2	+Vin	+Vin
10	NC	Com
11	NC	Com
12	-Vout	NC
13	+Vout	-Vout
15	NC	+Vout
23	-Vin	-Vin
24	-Vin	-Vin

NC = No Connection

XX.X ± 0.5 mm
XX.XX ± 0.25 mm

Package Style and Pinning (mm) DIP 24 , Wide Input 2:1 & 4:1

"B" Pinning /H (1.6kV Only)



Recommended Footprint Details

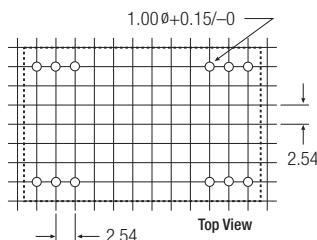

Pin Connections

Pin #	Single	Dual
1	+Vin	+Vin
2	No Pin	-Vout
3	No Pin	Com
10	-Vout	Com
11	+Vout	+Vout
12	-Vin	-Vin
13	-Vin	-Vin
14	+Vout	+Vout
15	-Vout	Com
22	No Pin	Com
23	No Pin	-Vout
24	+Vin	+Vin

NC = No Connection

XX.X ± 0.5 mm

XX.XX ± 0.25 mm

SMD Pinning



Recommended Footprint Details



SMD pin connections follow standard package A (/A/SMD), B (/B/SMD) or C (/C/SMD) pinning.

All unused pins are NC (No Connection). See Below for detailed pinout lists

for all packages incl.SMD case the length of plastic case is 31,8 mm, length of metal case 32.0 mm

/A/SMD Pinning

/B/SMD Pinning

/C/SMD Pinning

Pin Connections			Pin Connections			Pin Connections			Pin Connections			Pin Connections			Pin Connections		
Pin #	Single	Dual	Pin #	Single	Dual	Pin #	Single	Dual	Pin #	Single	Dual	Pin #	Single	Dual	Pin #	Single	Dual
1 (Option)	CTRL	CTRL	13	NC	NC	1	+Vin	+Vin	13	-Vin	-Vin	1	+Vin	+Vin	13	+Vout	-Vout
2	-Vin	-Vin	14	+Vout	+Vout	2	NC	-Vout	14	+Vout	+Vout	2	+Vin	+Vin	14	NC	NC
3	-Vin	-Vin	15	NC	NC	3	NC	Com	15	-Vout	Com	3	NC	NC	15	NC	+Vout
4	NC	NC	16	-Vout	Com	4	NC	NC	16	NC	NC	4	NC	NC	16	NC	NC
5	NC	NC	20	NC	NC	5	NC	NC	20	NC	NC	5	NC	NC	20	NC	NC
9	NC	Com	21	NC	NC	9	NC	NC	21	NC	NC	9	NC	NC	21	NC	NC
10	NC	NC	22	+Vin	+Vin	10	-Vout	Com	22	NC	Com	10	NC	Com	22	NC	NC
11	NC	-Vout	23	+Vin	+Vin	11	+Vout	+Vout	23	NC	-Vout	11	NC	Com	23	-Vin	-Vin
12	NC	NC	24	NC	NC	12	-Vin	-Vin	24	+Vin	+Vin	12	-Vout	NC	24	-Vin	-Vin

X-ON Electronics

Largest Supplier of Electrical and Electronic Components

Click to view similar products for [Isolated DC/DC Converters](#) category:

Click to view products by [RECOM POWER](#) manufacturer:

Other Similar products are found below :

[ESM6D044440C05AAQ](#) [FMD15.24G](#) [PSL486-7LR](#) [PSR152.5-7IR](#) [Q48T30020-NBB0](#) [AVO240-48S12B-6L](#) [AVO250-48S28B-6L](#) [NAN-0505](#) [HW-L16D](#) [JAHW100Y1](#) [217-1617-001](#) [22827](#) [SPB05C-12](#) [SQ24S15033-PS0S](#) [18952](#) [19-130041](#) [CE-1003](#) [CE-1004](#) [GQ2541-7R](#) [PSE1000DCDC-12V](#) [RDS180245](#) [MAU228](#) [419-2065-201](#) [449-2075-101](#) [V300C24C150BG](#) [419-2062-200](#) [419-2063-401](#) [419-2067-101](#) [419-2067-501](#) [419-2068-001](#) [DFC15U48D15](#) [449-2067-000](#) [XGS-0512](#) [XGS-1205](#) [XGS-1212](#) [XGS-2412](#) [XGS-2415](#) [XKS-1215](#) [033456](#) [NCT1000N040R050B](#) [SPB05B-15](#) [SPB05C-15](#) [VI-26B-CU](#) [V24C12C100BG](#) [L-DA20](#) [HP3040-9RG](#) [HP1001-9RTG](#) [DCG40-5G](#) [XKS-2415](#) [XKS-2412](#)