

# Features

# Regulated Converter

- Reinforced insulation for 250VAC working voltage
- Clearance and creepage distance: 8mm
- 5kVAC I/P to O/P 2MOPP isolation
- 2µA patient leakage current
- Industry standard pinout
- 2:1 and 4:1 wide input range



# REM6

**6 Watt**  
**2:1 & 4:1**  
**DIP24**  
**Single and Dual Output**



## Description

The REM6 series of medical grade regulated DC/DC converters features reinforced 5kVAC/1 minute isolation with low 2µA leakage and are 60601-1 3rd Ed. certified for 250VAC continuous working. The compact DIP24 package offers tightly regulated single and dual outputs, even under no-load conditions. The outputs are short circuit and overload protected. The converters are available in two different pinning options and optionally with an external control pin for standby consumption as low as 12.5mW. The converters are fully certified to CB, IEC/EN and ANSI/AAMI standards and carry the UL mark.

## Selection Guide

Part Number	nom. Input Voltage <sup>(1)</sup> [VDC]	Output Voltage [VDC]	Output Current [mA]	Efficiency typ. [%]	Max. Capacitive Load [µF]
REM6-xx3.3S/ <sup>(3,4)</sup>	5 / 12 / 24 / 48	3.3	1800	81.5 / 83.5 / 83 / 82.5	2100
REM6-xx05S/ <sup>(3,4)</sup>	5 / 12 / 24 / 48	5	1200	86 / 86 / 86 / 86.5	1500
REM6-xx12S/ <sup>(3,4)</sup>	5 / 12 / 24 / 48	12	500	86 / 89 / 89 / 88	260
REM6-xx15S/ <sup>(3,4)</sup>	5 / 12 / 24 / 48	15	400	87.5 / 88.5 / 88.5 / 88.5	210
REM6-xx24S/ <sup>(3,4)</sup>	5 / 12 / 24 / 48	24	250	87 / 88.5 / 88.5 / 88	75
REM6-xxx05D/ <sup>(3,4)</sup>	5 / 12 / 24 / 48	±5	±600	84 / 85 / 85 / 85	±860
REM6-xx12D/ <sup>(3,4)</sup>	5 / 12 / 24 / 48	±12	±250	86.5 / 89 / 88.5 / 88	±150
REM6-xx15D/ <sup>(3,4)</sup>	5 / 12 / 24 / 48	±15	±200	87.5 / 88 / 88.5 / 87	±110
REM6-xx3.3SW/ <sup>(3,4)</sup>	24 / 48	3.3	1800	83 / 82.5	2100
REM6-xx05SW/ <sup>(3,4)</sup>	24 / 48	5	1200	86 / 86.5	1500
REM6-xx12SW/ <sup>(3,4)</sup>	24 / 48	12	500	89 / 88	260
REM6-xx15SW/ <sup>(3,4)</sup>	24 / 48	15	400	89 / 88.5	210
REM6-xx24SW/ <sup>(3,4)</sup>	24 / 48	24	250	88.5 / 88	75
REM6-xx05DW/ <sup>(3,4)</sup>	24 / 48	±5	±600	85 / 85	±860
REM6-xx12DW/ <sup>(3,4)</sup>	24 / 48	±12	±250	88.5 / 88	±150
REM6-xx15DW/ <sup>(3,4)</sup>	24 / 48	±15	±200	88.5 / 87	±110



## Model Numbering

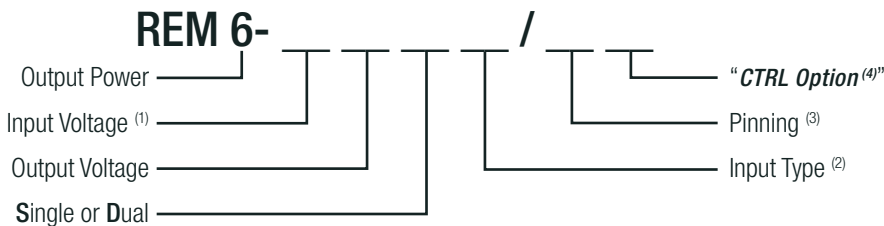

### Notes:

Note1: for 4:1 Input Voltage Type add "W", see Note 2.

2:1	nom. Vin	4:1 "W"	nom. Vin
xx= 4.5-9 Vin	= "05"	xx= 9-36Vin	= "24"
xx= 9-18Vin	= "12"	xx= 18-75Vin	= "48"
xx= 18-36Vin	= "24"		
xx= 36-75Vin	= "48"		

Note2: Blank for Standard 2:1 Input Voltage Range; „W“ suffix for 4:1 Input Voltage Range

Note3: „A“ suffix for A pinning; „C“ suffix for C pinning, for more details refer to Package Style and Pinning

Note4: „CTRL“ suffix for control pin option, for A pinning only, for C pinning not available

### Examples:

REM6-0512D/A	=	2:1 Input, 4.5-9Vin, ±12Vout, pinout „A“, without control pin
REM6-1215S/C	=	2:1 Input, 9-18Vin, 15Vout, pinout „C“, without control pin
REM6-4815SW/A/CTRL	=	4:1 Input, 36-75Vin, 15Vout, pinout „A“ with control pin
REM6-243.3SW/C	=	4:1 Input, 9-36Vin, 3.3Vout, pinout „C“, without control pin

IEC/EN60601-1 certified  
 CSA/CAN C22.2 60601-01 certified  
 ANSI/AAMI ES60601-1 certified  
 EN55011 certified

Specifications (measured @ Ta= 25°C, nominal input voltage, full load and after warm-up)

**BASIC CHARACTERISTICS**

Parameter	Condition		Min.	Typ.	Max.
Absolute Maximum Input Voltage ( 3sec max.)	2:1 input	5Vin nom. 12Vin nom. 24Vin nom. 48Vin nom.			16VDC 25VDC 50VDC 100VDC
	4:1 input	24Vin nom. 48Vin nom.			50VDC 100VDC
Under Voltage Lockout	2:1 input	5Vin nom. 12Vin nom. 24Vin nom. 48Vin nom.	4VDC 8VDC 16VDC 33VDC		4.5VDC 9VDC 18VDC 36VDC
	4:1 input	24Vin nom. 48Vin nom.	8VDC 16VDC		9VDC 18VDC
Start-up Time	constant resistive load, Power up or Remote ON/OFF			30ms	
Remote ON/OFF (referenced to -Vin Pin)	DC-DC ON DC-DC OFF				Open or 0-1.2VDC 2.2-12VDC
Current of CTRL Pin			-0.5mA		1mA
Remote OFF Input Current				2.5mA	
Internal Operating Frequency			225kHz	250kHz	275kHz
Output Ripple and Noise (20MHz BW limited)	10µF/25V X7R MLCC for 3.3, 5Vout 10µF/25V X7R MLCC for 12, 15Vout 4.7µF/50V X7R MLCC for 24Vout			30mVp-p 40mVp-p 50mVp-p	

**Efficiency vs. Load**

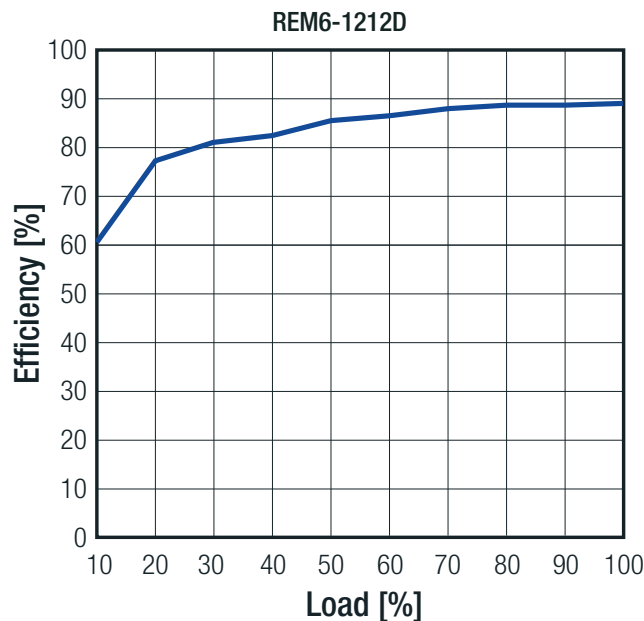

**REGULATIONS**

Parameter	Condition	Type	Value
Output Accuracy			±1.0%
Line Regulation	low line to high line	Single	±0.2%
		Dual	±0.5%
Load Regulation	no load to full load	Single	0.2%
		Dual	1.0%
Cross Regulation	asymmetrical load 25% / Full Load	only Dual Output	±5.0%
Transient Response	25% load step change		250µs

**Specifications** (measured @ Ta= 25°C, nominal input voltage, full load and after warm-up)

PROTECTIONS			
Parameter	Condition	Type	Value
Short Circuit Protection (SCP)			continuous, auto-recovery
Over Load Protection (OLP)	% of Iout rated		Hiccup mode, 150% typ.
Output Over Voltage Protection (OVP)		Single	3.3Vout 5Vout 12Vout 15Vout 24Vout
			3.7VDC min. / 5VDC max. 5.6VDC min. / 7VDC max. 13.5VDC min. / 16VDC max. 18.3VDC min. / 22VDC max. 29.1VDC min. / 34.5VDC max.
		Dual	5Vout 12Vout 15Vout
			5.6VDC min. / 7VDC max. 13.5VDC min. / 18.2VDC max. 17VDC min. / 22VDC max.
Isolation Voltage	I/P to O/P working voltage		5kVAC / 1 minute 250VAC / continuous
Isolation Capacitance			12pF typ. / 17pF max.
Leakage Current	240VAC, 60Hz		2µA
Insulation Grade			reinforced
Means of Protection			2MOPP
Medical Device Classification			built-in power supply
Internal Clearance and Creepage	I/P to O/P		≥8mm
External Clearance and Creepage	I/P to O/P	"C" Pinning	>19.72mm
		"A" Pinning	>14.64mm

**Notes:**

Note5: This Power module is not internally fused. A input line fuse must be always used

Recommended Fuse:

2:1 Input Voltage	Fuse (slow blow)
5V	T2.5A
12V	T1.25A
24V	T0.63A
48V	T0.315A

4:1 Input Voltage	Fuse (slow blow)
24V	T1.25A
48V	T0.63A

ENVIRONMENTAL			
Parameter	Condition		Value
Maximum Case Temperature Range			-40°C to +105°C
Maximum Ambient Temperature Range			see <b>"Thermal Calculation"</b> below
Temperature Coefficient			0.02%/K typ.
Thermal Impedance	natural convection 0.1m/s		18K/W
Operating Altitude			5000m
Operating Humidity	non-condensing		5% - 95% RH max.
Pollution Degree			PD2
MTBF	according to MIL-HDBK-217F, G.B.	+25°C	4718 x 10 <sup>3</sup> hours
Thermal Shock			according to MIL-STD-810F standard
Vibration			according to MIL-STD-810F standard

continued on next page

Specifications (measured @ Ta= 25°C, nominal input voltage, full load and after warm-up)

### Thermal Calculation

$$\eta_{set} = \eta_{full\ load} \times f_{\eta}$$

$$P_{diss} = \left[ \frac{P_{out\ set}}{\eta_{set}} \right] - P_{out\ set}$$

$$T_{over} = R_{th} \times P_{diss}$$

$$T_{amb} = T_{case} - T_{over}$$

$T_{case}$	= baseplate temperature	[°C]
$T_{over}$	= temperature losses	[°C]
$T_{amb}$	= ambient temperature	[°C]
$P_{out\ nom.}$	= nom. output power	[W]
$P_{out\ set}$	= output power set	[W]
$P_{diss}$	= internal losses	[W]
$R_{th}$	= thermal impedance	[K/W]
$\eta_{set}$	= efficiency set	[%]
$\eta_{full\ load}$	= efficiency @ full load	[%]
$f_{\eta}$	= efficiency factor	[ ]

### Efficiency Crosstable (%) @ full Load

		Input Voltage					
		5	12	24	48	24W	48W
Output Voltage	3.3S	81.5	83.5	83	82.5	83	82.5
	05S	86	86	86	86.5	86	86.5
	12S	86	89	89	88	89	88
	15S	87.5	88.5	89	88.5	89	88.5
	24S	87	88.5	88.5	88	88.5	88
	05D	84	85	85	85	85	85
	12D	86.5	89	88.5	88	88.5	88
	15D	87.5	88	88.5	87	88.5	87

### Efficiency Factor vs. Load

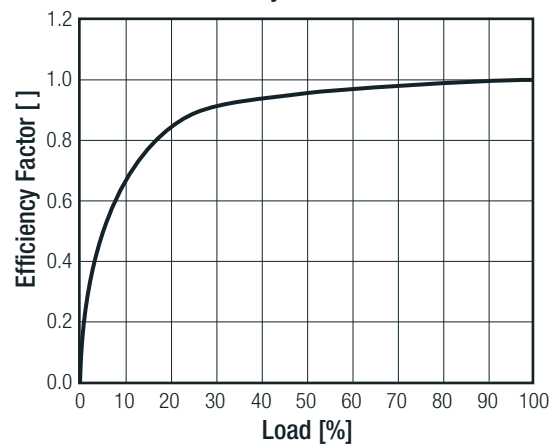

### Practical Example:

Take the REM6-1212D with 12V Input Voltage, 50% load.  
What is the maximum ambient operating temperature?

$T_{case}$	= 105°C	$\eta_{set} = 89 \times 0.96$	<b>85.44%</b>
$P_{out\ nom.}$	= 6W	$P_{diss} = \left[ \frac{3}{0.854} \right] - 3 =$	<b>0.51W</b>
$P_{out\ set}$	= 6 x 0.5 = 3W		
$R_{th}$	= 18K/W	$T_{over} = 18 \times 0.51 =$	<b>+9.2°C</b>
$\eta_{full\ load}$	= 89% (Crosstable)	$T_{amb} = 105 - 9.2 =$	<b>+95.8°C</b>
$f_{\eta}$	= 0.96 (Graph)		

### SAFETY AND CERTIFICATIONS

Certificate Type (Safety)	Report / File Number	Standard
Medical Electric Equipment, General Requirements for Safety and Essential Performance	E314885-A6-CB-1	CAN/CSA-C22.2 No. 60601-1:08 ANSI/AAMI ES60601-1:2005
Medical Electric Equipment, General Requirements for Safety and Essential Performance (CB Scheme)	E314885-A6-CB-1	IEC60601-1:2005 + C2:2007 3rd Edition EN60601-1:2006
EAC	RU-AT.49.09571	TP TC 004/2011 TP TC 004/2011
RoHS2+		RoHS-2011/65/EU + AM-2015/863

continued on next page

**Specifications (measured @ Ta= 25°C, nominal input voltage, full load and after warm-up)**

Certificate Type (Others)	Conditions	Standard / Criterion
Medical electrical equipment - Part 1-2: General requirements for basic safety and essential performance - Collateral standard: Electromagnetic compatibility - Requirements and tests		EN60601-1-2:2015
Industrial, scientific and medical equipment - Radio frequency disturbance characteristics - Limits and methods of measurement <sup>(7)</sup>		EN55011:2009 + A1:2010 Class A & B
ESD Electrostatic discharge immunity test	Air ±15kV; Contact ±8kV	EN61000-4-2:2008
Radiated, radio-frequency, electromagnetic field immunity test	10V/m (80-2500MHz) 27V/m (385MHz) 28V/m (450MHz)	EN61000-4-3:2006 + A2:2010
Fast Transient and Burst Immunity <sup>(6)</sup>	DC Port: ±2kV	EN61000-4-4:2012
Surge Immunity <sup>(6)</sup>	DC Port: ±2kV	EN61000-4-5:2005
Immunity to conducted disturbances, induced by radio-frequency fields	6Vr.m.s	EN61000-4-6:2013
Power Frequency Magnetic Field	30A/m	EN61000-4-8:2009

**Notes:**

Note6: An external input filter capacitor is required if the model has to meet EN61000-4-4 or/and EN61000-4-5

<u>Recommended components:</u>	5Vin	aluminium capacitor (Nippon Chemi-con KY series, 1000µF/25V) and a reverse diode (Vishay V10P45) to connect in parallel
	12Vin, 24Vin	aluminium capacitor (Nippon Chemi-con KY series, 470µF/50V)
	48Vin	aluminium capacitor (Nippon Chemi-con KY series, 330µF/100V)

Note7: The whole REM6 series can meet EMI Class A with no external filter. And Class B only with external components

**EMC Filter Suggestion for Class B <sup>(8)</sup>**

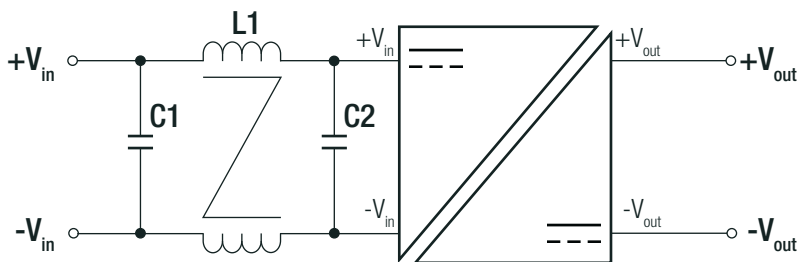

MODEL	C1 <sup>(8)</sup>	C2 <sup>(8)</sup>	L1 <sup>(8)</sup>
REM6-05xxS_D	22µF/16V MLCC	22µF/16V MLCC	137µH CMC
REM6-12xxS_D REM6-24xxS_D(W)	4.7µF/50V MLCC	4.7µF/50V MLCC	227µH CMC
REM6-48xxS_D(W)	2.2µF/100V MLCC	1µF/100V MLCC	419µH CMC

**Notes:**

Note8: The component values can be adapted according to customer's application

**DIMENSION and PHYSICAL CHARACTERISTICS**

Parameter	Type	Value
Material	case	non-conductive black plastic (UL94-V2)
	PCB	FR4 (UL94-V1)
	potting	silicone (UL94-V0)
Dimension (LxWxH)		31.80 x 20.30 x 10.40mm
Weight		14g

continued on next page

Specifications (measured @ Ta= 25°C, nominal input voltage, full load and after warm-up)

### Dimension Drawing (mm)



#### “A” Pinning (Standard)

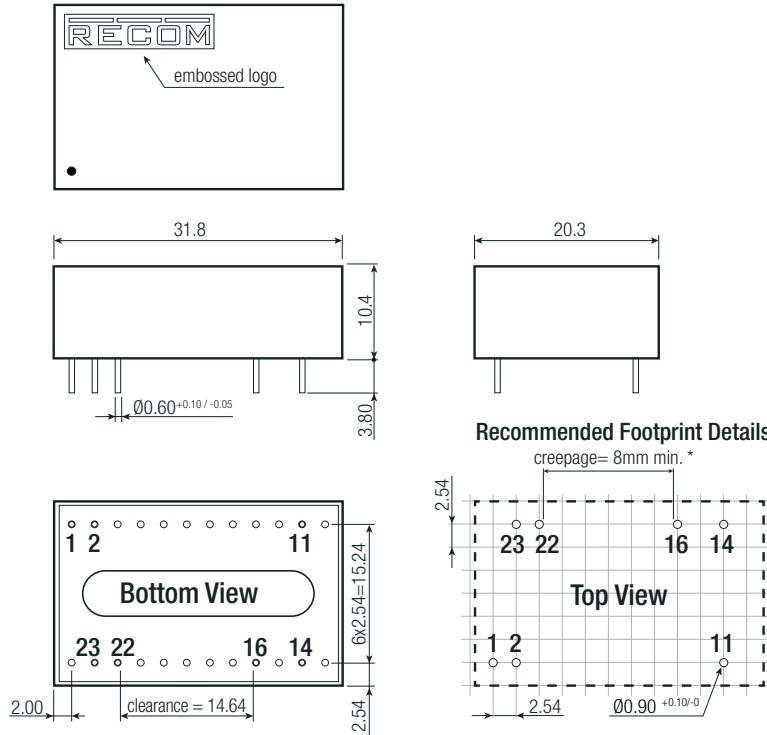

#### Pin Connections

Pin #	Single	Dual
1	CTRL*	CTRL*
2	-Vin	-Vin
11	NC	-Vout
14	+Vout	+Vout
16	-Vout	Com
22	+Vin	+Vin
23	+Vin	+Vin

\* If the CTRL option is not chosen, Pin 1 will be absent

NC= not connected  
Tolerance: xx.x= ±0.5mm  
xx.xx=±0.25mm

\*A minimum of 8mm clearance and creepage is required between primary and secondary circuit to meet 2MOPP under IEC60601-1. No copper traces and/or components are allowed in this area if 2MOPP is required.

#### “C” Pinning

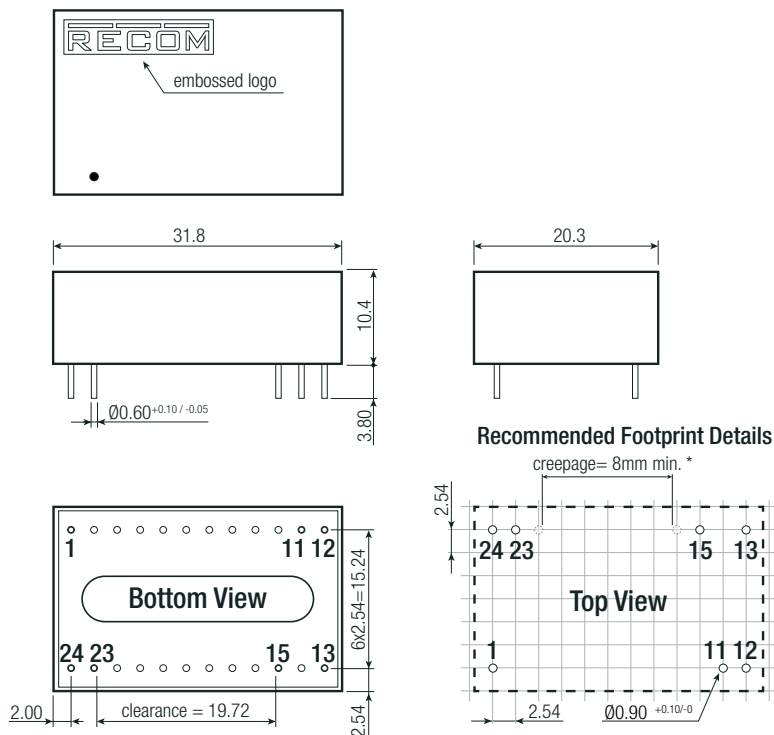

#### Pin Connections

Pin #	Single	Dual
1	+Vin	+Vin
11	No Pin	Com
12	-Vout	No Pin
13	+Vout	-Vout
15	No Pin	+Vout
23	-Vin	-Vin
24	-Vin	-Vin

Tolerance: xx.x= ±0.5mm  
xx.xx= ±0.25mm

\*A minimum of 8mm clearance and creepage is required between primary and secondary circuit to meet 2MOPP under IEC60601-1. No copper traces and/or components are allowed in this area if 2MOPP is required.

Specifications (measured @ Ta= 25°C, nominal input voltage, full load and after warm-up)

PACKAGING INFORMATION		
Parameter	Type	Value
Packaging Dimension (LxWxH)	tube	255 x 21.8 x 16.5mm
Packaging Quantity		7pcs
Storage Temperature Range		-55°C to +125°C
Storage Humidity	non-condensing	5% to 95% RH max.

Tube Dimension Drawing (mm)

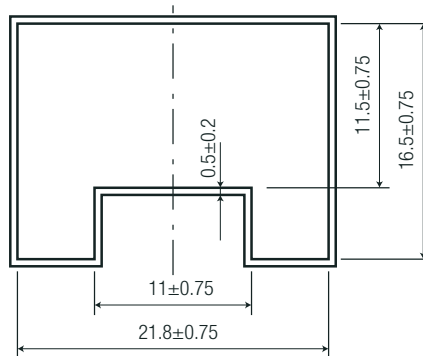

The product information and specifications may be subject to changes even without prior written notice. The product has been designed for various applications; its suitability lies in the responsibility of each customer. The products are not authorized for use in safety-critical applications without RECOM's explicit written consent. A safety-critical application is an application where a failure may reasonably be expected to endanger or cause loss of life, inflict bodily harm or damage property. The applicant shall indemnify and hold harmless RECOM, its affiliated companies and its representatives against any damage claims in connection with the unauthorized use of RECOM products in such safety-critical applications.

## X-ON Electronics

Largest Supplier of Electrical and Electronic Components

*Click to view similar products for [Isolated DC/DC Converters](#) category:*

*Click to view products by [RECOM POWER](#) manufacturer:*

Other Similar products are found below :

[ESM6D044440C05AAQ](#) [FMD15.24G](#) [PSL486-7LR](#) [PSR152.5-7IR](#) [Q48T30020-NBB0](#) [AVO240-48S12B-6L](#) [AVO250-48S28B-6L](#) [NAN-0505](#) [HW-L16D](#) [JAHW100Y1](#) [217-1617-001](#) [22827](#) [SPB05C-12](#) [SQ24S15033-PS0S](#) [18952](#) [19-130041](#) [CE-1003](#) [CE-1004](#) [GQ2541-7R](#) [PSE1000DCDC-12V](#) [RDS180245](#) [MAU228](#) [419-2065-201](#) [449-2075-101](#) [V300C24C150BG](#) [419-2062-200](#) [419-2063-401](#) [419-2067-101](#) [419-2067-501](#) [419-2068-001](#) [DFC15U48D15](#) [449-2067-000](#) [XGS-0512](#) [XGS-1205](#) [XGS-1212](#) [XGS-2412](#) [XGS-2415](#) [XKS-1215](#) [033456](#) [NCT1000N040R050B](#) [SPB05B-15](#) [SPB05C-15](#) [VI-26B-CU](#) [V24C12C100BG](#) [L-DA20](#) [HP3040-9RG](#) [HP1001-9RTG](#) [DCG40-5G](#) [XKS-2415](#) [XKS-2412](#)