

Features

- 3kVDC/1s or 4kVDC/1s isolation
- Optional continuous short circuit protection
- UL94V-0 package material
- Efficiency up to 84%
- Suitable for IGBT applications

Unregulated Converters

RK & RH

1 Watt
SIP7
Single and Dual Output

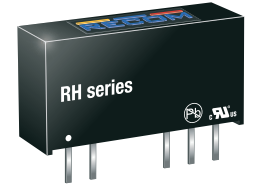
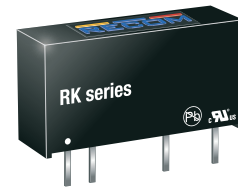

UL60950-1 certified
 CSA/CAN C22.2 No. 60950-1-07 certified
 IEC/EN60950-1 certified
 IEC/EN60601-1 certified*
 EN55032 compliant

*+15/-9 version excluded

Description

The RK and RH Series DC/DC-Converter complements RECOM's industrial range of converters with very high isolations of 3kVDC/1s and 4kVDC/1s. The extended operating temperature range covering -40°C to +90°C is a standard feature. The converters are IEC/EN/UL60950-1 certified, and are suitable for IGBT driver applications.

Selection Guide

Part Number	nom. Input Voltage [VDC]	Output Voltage [VDC]	Output Current [mA]	Efficiency typ. ⁽¹⁾ [%]	Max. Capacitive Load ⁽²⁾ [µF]
RK-xx05S ^(3,4)	5, 12, 15, 24	5	200	70-78	1000
RK-xx09S ^(3,4)	5, 12, 15, 24	9	111	70-80	1000
RK-xx12S ^(3,4)	5, 12, 15, 24	12	84	78-82	470
RK-xx15S ^(3,4)	5, 12, 15, 24	15	66	80-82	470
RH-xx05D ^(3,4)	5, 12, 15, 24	±5	±100	74-78	±470
RH-xx09D ^(3,4)	5, 12, 15, 24	±9	±56	76-79	±470
RH-xx12D ^(3,4)	5, 12, 15, 24	±12	±42	78-84	±220
RH-xx15D ^(3,4)	5, 12, 15, 24	±15	±33	80-84	±220
RH-xx1509D ^(3,4)	5, 12, 24	+15/-9	+33/-56	70-81	+220/-470µF

Notes:

Note1: Efficiency is tested at nominal input and full load at +25°C ambient

Note2: Max Cap Load is tested at nominal input and full resistive load and is defined as the capacitive load that will allow start up in under 1s without damage to the converter

Model Numbering

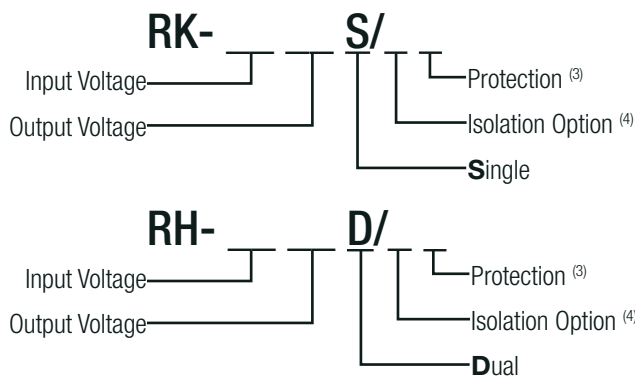

Notes:

Note3: standard part is without Continuous Short Circuit Protection

add suffix „/P“ for Continuous Short Circuit Protection

Note4: add suffix „/H“ for 4kVDC/1s Isolation

or add suffix „/HP“ for Continuous Short Circuit Protection and 4kVDC/1s Isolation

Ordering Examples:

RH-123.3D/P: 12V Input Voltage, ±3.3V Output Voltage, Dual Output with continuous short circuit protection

RK-0509S/HP: 5V Input Voltage, 9V Output Voltage, Single Output with 4kVDC/1s Isolation and continuous short circuit protection

Specifications (measured @ Ta= 25°C, nom. Vin, full load unless otherwise stated)

BASIC CHARACTERISTICS

Parameter	Condition	Min.	Typ.	Max.
Internal Input Fuse				capacitors
Input Voltage Range			±10%	
Minimum Load		0%		
Start-up Time				250ms
Internal Operating Frequency		50kHz	100kHz	105kHz
Output Ripple and Noise	20MHz BW			100mVp-p

Efficiency vs. Load

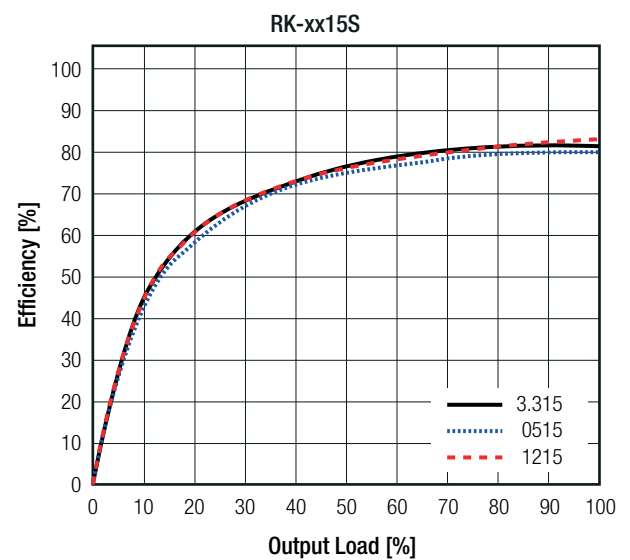
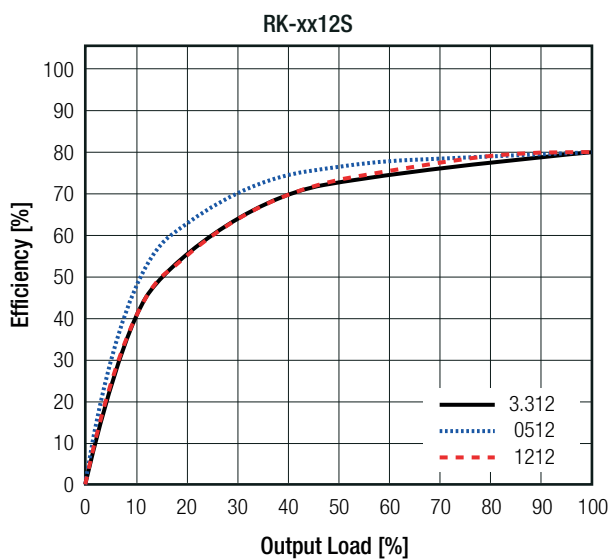
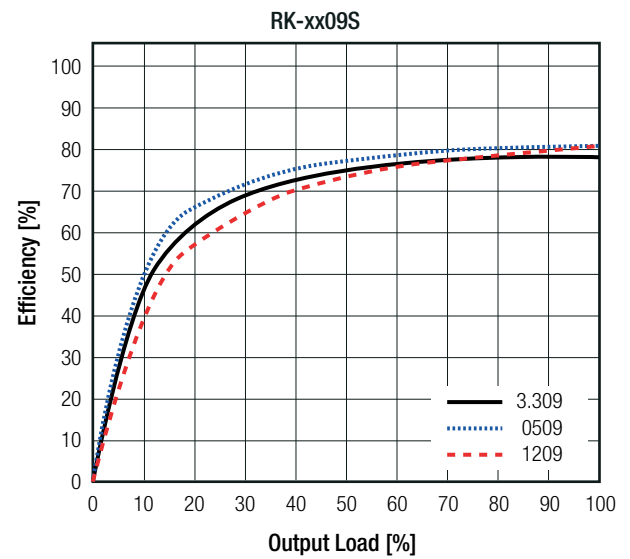
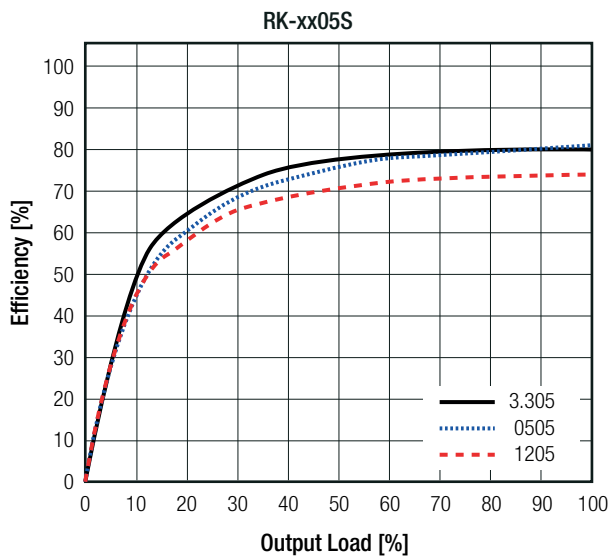

Specifications (measured @ Ta= 25°C, nom. Vin, full load unless otherwise stated)

Efficiency vs. Load

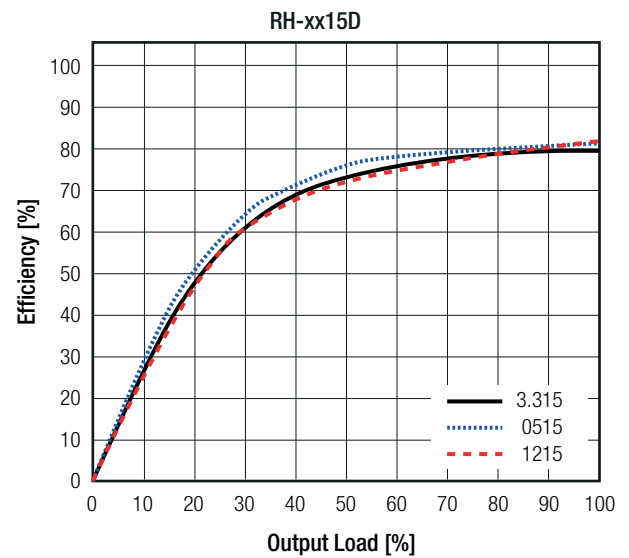
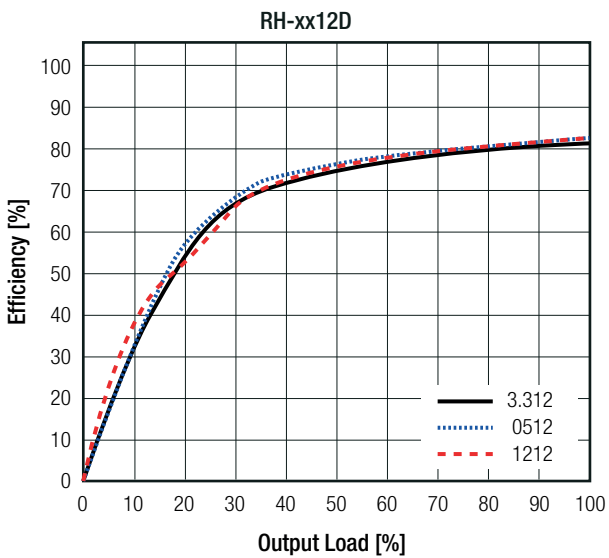
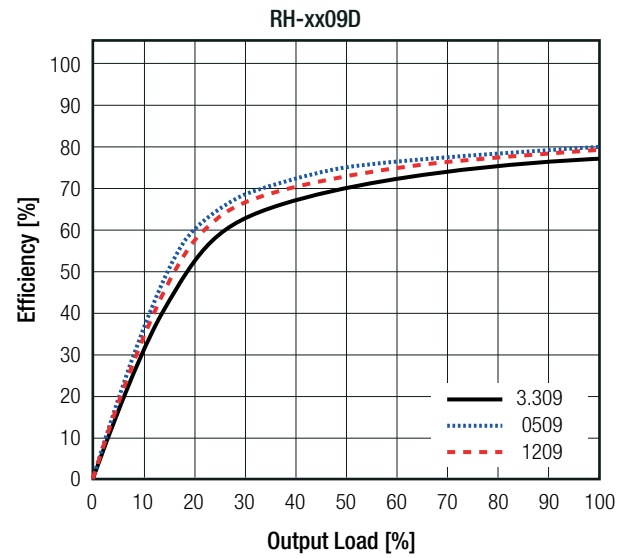
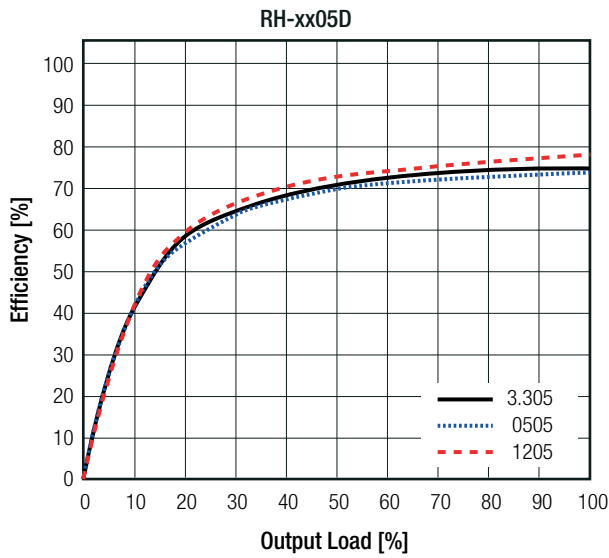

REGULATIONS

Parameter	Condition		Values
Output Accuracy			±5.0% max.
Line Regulation	low line to high line		±1.2% of 1.0% Vin typ.
Load Regulation ⁽⁵⁾	10% to 100% load	5Vout	15.0% max.
		9, 12, 15Vout and RH-xx1509D	10.0% max.

Notes:

Note5: Operation below 10% load will not harm the converter, but specifications may not be met

continued on next page

Specifications (measured @ Ta= 25°C, nom. Vin, full load unless otherwise stated)

Deviation vs. Load

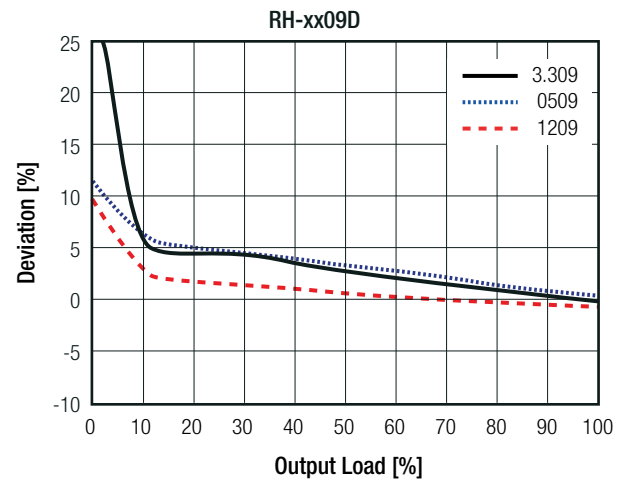
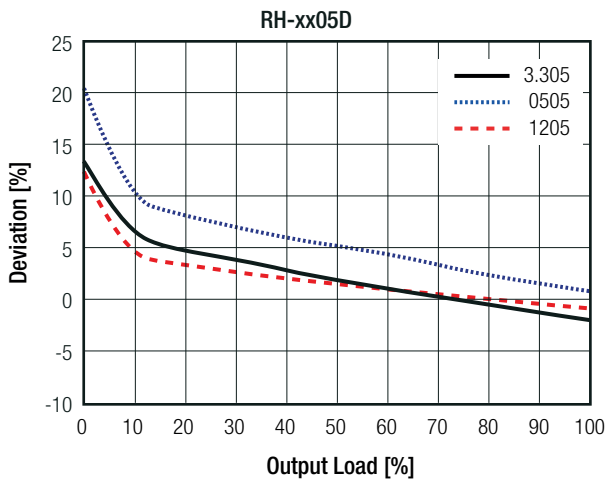
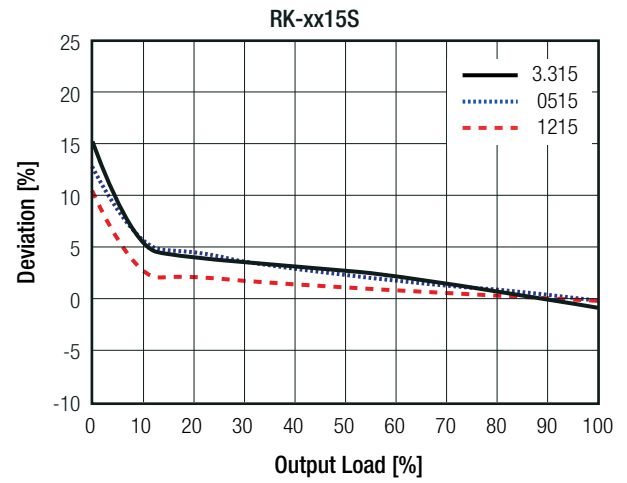
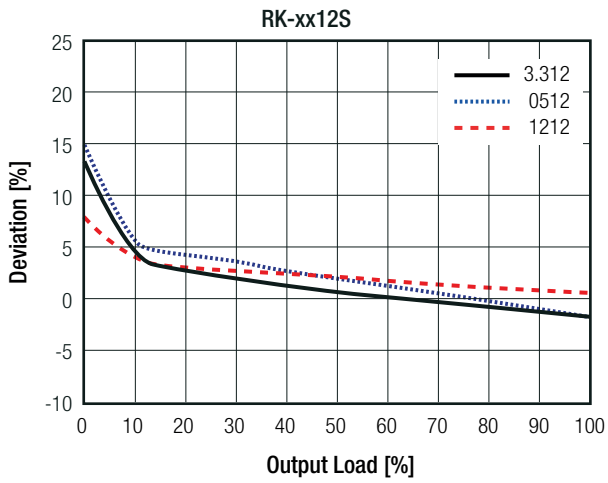
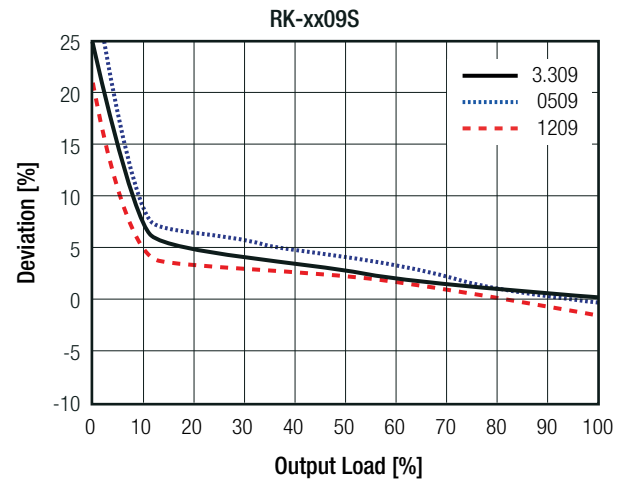
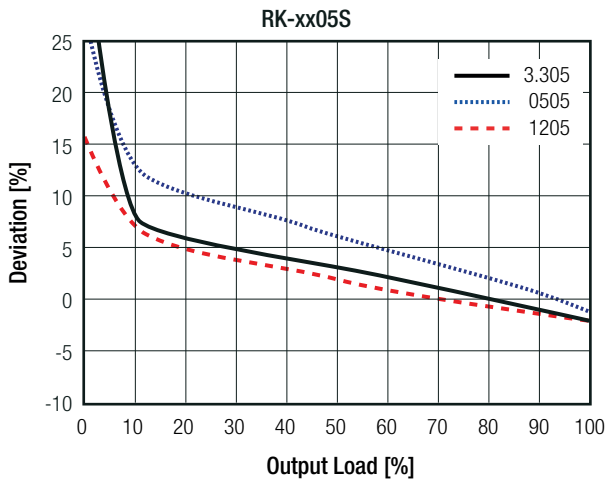

continued on next page

Specifications (measured @ Ta= 25°C, nom. Vin, full load unless otherwise stated)

Deviation vs. Load

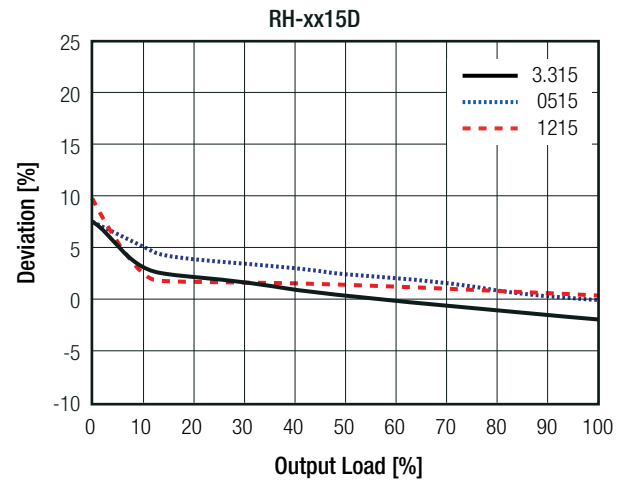
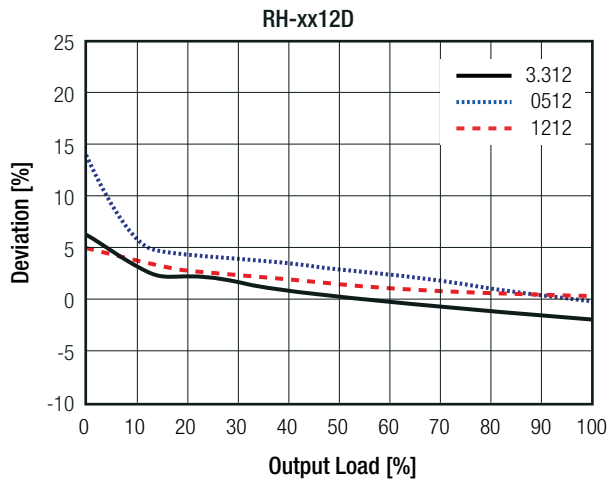

PROTECTIONS

Parameter	Condition		Value
Short Circuit Protection (SCP)	without suffix with suffix "/P"		1 second continuous
Isolation Voltage ⁽⁶⁾	I/P to O/P	without suffix	tested for 1 second rated for 1 minute 3kVDC 1.5kVAC
		with suffix "/H"	tested for 1 second rated for 1 minute 4kVDC 2kVAC
Isolation Capacitance	RK types RH types		20pF min. / 75pF max. 20pF min. / 65pF max.
Isolation Resistance			15GΩ min.
Insulation Grade			basic (IEC/EN60950-1) functional (IEC/EN60601-1)

Notes:

Note6: For repeat Hi-Pot testing, reduce the time and/or the test voltage

Note7: Refer to local safety regulations if input over-current protection is also required. Recommended fuse: slow blow type

ENVIRONMENTAL

Parameter	Condition		Value	
Operating Temperature Range	full load @ free air convection (see graph)		-40°C to +90°C	
Operating Altitude			3000m	
Operating Humidity	non-condensing		5% - 95% RH max.%	
Pollution Degree			PD2	
MTBF	according to MIL-HDBK-217F; G.B.	RK type	+25°C	992 x 10 ³ hours
			+85°C	145 x 10 ³ hours
		RH type	+25°C	1012 x 10 ³ hours
			+85°C	151 x 10 ³ hours

continued on next page

Specifications (measured @ Ta= 25°C, nom. Vin, full load unless otherwise stated)

Derating Graph
(@ free air convection)

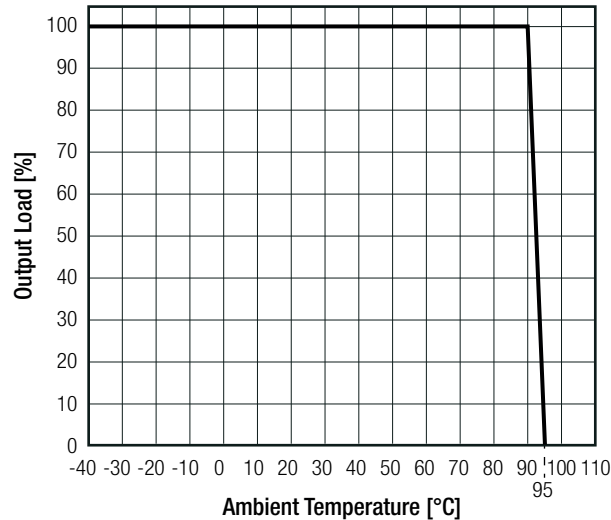

SAFETY AND CERTIFICATIONS

Certificate Type (Safety)	Report / File Number	Standard
Information Technology Equipment, General Requirements for Safety	E358085-A4-UL	UL60950-1, 2nd Edition:2007 CAN/CSA C22.2 No. 60950-1-03, 2nd Edition:2007
Information Technology Equipment, General Requirements for Safety	SPCLVD1602031	IEC60950-1:2005, 2nd Edition + A2:2013 EN60950-1:2006 + A2:2013
Medical electrical equipment Part 1: General requirements for basic safety and essential performance	WD-SE-R-180676-A0 ^(®)	IEC60601-1:2005 + A1:2012, 3rd Edition EN60601-1:2006 + A1:2013 + A12:2014
EAC	RU-AT.49.09571	TP TC 004/2011
RoHS 2		RoHS-2011/65/EU + AM-2015/863

EMC Compliance	Condition	Standard / Criterion
Electromagnetic compatibility of multimedia equipment - Emission requirements	with external filter (see filter suggestion below)	EN55032, Class B EN55032, Class A

Notes:

Note8: excluded +15/-9 version

EMC Filter Suggestion according to EN55032
Single Output

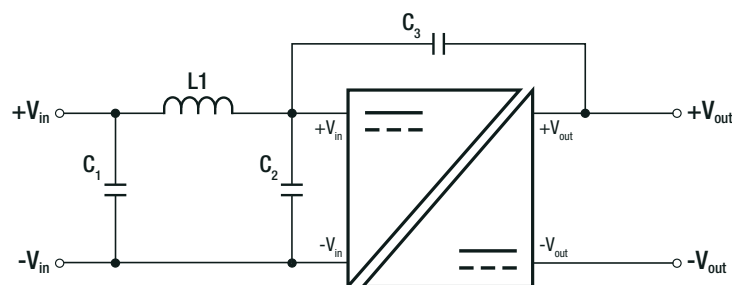

Component List Class A

MODEL	C1	L1	C2	C3
RK-0505S	10µF 100V MLCC	N/A	N/A	N/A
RK-0515S		22µH choke RLS-226		
RK-2405S		12µH choke RLS-126		

Component List Class B

MODEL	C1	L1	C2	C3
RK-0505S	10µF 100V MLCC	12µH choke RLS-126	4.7µF 50V MLCC	N/A
RK-0515S				2.2nF
RK-2405S				N/A

Notes:

Note9: Filter suggestions are valid for indicated part numbers only. For other part numbers, please contact RECOM tech support for advice

Specifications (measured @ Ta= 25°C, nom. Vin, full load unless otherwise stated)

DIMENSION and PHYSICAL CHARACTERISTICS

Parameter	Type	Value
Material	case potting	non-conductive black plastic, (UL94 V-0) epoxy, (UL94 V-0)
Dimension (LxWxH)	standard with suffix "/H"	19.65 x 6.0 x 10.2mm 19.65 x 7.05 x 10.2mm
Weight	standard with suffix "/H"	2.6g typ. 2.8g typ.

Dimension Drawing (mm)

Standard Version

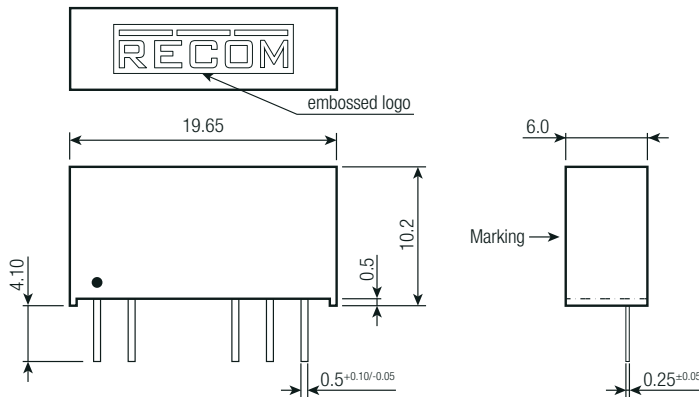

Pinning Information

Pin #	Single	Dual
1	+Vin	+Vin
2	-Vin	-Vin
5	-Vout	-Vout
6	no pin	Com
7	+Vout	+Vout

Tolerance: xx.x= ±0.5mm
xx.xx= ±0.25mm

Recommended Footprint

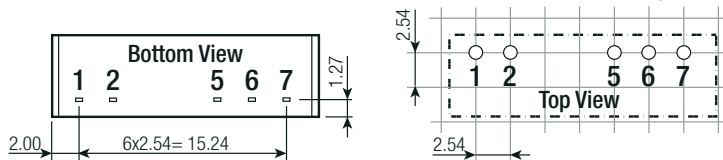

„H“ - Version

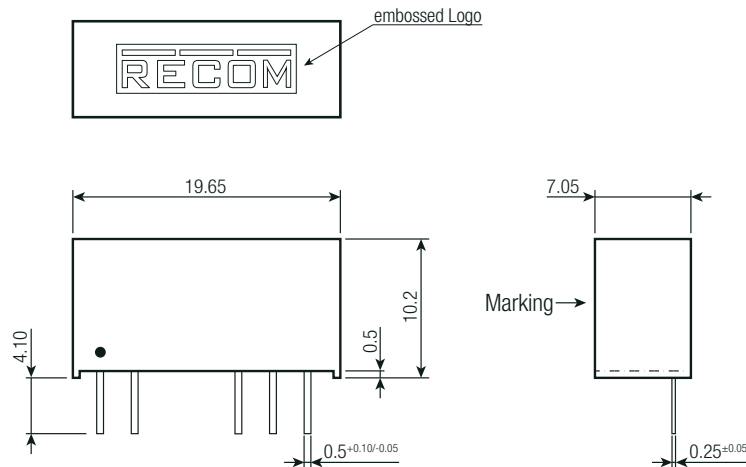

Pinning Information

Pin #	Single	Dual
1	+Vin	+Vin
2	-Vin	-Vin
5	-Vout	-Vout
6	no pin	Com
7	+Vout	+Vout

Tolerance: xx.x= ±0.5mm
xx.xx= ±0.25mm

Recommended Footprint

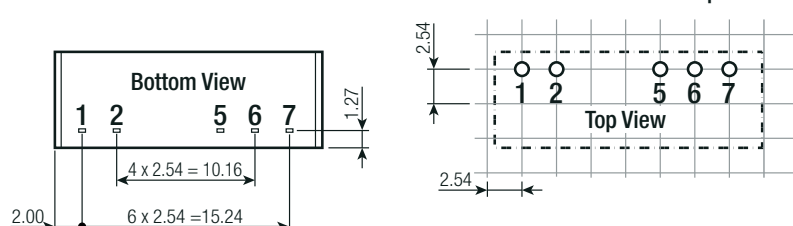

Specifications (measured @ Ta= 25°C, nom. Vin, full load unless otherwise stated)

INSTALLATION AND APPLICATION

IGBT Application Circuit

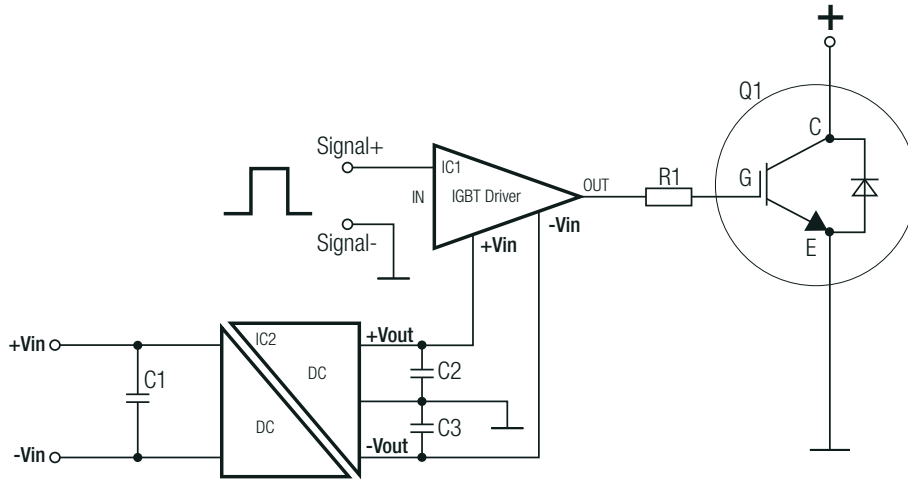

PACKAGING INFORMATION

Parameter	Type	Value
Packaging Dimension (LxWxH)	tube	520.0 x 16.0 x 9.0mm
Packaging Quantity	tube	25pcs
Storage Temperature Range		-55°C to +125°C
Storage Humidity	non-condensing	95% RH max.

The product information and specifications may be subject to changes even without prior written notice. The product has been designed for various applications; its suitability lies in the responsibility of each customer. The products are not authorized for use in safety-critical applications without RECOM's explicit written consent. A safety-critical application is an application where a failure may reasonably be expected to endanger or cause loss of life, inflict bodily harm or damage property. The applicant shall indemnify and hold harmless RECOM, its affiliated companies and its representatives against any damage claims in connection with the unauthorized use of RECOM products in such safety-critical applications.

X-ON Electronics

Largest Supplier of Electrical and Electronic Components

Click to view similar products for [Isolated DC/DC Converters](#) category:

Click to view products by [Recom Power](#) manufacturer:

Other Similar products are found below :

[ESM6D044440C05AAQ](#) [FMD15.24G](#) [PSL486-7LR](#) [Q48T30020-NBB0](#) [JAHW100Y1](#) [SPB05C-12](#) [SQ24S15033-PS0S](#) [18952](#) [19-130041](#)
[CE-1003](#) [CE-1004](#) [GQ2541-7R](#) [RDS180245](#) [MAU228](#) [J80-0041NL](#) [DFC15U48D15](#) [XGS-0512](#) [XGS-1205](#) [XGS-1212](#) [XGS-2412](#) [XGS-](#)
[2415](#) [XKS-1215](#) [06322](#) [NCT1000N040R050B](#) [SPB05B-15](#) [SPB05C-15](#) [L-DA20](#) [DCG40-5G](#) [QME48T40033-PGB0](#) [XKS-2415](#) [XKS-2412](#)
[XKS-1212](#) [XKS-1205](#) [XKS-0515](#) [XKS-0505](#) [XGS-2405](#) [XGS-1215](#) [XGS-0515](#) [PS9Z-6RM4](#) [73-551-5038I](#) [AK1601-9RT](#) [VI-N61-CM](#) [VI-](#)
[R5022-EXWW](#) [PSC128-7iR](#) [RPS8-350ATX-XE](#) [DAS1004812](#) [PQA30-D24-S24-DH](#) [VI-M5F-CQ](#) [VI-LN2-EW](#) [VI-PJW01-CZY](#)