

RMOD600-EW Series / Plug & Play E-Mobility

600W / Extra-Wide Input 33.6V - 125VDC

FEATURES

- On-Board DC/DC Converter
- E-Mobility and industry vehicles
- Very wide input voltage range for 48V / 80V / 96V
- Plug & Play, ready to use
- Chassis mount and base plate cooled
- Full power at ambient temperature up to 85°C
- Water and dust proof (IP69K), robust and reliable
- High and extremely constant efficiency
- Parallel operation without active current sharing
- High power density
- 2 years warranty



Dimensions (LxWxH): 203.0 x 115.0 x 71.0mm (8.0 x 4.53 x 2.8 inch)
2800g (6.17 lbs)

APPLICATIONS

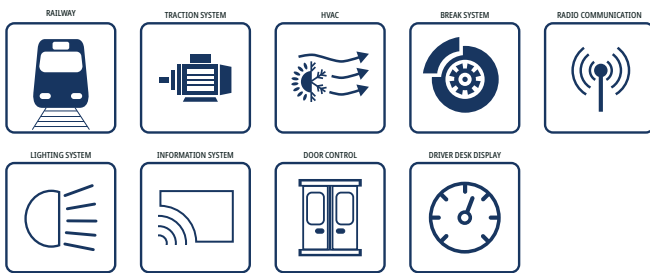

SAFETY & EMC



DESCRIPTION

The RMOD families are extremely robust plug & play modules which are used to generate the low voltage network from a vehicle's traction battery. The ultra-wide input voltage range up to 125VDC covers all common battery voltages in the off-highway vehicle (OHV) segment. Thanks to the waterproof and dust proof housing construction, the devices can be connected mechanically and thermally directly to the chassis, i.e., at any point on the vehicle, and will therefore operate reliably even under the most adverse conditions. This solution is ideal for electric vehicles with nominal 48V...96V battery-powered systems in "Off-Highway E-Mobility Applications" such as Material Handling, Forklift trucks, Golf cars, AGVs, Loaders, Construction vehicles, Airport equipment, People mover, Special vehicles, Transporters, Tractors, etc.

SELECTION GUIDE

Part Number	Input Voltage	Output Voltage	Output Current	Efficiency	Output Power
	Range [VDC]	nom. [VDC]	max. [A]	typ. ⁽¹⁾ [%]	max. [W]
RMOD600-80-13SEW	33.6-125	13	46.2	85	600

Note1: Efficiency is tested at nominal input and 50%-100% +25°C ambient

MODEL NUMBERING

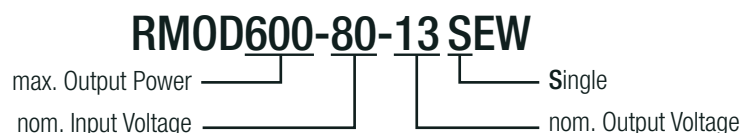

RMOD600-EW Series / Plug & Play E-Mobility

600W / Extra-Wide Input 33.6V - 125VDC

BASIC CHARACTERISTICS (measured @ $T_{AMB} = 25^{\circ}C$, nom. V_{IN} , full load and after warm-up unless otherwise stated)

Parameter	Conditions	Min.	Typ.	Max.
Input Voltage Range	refer to „Input Voltage Range“	nom. $V_{IN} = 48, 80, 96VDC$	33.6VDC	125VDC
		Extendend range: 5 minutes max.	24VDC	33.6VDC
Input Current				32A
Inrush Current				1.5A ² s
Quiescent Current	nom. $V_{IN} = 80VDC$			75mA
Typical Output Voltage	$V_{IN} = 24-33.6VDC$	12.5VDC		
	$V_{IN} = 33.6-125VDC$		13VDC	
Minimum Load		0%		
Start-up time			300ms	500ms
Rise time			100ms	
Internal Operating Frequency	BOOST stage		100kHz	
	MAIN power stage		200kHz	
	auxiliary		300kHz	
Output Ripple and Noise				500mVp-p

Input Voltage Range

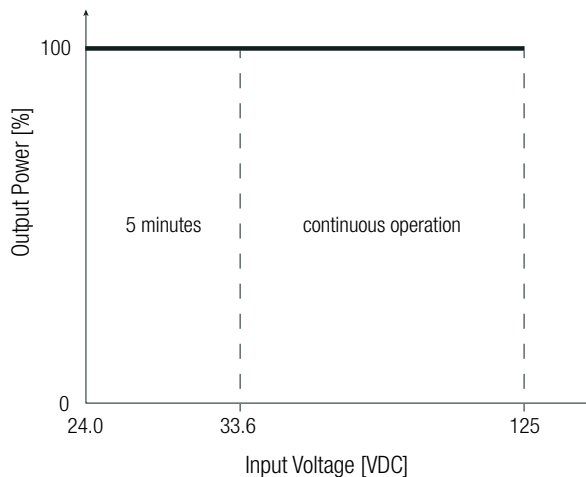

Efficiency vs. Load

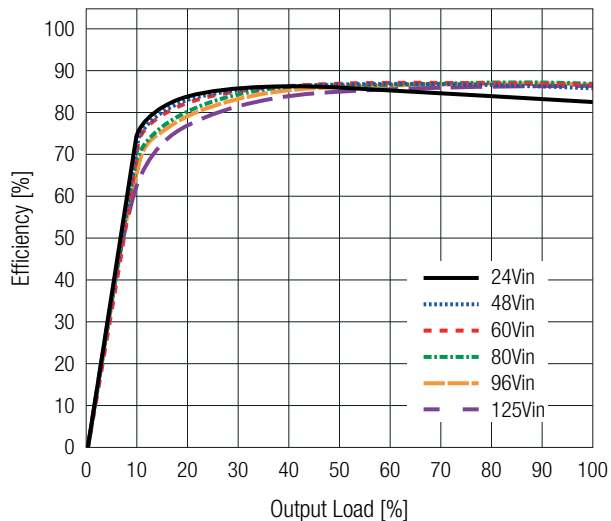

Power Dissipation vs. Load

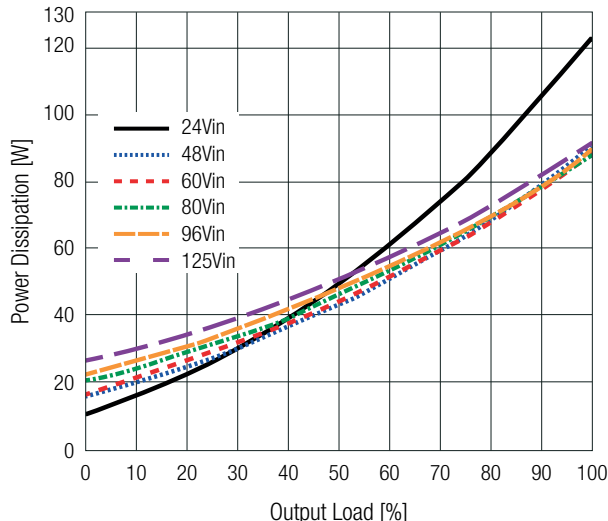

REGULATIONS (measured @ $T_{AMB} = 25^{\circ}C$, nom. V_{IN} , full load and after warm-up unless otherwise stated)

Parameter	Conditions	Value	
Output Accuracy		$\pm 4.0\%$ max.	
Line Regulation	low line to high line, full load	$V_{IN} = 33.6-125VDC$	$\pm 1.0\%$ max.
		$V_{IN} = 24-33.6VDC$ and $96-125VDC$	$\pm 3.0\%$ max.
Load Regulation	10-90% load	2.5% typ.	
Transient Response	10-90% load, $V_{IN} = 33.6-125VDC$	1.3VDC	
	recovery time	100ms typ.	

Deviation vs. Load
(nom. V_{IN})

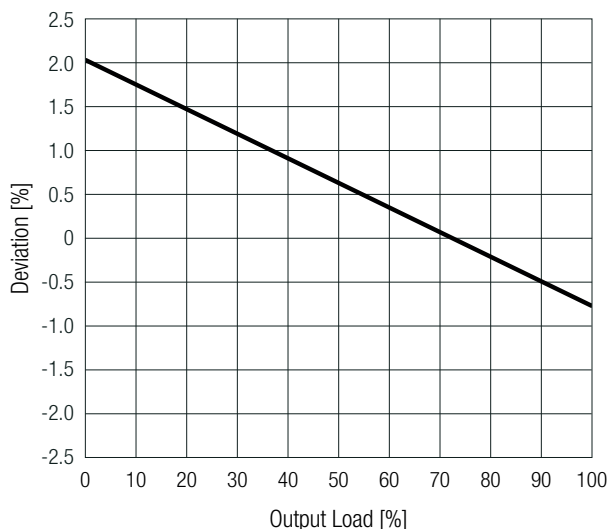

PROTECTIONS (measured @ $T_{AMB} = 25^{\circ}C$, nom. V_{IN} , full load and after warm-up unless otherwise stated)

Parameter	Type	Value
Short Circuit Protection (SCP)	auto recovery	current limitation
Input Reverse Polarity Protection	active protected	-125VDC max.
Input Short Term Over Voltage	adapted to 96VDC	according to ISO 21780 10.3
Input Long Term Over Voltage		according to ISO 21780 10.6
Decrease and Increase of Supply Voltage		according to ISO 21780 10.8
Over Current Protection (OCP)	auto recovery	88 - 0 - 88VDC for 21min 48A typ.; current limitation
Over Temperature Protection (OTP)		yes
Isolation Voltage ⁽²⁾	I/P to O/P; I/P to case; O/P to case; 1 minute	2.5kVDC
Isolation Resistance		10M Ω min.
Insulation Grade		basic

Note2: For repeated Hi-Pot testing, reduce the time and/or the test voltage

ENVIRONMENTAL (measured @ $T_{AMB} = 25^{\circ}C$, nom. V_{IN} , full load and after warm-up unless otherwise stated)

Parameter	Conditions	Value
Operating Ambient Temperature Range ⁽³⁾	refer to „Thermal Consideration“	-35 $^{\circ}C$ to +85 $^{\circ}C$
Operating Altitude		3000m
Pollution Degree		PD3
IP Rating		IP69K
MTBF	according to SR-332; $T_{AMB} = +50^{\circ}C$	1000 x 10 ³ hours

Note3: For operation above +70 $^{\circ}C$ ambient, take care about sufficient cooling (never exceed max. allowed base plate temperature = 70 $^{\circ}C$)

ENVIRONMENTAL (measured @ $T_{AMB}= 25^{\circ}C$, nom. V_{IN} , full load and after warm-up unless otherwise stated)

Thermal Consideration

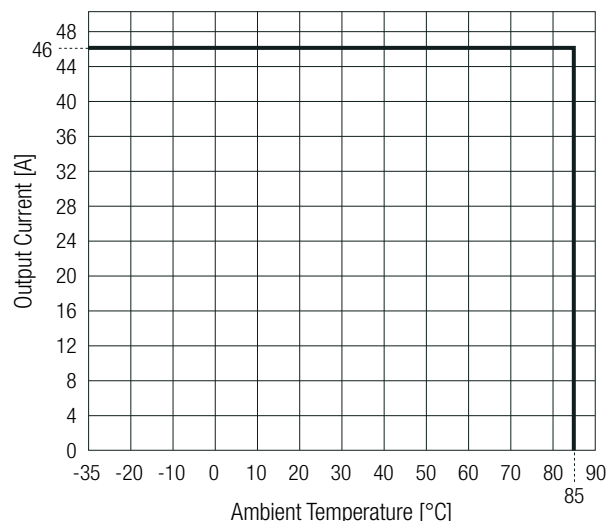
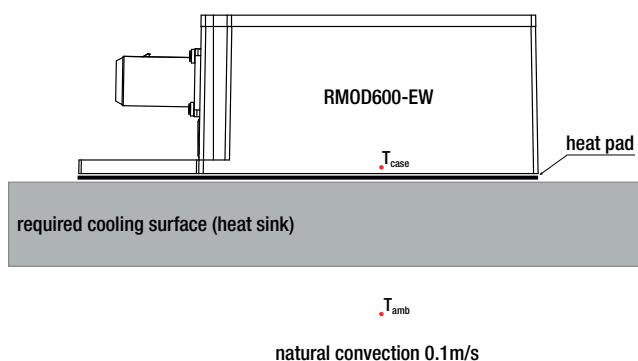

The module can be used in enclosed applications with full load, as long as the cooling is sufficient to keep the baseplate temperature at T_{CASE} below $70^{\circ}C$. The surrounding temperature should not exceed $85^{\circ}C$.

ENVIRONMENTAL

Parameter	Condition	Standard
Temperature Change	duration: 240 hours and 20 cycles minimum time at $-35^{\circ}C/85^{\circ}C < 30$ minutes	EN60068-2-14
Constant Temperature- warm	duration: 96 hours, ambient: $85^{\circ}C$	EN60068-2-2
Temperature Shock	duration: 20 cycles; operation mode: in operation test temperature: $85^{\circ}C$ test duration: 1 hour fully tempered + 15 minutes transfer duration: < 5 seconds test medium: water $0^{\circ}C$, 5% dissolved salt content time under water: 5 minutes water volumes: at least 5 times the component volume no water ingress	EN60068-2-14
Humidity/Heat Cycle	max. air temperature: $55^{\circ}C$; number of cycles: 6 operation mode: 1 hour in operation 1 hour without function air humidity: 93%; cycles duration: 24 hours temperature change $\geq 5K/min$; minimum air temperature $25^{\circ}C$	EN60068-2-30
Vibrations, Sinusoidal	shock load: 10g; frequency range: 10-500Hz length of time subject to load: 3x9 hours; number of cycles: 50 shock form: sinusoidal; operation mode: operational	EN60068-2-6
Continuous Shock	shock load: 10g, duration: 16ms number of impacts: 10000 shocks/axis	EN60068-2-29
Shock	shock load: 30g, duration: 6ms length of time subject to load: 3x6 directions	EN60068-2-27
Salt Spray	at $35^{\circ}C$ for 4 hours	EN60068-2-11

SAFETY & CERTIFICATIONS

Certificate Type (Safety)	Report Number	Standard
Audio/Video, information and communication technology equipment - Part1: Safety requirements 2nd Edition	E196683	UL62368-1:2014 2nd Edition CAN/CSA-C22.2 No. 62368-1-14 2nd Edition
Audio/Video, information and communication technology equipment - Part1: Safety requirements 2nd Edition		IEC62368-1:2014 2nd Edition EN62368-1:2014+A11:2017
RoHS2		RoHS 2011/65/EU + AM2015/863

SAFETY & CERTIFICATIONS

EMC Compliance	Condition	Standard
Industrial trucks - Electromagnetic compatibility		EN12895
Vehicles, boats and internal combustion engines - Radio disturbance characteristics - Limits and methods of measurement for the protection of on-board receivers		CISPR25 / EN55025
Fast Transient and Burst Immunity		EN61000-4-4
Road vehicles - Test methods for electrical disturbances from electrostatic discharge		ISO 10605
Road vehicles - Component test methods for electrical disturbances from narrowband radiated electromagnetic energy - Part 2: Absorber-lined shielded enclosure		ISO 11452-2
Road vehicles - Component test methods for electrical disturbances from narrowband radiated electromagnetic energy - Part 4: Harness excitation methods		ISO 11452-4
Road vehicles - Component test methods for electrical disturbances from narrowband radiated electromagnetic energy - Part 8: Immunity to magnetic fields		ISO 11452-8

DIMENSION & PHYSICAL CHARACTERISTICS

Parameter	Type	Value
Material	case	aluminum
Dimension (LxWxH)		203.0 x 115.0 x 71.0mm 8.0 x 4.53 x 2.8 inch
Weight		2800g typ. 6.17 lbs

Dimension Drawing (mm)

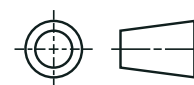

Connector Information

Connector	#	Function
DC Input CON1	1	+V _{IN}
	2	-V _{IN}
DC Output CON2	3	-V _{OUT}
	4	+V _{OUT}

FC= fixing centers

Compatible Connector

Connector	Housing
DC Input CON1	FEP 42122900
DC Output CON2	FEP 42161000

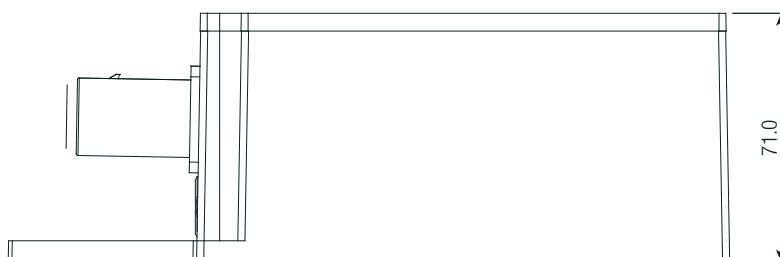
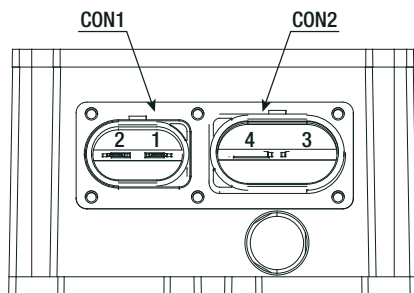
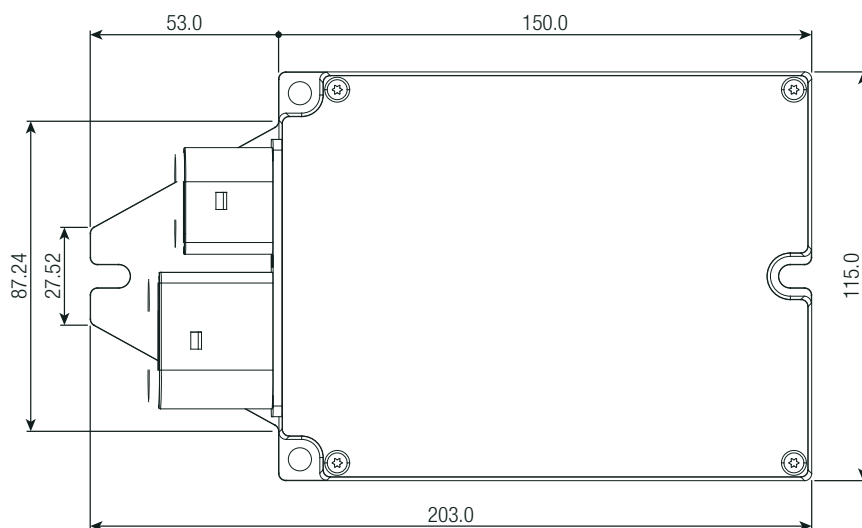

Tolerance: ±0.5mm

DIMENSION & PHYSICAL CHARACTERISTICS

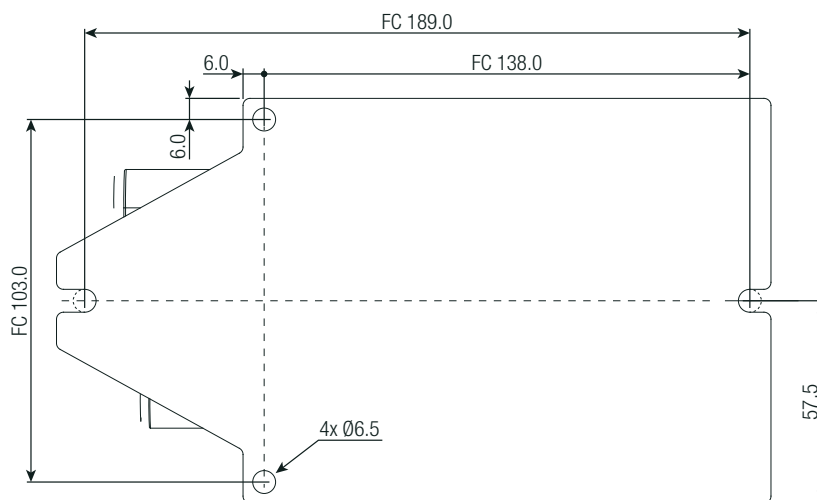

Tolerance: ±0.5mm

INSTALLATION & APPLICATION

Parallel Operation

Parallel operation is possible with all combinations of DC/DC converter versions providing they have the same rated output voltage. There is no active current sharing and therefore the units connected in parallel could be contributing different amounts to the total load current.

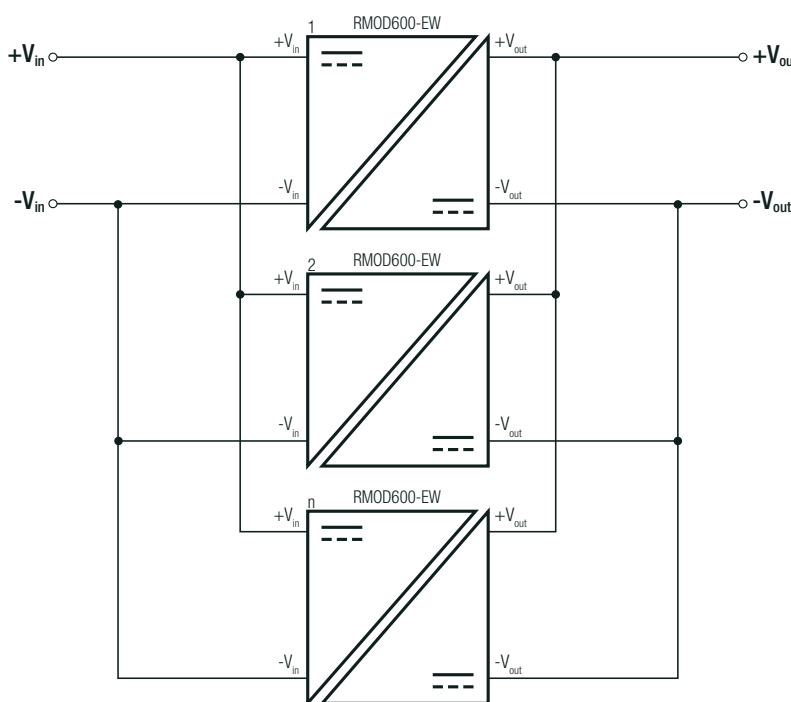

PACKAGING INFORMATION

Parameter	Type	Value
Packaging Dimension (LxWxH)	cardboard box	788.0 x 594.0 x 109.0mm
Packaging Quantity		10pcs
Storage Temperature Range		-40°C to +85°C
Storage Humidity		95% max.

The product information and specifications may be subject to changes even without prior written notice. The product has been designed for various applications; its suitability lies in the responsibility of each customer. The products are not authorized for use in safety-critical applications without RECOM's explicit written consent. A safety-critical application is an application where a failure may reasonably be expected to endanger or cause loss of life, inflict bodily harm or damage property. The applicant shall indemnify and hold harmless RECOM, its affiliated companies and its representatives against any damage claims in connection with the unauthorized use of RECOM products in such safety-critical applications.

X-ON Electronics

Largest Supplier of Electrical and Electronic Components

Click to view similar products for [Isolated DC/DC Converters - Chassis Mount](#) category:

Click to view products by [RECOM POWER](#) manufacturer:

Other Similar products are found below :

[RPS8-350ATX-XE](#) [AK-1615-7R](#) [EBC4050N042N75](#) [FK1601-7RT](#) [AM3040-9G](#) [BQ2660-9RF](#) [B62SR24125CC](#) [B40SR12424CC](#)
[VTD24SC24-O](#) [VTB05SC110-O](#) [B62SR13722AC](#) [TMDC 20-4811](#) [TMDC 20-4815](#) [TMDC 40-2411](#) [TMDC 40-4811](#) [TMDC 60-2411](#)
[TMDC 60-4815](#) [RSD-300D-5](#) [STMGFS152412](#) [TMDC 20-2411](#) [TMDC 20-2412](#) [TMDC 20-2418](#) [TMDC 60-4811](#) [TMDC 60-4812](#) [TMDC](#)
[60-4818](#) [VHK150W-Q24-S48](#) [EQ2001-9RG](#) [SD-100A-12](#) [RSD-30G-3.3](#) [RSD-30H-3.3](#) [RSD-30H-5](#) [RSD-30L-3.3](#) [RSD-30L-5](#) [RSD-60G-5](#)
[RSD-60H-24](#) [RSD-60H-3.3](#) [RSD-60H-5](#) [RSD-30G-5](#) [VHK200W-Q24-S12](#) [RSD-60L-5](#) [MGFS32412](#) [VHK150W-Q24-S12](#) [TEQ 300-](#)
[7216WIR](#) [MGFS32415](#) [MGFS3243R3](#) [PS8-250ATX-ZE](#) [RPS8-750ATX-XE](#) [PS8-300ATX-ZBE](#) [RPM40-2412DG](#) [TEQ 300-7215WIR](#)