

# Features

- 4:1 wide input range
- 3kVAC reinforced insulation for 110Vin  
2.25kVDC basic insulation for 24Vin & 48Vin
- Efficiency up to 93%
- No minimum load required
- EN50155, IEC/EN60950-1 & UL60950-1 certified

# Regulated Converter

# RECOM DC/DC Converter

## RP100H-RW

100 Watt  
Half Brick  
Single Output



EN50155 certified  
IEC/EN60950-1 certified  
UL60950-1 certified

## Description

The half-brick RP100H series DC/DC converters are designed for railway rolling stock and high voltage battery applications. Each series has three 4:1 input voltage range options to cover all input voltages from 9VDC up to 160VDC with isolated and regulated 5V to 48VDC outputs. The converters have high efficiencies and metal base-plates to permit a wide operating temperature range from -40°C to +85°C (when mounted on a suitable heatsink). The case is fitted with threaded inserts to allow secure mounting to the PCB or bulkhead for use in high shock and vibration environments. The converters are EN50155, UL60950 and IEC/EN60950 certified. The RP100H-RW series have a three year warranty.

## Selection Guide

Part Number	Input Voltage Range [VDC]	Output Voltage [VDC]	Output Current [mA]	Input <sup>(1)</sup> Current [mA]	Output Power [W]	Efficiency <sup>(1)</sup> typ. [%]	Max. Capacitive Load [µF]
RP100H-2405SRW	9-36	5	20000	4480	100	93	40000
RP100H-2412SRW	9-36	12	8400	4666	101	90	7000
RP100H-2415SRW	9-36	15	6700	4601	100	91	4460
RP100H-2424SRW	9-36	24	4200	4666	101	90	1750
RP100H-2448SRW	9-36	48	2100	4666	101	90	430
RP100H-4805SRW	16.5-75	5	20000	2240	100	93	40000
RP100H-4812SRW	16.5-75	12	8400	2333	101	90	7000
RP100H-4815SRW	16.5-75	15	6700	2300	100	91	4460
RP100H-4824SRW	16.5-75	24	4200	2333	101	90	1750
RP100H-4848SRW	16.5-75	48	2100	2307	101	90	430
RP100H-11005SRW	43-160	5	20000	1010	100	93	40000
RP100H-11012SRW	43-160	12	8400	1018	101	90	7000
RP100H-11015SRW	43-160	15	6700	1015	100	91	4460
RP100H-11024SRW	43-160	24	4200	1018	101	90	1750
RP100H-11048SRW	43-160	48	2100	1007	101	90	430

### Notes:

Note1: Efficiency is tested by nominal Vin, full load and at 25°C

## Model Numbering

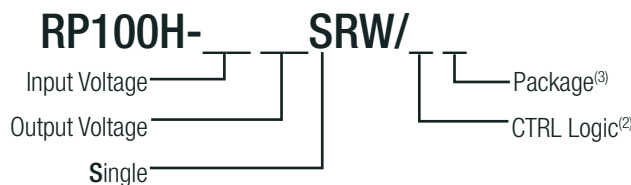

### Ordering Examples

- RP100H-2405SRW/N = 24V Input, 5V Output, Single, Neg. CTRL function
- RP100H-11012SRW/P = 110V Input, 12V Output, Single, Pos. CTRL function
- RP100H-2405SRW/N-HC = 24V Input, 5V Output, Single, Neg. CTRL function, premounted Heat-sink

### Notes:

- Note2: standard part is with suffix "P" for positive logic (1=ON, 0=OFF) or add suffix "N" instead for negative logic (0=ON, 1=OFF)
- Note3: add suffix "-HC" for premounted Heat-sink (compatible with all other suffixes)



[www.recom-power.com/eval-ref-boards](http://www.recom-power.com/eval-ref-boards)



[https://www.recom-power.com/pdf/Powerline\\_DC-DC/RSPxxx-168.pdf](https://www.recom-power.com/pdf/Powerline_DC-DC/RSPxxx-168.pdf)

**Specifications** (measured @Ta = 25°C, resistive load, nominal Vin and rated Iout unless otherwise noted)

### BASIC CHARACTERISTICS

Parameter	Condition	Min.	Typ.	Max.
Internal Input Filter				Pi-Type
Input Voltage Range	nom Vin = 24V nom Vin = 48V nom Vin = 110V	9VDC 16.5VDC 43VDC	24VDC 48VDC 110VDC	36VDC 75VDC 160VDC
Input Surge Voltage	Vin = 24V, 1s max. Vin = 48V, 1s max. Vin = 110V, 1s max.			50VDC 100VDC 185VDC
Quiescent Current	Vin = 24V Vin = 48V Vin = 110V	25mA 15mA	10mA	35mA 25mA
Start-up time	Power up Remote ON/OFF		75ms 75ms	
Internal Operating Frequency	Vin = 24V, Vin = 48V Vin = 110V	225kHz 270kHz	250kHz 300kHz	275kHz 330kHz
Minimum Load		0%		
Ripple and Noise	Measured by 20MHz BW with a 1µF/25V X7R MLCC & a 22µF/25V POS Cap with a 1µF/25V X7R MLCC & a 22µF/25V POS Cap with a 4.7µF/50V X7R MLCC with a 2.2µF/100V X7R MLCC	5 Vout 12, 15Vout 24Vout 48Vout	75mVp-p 100mVp-p 200mVp-p 300mVp-p	
Under Voltage Lockout (UVLO)	Vin = 24V	DC-DC ON DC-DC OFF	7.3VDC	9VDC 8.1VDC
	Vin = 48V	DC-DC ON DC-DC OFF	15.5VDC	18VDC 16.3VDC
	Vin = 110V	DC-DC ON DC-DC OFF	33.0VDC	43VDC 36.0VDC
ON/OFF Control	Positive Logic	DC-DC ON DC-DC OFF		Open or 3.0V < Vr < 12V Short or 0V < Vr < 1.2V
	Negative Logic	DC-DC ON DC-DC OFF		Short or 0V < Vr < 1.2V Open or 3.0V < Vr < 12V
Input current of CTRL pin		-0.5mA		1mA
Standby Current			3mA	
Output Trim		-20%		+10%
Remote Sense	% of nom Vout			10%

RP100H-2405SRW

Efficiency vs. Output Current

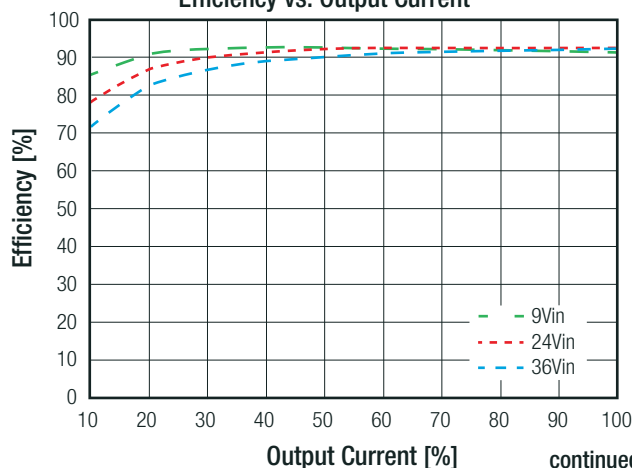

Efficiency vs. Input Voltage

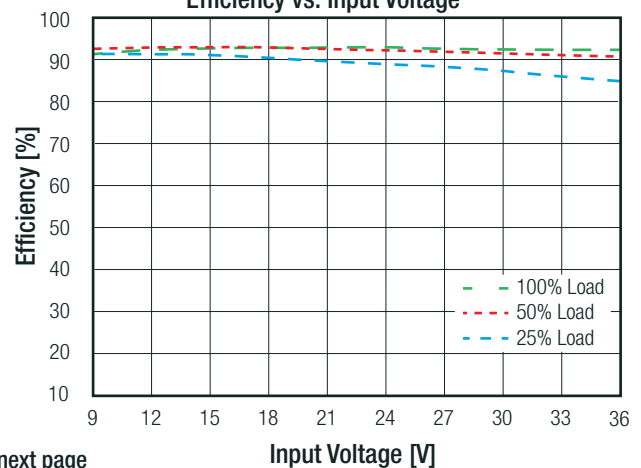

continued on next page

Specifications (measured @Ta = 25°C, resistive load, nominal Vin and rated Iout unless otherwise noted)

RP100H-2405SRW

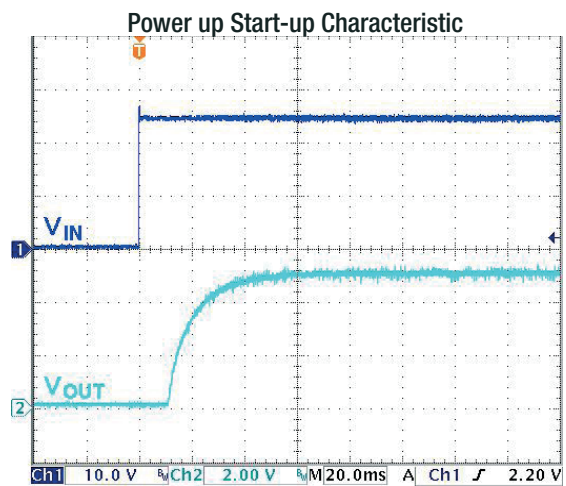
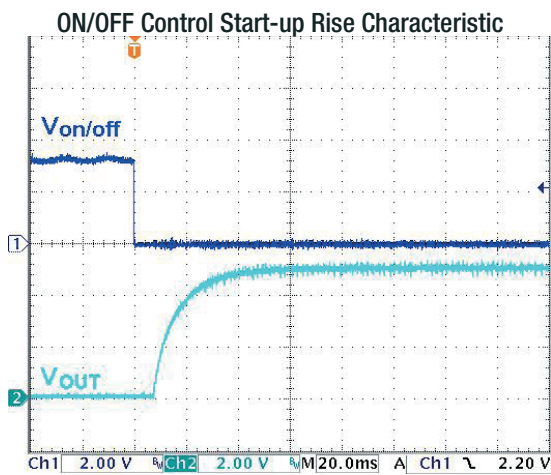
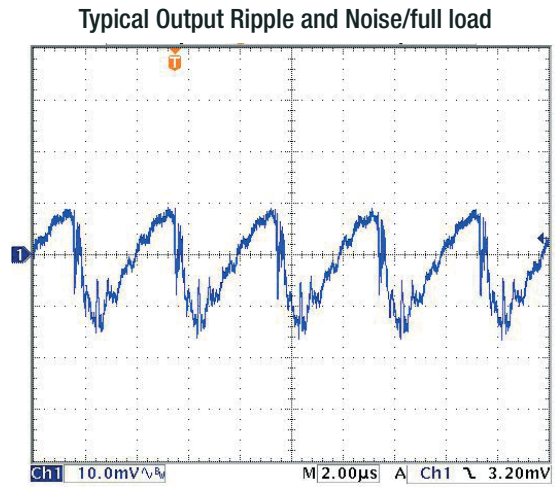
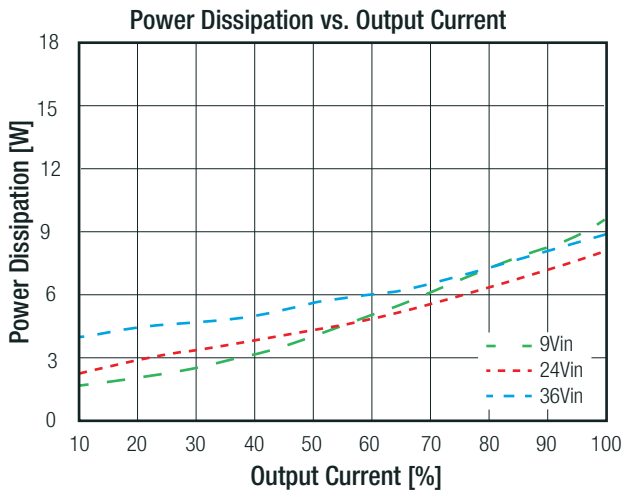

RP100H-4805SRW

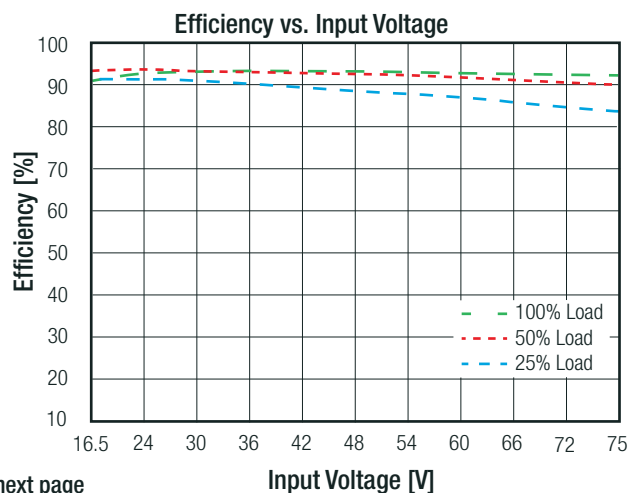
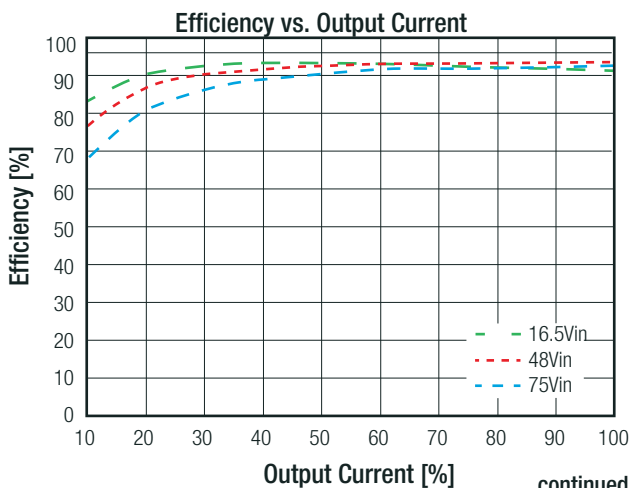

continued on next page

Specifications (measured @Ta = 25°C, resistive load, nominal Vin and rated Iout unless otherwise noted)

### RP100H-4805SRW

Power Dissipation vs. Output Current

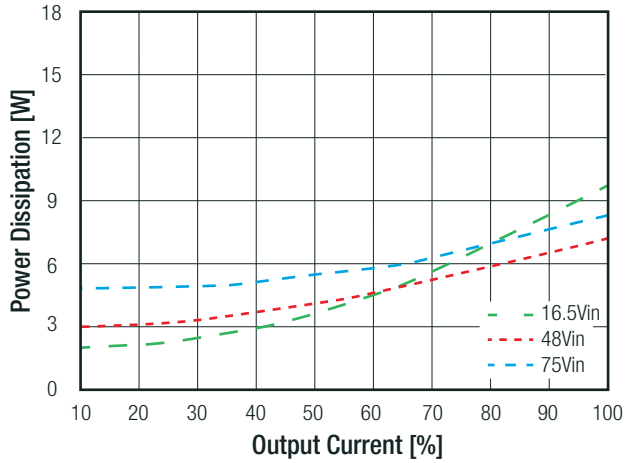

Typical Output Ripple and Noise/full load

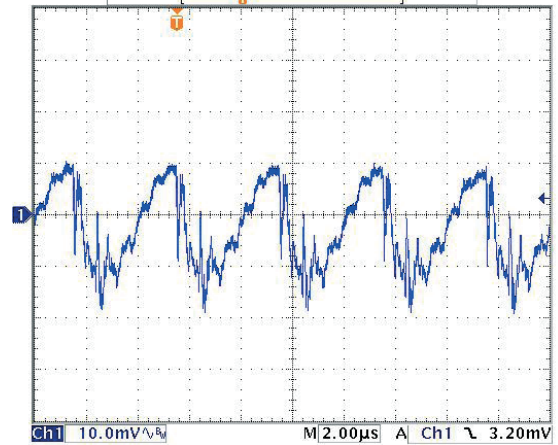

ON/OFF Control Start-up Rise Characteristic

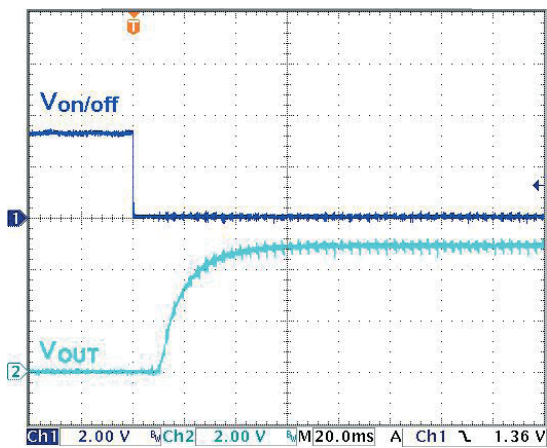

Power up Start-up Characteristic

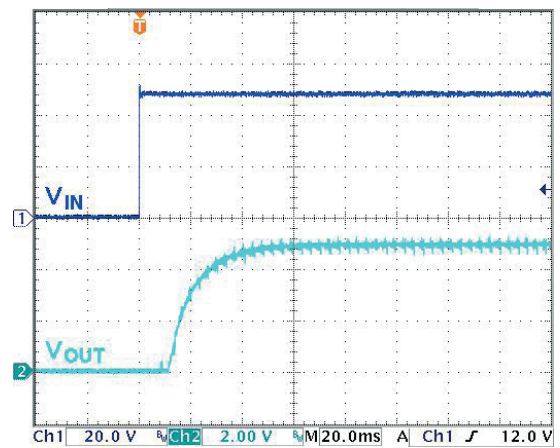

### RP100H-11005SRW

Efficiency vs. Output Current

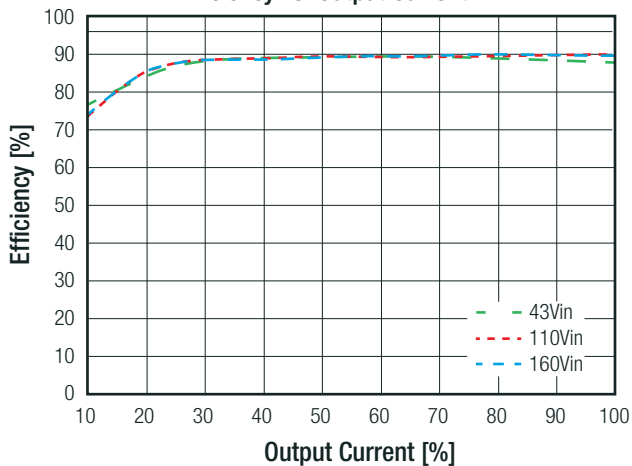

Efficiency vs. Input Voltage

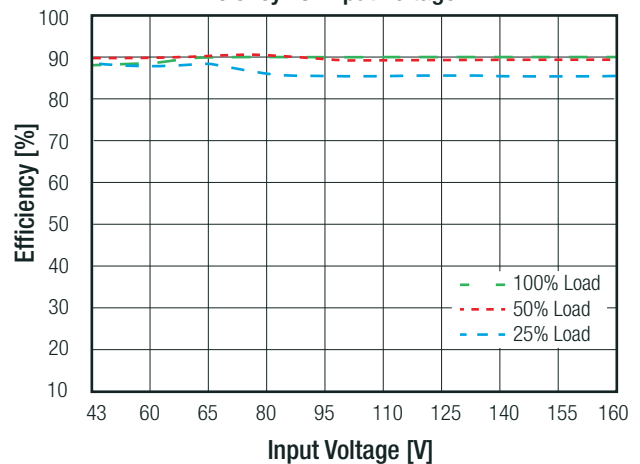

continued on next page

Specifications (measured @Ta = 25°C, resistive load, nominal Vin and rated Iout unless otherwise noted)

### RP100H-11005SRW

Power Dissipation vs. Output Current

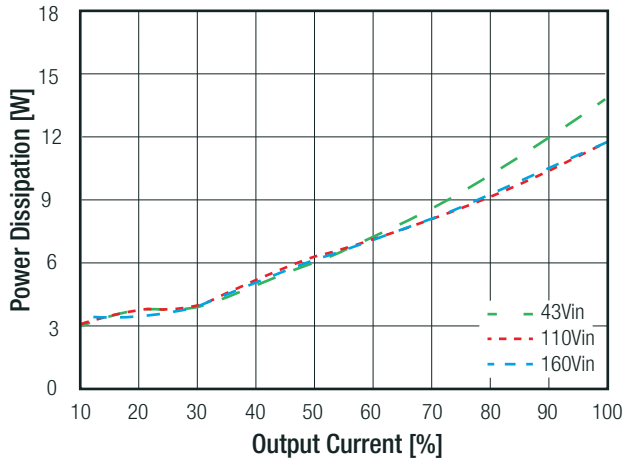

Typical Output Ripple and Noise

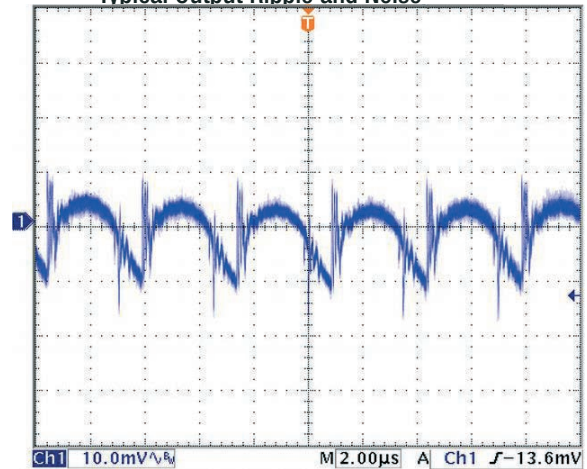

ON/OFF Control Start-up Rise Characteristic

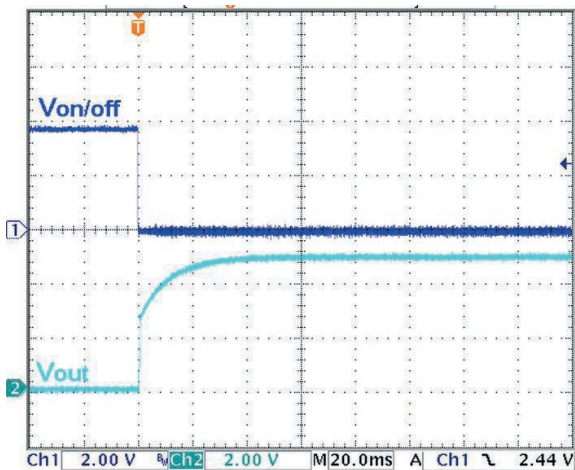

Power up Start-up Characteristic

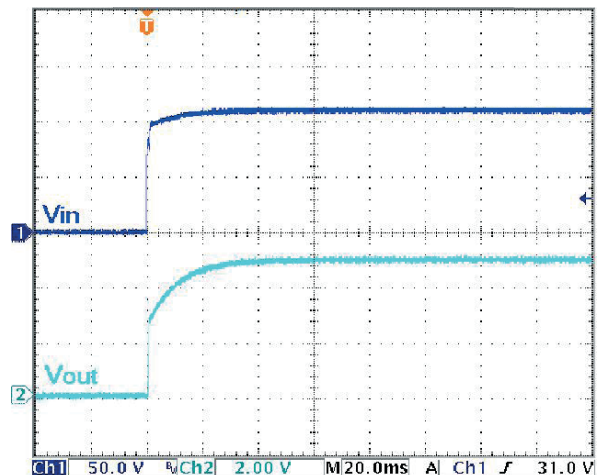

## OUTPUT TRIM

### Output Voltage Trimming

RP100H-RW converters offer the feature of trimming the output voltage over a certain range around the nominal value by using external trim resistors. The values for trim resistors shown in trim tables below are according to standard E96 values; therefore, the specified voltage may slightly vary; they also can be calculated with below shown equation.

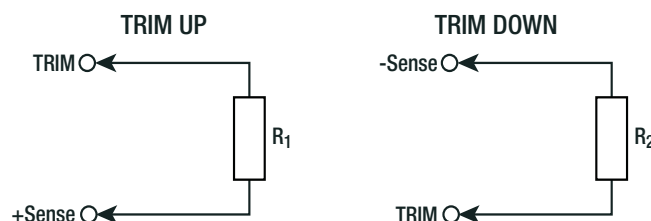

continued on next page



**Specifications** (measured @Ta = 25°C, resistive load, nominal Vin and rated Iout unless otherwise noted)

### OUTPUT TRIM

**Trim Calculation**

$$R_1 = \left[ \frac{100 \cdot V_{out} + \Delta V_{out} \cdot V_{out}}{1.225 \cdot \Delta V_{out}} - \frac{(100 + 2 \Delta V_{out})}{\Delta V_{out}} \right] k\Omega$$

$$R_2 = \left[ \frac{100}{\Delta V_{out}} - 2 \right] k\Omega$$

Vout = Output Voltage  
 ΔVout = Output Voltage Trim in %  
 R1 = trim up resistor  
 R2 = trim down resistor

**Practical Example:**
**Trim Up:**

Vout = 5V, ΔVout = 10% (5.5V)

$$R_1 = \left[ \frac{100 \cdot V_{out} + \Delta V_{out} \cdot V_{out}}{1.225 \cdot \Delta V_{out}} - \frac{(100 + 2 \Delta V_{out})}{\Delta V_{out}} \right] k\Omega = \left[ \frac{100 \cdot 5 + 10 \cdot 5}{1.225 \cdot 10} - \frac{100 + 2 \cdot 10}{10} \right] = 44.89 - 12 = 32.9 k\Omega$$

**Trim down:**

Vout = 5V, ΔVout = -10% (4.5V)

$$R_2 = \left[ \frac{100}{\Delta V_{out}} - 2 \right] k\Omega = \frac{100}{10} - 2 = 8.06 k\Omega$$

**RP100H-xx05SRW**

Trim up	1	2	3	4	5	6	7	8	9	10	%
Vout =	5.05	5.10	5.15	5.20	5.25	5.30	5.35	5.4	5.45	5.50	Volts
R <sub>1</sub> =	309	158	105	78.7	63.4	53.6	46.4	40.2	36.5	33.2	kOhms

**RP100H-xx12SRW**

Trim up	1	2	3	4	5	6	7	8	9	10	%
Vout =	12.12	12.24	12.36	12.48	12.60	12.72	12.84	12.96	13.08	13.20	Volts
R <sub>1</sub> =	887	453	301	226	182	154	133	118	105	95.3	kOhms

**RP100H-xx15SRW**

Trim up	1	2	3	4	5	6	7	8	9	10	%
Vout =	15.15	15.30	15.45	15.60	15.75	15.90	16.05	16.20	16.35	16.50	Volts
R <sub>1</sub> =	1130	576	383	294	237	196	169	150	137	124	kOhms

**RP100H-xx24SRW**

Trim up	1	2	3	4	5	6	7	8	9	10	%
Vout =	24.24	24.48	24.72	24.96	25.20	25.44	25.68	25.92	26.16	26.40	Volts
R <sub>1</sub> =	1870	953	634	487	392	324	280	249	226	205	kOhms

**RP100H-xx48SRW**

Trim up	1	2	3	4	5	6	7	8	9	10	%
Vout =	48.48	48.96	49.44	49.92	50.40	50.88	51.36	51.84	52.32	52.80	Volts
R <sub>1</sub> =	3830	1960	1300	1000	806	681	576	511	464	422	kOhms

**Trim Down all Vout's**

Trim down	1	2	3	4	5	6	7	8	9	10	%
R <sub>2</sub> =	97.6	47.5	31.6	23.2	17.8	14.7	12.1	10.5	9.09	8.06	kOhms
Trim down	11	12	13	14	15	16	17	18	19	20	%
R <sub>2</sub> =	7.15	6.34	5.76	5.11	4.64	4.22	3.92	3.57	3.24	3.01	kOhms

continued on next page

Specifications (measured @Ta = 25°C, resistive load, nominal Vin and rated Iout unless otherwise noted)

**Remote Sense**

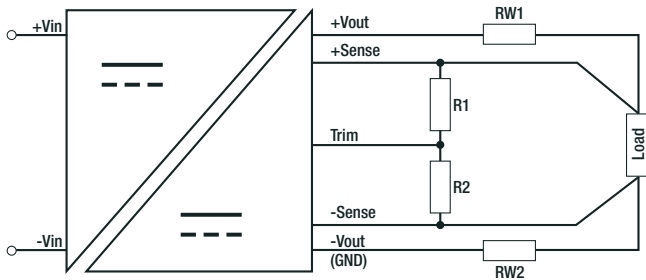

The output voltage can be adjusted by both trim and remote sense. The maximum combined adjustment range  $\pm 10\%$ . Derate the maximum output power if using the trim or sense function.

- R<sub>W1</sub> ... wire losses +
- R<sub>W2</sub> ... wire losses -
- R<sub>1</sub> ... trim up resistor
- R<sub>2</sub> ... trim down resistor

**REGULATIONS**

Parameter	Condition	Value
Output Accuracy		$\pm 1.0\%$
Line Regulation	low line to high line at full load	$\pm 0.1\%$
Load Regulation	0% to 100% load	0.1%
Transient Response	25% load step change	200 $\mu$ s typ.; 250 $\mu$ s max.

**Transient Response to Dynamic Load Change from 100% to 75% to 100% of Full Load at nom.Vin**

RP100H-2405SRW

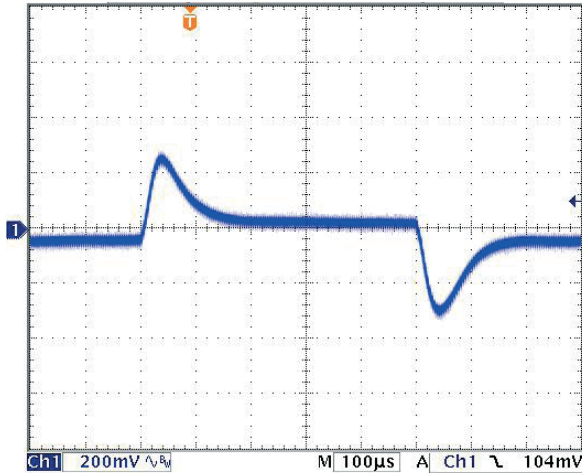

RP100H-4805SRW

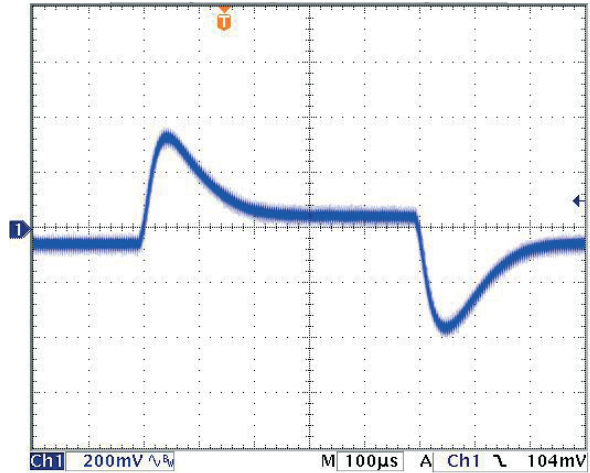

RP100H-11005SRW

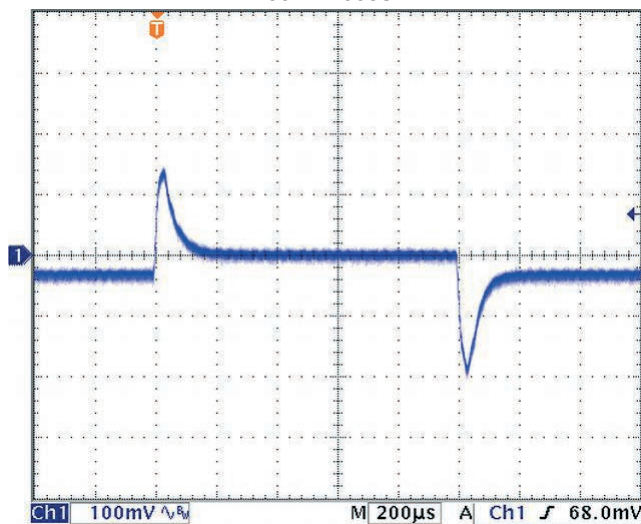

**Specifications** (measured @Ta = 25°C, resistive load, nominal Vin and rated Iout unless otherwise noted)

### PROTECTIONS

Parameter	Condition		Value
Short Circuit Protection (SCP)	below 100mΩ		continuous, automatic recovery
Over Voltage Protection (OVP)	% of nom. Vout		115%-130%, Hiccup Mode
Over Load Protection (OLP)	% Iout rated	24Vin, 48Vin 110Vin	120%-150%, Hiccup Mode 150% typ., Hiccup Mode
Over Temperature Protection (OTP)			+110°C to +120°C
Isolation Voltage	110Vin	I/P to O/P I/P or O/P to Case	3kVAC/1 minute 1.5kVAC/1 minute
	24Vin, 48Vin	I/P to O/P I/P or O/P to Case	2.25kVDC/1 minute 1.6kVDC/1 minute
Isolation Resistance	500 VDC		1GΩ min.
Isolation Capacitance			2500pF max.
Isolation Grade	110 Vin 24Vin, 48Vin		reinforced insulation basic insulation

**Notes:**

Note4: Refer to local wiring regulations if input over-current protection is also required. Recommended fuse: T35A slow blow.

### ENVIRONMENTAL

Parameter	Condition	Value
Operating Case Temperature Range		refer to derating graph
Maximum Case Temperature		105°C
Temperature Coefficient		±0.02%/°C max.
Thermal Impedance	vertical direction by natural convection (0.1m/s) without Heat-sink vertical direction by natural convection (0.1m/s) with Heat-sink	6.7°C/W 4.7°C/W
Operating Humidity		5% - 95% RH
Pollution Degree		PD2
Shock		according to EN61373 standard
Thermal Shock		according to MIL-STD-810F standard
Vibration		according to EN61373 standard
Fire protection on railway vehicles		according to EN45545-2, 2013 standard
MTBF	according to MIL-HDBK-217F standard, 25°C	408.7 x 10 <sup>3</sup> hours

### Thermal Calculation

$$R_{th\text{case-ambient}} = 6.7^\circ\text{C/W (vertical)}$$

$$R_{th\text{case-ambientHC}} = 4.7^\circ\text{C/W (vertical)}$$

$$R_{th\text{case-ambient}} = \frac{T_{\text{case}} - T_{\text{ambient}}}{P_{\text{dissipation}}}$$

$$P_{\text{dissipation}} = P_{\text{IN}} - P_{\text{OUT}} = \frac{P_{\text{OUTapp}}}{\eta} - P_{\text{OUTapp}}$$

- T<sub>case</sub> = Case Temperature
- T<sub>ambient</sub> = Environment Temperature
- P<sub>dissipation</sub> = Internal losses
- P<sub>IN</sub> = Input Power
- P<sub>OUT</sub> = Output Power
- η = Efficiency under given Operating Conditions
- R<sub>thcase-ambient</sub> = Thermal Impedance

### Practical Example:

Take the RP100H-2405SRW with 9V input Voltage and 50% load. What is the maximum ambient operating temperature? Use converter vertical in application without airflow.

$$\text{Eff}_{\text{min}} = 91\% @ V_{\text{nom}}$$

$$P_{\text{OUT}} = 100\text{W}$$

$$P_{\text{OUTapp}} = 100 \times 0.5 = 50\text{W}$$

$$\eta = 91\% \text{ (Efficiency vs. Load Graph)}$$

$$P_{\text{dissipation}} = \frac{50}{0.91} - 50 = 4.95\text{W}$$

#### without Heat-sink

$$R_{th} = \frac{T_{\text{casemax}} - T_{\text{amb}}}{P_{\text{dissipation}}} \rightarrow 6.7^\circ\text{C/W} = \frac{105 - T_{\text{amb}}}{4.95\text{W}}$$

$$T_{\text{amb}} = 72^\circ\text{C}$$

#### with Heat-sink

$$R_{thHC} = \frac{T_{\text{casemax}} - T_{\text{amb}}}{P_{\text{dissipation}}} \rightarrow 4.7^\circ\text{C/W} = \frac{105 - T_{\text{amb}}}{4.95\text{W}}$$

$$T_{\text{ambHC}} = 82^\circ\text{C}$$

continued on next page



Specifications (measured @Ta = 25°C, resistive load, nominal Vin and rated Iout unless otherwise noted)

**Derating Graph<sup>(5)</sup>**

(@ Chamber - tested with forced convection)

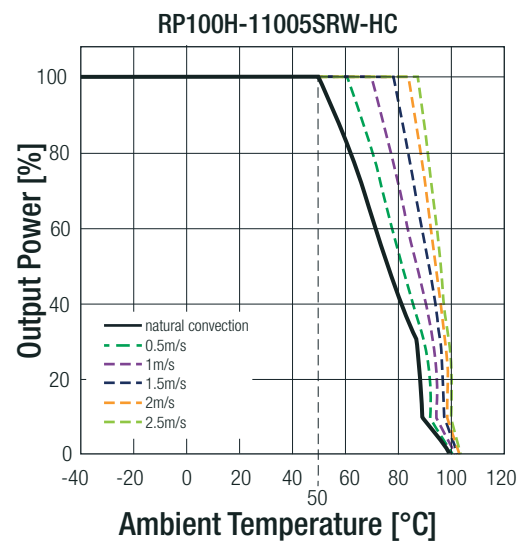
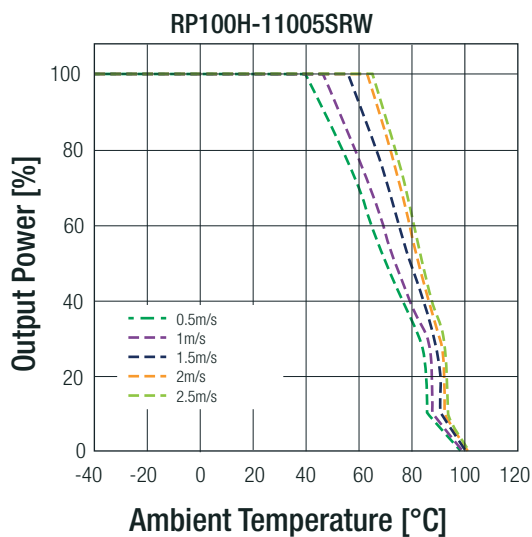
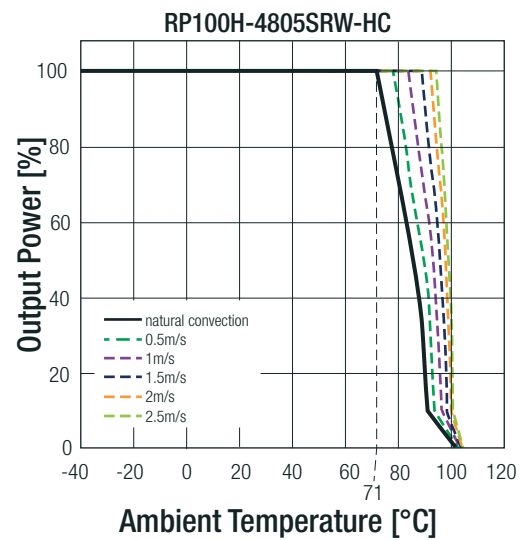
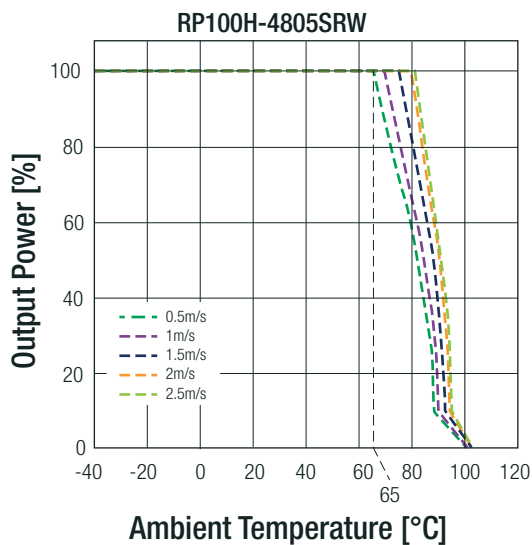
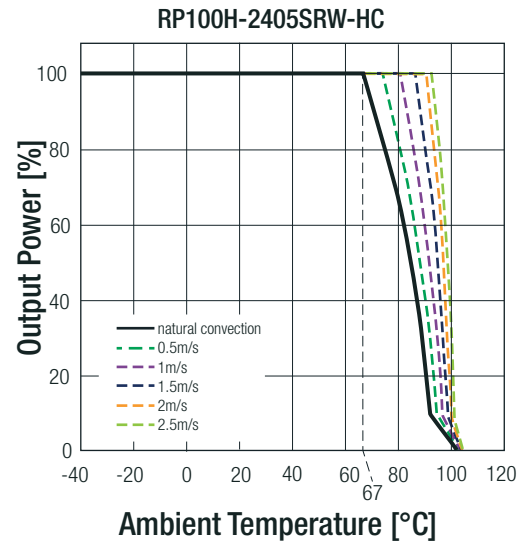
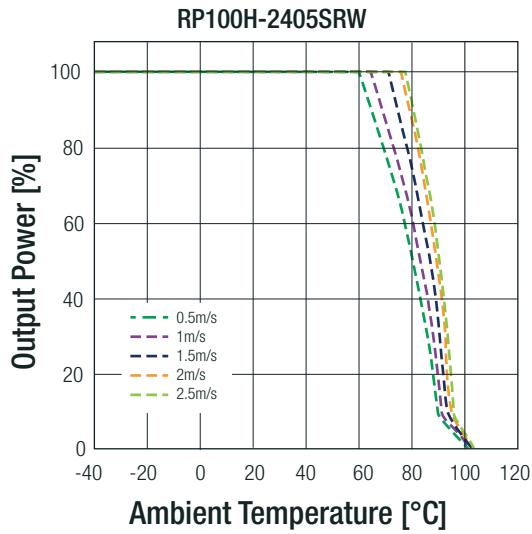

**Notes:**

Note5: Derating graphs are valid only for the shown part numbers. If you need detailed derating-information about a part-number not shown here please contact our technical support service at [techsupportAT@recom-power.com](mailto:techsupportAT@recom-power.com)

**Specifications** (measured @Ta = 25°C, resistive load, nominal Vin and rated Iout unless otherwise noted)

### SAFETY AND CERTIFICATIONS

Certificate Type (Safety)	Report / File Number	Standard
Information Technology Equipment, General Requirements for Safety	E196683	UL60950-1, 2nd Edition, 2014 CSA C22.2 No. 60950-1-07, 2014
IEC/EN Information Technology Equipment - General Requirements for Safety	TW1608033-001, TW1608036-001, TW1608037-001, TW1608079-001	IEC60950-1, 2nd Edition, 2005 EN60950-1, 1st Edition, 2006
Railway Applications - Electrical Equipment used on rolling stock	16A081501E-C	EN50155, 2007
EAC	RU-AT.49.09571	TP TC 004/2011
RoHS 2+		RoHS 2011/65/EU

### EMI Compliance

Condition	Standard / Criterion
Information technology equipment - Radio disturbance characteristics - Limits and methods of measurement	with external components
Industrial, scientific and medical equipment - Radio frequency disturbance characteristics - Limits and methods of measurement	
ESD Electrostatic discharge immunity test	EN55022, Class A and Class B
Radiated, radio-frequency, electromagnetic field immunity test	EN55011, Class A and Class B
Fast Transient and Burst Immunity <sup>(6)</sup>	Air ±8kV and Contact ±6kV
Surge Immunity <sup>(6)</sup>	20 V/m
Immunity to conducted disturbances, induced by radio-frequency fields	±2kV
Power Magnetic Field Immunity	EN55024 & EN50155 ±2kV
	10 Vr.m.s
	100A/m continuous; 1000A/m 1s
	EN61000-4-2, Criteria A
	EN61000-4-3, Criteria A
	EN61000-4-4, Criteria A
	EN61000-4-5, Criteria A
	EN61000-4-6, Criteria A
	EN61000-4-8, Criteria A

#### Notes:

Note6: An external input filter capacitor is required if the module has to meet EN61000-4-4 and EN61000-4-5.

The **24Vin** and **48Vin** version recommend 2pcs of aluminium electrolytic capacitor to connect in parallel.  
Recom suggest: Nippon Chemi-con KY series, 220µF/100V.

The **110Vin** version recommend 2pcs of aluminium electrolytic capacitor to connect in parallel.  
Recom suggest: Nippon Chemi-con KXJ series, 150µF/200V

### EMI Filtering according to EN55022/11 Class A and EN50121-1 (24Vin and 48Vin)

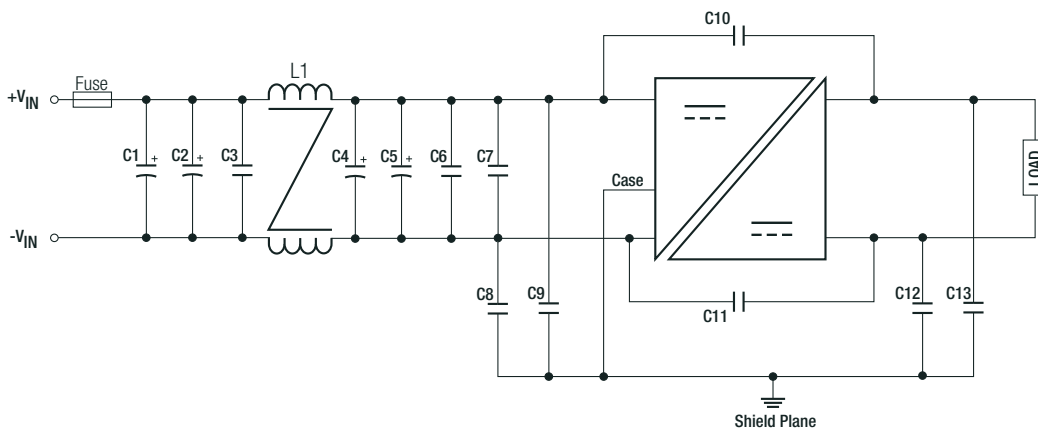

MODEL	C1, C2, C4	C3, C6, C7	C8, C9, C10, C11, C13	C12	L1
RP100H-24xxSRW	470µF, 50V Al cap. (lie down) Chemi-con KY	4.7µF, 50V 1812 MLCC	1000pF, 3kV 1808 MLCC	3300pF, 3kV 1808 MLCC	156µH CMC
RP100H-48xxSRW	220µF, 100V Al cap. (lie down) Chemi-con KY	2.2µF, 100V 1812 MLCC	1000pF, 3kV 1808 MLCC	1000pF, 3kV 1808 MLCC	224µH CMC

continued on next page

Specifications (measured @Ta = 25°C, resistive load, nominal Vin and rated Iout unless otherwise noted)

RP100H-2405SRW

Conducted Emission EN55022 Class A

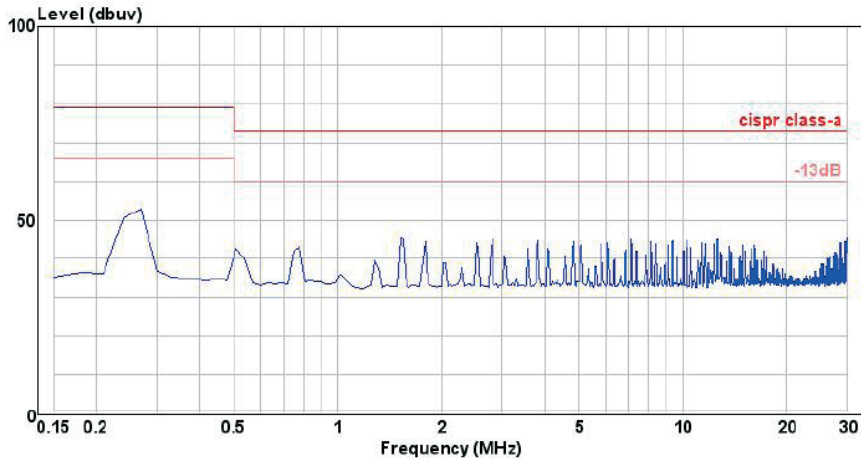

RP100H-4805SRW

Conducted Emission EN55022 Class A

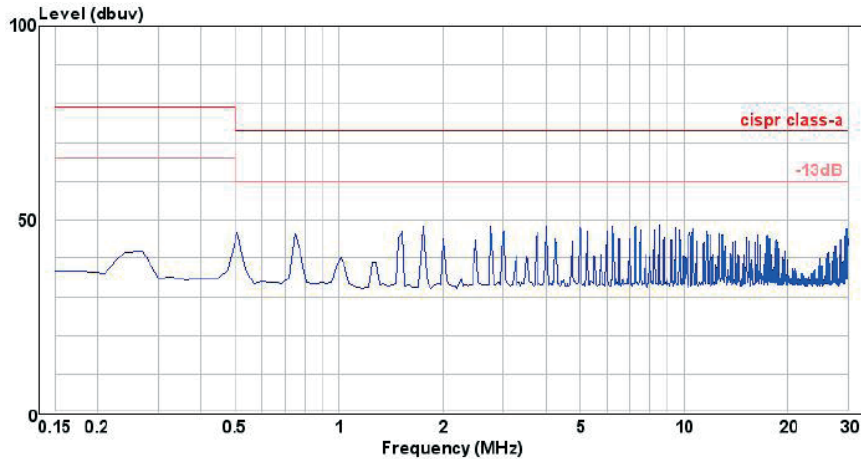

EMI Filtering according to EN55022/11 Class A and EN50121-1 (110Vin)

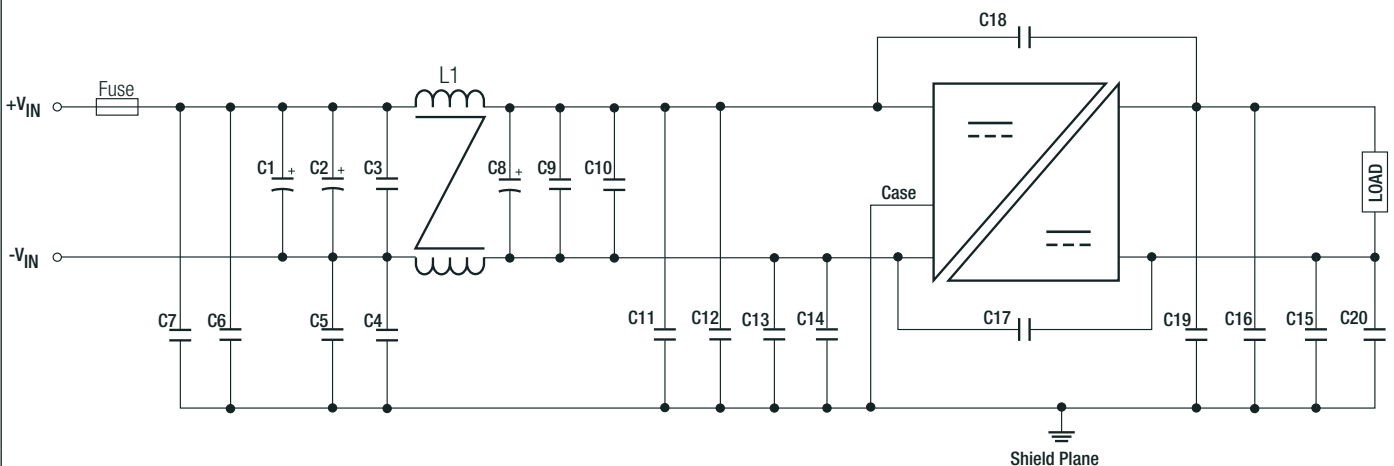

MODEL	C1, C2, C8	C10	C6, C11, C12, C13, C14, C15, C16, C19, C20	C17, C18	L1
RP100H-110xxSRW	100µF, 250V Al cap. (lie down) Rubycon BXF	1µF, 250V 1812 MLCC	1000pF, 5kV 1808 MLCC	2200pF TDK CD series Y1	1219µH CMC

continued on next page

Specifications (measured @Ta = 25°C, resistive load, nominal Vin and rated Iout unless otherwise noted)

RP100H-11005SRW

Conducted Emission EN55022 Class A

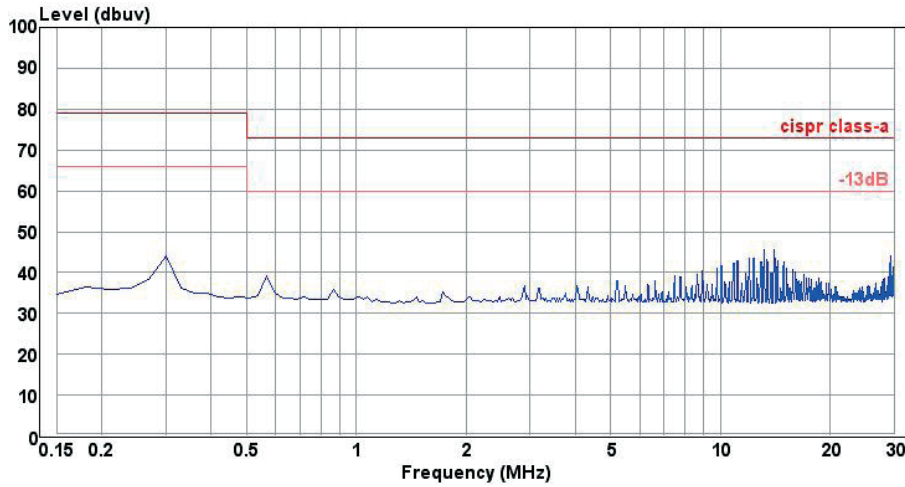

EMI Filtering according to EN55022/11 Class B (24Vin and 48Vin)

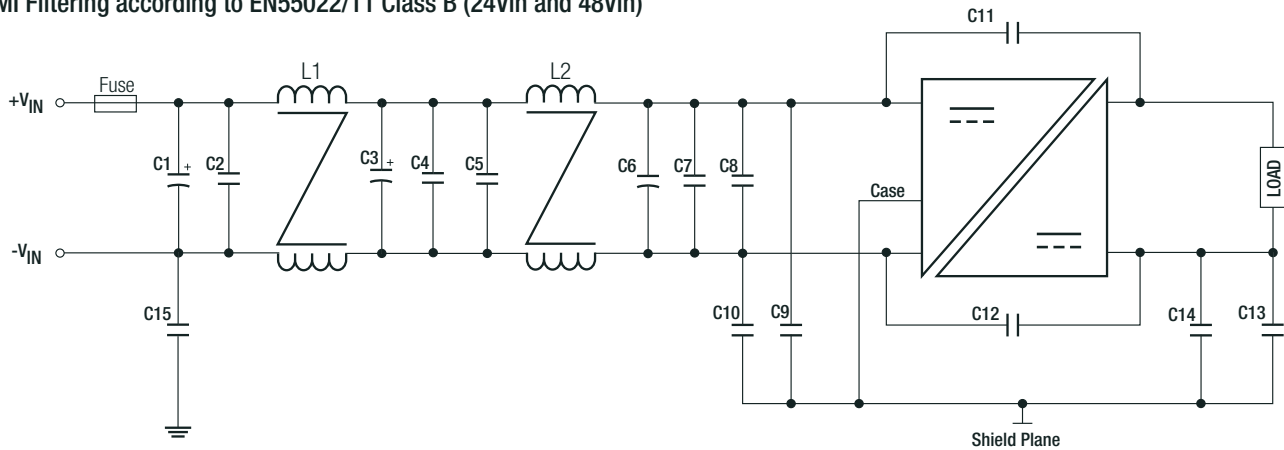

MODEL	C1, C3, C6	C2, C4, C5, C7, C8	C9, C10	C11	C12	C13, C14	C15	L1
RP100H-24xxSRW	470 $\mu$ F, 50V Al cap. (lie down) Chemi-con KY	4.7 $\mu$ F, 50V 1812 MLCC	10nF, 2kV 1812 MLCC	1000pF, 3kV 1808 MLCC	4700pF, 3kV 1812 MLCC	10nF, 2kV 1812 MLCC	N/A	156 $\mu$ H CMC
RP100H-48xxSRW	220 $\mu$ F, 100V Al cap. (lie down) Chemi-con KY	2.2 $\mu$ F, 100V 1812 MLCC	10nF, 100V 1812 MLCC	2200pF, 3kV 1808 MLCC	4700pF, 3kV 1812 MLCC	10nF, 2kV 1812 MLCC	1000pF, 3kV 1808 MLCC	224 $\mu$ H CMC

RP100H-2405SRW

Conducted Emission EN55022 Class B

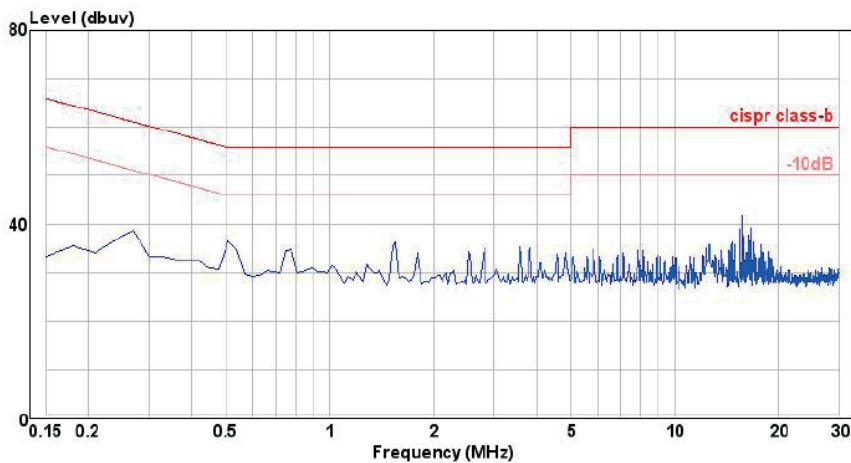

continued on next page

Specifications (measured @Ta = 25°C, resistive load, nominal Vin and rated Iout unless otherwise noted)

### RP100H-4805SRW

#### Conducted Emission EN55022 Class B

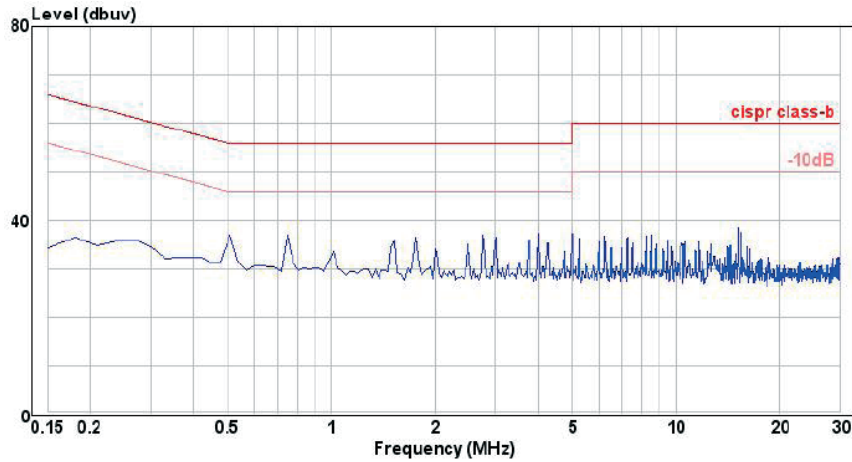

#### EMI Filtering according to EN55022/11 Class B (110Vin)

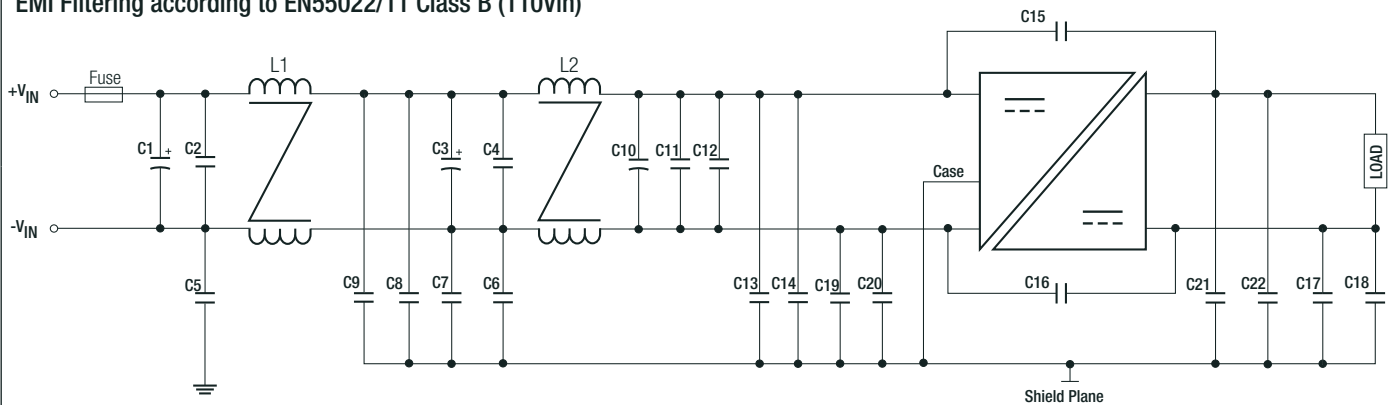

MODEL	C1, C3, C10	C2, C5, C23, C24	C4, C11, C12	C6, C7, C8, C9, C13, C14, C17, C18, C19, C20, C21, C22	C15, C16	L1	L2
RP100H-110xxSRW	150µF, 200V Al cap. (lie down) Chemi-con KY	N/A	1µF, 250V 1812 MLCC	1000pF, 5kV 1808 MLCC	2200pF TDK CD series Y1	1219µH CMC	521µH CMC
RP100H-11048SRW		C2, C4, C11, C12	C5, C6, C7, C19	C8, C9, C13, C14, C17, C18, C19, C20, C21, C22, C23, C24			
		1µF/250V 1812 MLCC	N/A	100pF/250VAC 1808 MLCC			

### RP100H-11005SRW

#### Conducted Emission EN55022 Class B

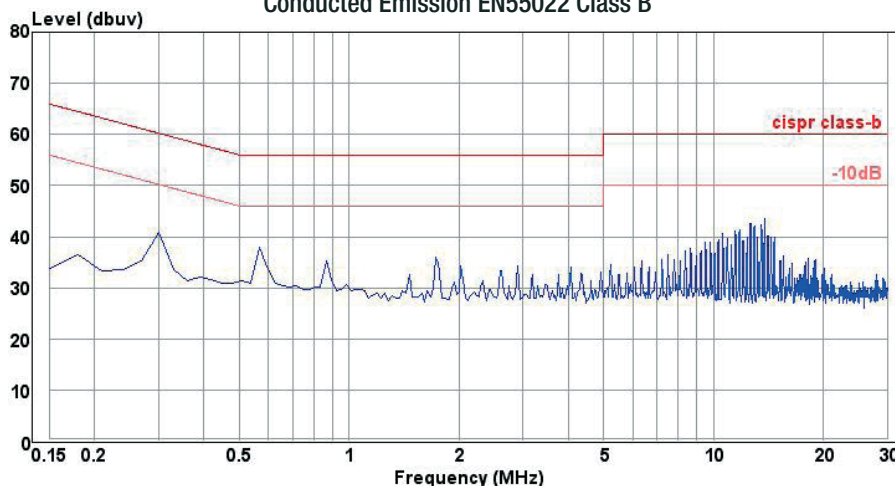



**Specifications** (measured @Ta = 25°C, resistive load, nominal Vin and rated Iout unless otherwise noted)

### DIMENSIONS and PHYSICAL CHARACTERISTICS

Parameter	Type		Value
Material	case	24Vin, 48Vin	Metal
		110Vin	Plastic
	baseplate	24Vin, 48Vin	FR4 PCB
		110Vin	Aluminium
	potting		Silicone (UL94 V-0)
Packaging Dimension (LxWxH)	without Heat-sink		61.0 x 57.9 x 12.7mm
	with Heat-sink		61.0 x 57.9 x 24.13mm
Packaging Weight	without Heat-sink		105g
	with Heat-sink		157g

#### Dimension Drawing (mm)

24Vin, 48Vin

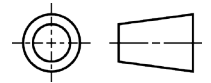
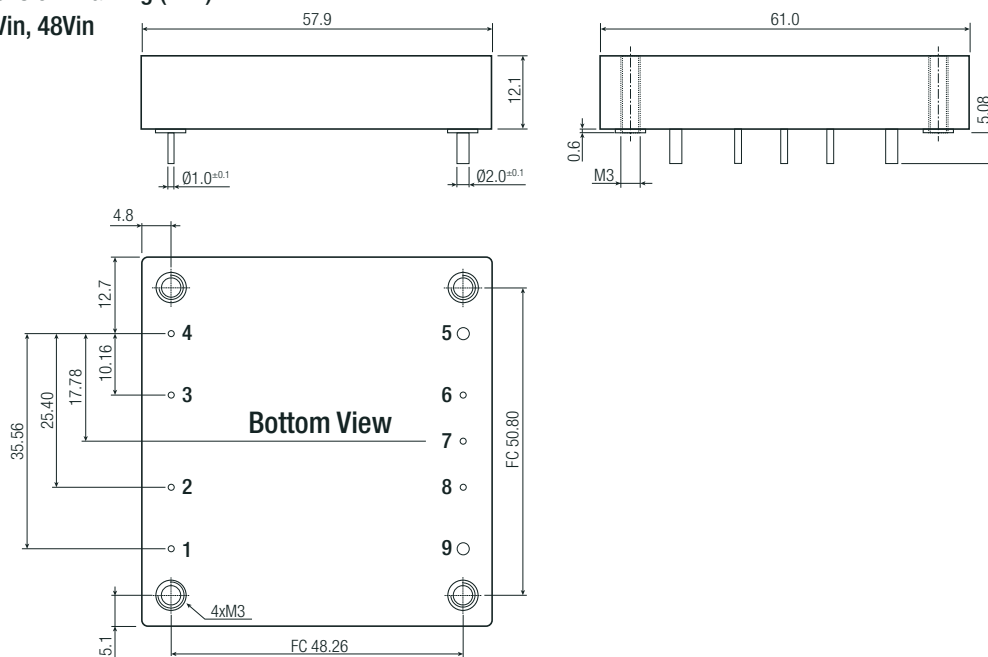

110Vin

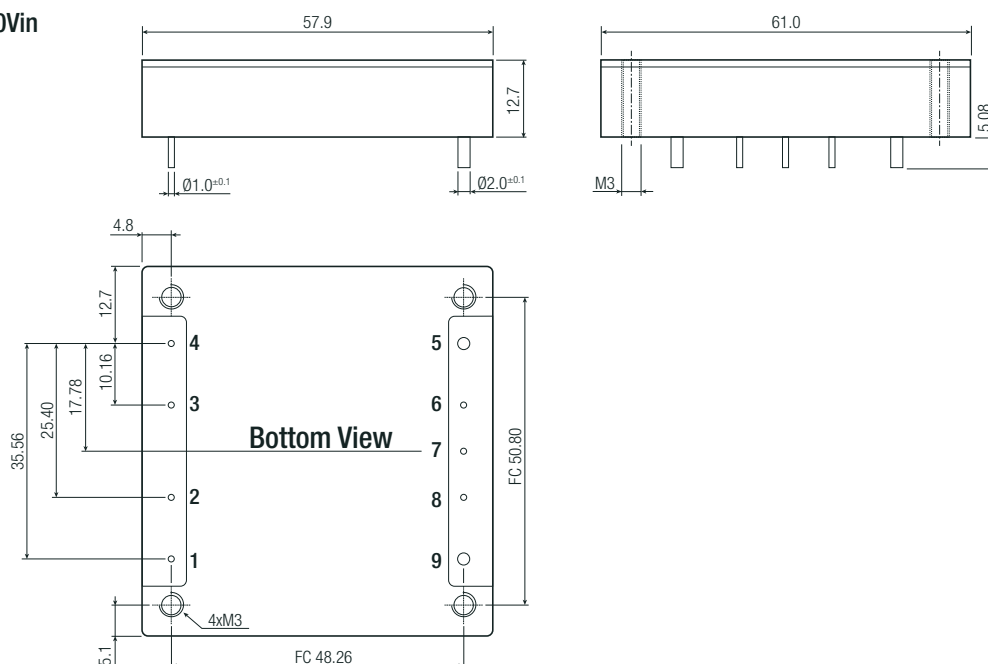

#### Pin Connections

Pin #	Single
1	+Vin
2	CTRL
3	Case
4	-Vin
5	-Vout
6	-Sense
7	Trim
8	+Sense
9	+Vout

FC= Fixing Centers for Heat-sink  
 Pin Pitch Tolerance ±0.25mm  
 Pin Dimension Tolerance ±0.1mm  
 XX.X ± 0.5mm  
 XX.XX ± 0.25mm

continued on next page

**Specifications** (measured @Ta = 25°C, resistive load, nominal Vin and rated Iout unless otherwise noted)

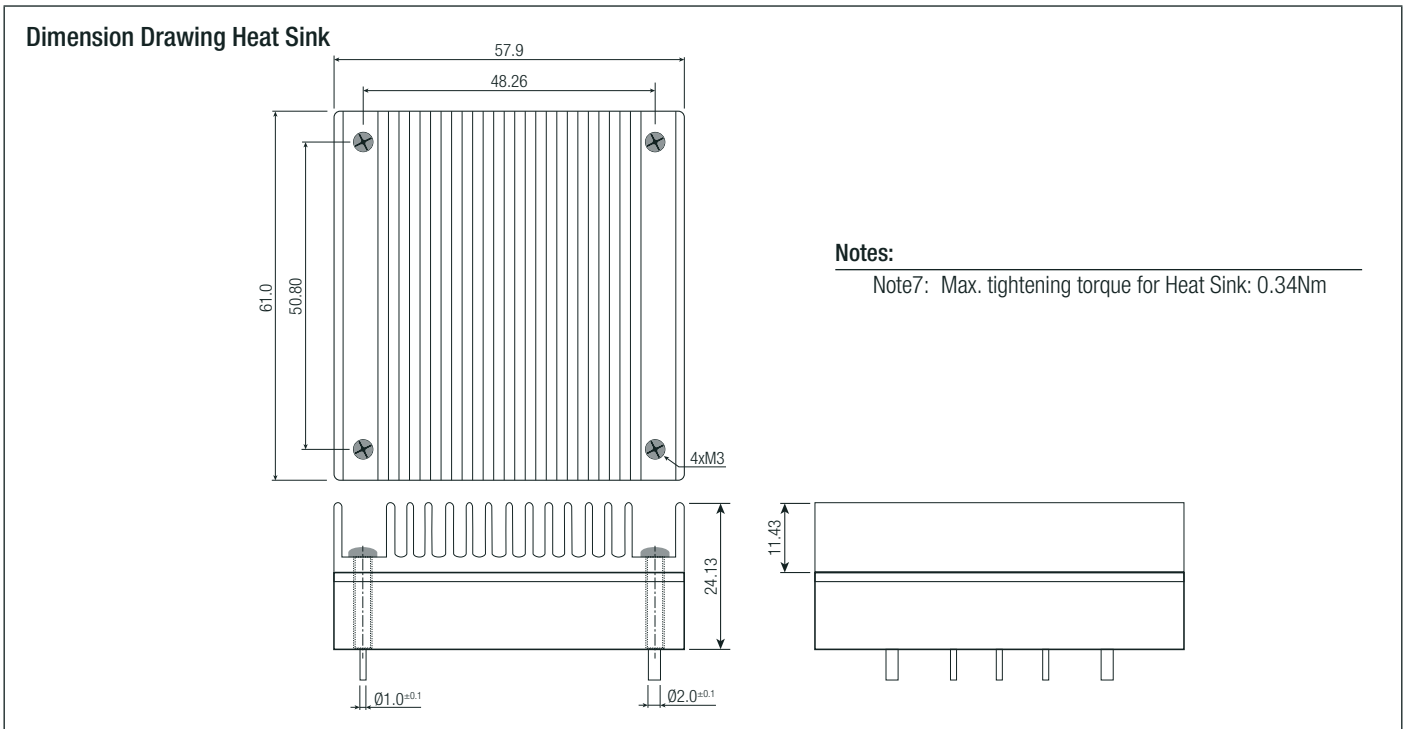

**PACKAGING INFORMATION**

Parameter	Type		Value
	Packaging Dimension	tray	
Packaging Quantity			2pcs.
Storage Temperature Range			-55°C to +125°C
Storage Humidity			5% - 95% RH

The product information and specifications may be subject to changes even without prior written notice. The product has been designed for various applications; its suitability lies in the responsibility of each customer. The products are not authorized for use in safety-critical applications without RECOM's explicit written consent. A safety-critical application is an application where a failure may reasonably be expected to endanger or cause loss of life, inflict bodily harm or damage property. The applicant shall indemnify and hold harmless RECOM, its affiliated companies and its representatives against any damage claims in connection with the unauthorized use of RECOM products in such safety-critical applications.

## X-ON Electronics

Largest Supplier of Electrical and Electronic Components

*Click to view similar products for [Isolated DC/DC Converters](#) category:*

*Click to view products by [Recom Power](#) manufacturer:*

Other Similar products are found below :

[ESM6D044440C05AAQ](#) [FMD15.24G](#) [PSL486-7LR](#) [PSR152.5-7IR](#) [Q48T30020-NBB0](#) [AVO240-48S12B-6L](#) [AVO250-48S28B-6L](#) [NAN-0505](#) [HW-L16D](#) [JAHW100Y1](#) [217-1617-001](#) [22827](#) [SPB05C-12](#) [SQ24S15033-PS0S](#) [18952](#) [19-130041](#) [CE-1003](#) [CE-1004](#) [GQ2541-7R](#) [PSE1000DCDC-12V](#) [RDS180245](#) [MAU228](#) [419-2065-201](#) [449-2075-101](#) [J80-0041NL](#) [V300C24C150BG](#) [419-2062-200](#) [419-2063-401](#) [419-2067-101](#) [419-2067-501](#) [419-2068-001](#) [DCG40-5G](#) [DFC15U48D15](#) [449-2067-000](#) [XGS-0512](#) [XGS-1205](#) [XGS-1212](#) [XGS-2412](#) [XGS-2415](#) [XKS-1215](#) [033456](#) [NCT1000N040R050B](#) [SPB05B-15](#) [SPB05C-15](#) [SSQE48T25025-NAA0G](#) [L-DA20](#) [HP3040-9RG](#) [HP1001-9RTG](#) [NVD0.4YJJ-M6G](#) [XKS-2415](#)