

Features

- 10:1 ultra wide input voltage range
- 4.242kVDC/1 minute reinforced insulation
- UL/IEC/EN60950-1 certified
- CE marked, CB report
- Efficiency up to 93%
- -40°C to +100°C baseplate temperature range

Regulated Converter

RECOM DC/DC Converter

RPA100H-RUW

**100 Watt
Half Brick
Single Output**



UL60950-1 certified
CAN/CSA No. 60950-1-07 certified
IEC/EN60950-1 certified
EN50155 compliant
CB report

Description

The half-brick RPA100H series DC/DC converter is designed for railway rolling stock and high voltage battery applications. It has a 10:1 input voltage range to cover all input voltages from nominal 24VDC up to 110VDC in a single product (including EN50155 transients) and offers isolated and regulated 12V, 15V, 24V or 48VDC outputs. The converter has a consistently high efficiency over the entire input voltage range and comes with a metal baseplate to permit a wide operating temperature range from -40°C to +97°C (when baseplate cooled). The case is fitted with threaded inserts to allow secure mounting to the PCB or bulkhead for use in high shock and vibration environments. The converter is certified to UL/IEC/EN60950 and comes with a three year warranty.

Selection Guide

Part Number	Input Voltage Range ⁽¹⁾ [VDC]	Output Voltage [VDC]	Output Current [A]	Efficiency typ. ⁽²⁾ [%]	Max. Capacitive Load ⁽³⁾ [µF]
RPA100H-11012SRUW ⁽⁴⁾	16.5-140	12	8.5	90	2200
RPA100H-11015SRUW ⁽⁴⁾	16.5-140	15	6.7	93	2200
RPA100H-11024SRUW ⁽⁴⁾	16.5-140	24	4.2	88	1000
RPA100H-11048SRUW ⁽⁴⁾	16.5-140	48	2.1	90	100

Notes:

Note1: Refer to "Input Voltage Range"

Note2: Efficiency is tested at nominal input (110V) and full load at +25°C ambient

Note3: Max. Cap Load is tested at nominal input and full resistive load

Model Numbering

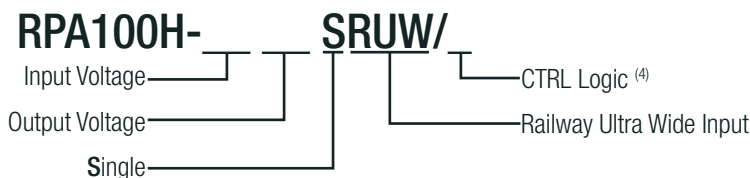

Ordering Examples

RPA100H-11012SRUW/P = 110V Input, 12V Output, Single, Pos. CTRL function

RPA100H-11012SRUW/N = 110V Input, 12V Output, Single, Neg. CTRL function

Notes:

Note4: add suffix "P" for positive logic (1=ON, 0=OFF) or add

suffix "N" instead for negative logic (0=ON, 1=OFF)

Specifications (measured @ Ta = 25°C, nom. Vin (110V), full load and after warm-up unless otherwise stated)

BASIC CHARACTERISTICS					
Parameter	Condition	Min.	Typ.	Max.	
Internal Input Filter					Pi-Type
Input Voltage Range		16.5VDC	110VDC	140VDC	
Input Surge Voltage	<1s			156VDC	
Under Voltage Lockout (UVLO) ⁽⁵⁾	DC-DC ON	15.6VDC	16.0VDC	16.4VDC	
	DC-DC OFF	13.6VDC	14.0VDC	14.4VDC	
Over Voltage Lockout (OVLO)	DC-DC ON	142VDC	146VDC	150VDC	
	DC-DC OFF	154VDC	156VDC	160VDC	
Input Current Range	Vin = 16.5VDC	7A	7.2A	7.5A	
Notes: Note5: Refer to "UNDER VOLTAGE LOCKOUT ADJUSTABILITY" for detail information continued on next page					



https://www.recom-power.com/pdf/Powerline_DC-DC/RSPxxx-168.pdf

Specifications (measured @ Ta = 25°C, nom. Vin (110V), full load and after warm-up unless otherwise stated)

BASIC CHARACTERISTICS

Parameter	Condition		Min.	Typ.	Max.
Quiescent Current	Vin = 110VDC	12, 15, 24Vout 48Vout	30mA 50mA	60mA 80mA	90mA 150mA
Output Voltage Trimming	refer to "OUTPUT VOLTAGE TRIMMING"		-20%		+10%
Minimum Load			0%		
Start-up Time			200ms		460ms
Rise Time	Vout from 10% to 90%			50ms	100ms
ON/OFF Control ⁽⁶⁾	Positive Logic	DC-DC ON DC-DC OFF	Open or $3 < V_r < 5VDC$ Short or $0 < V_r < 0.4VDC$		
	Negative Logic	DC-DC ON DC-DC OFF	Short or $0 < V_r < 0.4VDC$ Open or $3 < V_r < 5VDC$		
Input Current of CTRL pin	DC-DC ON DC-DC OFF			0.1mA 0.1mA	0.2mA 0.1mA
Standby Current				20mA	
Internal Operating Frequency				140kHz	
Output Ripple & Noise	20MHz BW limited			250mVp-p	
Remote Sense ⁽⁶⁾					±10%

Notes:

Note6: For detail information refer to "ON/OFF CONTROL" or "REMOTE SENSE"

RPA100H-11012SRUW

Efficiency vs. Output Current

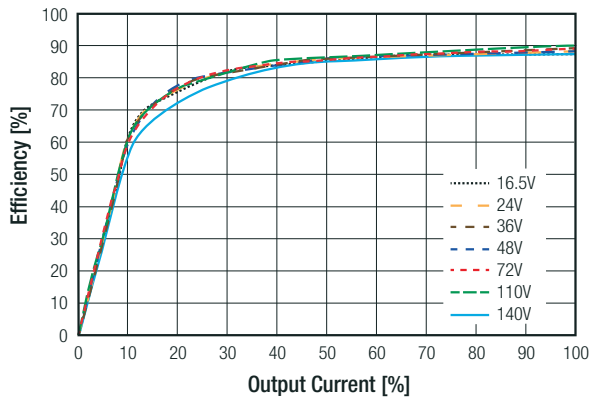

Power Dissipation vs. Output Current

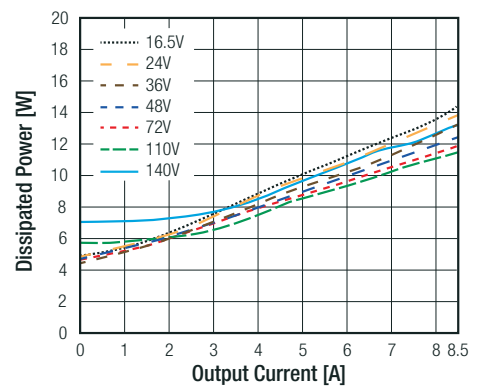

RPA100H-11015SRUW

Efficiency vs. Output Current

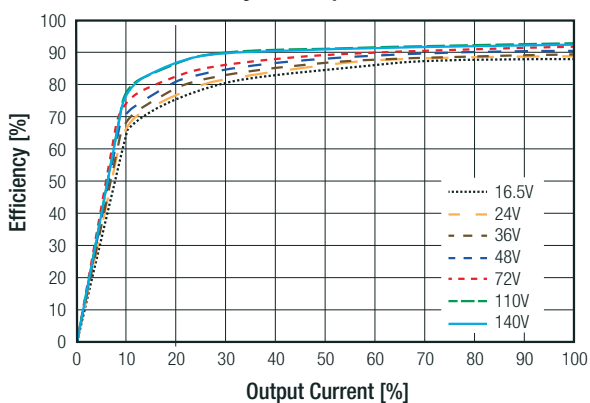

Power Dissipation vs. Output Current

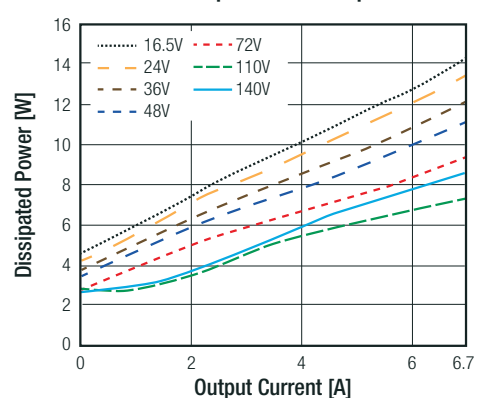

continued on next page

Specifications (measured @ Ta = 25°C, nom. Vin (110V), full load and after warm-up unless otherwise stated)

RPA100H-11024SRUW

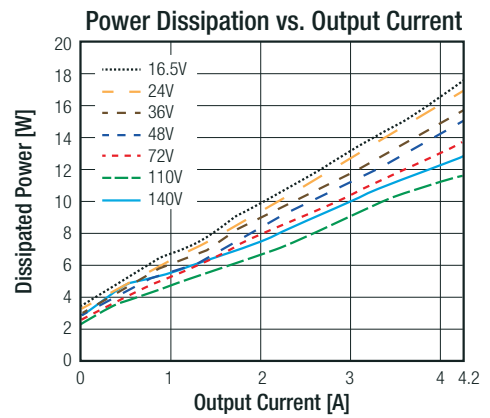
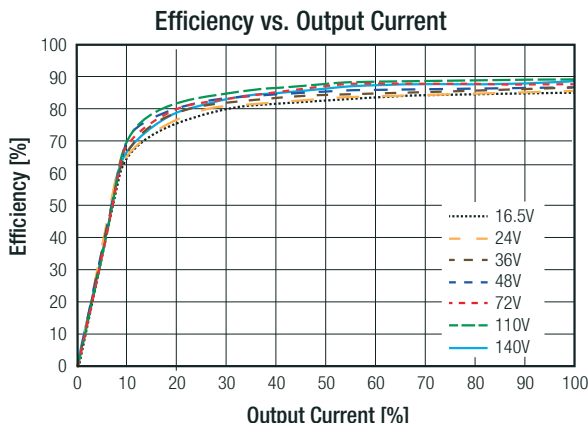

RPA100H-11048SRUW

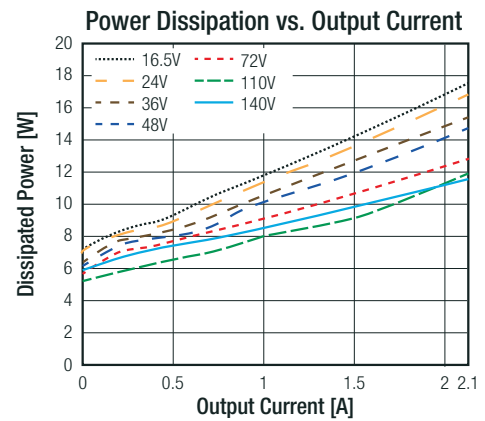
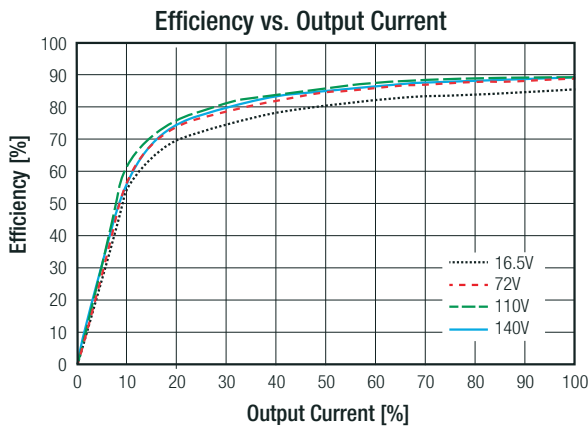

Input Voltage Range

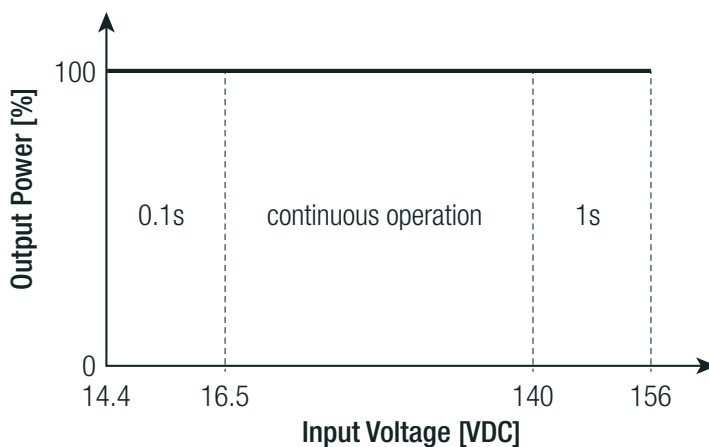

Continuous full power operation is rated between 16.5V and 140V, including full load start-up.

Once running, the converter will operate for short periods of time over an extended input voltage range down to 14.4V and up to 156V, thus covering all EN50155 under-voltage and over-voltage transient conditions.

UNDER VOLTAGE LOCKOUT ADJUSTABILITY

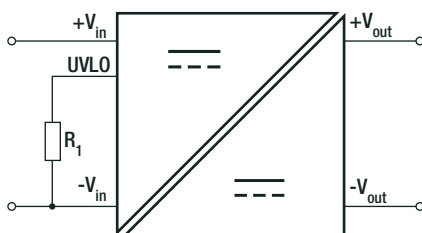

The RPA100H series has an adjustable under voltage lockout which will shut down the converter according to following settings.

Nom. Input Voltage [VDC]	24	36	48	72	110
Turn Off Threshold [VDC]	14±0.4V	21±0.5V	28.5±0.5V	43±1V	65.5±2V
Turn On Threshold [VDC]	16±0.4V	24.5±0.5V	33.5±0.5V	50.5±1V	77±2V
Resistor R1 [kΩ]	open	24.9	12.4	6.19	3.48

Specifications (measured @ Ta = 25°C, nom. Vin (110V), full load and after warm-up unless otherwise stated)

OUTPUT VOLTAGE TRIMMING

Output Voltage Trimming

RPA100H-RUW converters offer the feature of trimming the output voltage over a certain range around the nominal value by using external trim resistors. The values for trim resistors shown in trim tables below are according to standard E96 values; therefore, the specified voltage may slightly vary; they also can be calculated with below shown equation.

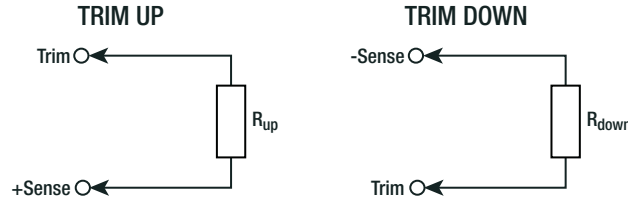

V_{out_nom} = nominal output voltage [VDC]
 ΔV_{out} = output voltage change [%]
 V_{ref} = reference voltage [VDC]
 R_{up} = trim up resistor [Ω]
 R_{down} = trim down resistor [Ω]
 $R_1 - R_3$ = internal resistors [Ω]

V_{out_nom}	R_1	R_2	R_3	V_{ref}
12VDC	10k2 Ω	45k Ω	40k Ω	5.11VDC
15VDC		57k4 Ω	52k3 Ω	
24VDC		95k Ω	90k Ω	
48VDC		195k Ω	190k Ω	

Calculation:

$$R_{up} = \left[\frac{R_2}{\Delta V_{out}} \right] - R_3$$

$$R_{down} = \left[\frac{V_{ref}}{\Delta V_{out}} \right] - R_1$$

Practical Example RPA100H-12SRUW trim up +10%

$$R_{up} = \left[\frac{45k}{0.1} \right] + 40k = 490k\Omega$$

$$R_{up} \text{ according to E96} \approx \underline{487k\Omega}$$

Practical Example RPA100H-12SRUW trim down -8%

$$R_{down} = \left[\frac{5.11}{0.08} \right] - 10k2 = 53k6\Omega$$

$$R_{down} \text{ according to E96} \approx \underline{53k6\Omega}$$

RPA100H-11012SRUW

Trim up	1	2	3	4	5	6	7	8	9	10	[%]
$V_{out_set} =$	12.12	12.24	12.36	12.48	12.60	12.72	12.84	12.96	13.08	13.20	[VDC]
$R_{up} (E96) \approx$	4M53	2M32	1M54	1M15	931k	787k	681k	604	536k	487k	[Ω]

RPA100H-11015SRUW

Trim up	1	2	3	4	5	6	7	8	9	10	[%]
$V_{out_set} =$	15.15	15.30	15.45	15.60	15.75	15.90	16.05	16.20	16.35	16.50	[VDC]
$R_{up} (E96) \approx$	5M76	2M94	1M96	1M50	1M21	1M01	866k	768k	681k	619k	[Ω]

RPA100H-11024SRUW

Trim up	1	2	3	4	5	6	7	8	9	10	[%]
$V_{out_set} =$	24.24	24.48	24.72	24.96	25.20	25.44	25.68	25.92	26.16	26.40	[VDC]
$R_{up} (E96) \approx$	9M53	4M87	3M24	2M49	2M	1M69	1M43	1M27	1M15	1M50	[Ω]

RPA100H-11048SRUW

Trim up	1	2	3	4	5	6	7	8	9	10	[%]
$V_{out_set} =$	48.48	48.96	49.44	49.92	50.40	50.88	51.36	51.84	52.32	52.80	[VDC]
$R_{up} (E96) \approx$	19M60	9M88	6M65	5M11	4M12	3M48	3M10	2M61	2M37	2M15	[Ω]

continued on next page

Specifications (measured @ Ta = 25°C, nom. Vin (110V), full load and after warm-up unless otherwise stated)

Trim down RPA100H series

Trim down	1	2	3	4	5	6	7	8	9	10	[%]
R _{down} (E96) ≈	499k	243k	162k	118k	90k9	75k	63k4	53k6	46k4	41k2	[Ω]
Trim down	11	12	13	14	15	16	17	18	19	20	[%]
R _{down} (E96) ≈	36k5	32k4	28k7	26k1	23k7	22k1	20k	18k2	16k5	15k4	[Ω]

EXTERNAL CAPACITOR

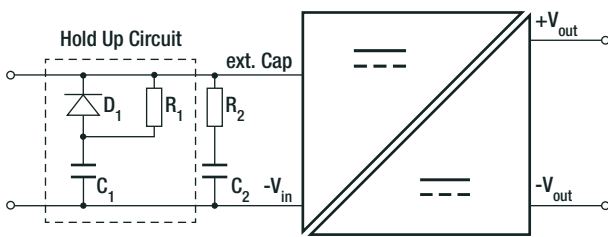

A 240µF/200V capacitor (C2) is required for normal operation. To meet power supply interruptions, an external circuit comprised of a capacitor (C1), a 100Ω/1W resistor (R1), a 200V/3A diode (D1) and a 3R/1W resistor (R2) is required.

C1	24Vin	36Vin	48Vin	72Vin	96Vin	110Vin
For 10ms	1600µF	1600µF	1600µF	1600µF	820µF	560µF
For 30ms	4800µF	4800µF	4800µF	4800µF	2460µF	1680µF

ON/OFF CONTROL

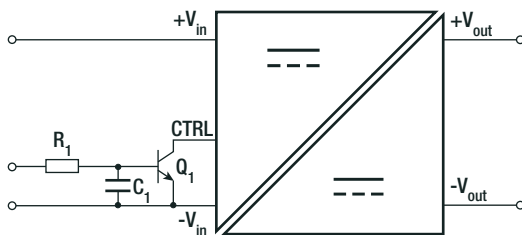

For negative logic, if the remote on/off feature is not used, short the on/off pin to -Vin.

For positive logic, if the remote on/off feature is not used, leave the on/off pin floating.

REMOTE SENSE

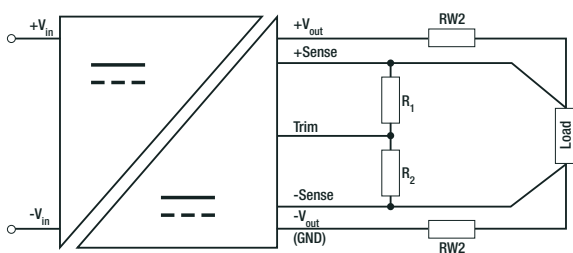

The output voltage can be adjusted by both trim and remote sense. The maximum combined adjustment range is ±10%. Derate the maximum output power if using the trim or sense function to increase the output voltage.

R_{W1} ... wire losses +
R_{W2} ... wire losses -
R₁ ... trim up resistor
R₂ ... trim down resistor

REGULATION

Parameter	Condition	Value	
Output Accuracy		±1.0% max.	
Line Regulation	V _{in} = 16.5VDC to 140VDC, I _o = full load	±0.01% typ. to ±0.2% max.	
Load Regulation	10 - 90% load	0.05% typ. to 0.2% max.	
Transient Response	25% load step change	12V _{out}	450mV/40µs typ.
		15V _{out}	450mV/30µs typ.
		24V _{out}	500mV/20µs typ.
		48V _{out}	600mV/10µs typ.

continued on next page

Specifications (measured @ Ta = 25°C, nom. Vin (110V), full load and after warm-up unless otherwise stated)

Accuracy vs. Load

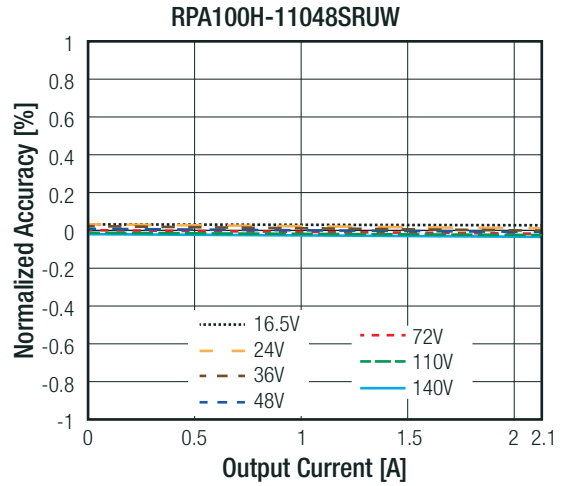
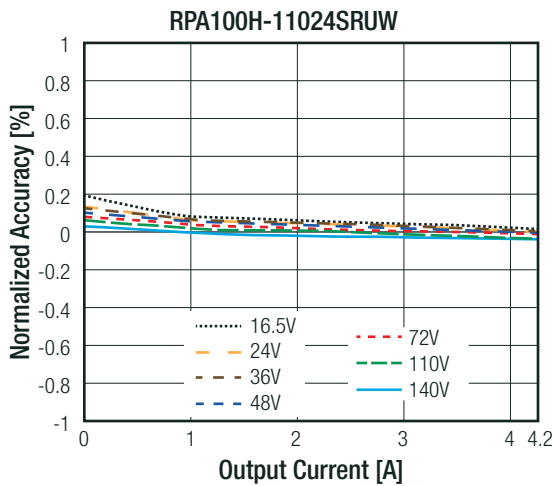
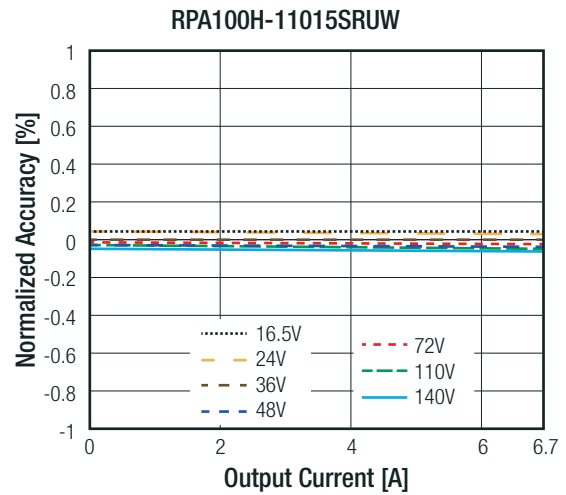
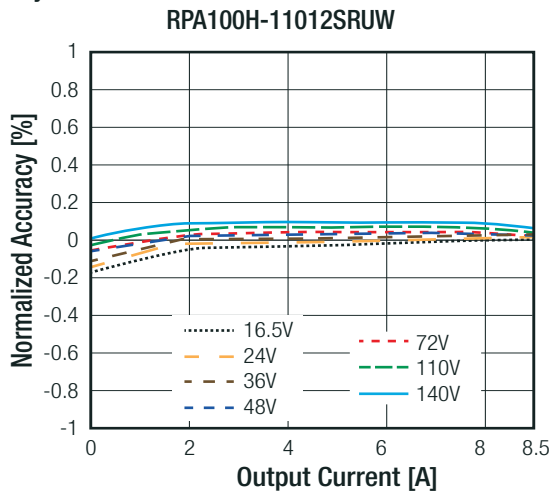

PROTECTION			
Parameter	Condition		Value
Over Voltage Protection (OVP)			110-130%, automatic recovery
Over Current Protection (OCP)			hiccup mode, automatic recovery
Over Temperature Protection (OTP)	@ tc point		+105°C, automatic recovery after cooling down
Isolation Voltage ⁽⁷⁾	I/P to O/P,	rated for 1 minute	4.242kVDC
	O/P to baseplate		4.242kVDC
Isolation Resistance			10MΩ typ.
Isolation Capacitance			500pF
Leakage Current			0.42mA
Insulation Grade			reinforced

Notes:

Note7: For repeat Hi-Pot testing, reduce the time and/or the test voltage

Note8: Refer to local safety regulations if input over-current protection is also required. Recommended fuse T20A slow blow type

Specifications (measured @ Ta = 25°C, nom. Vin (110V), full load and after warm-up unless otherwise stated)

ENVIRONMENTAL

Parameter	Condition	Value
Operating Temperature Range		refer to derating graphs
Maximum Baseplate Temperature	measured @ tc point	+100°C
Temperature Coefficient		0.007%/°C
Thermal Impedance		refer to Rth tables
Operating Altitude		5000m
Operating Humidity		5%-95% RH
Pollution Degree (PD)		PD2
Fire protection on Railway Vehicles	refer to page 9	according to EN45545-2 standard
MTBF	according to Telcordia SR332 Issue 2 Method I, 25°C	1480 x 10 ³ hours

Notes:

Note9: Following calculations are made with RPA100H-11012SRUW/P.
Test PCB: Eurocard 160x100mm 105µm copper, double layer

Thermal Derating with Fan Cooling, Double Layer PCB and Heat-sink

Thermal Impedance	
airflow [m/s]	Rth [°C/W]
0.1	3.3
0.2	2.62
0.5	2.0
0.8	1.57
1.0	1.22
1.5	0.75

Thermal Calculation Example

Io _{out} = 50%
R _{th} = 3.3°C/W
P _{Diss} = 7.87W
T _{ICmax} = 100°C

$$T_{OVER} = R_{th} \times P_{Diss} = 3.3^{\circ}\text{C/W} \times 7.87\text{W} = +26^{\circ}\text{C}$$

$$T_{AMBmax} = T_{ICmax} - T_{OVER} = 100^{\circ}\text{C} - 26^{\circ}\text{C} = +74^{\circ}\text{C}$$

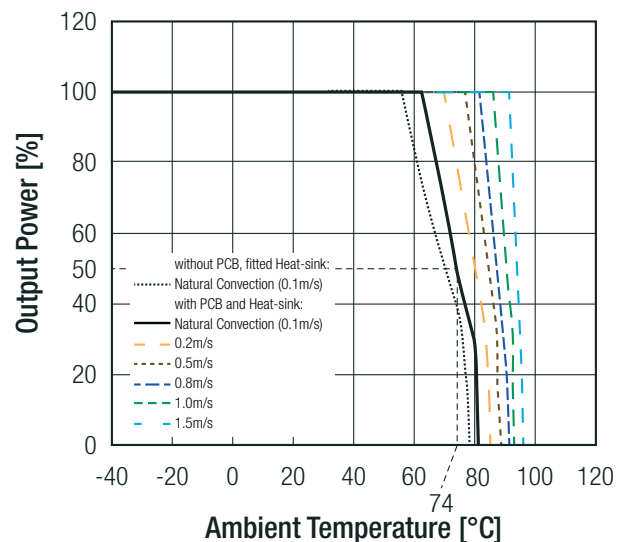

Dimension Drawing Heat-sink (mm)

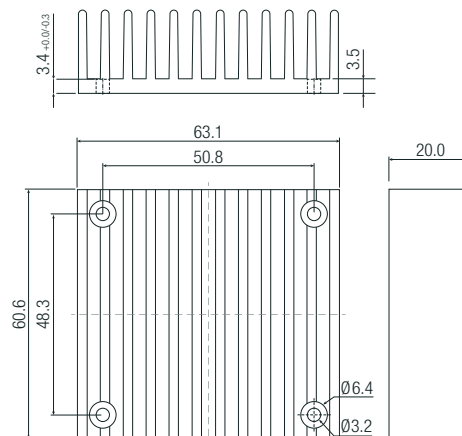

continued on next page

Specifications (measured @ Ta = 25°C, nom. Vin (110V), full load and after warm-up unless otherwise stated)

Thermal Derating with Fan Cooling and Double Layer PCB

Thermal Impedance	
airflow [m/s]	Rth [°C/W]
0.1	3.8
0.2	3.12
0.5	2.5
0.8	2.07
1.0	1.72
1.5	1.25

Thermal Calculation Example

Io _{ut} = 50%
R _{th} = 2.5°C/W
P _{Diss} = 7.87W
T _{ICmax} = 100°C

$$T_{OVER} = R_{th} \times P_{Diss} = 2.5^{\circ}\text{C/W} \times 7.87\text{W} = +20^{\circ}\text{C}$$

$$T_{AMBmax} = T_{ICmax} - T_{OVER} = 100^{\circ}\text{C} - 20^{\circ}\text{C} = +80^{\circ}\text{C}$$

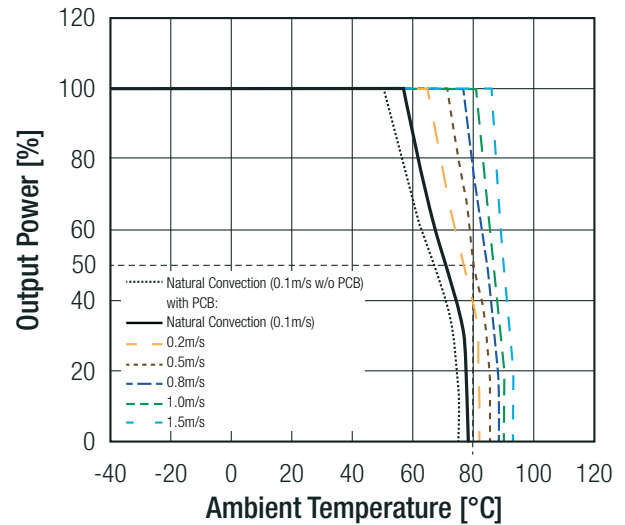

Thermal Derating with Water Cooling

Thermal Impedance	
liquid flow [l/min]	Rth [°C/W]
2.3	0.31

Thermal Calculation Example

Io _{ut} = 100%
R _{th} = 0.31°C/W
P _{Diss} = 10.94W
T _{ICmax} = 100°C

$$T_{OVER} = R_{th} \times P_{Diss} = 0.31^{\circ}\text{C/W} \times 10.94\text{W} = +3.4^{\circ}\text{C}$$

$$T_{AMBmax} = T_{ICmax} - T_{OVER} = 100^{\circ}\text{C} - 3.4^{\circ}\text{C} = +97^{\circ}\text{C}$$

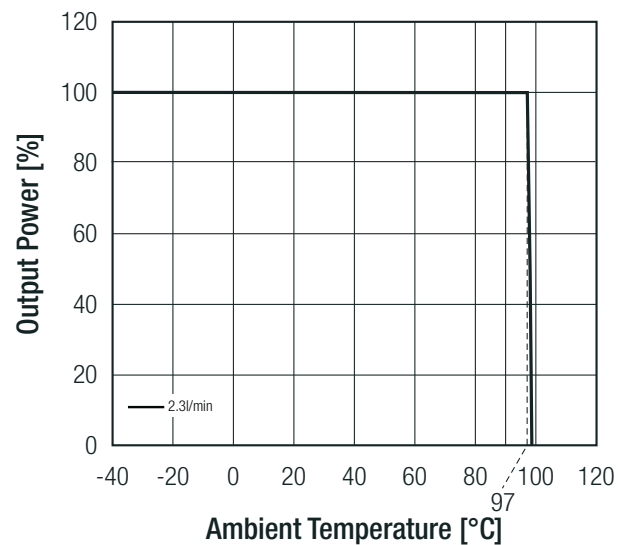

Notes:

Note10: For further details please contact our Tech Support Team techsupportAT@recom-power.com

SAFETY AND CERTIFICATIONS

Certificate Type (Safety)	Report / File Number	Standard
Information Technology Equipment, General Requirements for Safety	E224736-A54-UL and E224736-A57-UL	UL60950-1, 2nd Edition: 2014 CAN/CSA-C22.2 No. 60950-1-07, 2nd Edition: 2014
IEC/EN Information Technology Equipment - General Requirements for Safety (CB Scheme)	E224736-A54-CB-1 and E224736-A57-CB-1	IEC60950-1: 2005, 2nd Edition + AM2: 2013
IEC/EN Information Technology Equipment - General Requirements for Safety		EN60950-1: 2006 + A2: 2013

continued on next page

Specifications (measured @ Ta = 25°C, nom. Vin (110V), full load and after warm-up unless otherwise stated)

Fire hazard testing - Part 11-10: Test flames - 50W horizontal and vertical flame test methods	Vertical Flame Test	EN60695-11-10: 2013, HL1, HL2, HL3, V-0
Fire hazard testing - Part 2-11: Glowing/hot-wire based test methods; Glow-wire flammability test method for end-products	Glow-Wire Flammability Test 30s ta, 850°C	EN60695-2-11:2000, HL1, HL2, HL3
Plastics - Determination of burning behaviour by oxygen index - Part 2: Ambient-temperature test	OI% (min) 42.6% OI% (min) 36.8%	EN ISO 4589-2:2006, HL1, HL2, HL3 EN ISO 4589-2:1999 + A1:2006, HL1, HL2, HL3
Railway Applications - Electrical Equipment used on rolling stock		EN50155:2007
Railway applications - Fire protection on railway vehicles Part 2: Requirements for fire behaviour of materials and components		EN45545-2:2013 + A1:2015
EAC	RU-AT.49.09571	TP TC 004/2011
RoHS2		RoHS 2011/65/EU + AM2015/863

EMC Compliance	Condition	Standard / Criterion
Railway applications - Electromagnetic compatibility - Part 3-2: Rolling stock - Apparatus	with external components	EN50121-3-2:2015
ESD Electrostatic discharge immunity test	Air ±8kV, Contact ±6kV	EN61000-4-2, Criteria B
Radiated, radio-frequency, electromagnetic field immunity test	80-1000MHz, 20V/m 800-1000MHz, 20V/m 1400-2100MHz, 10V/m 2100-2500MHz, 5V/m	EN61000-4-3, Criteria A
Fast Transient and Burst Immunity	±2kV	EN61000-4-4, Criteria A
Surge Immunity	±1kV (diff), ±2kV (com)	EN61000-4-5, Criteria B
Immunity to conducted disturbances, induced by radio-frequency fields	10V	EN61000-4-6, Criteria A
Electromagnetic compatibility of multimedia equipment - Emission requirements	with external components	EN55032, Class B

EMC Filtering according to EN50121-3-2

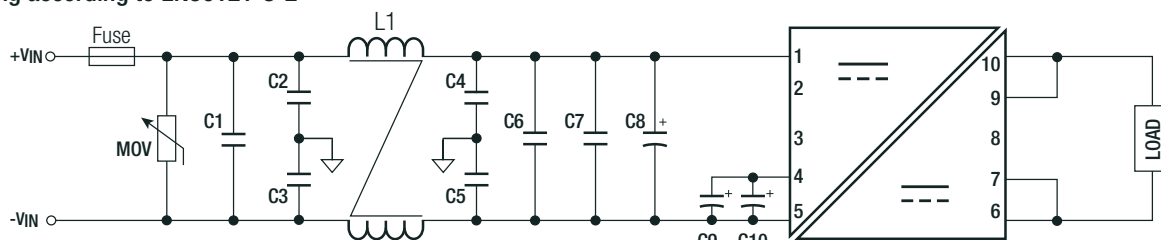

MOV	C1	C2, C3, C4, C5	L1	C6, C7	C8	C9, C10
EPCOS B72207S0131K101	100nF 275VAC	1000pF, 300VAC	1mH CMC	0.47µF 250V	100µF 200V	120µF 200V

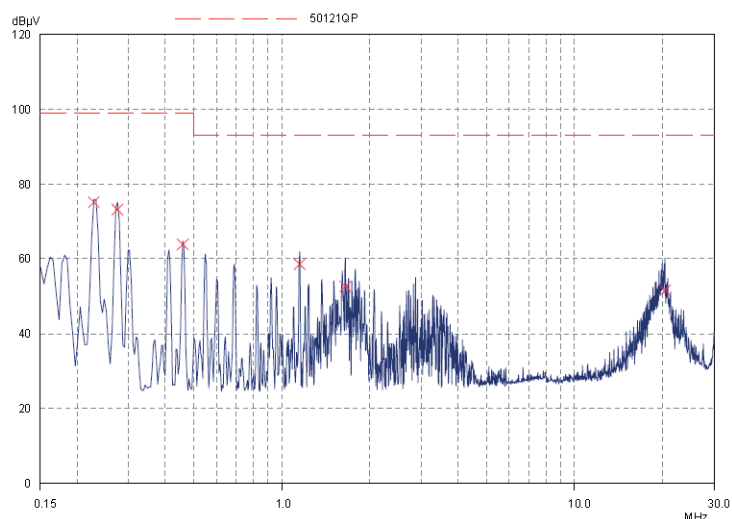

continued on next page

Specifications (measured @ Ta = 25°C, nom. Vin (110V), full load and after warm-up unless otherwise stated)

EMC Filtering according to EN55032 Class B

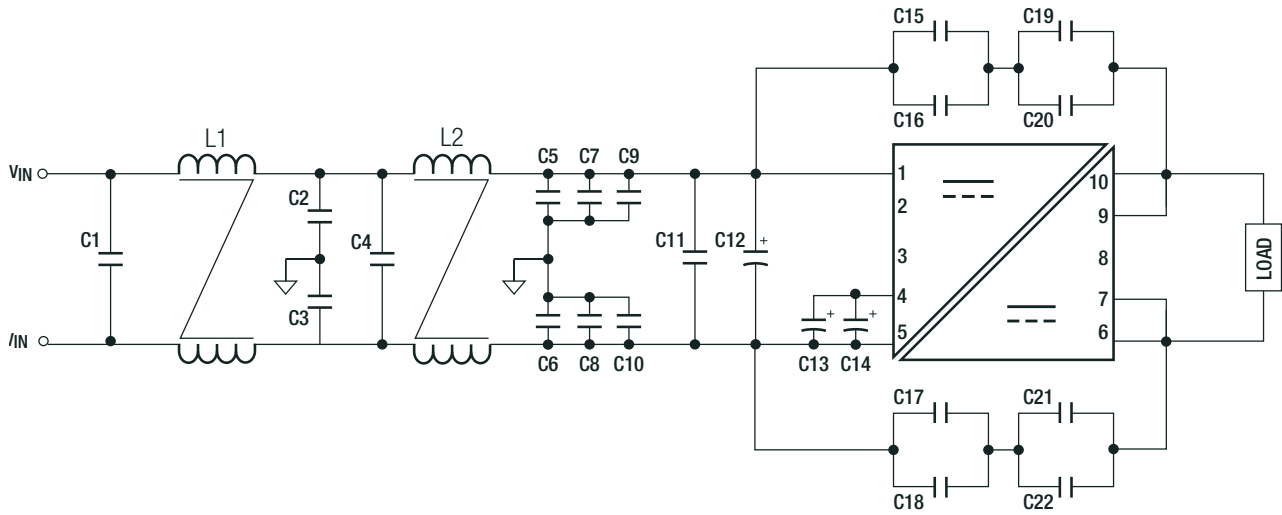

C1, C4, C11	L1, L2	C2, C3, C5, C6, C7, C8, C9, C10	C12	C13, C14	C15, C16, C17, C18, C19, C20
0.47µF, 250V MLCC	1mH CMC	1.5nF, 3kV	100µF 200V	120µF 200V	6.8nF, 2kV

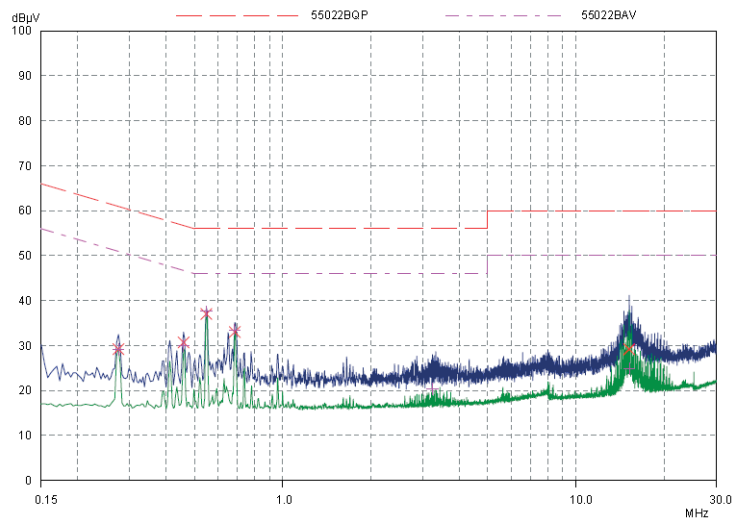

DIMENSIONS and PHYSICAL CHARACTERISTICS

Parameter	Type	Value
Material	baseplate case potting	aluminum plastic (UL94V-2) low smoke silicone (UL94V-0)
Package Dimensions (LxWxH)		60.6 x 63.1 x 13.0mm
Package Weight		125.0g typ.

continued on next page

Specifications (measured @ Ta = 25°C, nom. Vin (110V), full load and after warm-up unless otherwise stated)

Dimension Drawing (mm)

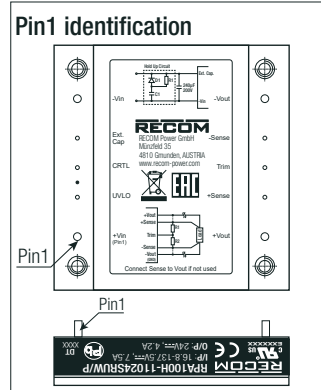
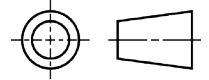
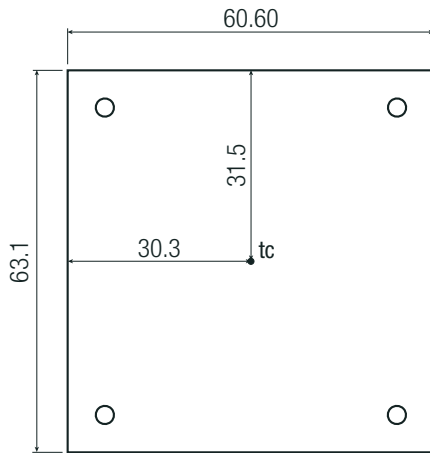

Pin Connections

Pin #	Single
1	+Vin
2	UVLO
3	CTRL
4	Ext. Cap.
5	-Vin
6	-Vout
7	-Sense
8	Trim
9	+Sense
10	+Vout

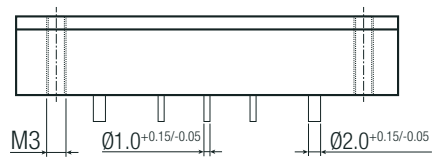
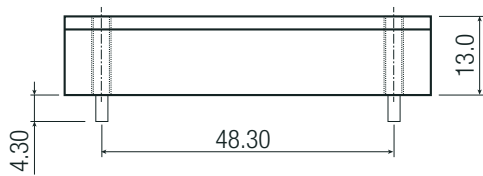

XX.X ± 0.5mm
 XX.XX ± 0.25mm
 FC= fixing center

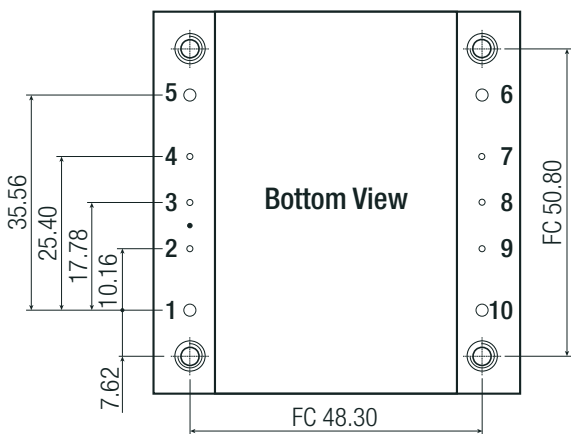

Recommended Footprint Details

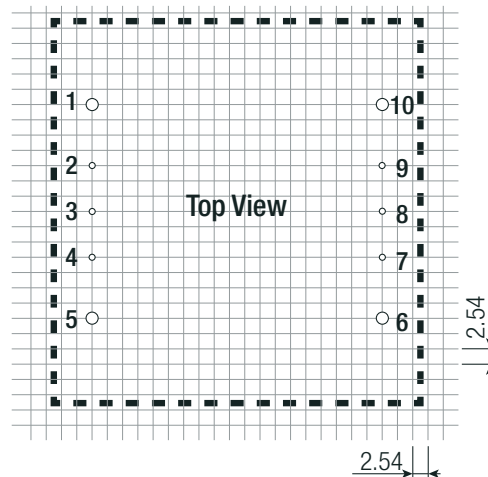

Specifications (measured @ Ta = 25°C, nom. Vin (110V), full load and after warm-up unless otherwise stated)

BLOCK DIAGRAMM

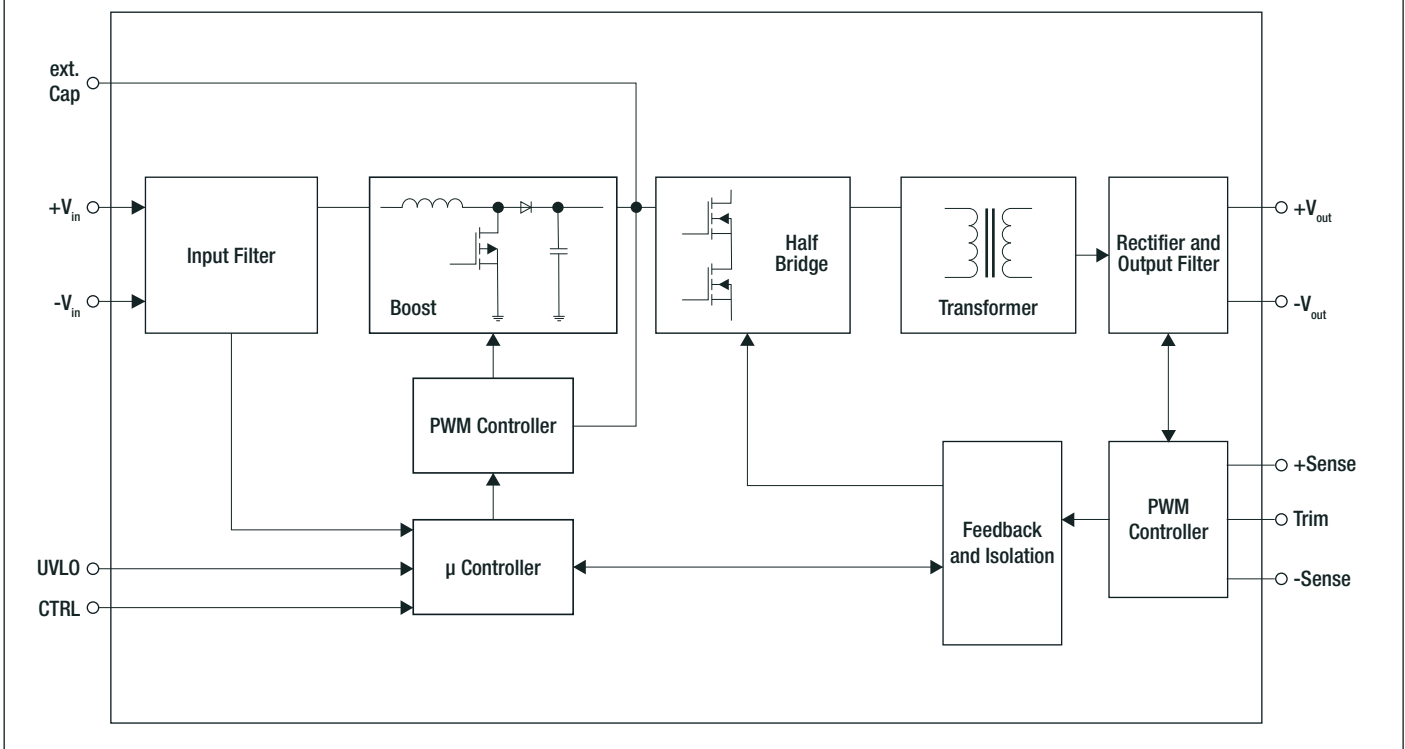

PACKAGING INFORMATION

Parameter	Type	Value
Packaging Dimensions (LxWxH)	tube	355.0 x 63.5 x 20.6mm
Packaging Quantity		5pcs
Storage Temperature Range		-55°C to +125°C
Storage Humidity		95% RH

The product information and specifications may be subject to changes even without prior written notice. The product has been designed for various applications; its suitability lies in the responsibility of each customer. The products are not authorized for use in safety-critical applications without RECOM's explicit written consent. A safety-critical application is an application where a failure may reasonably be expected to endanger or cause loss of life, inflict bodily harm or damage property. The applicant shall indemnify and hold harmless RECOM, its affiliated companies and its representatives against any damage claims in connection with the unauthorized use of RECOM products in such safety-critical applications.

X-ON Electronics

Largest Supplier of Electrical and Electronic Components

Click to view similar products for [Isolated DC/DC Converters](#) category:

Click to view products by [Recom Power](#) manufacturer:

Other Similar products are found below :

[ESM6D044440C05AAQ](#) [FMD15.24G](#) [PSL486-7LR](#) [Q48T30020-NBB0](#) [JAHW100Y1](#) [SPB05C-12](#) [SQ24S15033-PS0S](#) [18952](#) [19-130041](#)
[CE-1003](#) [CE-1004](#) [GQ2541-7R](#) [RDS180245](#) [MAU228](#) [J80-0041NL](#) [DFC15U48D15](#) [XGS-0512](#) [XGS-1205](#) [XGS-1212](#) [XGS-2412](#) [XGS-2415](#) [XKS-1215](#) [06322](#) [NCT1000N040R050B](#) [SPB05B-15](#) [SPB05C-15](#) [L-DA20](#) [DCG40-5G](#) [QME48T40033-PGB0](#) [XKS-2415](#) [XKS-2412](#)
[XKS-1212](#) [XKS-1205](#) [XKS-0515](#) [XKS-0505](#) [XGS-2405](#) [XGS-1215](#) [XGS-0515](#) [PS9Z-6RM4](#) [73-551-5038I](#) [AK1601-9RT](#) [VI-N61-CM](#) [VI-R5022-EXWW](#) [PSC128-7iR](#) [RPS8-350ATX-XE](#) [DAS1004812](#) [PQA30-D24-S24-DH](#) [VI-M5F-CQ](#) [VI-LN2-EW](#) [VI-PJW01-CZY](#)