

FEATURES

- Evaluation platform for RPH-3.0 Buck Regulator Module
- Thermal design considerations included
- EMI Class B filter
- Easy evaluation of control, power good, and sensing functions

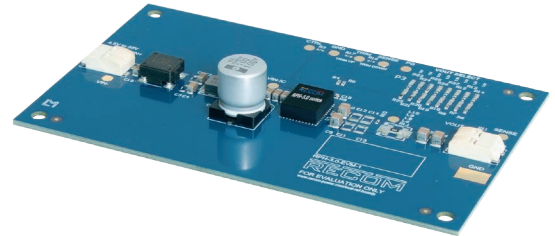

DESCRIPTION

The RPH-3.0-EVM-1 generates a constant output voltage with an output current up to 3A from an external DC source. All the functions of the RPH-3.0-EVM-1 like trimming, control, and sensing can be evaluated. Also the behavior in overload or over temperature can be evaluated easily before it is designed in.

SELECTION GUIDE

Part Number	Input Voltage Range [VDC]	Output Voltage [VDC]	Output Current max. [mA]	Switching Frequency [kHz]
RPH-3.0-EVM-1	4.5-55	1.0, 1.2, 1.8, 2.5, 3.3, 5.0, 12, 15	3000	100-1000

Quick Start Guide:

1. Connect P1 to power supply (observe correct polarity!)
2. Connect P2 to a Load
3. The evaluation module is preset to $V_{OUT} = 5.0VDC$.
The output voltage can be selected with values of 1.0V, 1.2V, 1.8V, 2.5V, 3.3V, 5.0V, 12V and 15V by shorting a 0Ω resistor to the respective places as seen in the board silkscreen.
The default sense preset via R25 is directly at the output of the filter. To change sensing point to the output of the module, remove the resistor at R11, and solder a 0Ω resistor at R10.
4. Disable the device via R2
The device is preset as normally on. It can be disabled by pulling the CTRL pad to GND.
Short R2 to disable the device.



Caution:

ESD sensitive. Always follow ESD preventative procedures when handling the product!

COMPONENT PLACEMENT

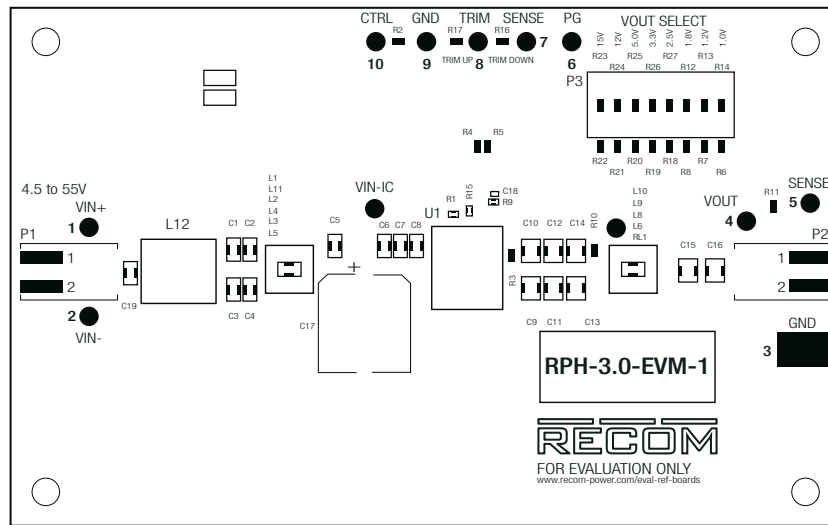

Connector Description

Pads direct connection

Name	Description
VIN	Positive Input Voltage (observe correct polarity!)
VIN-	Negative Input Voltage (separated from GND through common mode choke)
GND	Common GND (can connect oscilloscope GND for measurement)
VOUT	Positive Output Voltage
SENSE	Output Voltage Sense Pin (leave open if not used)
PGOOD	Power good signal
SENSE	Output Voltage Sense Pin (leave open if not used)
TRIM	Trim Pin (leave open if not used)
GND	Common GND
CTRL	CTRL Pin (leave open if not used)

P1

Pin	Name	Description
1	VIN	Positive Input Voltage (observe correct polarity!)
2	VIN-	Negative Input Voltage (separated from GND through common mode choke)

P2

Pin	Name	Description
1	VOUT	Power Output Voltage
2	GND	Common GND

SCHEMATIC

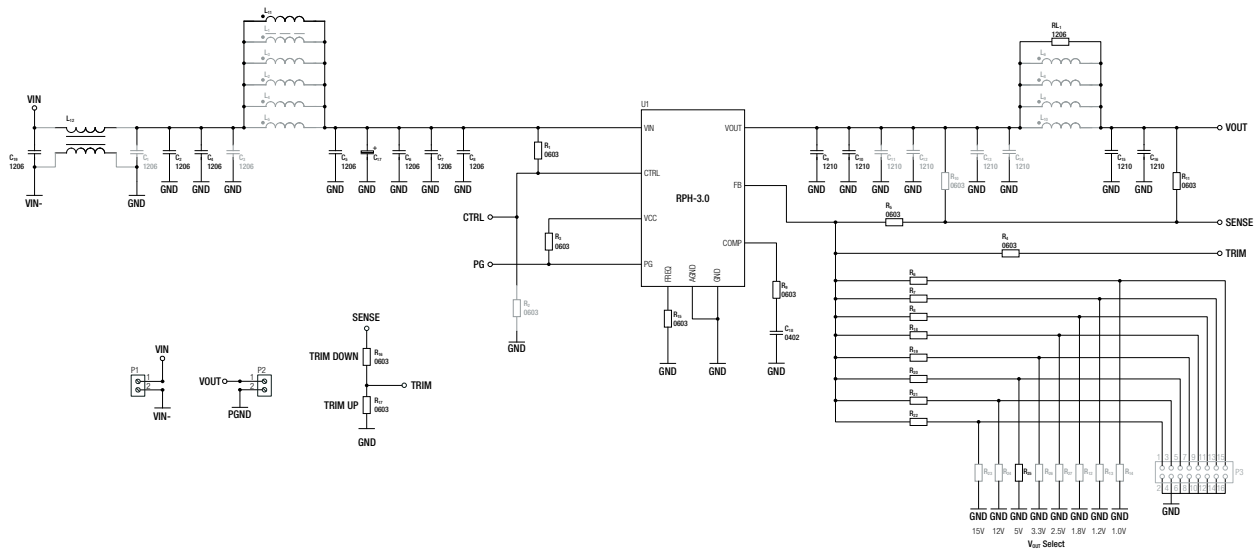

Note1: Gray colored components are not mounted.

DESCRIPTION

U1: RPH-3.0 power module.

C19,C1,C2,C3,C4,L1,L2,L3,L4,L5,L11,C5,C6,C7,C8,C17: allow placement of various sized components to test input filter design. The populated filter is designed to meet EN55032 class B

C9,C10,C11,C12,C13,C14,R11,L6,L8,L9,L10,C15,C16: allow placement of various sized components to test output filter design. The populated filter is designed to meet EN55032 class B

R2: connect 0Ω resistor to disable the module. This resistor is not populated.

R3: populated 100kΩ resistor which is pulled up to VDD. This is for output power good signal.

R10: not populated. 0Ω resistor for direct output voltage measurement. If sense is desired at a different location, for example after the filter or directly at the load), desolder R10, and connect sense to the new measurement point.

R11: sense point for output voltage after the filter. To set sense point here, remove R10 and solder a 0Ω resistor at R11.

R15: See „Switching Frequency Recommendation“

R16 and R17: trim the output voltage. See „Output Voltage Trimming“

SWITCHING FREQUENCY RECOMMENDATION

R15: populated 102kΩ resistor. This sets the switching frequency to 500kHz. For output voltages 1.0V, 1.2V, and 1.8V, output voltage ripple could be optimized by changing the frequency when used at input voltage greater than 24V. Set the frequency to 150kHz by changing this resistor to 390kΩ.

OUTPUT VOLTAGE TRIMMING

The RPH-3.0-EVM-1 offers the feature of trimming the output voltage by using external trim resistors. The values for the trim resistors in trim tables are according to standard E96 values; therefore, the specified voltage may slightly vary.

Calculation:

- V_{OUT} = nom. output voltage [VDC]
- V_{out_set} = trimmed output voltage [VDC]
- V_{ref} = reference voltage [VDC]
- R_{up} = trim up resistor [Ω]
- R_{down} = trim down resistor [Ω]
- R_1, R_2, R_3 = feedback resistors [Ω]

V_{OUT} [VDC]	R_1 [Ω]	R_2 [Ω]	R_3 [Ω]	V_{ref}
1.0	10k	open	1k	1VDC
1.2		49k9		
1.8		12k4		
2.5		6k65		
3.3		4k3		
5.0		2k49		
12		909		
15		715		

$$R_{up} = \frac{[(V_{set} - V_{ref})(R_2 R_3)] - [(R_1 \times V_{ref})(R_2 + R_3)]}{V_{ref}(R_1 + R_2) - R_2 \times V_{set}} = [k\Omega]$$

$$R_{down} = \frac{(V_{set} - V_{ref})(R_1 R_2 + R_2 R_3) - V_{ref}(R_1 R_3)}{V_{ref}(R_1 + R_2) - V_{set}(R_2)} = [k\Omega]$$

Practical Example RPH-3.0, trim up:

$$R_{up} = \frac{[(6 - 1)(2.49k \times 1k)] - [(10k \times 1k)(2.49k + 1k)]}{[1 \times (10k + 2.49k)] - (2.49k \times 6)}$$

$R_{up} = 9k09\Omega$ (according to E96 1%)

Practical Example RPH-3.0, trim down:

$$R_{down} = \frac{(4 - 1)[(10k \times 2.49k) + (2.49k \times 1k)] - (1 \times 10k \times 1k)}{[1 \times (10k + 2.49k)] - (4 \times 2.49k)}$$

$R_{down} = 28k7\Omega$ (according to E96 1%)

$V_{out_set} = 1.0VDC$

Trim up

$V_{out_set} =$	1.1	[VDC]
R_{up} (E96) \approx	100k	[Ω]

$V_{out_set} = 1.2VDC$

Trim up

$V_{out_set} =$	1.3	1.44	[VDC]
R_{up} (E96) \approx	100k	41k2	[Ω]

Trim down

$V_{out_set} =$	1.08	[VDC]
R_{down} (E96) \approx	5k62	[Ω]

$V_{out_set} = 1.8VDC$

Trim up

$V_{out_set} =$	1.9	2	[VDC]
R_{up} (E96) \approx	105k	51k1	[Ω]

Trim down

$V_{out_set} =$	1.7	1.6	1.5	[VDC]
R_{down} (E96) \approx	64k9	28k	15k4	[Ω]

$V_{out_set} = 2.5VDC$

Trim up

$V_{out_set} =$	2.6	2.8	3.0	[VDC]
R_{up} (E96) \approx	102k	32k4	19k1	[Ω]

Trim down

$V_{out_set} =$	2.2	2.1	2.0	[VDC]
R_{down} (E96) \approx	38k3	26k1	18k7	[Ω]

$V_{out_set} = 3.3VDC$

Trim up

$V_{out_set} =$	3.4	3.5	3.63	3.96	[VDC]
R_{up} (E96) \approx	133k	56k2	31k6	14k7	[Ω]

Trim down

$V_{out_set} =$	2.9	[VDC]
R_{down} (E96) \approx	43k2	[Ω]

$V_{out_set} = 5.0VDC$

Trim up

$V_{out_set} =$	5.5	6.0	[VDC]
R_{up} (E96) \approx	19k6	9k09	[Ω]

Trim down

$V_{out_set} =$	4	[VDC]
R_{down} (E96) \approx	28k7	[Ω]

OUTPUT VOLTAGE TRIMMING

$V_{out_set} = 12VDC$

Trim up

$V_{out_set} =$	13.2	14.4	[VDC]
$R_{up} (E96) \approx$	7k32	3k16	[Ω]

Trim down

$V_{out_set} =$	10.8	9.6	[VDC]
$R_{down} (E96) \approx$	80k6	34k8	[Ω]

$V_{out_set} = 15VDC$

Trim down

$V_{out_set} =$	13.5	[VDC]
$R_{down} (E96) \approx$	82k5	[Ω]

DIMENSION & PHYSICAL CHARACTERISTICS

Parameter	Type	Value
Dimension (LxWxH)		120.0 x 75.0 x 25.0mm 0.86 x 0.36 x 0.44inch
Weight		45g typ. 0.10 lbs

Top Layer

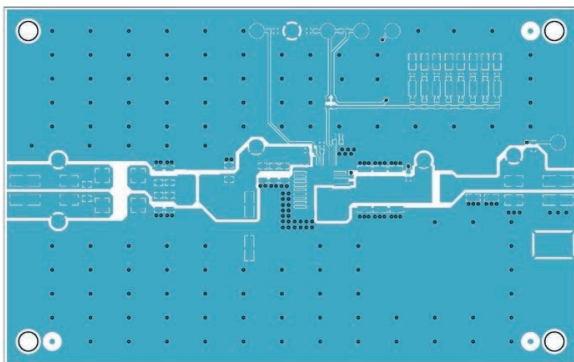

Layer 2

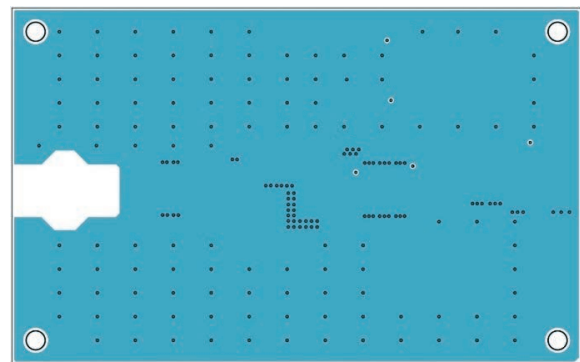

Layer 3

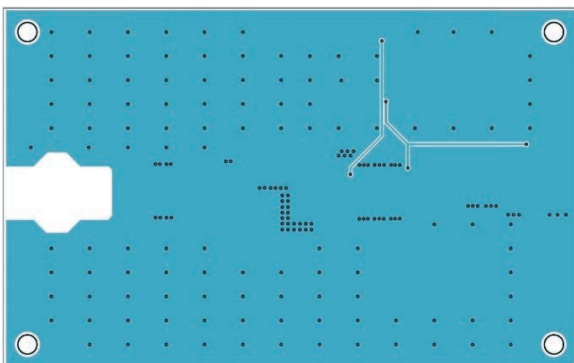

Bottom Layer

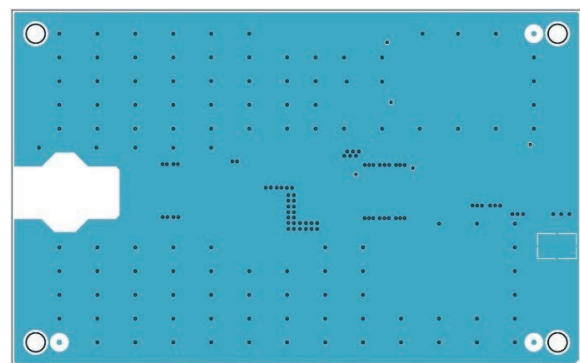

Note2: Visit www.recom-power.com/eval-ref-boards to download Gerber files

RPH-3.0-EVM-1 ◊ Evaluation Module

3 Amp ◊ Input: 4.5-55VDC

BOM				
Component	Description	Manufacturer Part Number	Manufacturer	Remarks
C1	1206			Not Mounted
C2	4.7µF X7R 100VDC 1206	GRJ31CZ72A475KE01L	MURATA	
C3	1206			Not Mounted
C4	4.7µF X7R 100VDC 1206	GRJ31CZ72A475KE01L	MURATA	
C5	4.7µF X7R 100VDC 1206	GRJ31CZ72A475KE01L	MURATA	
C6	4.7µF X7R 100VDC 1206	GRJ31CZ72A475KE01L	MURATA	
C7	4.7µF X7R 100VDC 1206	GRJ31CZ72A475KE01L	MURATA	
C8	4.7µF X7R 100VDC 1206	GRJ31CZ72A475KE01L	MURATA	
C9	22µF X7S 25VDC 1210	GCJ32EC71E226KE02L	MURATA	
C10	22µF X7S 25VDC 1210	GCJ32EC71E226KE02L	MURATA	
C11	1210			Not Mounted
C12	1210			Not Mounted
C13	1210			Not Mounted
C14	1210			Not Mounted
C15	22µF X7S 25VDC 1210	GCJ32EC71E226KE02L	MURATA	
C16	22µF X7S 25VDC 1210	GCJ32EC71E226KE02L	MURATA	
C17	100µF 100V 13x13.5	EMVY101ARA101MKE0S	UNITED CHEMI-CON	
C18	2.2nF X7R 50VDC 0402	CLO5B222KB5NUNC	SAMSUNG ELECTRO-MECHANICS	
C19	4.7µF X7R 100VDC 1206	GRJ31CZ72A475KE01L	MURATA	
L1	FERRITE BEAD			Not Mounted
L2	FIXED IND SMT			Not Mounted
L3	FIXED IND SMT			Not Mounted
L4	POWER INDUCTOR SMT			Not Mounted
L5	FIXED IND SMT			Not Mounted
L6	FERRITE BEAD 1206			Not Mounted
L8	POWER INDUCTOR SMT			Not Mounted
L9	FIXED IND SMT			Not Mounted
L10	FIXED IND SMT			Not Mounted
L11	FIXED IND 4.7UH 3.8A SMT	0530CDMCCDS-4R7MC	SUMIDA	
L12	CMC 9µH 3.5A	744273801	WURTH	
P1	CONNECTOR	695402400222	WURTH	
P2	CONNECTOR	695402400222	WURTH	
P3	CONNECTOR			Not Mounted
R1	1M 0.1W 1% 0603	CRCW06031M00FKEA	VISHAY	
R2	0603			Not Mounted
R3	100K 0.1W 1% 0603	RC0603FR-07100KL	YAGEO	
R4	1K 0.1W 1% 0603	RC0603FR-071KL	YAGEO	
R5	10K 0.1W 1% 0603	RC0603FR-0710KL	YAGEO	
R6				Not Mounted
R7	49.9K 0.1W 1% 0603	RC0603FR-0749K9L	YAGEO	
R8	12.4K 0.1W 1% 0603	CRCW060312K4FKEAC	VISHAY	
R9	2.52K 0.1W 1% 0603	RN73H1JT2521F100	KOA Speer	
R10	0603			Not Mounted
R11	0R 0.1W 0603	RC0603JR-070RL	YAGEO	
R12	0603			Not Mounted
R13	0603			Not Mounted
R14	0603			Not Mounted
R15	102K 0.1W 1% 0603	ERJ-U03F1023V	PANASONIC	
R16	0603			Not Mounted

RPH-3.0-EVM-1 ◊ Evaluation Module

3 Amp ◊ Input: 4.5-55VDC

BOM

Component	Description	Manufacturer Part Number	Manufacturer	Remarks
R17	0603			Not Mounted
R18	6.65K 0.1W 1% 0603	CRCW06036K65FKEAC	VISHAY	
R19	4.3K 0.1W 1% 0603	CRCW06034K30FKEAC	VISHAY	
R20	2.49K 0.1W 1% 0603	CRCW06032K49FKEA	VISHAY	
R21	909R 0.1W 1% 0603	CRCW0603909RFKEAC	VISHAY	
R22	715R 0.1W 1% 0603	CRCW0603715RFKEAC	VISHAY	
R23	0603			Not Mounted
R24	0603			Not Mounted
R25	0R 0.1W 0603	RC0603JR-070RL	YAGEO	
R26	0603			Not Mounted
R27	0603			Not Mounted
RL1	0R 0.25W 1206	CRCW12060000Z0EAC	VISHAY	
U1	RPH-3.0 MODULE	RPH-3.0	RECOM	

PACKAGING INFORMATION

Parameter	Type	Value
Packaging Dimension (LxWxH)	single box	205.0 x 135.0 x 43.0mm
Packaging Quantity		1pc

CONTENTS

- RPH-3.0-EVM-1 Evaluation Module
- Terms and conditions

The product information and specifications may be subject to changes even without prior written notice. The product has been designed for various applications; its suitability lies in the responsibility of each customer. The products are not authorized for use in safety-critical applications without RECOM's explicit written consent. A safety-critical application is an application where a failure may reasonably be expected to endanger or cause loss of life, inflict bodily harm or damage property. The applicant shall indemnify and hold harmless RECOM, its affiliated companies and its representatives against any damage claims in connection with the unauthorized use of RECOM products in such safety-critical applications.

X-ON Electronics

Largest Supplier of Electrical and Electronic Components

Click to view similar products for [Power Management IC Development Tools](#) category:

Click to view products by [RECOM POWER](#) manufacturer:

Other Similar products are found below :

[EVB-EP5348UI](#) [BQ25010EVM](#) [ISL80019AEVAL1Z](#) [ISLUSBI2CKIT1Z](#) [ISL8002AEVAL1Z](#) [ISL91108IIA-EVZ](#) [ISL28022EVKIT1Z](#)
[STEVAL-ISA008V1](#) [DRI0043](#) [KITPF8100FRDMEVM](#) [NCP10671B05GEVB](#) [EVB-EN6337QA](#) [SAMPLEBOXILD8150TOBO1](#)
[AP62300WU-EVM](#) [KITA2GTC387MOTORCTRTOBO1](#) [AEK-MOT-TK200G1](#) [EVLONE65W](#) [STEVAL-ILH006V1](#) [STEVAL-IPE008V2](#)
[STEVAL-IPP001V2](#) [STEVAL-ISA013V1](#) [STEVAL-ISA067V1](#) [STEVAL-ISQ002V1](#) [TPS2306EVM-001](#) [TPS2330EVM-185](#)
[TPS40001EVM-001](#) [SECO-HVDCDC1362-15W-GEVB](#) [BTS7030-2EPA](#) [LT8638SJV#WPBF](#) [LTC3308AIV#WTRPBF](#) [TLT807B0EPV](#)
[LT8641IUDC#WTRPBF](#) [BTS71033-6ESA](#) [EV13N91A](#) [EASYPIC V8 OVER USB-C](#) [EV55W64A](#) [RPZ-1.0-EVM-1](#) [CLICKER 4 FOR](#)
[STM32F4](#) [RPH-3.0-EVM-1](#) [RPZ-6.0-EVM-1](#) [RPZ-3.0A-EVM-1](#) [EASYMX PRO V7A FOR STM32](#) [RPL-1.0-EVM-1](#) [CLICKER 4 FOR](#)
[PIC18F](#) [RPL-20-EVM-1](#) [RPL-10-EVM-1](#) [RPZ-2.0-EVM-1](#) [RB-TO2S2](#) [RB-TSR1S2](#) [RDP-02](#)