

RPL-5.0-EVM-1 ◊ Evaluation Module

5 Amp ◊ Input: 2.75-17VDC

FEATURES

- Evaluation platform for RPL-5.0 Buck Regulator Module
- Thermal design considerations included
- EMI Class B filter
- Easy evaluation of control, power good, soft-start, and sensing functions

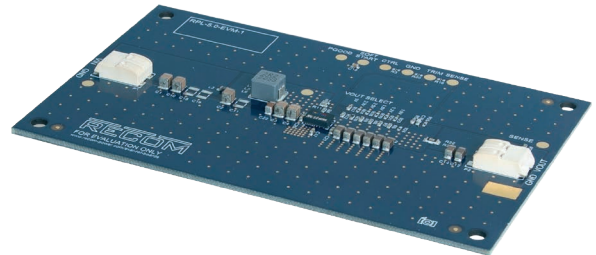

DESCRIPTION

The RPL-5.0-EVM-1 generates a constant output voltage with an output current up to 5A from an external DC source. All the functions of the RPL-5.0-EVM-1 like trimming, control, soft-start, and sensing can be evaluated. Also the behavior in overload or over temperature can be evaluated easily before it is designed in.

SELECTION GUIDE

Part Number	Input Voltage Range [VDC]	Output Voltage [VDC]	Output Current max. [mA]	Switching Frequency [kHz]
RPL-5.0-EVM-1	2.75-17	1.0, 1.2, 1.8, 2.5, 3.3, 5.0	5000	900-1600

Quick Start Guide:

1. Connect P1 to power supply (observe correct polarity!)
2. Connect P2 to a Load
3. The evaluation module is preset to $V_{OUT} = 3.3VDC$.
The output voltage can be selected with values of 1.0V, 1.2V, 1.8V, 2.5V, 3.3V and 5V by shorting a 0Ω resistor to the respective places as seen in the board silkscreen.
4. Disable the device via R3
The device is preset as normally on. It can be disabled by pulling the CTRL pad to GND. Short R3 to disable the device.



Caution:

ESD sensitive. Always follow ESD preventative procedures when handling the product!

COMPONENT PLACEMENT

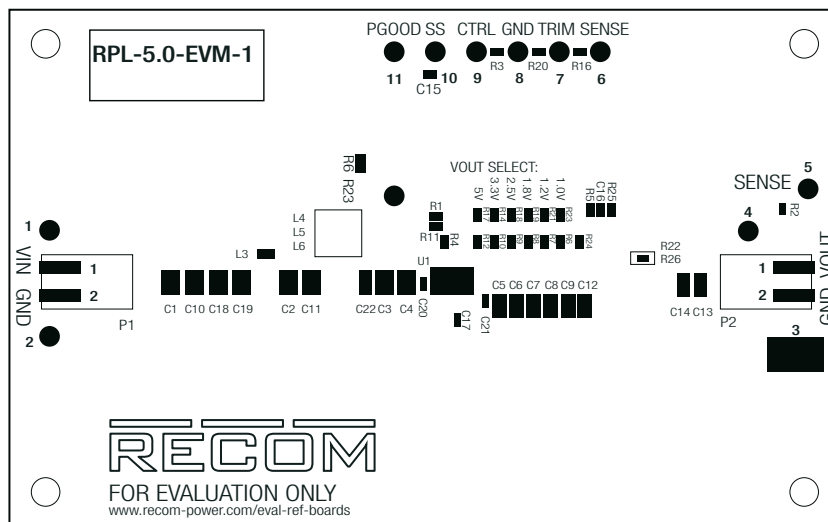

Connector Description

Pads direct connection

Pin	Name	Description
1	VIN	Positive Input Voltage
2	GND	Common GND
3	GND	Common GND, can connect oscilloscope GND for measurement
4	VOUT	Positive Output Voltage
5	SENSE	Output Voltage Sense Pin (leave open if not used)
6	SENSE	Output Voltage Sense Pin (leave open if not used)
7	TRIM	Trim Pin (leave open if not used)
8	GND	Common GND
9	CTRL	CTRL Pin (leave open if not used)
10	SOFT START	Soft Start Pin
11	PGOOD	Power Good Signal

P1

Pin	Name	Description
1	VIN	Positive Input Voltage (observe correct polarity!)
2	GND	Common GND

P2

Pin	Name	Description
1	VOUT	Positive Output Voltage
2	GND	Common GND

SCHEMATIC

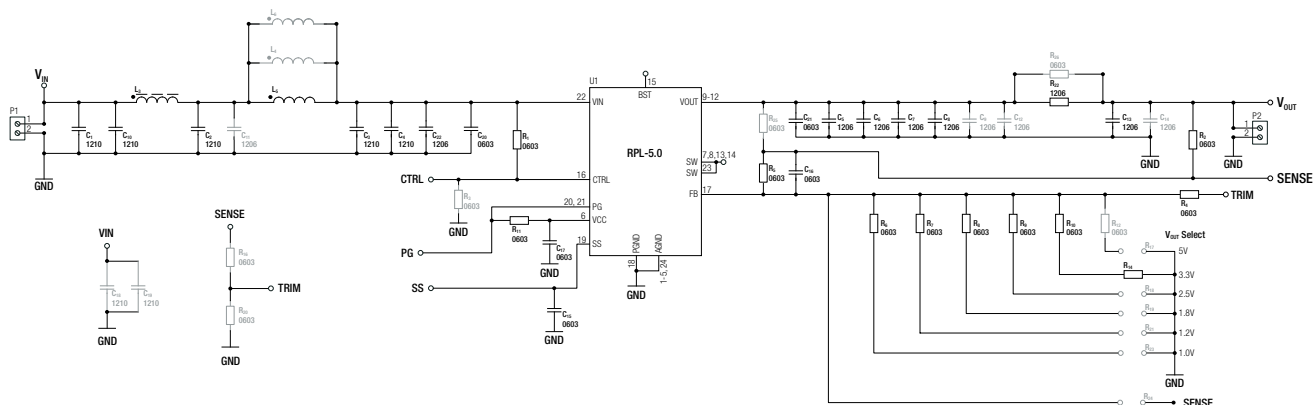

Note1: Gray colored components are not mounted.

DESCRIPTION

U1: RPL-5.0 power module.

C1,C10,C18,C19,L3,C2,C11,L4,L5,L6,C3,C4,C20,C22: allow placement of various sized components to test input filter design. The populated filter is designed to meet EN55032 class B

C21,C5,C6,C7,C8,C9,C12,R22,R26,C13,C14: allow placement of various sized components to test output filter design. The populated filter is designed to meet EN55032 class B

R3: connect 0Ω resistor to disable the module. This resistor is not populated.

C15: Sets the soft-start time. Refer to U1 datasheet for more information.

R11: populated 100kΩ resistor which is pulled up to VCC. This is for output power good signal.

R2: populated 0Ω resistor sense point for output voltage after the filter.

R25: 0Ω resistor for direct output voltage measurement. If sense is desired at a different location, for example after the filter or directly at the load), desolder R2, and connect sense to the new measurement point.

R16 and R20: trim the output voltage. See „**Output Voltage Trimming**“

OUTPUT VOLTAGE TRIMMING

The RPL-5.0-EVM-1 offers the feature of trimming the output voltage by using external trim resistors. The values for the trim resistors in trim tables are according to standard E96 values; therefore, the specified voltage may slightly vary.

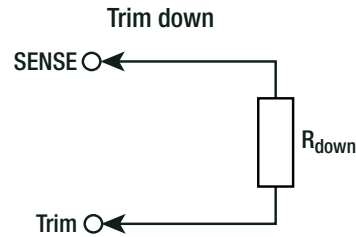
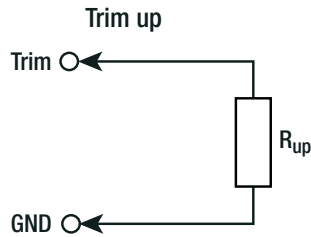

Calculation:

- V_{OUT} = nom. output voltage [VDC]
- V_{out_set} = trimmed output voltage [VDC]
- V_{ref} = reference voltage [VDC]
- R_{up} = trim up resistor [Ω]
- R_{down} = trim down resistor [Ω]
- R_1, R_2, R_3 = feedback resistors [Ω]

$$R_{up} = \frac{[(V_{set} - V_{ref})(R_2 R_3)] - [(R_1 \times V_{ref})(R_2 + R_3)]}{V_{ref}(R_1 + R_2) - R_2 \times V_{set}} = [k\Omega]$$

Practical Example RPL-5.0, trim up:

$$R_{up} = \frac{[(6 - 0.6)(6.34k \times 1k)] - [(47k \times 0.6)(6.34k + 1k)]}{[0.6 \times (47k + 6.34k)] - (6.34k \times 6)}$$

$$R_{up} = 28k7\Omega \text{ (according to E96 1\%)}$$

$V_{out_set} = 1.0VDC$

Trim up

$V_{out_set} =$	1.1	[VDC]
R_{up} (E96) \approx	294k	[Ω]

$V_{out_set} = 1.2VDC$

Trim up

$V_{out_set} =$	1.32	1.44	[VDC]
R_{up} (E96) \approx	232k	118k	[Ω]

$V_{out_set} = 1.8VDC$

Trim up

$V_{out_set} =$	1.9	2	2.16	[VDC]
R_{up} (E96) \approx	332k	150k	80k6	[Ω]

$V_{out_set} = 2.5VDC$

Trim up

$V_{out_set} =$	2.6	2.8	3	[VDC]
R_{up} (E96) \approx	232k	86k6	53k6	[Ω]

$V_{out_set} = 3.3VDC$

Trim up

$V_{out_set} =$	3.4	3.5	3.63	3.96	[VDC]
R_{up} (E96) \approx	243k	130k	80k6	41k2	[Ω]

$V_{out_set} = 5.0VDC$

Trim up

$V_{out_set} =$	5.5	6	[VDC]
R_{up} (E96) \approx	61k9	28k7	[Ω]

V_{OUT} [VDC]	R_1 [Ω]	R_2 [Ω]	R_3 [Ω]	V_{ref}
1.0	47k	69k8	1k	0.6VDC
1.2		47k		
1.8		23k2		
2.5		15k		
3.3		10k5		
5.0		6k34		

$$R_{down} = \frac{(V_{set} - V_{ref})(R_1 R_2 + R_2 R_3) - V_{ref}(R_1 R_3)}{V_{ref}(R_1 + R_2) - V_{set}(R_2)} = [k\Omega]$$

Practical Example RPL-5.0, trim down:

$$R_{down} = \frac{(4 - 0.6)[(47k \times 6.34k) + (6.34k \times 1k)] - (0.6 \times 47k \times 1k)}{[0.6 \times (47k + 6.34k)] - (4 \times 6.34k)}$$

$$R_{down} = 147k\Omega \text{ (according to E96 1\%)}$$

Trim down

$V_{out_set} =$	0.9	0.8	[VDC]
R_{down} (E96) \approx	133k	45k3	[Ω]

Trim down

$V_{out_set} =$	1.08	0.96	[VDC]
R_{down} (E96) \approx	187k	69k8	[Ω]

Trim down

$V_{out_set} =$	1.7	1.6	1.44	[VDC]
R_{down} (E96) \approx	442k	215k	105k	[Ω]

Trim down

$V_{out_set} =$	2.2	2.1	2	[VDC]
R_{down} (E96) \approx	267k	182k	137k	[Ω]

Trim down

$V_{out_set} =$	3	2.9	2.64	[VDC]
R_{down} (E96) \approx	392k	280k	147k	[Ω]

Trim down

$V_{out_set} =$	4	[VDC]
R_{down} (E96) \approx	150k	[Ω]

RPL-5.0-EVM-1 ◊ Evaluation Module

5 Amp ◊ Input: 2.75-17VDC

DIMENSION & PHYSICAL CHARACTERISTICS

Parameter	Type	Value
Dimension (LxWxH)		120.0 x 75.0 x 6.5mm
		0.86 x 0.36 x 0.44inch
Weight		46g typ. 0.10 lbs

Layout

Top Layer

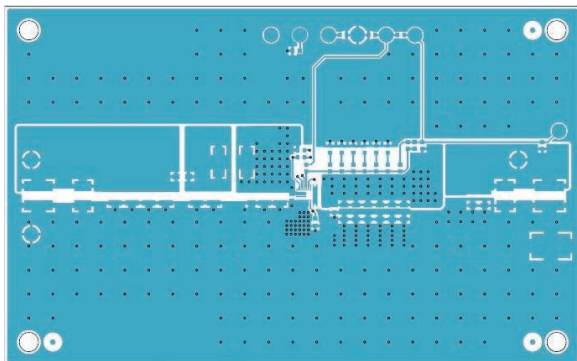

Layer 2 (GND)

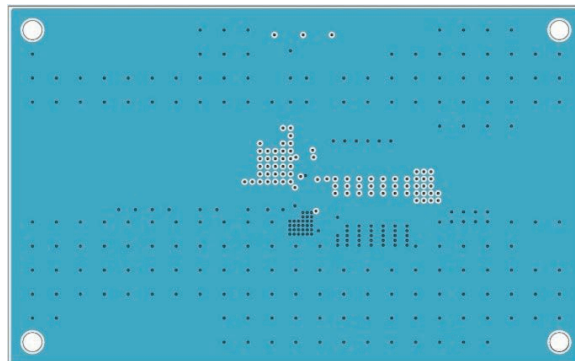

Layer 3 (Signal)

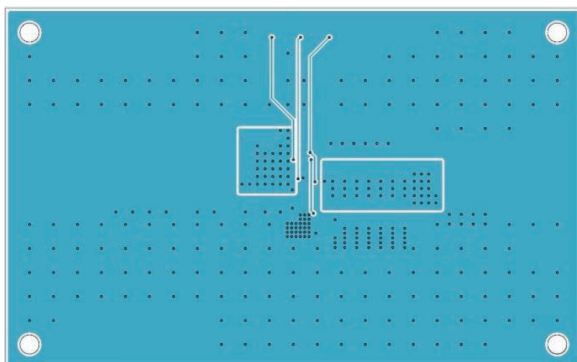

Bottom Layer

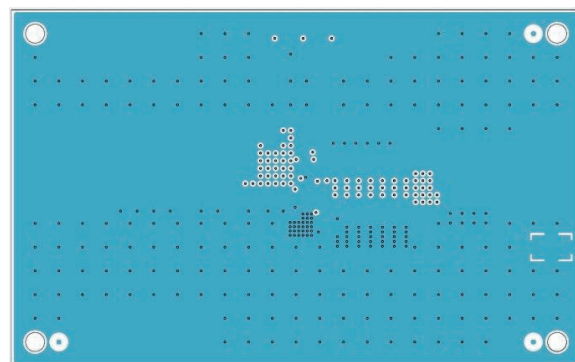

Note2: Visit www.recom-power.com/eval-ref-boards to download Gerber files

BOM

Component	Description	Manufacturer Part Number	Manufacturer	Remarks
C1-C4, C10	22µF X7R 25VDC 1210	CL32B226KAJNFNE	SAMSUNG ELECTRO-MECHANICS	
C5-C8, C13	22µF X7R 10VDC 1206	CL31B226KPHNFNE	SAMSUNG ELECTRO-MECHANICS	
C9, C14	1206			not mounted
C11, C18-C19	1210			not mounted
C15	100nF X7R 100VDC 0603	CC0603KRX7R0BB104	YAGEO	
C16	39pF C0G 50VDC 0603	0603N390J500CT	WALSIN TECHNOLOGY	
C17	1µF X7R 16VDC 0603	CL10B105K08NFNC	SAMSUNG ELECTRO-MECHANICS	
C20-C21	100nF X7R 25VDC 0603	CL10B104KA8NFNC	SAMSUNG ELECTRO-MECHANICS	
C22	10µF X7R 50VDC 1206	C3216X7R1H106K160AC	TDK	
L3	FERRITE BEAD 30 OHM 0805	742792030	WURTH	
L4, L6	FIXED IND SMT			not mounted
L5	2.2µH 10A 12MOHM SMT	LMLP07C7M2R2DTAS	KYOCERA AVX	
P1-P2	CONNECTOR	695402400222	WURTH	
R1	499K 0.1W 1% 100ppm 0603	CRCW0603499KFKEA	VISHAY	
R2	0R 0.1W 0603	RC0603JR-070RL	YAGEO	
R3	0603			not mounted

RPL-5.0-EVM-1 ◊ Evaluation Module

5 Amp ◊ Input: 2.75-17VDC



BOM				
Component	Description	Manufacturer Part Number	Manufacturer	Remarks
R4	1K 0.1W 1% 100ppm 0603	RC0603FR-071KL	YAGEO	
R5, R7	47K 0.1W 1% 100PPM 0603	RC0603FR-0747KL	YAGEO	
R6	69K8 0.1W 1% 100ppm 0603	CRCW060369K8FKEA	VISHAY	
R8	23K2 0.1W 1% 100ppm 0603	CRCW060323K2FKEA	VISHAY	
R9	15K 0.1W 1% 100ppm 0603	CRCW060315K0FKEA	VISHAY	
R10	10K5 0.1W 1% 100ppm 0603	CRCW060310K5FKEA	VISHAY	
R11	100K 0.1W 1% 100ppm 0603	RC0603FR-07100KL	YAGEO	
R12, R16-R21, R23-R26	0603			not mounted
R14	0R 0.1W 0603	RC0603JR-070RL	YAGEO	
R22	0R 0.25W 0ppm 1206	CRCW12060000Z0EAC	VISHAY	
U1	RPL-5.0 MODULE	RPL-5.0	RECOM	

PACKAGING INFORMATION		
Parameter	Type	Value
Packaging Dimension (LxWxH)	single box	205 x 135 x 43mm
Packaging Quantity		1pc

CONTENTS

- RPL-5.0-EVM-1 Evaluation Module
- Terms and conditions

The product information and specifications may be subject to changes even without prior written notice. The product has been designed for various applications; its suitability lies in the responsibility of each customer. The products are not authorized for use in safety-critical applications without RECOM's explicit written consent. A safety-critical application is an application where a failure may reasonably be expected to endanger or cause loss of life, inflict bodily harm or damage property. The applicant shall indemnify and hold harmless RECOM, its affiliated companies and its representatives against any damage claims in connection with the unauthorized use of RECOM products in such safety-critical applications.

X-ON Electronics

Largest Supplier of Electrical and Electronic Components

Click to view similar products for [Power Management IC Development Tools](#) category:

Click to view products by [RECOM POWER](#) manufacturer:

Other Similar products are found below :

[EVB-EP5348UI](#) [BQ25010EVM](#) [ISL80019AEVAL1Z](#) [ISLUSBI2CKIT1Z](#) [ISL8002AEVAL1Z](#) [ISL91108IIA-EVZ](#) [MAX8556EVKIT](#)
[MAX15005AEVKIT+](#) [ISL28022EVKIT1Z](#) [STEVAL-ISA008V1](#) [DRI0043](#) [KITPF8100FRDMEVM](#) [EVB-EN6337QA](#)
[SAMPLEBOXILD8150TOBO1](#) [MAX18066EVKIT#](#) [AP62300WU-EVM](#) [KITA2GTC387MOTORCTRTOBO1](#) [AEK-MOT-TK200G1](#)
[EVLONE65W](#) [STEVAL-ILH006V1](#) [STEVAL-IPE008V2](#) [STEVAL-IPP001V2](#) [STEVAL-ISA013V1](#) [STEVAL-ISA067V1](#) [STEVAL-](#)
[ISQ002V1](#) [TPS2306EVM-001](#) [TPS2330EVM-185](#) [TPS40001EVM-001](#) [SECO-HVDCDC1362-15W-GEVB](#) [BTS7030-2EPA](#)
[LT8638SJV#WPBF](#) [LTC3308AIV#WTRPBF](#) [TLT807B0EPV](#) [BTS71033-6ESA](#) [EV13N91A](#) [EASYPIC V8 OVER USB-C](#) [EV55W64A](#)
[CLICKER 4 FOR STM32F4](#) [EASYMX PRO V7A FOR STM32](#) [CLICKER 4 FOR PIC18F](#) [Si8285_86v2-KIT](#) [PAC52700EVK1](#) [NCP-](#)
[NCV51752D2PAK3LGEVB](#) [ISL81807EVAL1Z](#) [AP33772S-EVB](#) [EVALM7HVIGBTFCINV4TOBO1](#) [903-0300-000](#) [902-0173-000](#) [903-](#)
[0301-000](#) [ROA1286023/1](#)