

# Features

## ICE Technology\*

- +115°C Maximum Case Temperature
- -45°C Minimum Case Temperature
- Built-in EMC Filter
- Ribbed Case Style
- 2250VDC Isolation
- EN-55022 Class B

### Description

The RPP20 series 2:1 input range DC/DC converters are ideal for high end industrial applications and COTS Military applications where a very wide operating temperature range of -45°C to +115°C is required. Although the case size is very compact, the converter contains a built-in EMC filter EN-55022 Class B without the need for any external components. The RPP20 is available in a ribbed case style for active cooling. They are UL-60950-1 certified.

### Selection Guide

Part Number	Input Voltage Range [VDC]	Input Current [mA]	Output Voltage [VDC]	Output Current [mA]	Efficiency typ. [%]	Max. Capacitive Load [ $\mu$ F]
RPP20-2424D	18-36	940	$\pm$ 24	$\pm$ 420	90	$\pm$ 220

#### Notes:

Note1: Typical values at nominal input voltage and full load.

### Specifications (measured @ $t_a = 25^\circ\text{C}$ , nominal input voltage, full load and after warm-up)

BASIC CHARACTERISTICS					
Parameter	Condition	Min.	Typ.	Max.	
Input Voltage Range	nom. $V_{in} = 24\text{VDC}$	18VDC	24VDC	36VDC	
Transient Input Voltage	$\leq 100\text{ms}$			50VDC	
Inrush Current	with EMC Filter without EMC Filter			20A 40A	
Under Voltage Lockout	DC-DC ON DC-DC OFF	17.5VDC		17VDC	
Remote ON/OFF	ON / high logic OFF / low logic	Open, 4.5V Short, 0V		5.5V 1.2V	
Remote OFF Input Voltage	nominal input		5mA		
Start-up Time	when use CTRL function		20ms		
Internal Operating Frequency		270kHz	300kHz	330kHz	
Efficiency	typ. $V_{in}$ , full load	89%	90%		
Minimum Load		10%			
Output Ripple and Noise	20MHz limited, 1 $\mu$ F output MLCC		240mVp-p	360mVp-p	

Efficiency vs. Load

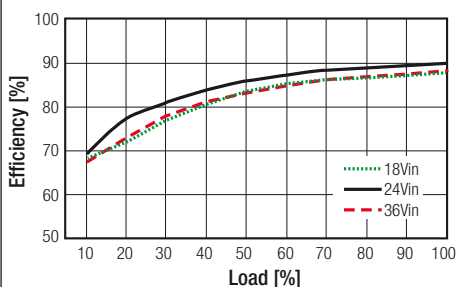

Efficiency vs. Input Voltage

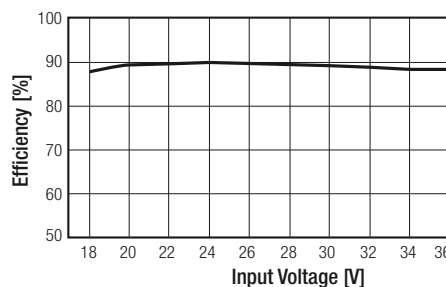

**RECOM**  
DC/DC Converter

## RPP20-2424D

20 Watt 2:1

1.6" x 1"

Ribbed Style  
Dual Output



UL US  
E224736

UL-60950-1 Certified  
EN-55022 Certified

#### \* ICE Technology

ICE (Innovation in Converter Excellence) uses state-of-the-art techniques to minimise internal power dissipation and to increase the internal temperature limits to extend the ambient operating temperature range to the maximum.

**Specifications** (measured @  $t_a = 25^\circ\text{C}$ , nominal input voltage, full load and after warm-up)

REGULATIONS		
Parameter	Condition	Value
Output Voltage Accuracy	50% load	$\pm 1.5\%$ max.
Line Voltage Regulation	low line to high line	$\pm 0.3\%$ max.
Load Voltage Regulation	10% to 100% load	$\pm 0.5\%$ max.
Cross Regulation	10% to 100% load	3% typ. / 5% max.
Transient Response	25% load step change, $\Delta I_o / \Delta t = 2.5\text{A}/\mu\text{s}$	800 $\mu\text{s}$ typ.
Transient Peak Deviation	25% load step change, $\Delta I_o / \Delta t = 2.5\text{A}/\mu\text{s}$	$\pm 2\%$ $V_{out}$ max.

PROTECTIONS		
Parameter	Condition	Value
Output Power Protection (OPP)	current limit	120% typ.
Over Voltage Protection (OVP)	10% load	120% typ.
Over Temperature Protection (OTP)	case temperature	120 $^\circ\text{C}$ , auto-recovery
Isolation Voltage	I/P to O/P, at 70% RH I/P to Case, O/P to Case	2250VDC / 1 Minute 1500VDC / 1 Minute
Isolation Resistance	I/P to O/P, at 70% RH	100M $\Omega$ min.
Isolation Capacitance	I/P to O/P	1500pF typ.

**Notes:**

Note3: This Power Module is not internally fused. A input fuse must be always used. Recommended Fuse: T2.5A

ENVIRONMENTAL		
Parameter	Condition	Value
Relative Humidity		95%, non condensing
Temperature Coefficient		$\pm 0.04\%$ / $^\circ\text{C}$ max.
Thermal Impedance	natural convection, mounting at FR4 (254x254mm) PCB vertical horizontal	7.2 $^\circ\text{C}/\text{W}$ 7.8 $^\circ\text{C}/\text{W}$
Operating Temperature Range	start up at -45 $^\circ\text{C}$	-45 $^\circ\text{C}$ to (see calculation)
Maximum Case Temperature		+115 $^\circ\text{C}$
MTBF	according to MIL-HDBK-217F (+50 $^\circ\text{C}$ G.B.) according to BellCore-TR-332 (+50 $^\circ\text{C}$ G.B.)	768 x 10 <sup>3</sup> hours 1572 x 10 <sup>3</sup> hours

**Derating Graph**

( $T_a = +25^\circ\text{C}$ , natural convection, vertical mounting)

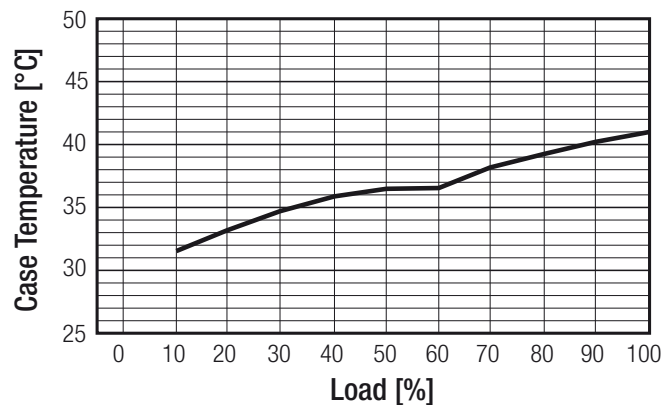

continued on next page

**Specifications (measured @ ta= 25°C, nominal input voltage, full load and after warm-up)**

**Calculation**

$R_{th\text{case-ambient}} = 7.2^{\circ}\text{C/W}$  (vertical)  
 $R_{th\text{case-ambient}} = 7.8^{\circ}\text{C/W}$  (horizontal)

$R_{th\text{case-ambient}} = \frac{T_{\text{case}} - T_{\text{ambient}}}{P_{\text{dissipation}}}$

$P_{\text{dissipation}} = P_{\text{IN}} - P_{\text{OUT}} = \frac{P_{\text{OUTapp}}}{\eta} - P_{\text{OUTapp}}$

- $T_{\text{case}}$  = Case Temperature
- $T_{\text{ambient}}$  = Environment Temperature
- $P_{\text{dissipation}}$  = Internal losses
- $P_{\text{IN}}$  = Input Power
- $P_{\text{OUT}}$  = Output Power
- $\eta$  = Efficiency under given Operating Conditions
- $R_{th\text{case-ambient}}$  = Thermal Impedance

**Practical Example:**

Take the RPP20-2424D with 50% load. What is the maximum ambient operating temperature? Use converter vertical in application.

$Eff_{\text{min}} = 89\% @ V_{\text{nom}}$   
 $P_{\text{OUT}} = 20\text{W}$   
 $P_{\text{OUTapp}} = 20 \times 0.5 = 10\text{W}$

$P_{\text{dissipation}} = \frac{P_{\text{OUTapp}}}{\eta} - P_{\text{OUTapp}}$

$\eta = \sim 85\%$  (from Eff vs Load Graph)

$P_{\text{dissipation}} = \frac{10}{0.86} - 10 = 1.63\text{W}$

$R_{th} = \frac{T_{\text{casemax}} - T_{\text{ambient}}}{P_{\text{dissipation}}} \rightarrow 7.2^{\circ}\text{C/W} = \frac{115^{\circ}\text{C} - T_{\text{ambient}}}{1.63\text{W}}$

$T_{\text{ambientmax}} = \underline{\underline{103.3^{\circ}\text{C}}}$

**Soldering**

**Hand Soldering**

Hand Soldering is the least preferred method because the amount of solder applied, the time the soldering iron is held on the joint, the temperature of the iron and the temperature of the solder joint are variable.

The recommended hand soldering guideline is listed in Table 1. The suggested soldering process must keep the power module's internal temperature below the critical temperature of 217°C continuously.

**Wave Soldering**

High temperature and long soldering time will result in IMC layer increasing in thickness and thereby shorten the solder joint lifetime. Therefore the peak temperature over 245°C is not suggested due to the potential reliability risk of components under continuous high-temperature. In the meanwhile, the soldering time of temperature above 217°C should be less than 90 seconds. Please refer to the soldering profile below for recommended temperature profile parameters.

Table 1 Hand-Soldering Guideline			
Parameter	Single-side Circuit Board	Double-side Circuit Board	Multi-layers Circuit Board
Soldering Iron Wattage	90W	90W	90W
Tip Temperature	385 ±10°C	420 ±10°C	420 ±10°C
Soldering Time	2-6 seconds	4-10 seconds	4-10 seconds

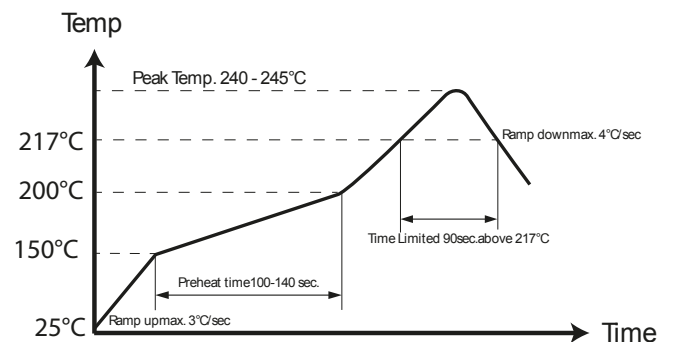

Specifications (measured @  $t_a = 25^\circ\text{C}$ , nominal input voltage, full load and after warm-up)

SAFETY AND CERTIFICATIONS		
Certificate Type (Safety)	Report Number	Standard
Information Technology Equipment, General Requirements for Safety	E224236	UL-60950-1, 1st Edition
Certificate Type (Environmental)	Condition	Standard / Criterion
Information technology equipment - Radio disturbance characteristics - Limits and methods of measurement		EN55022, Class B
ESD Immunity Test	$\pm 8\text{kV}$ Air Discharge, $\pm 6\text{kV}$ Contact Discharge	IEC61000-4-2, Criteria B
RF Field Strength Susceptibility Test	10V/m	IEC61000-4-3, Criteria A
Electrical Fast Transient Test / Burst Immunity Text	$\pm 4\text{kV}$ Applied	IEC61000-4-4, Criteria B
Surge Immunity Test	$\pm 4\text{kV}$ Applied	IEC61000-4-5, Criteria B
Conducted Disturbance Susceptibility Test	10V rms	IEC61000-4-6, Criteria A
Vibration	50-150Hz, along X, Y and Z	EN60068-2-6
Thermal Cycling (complies with MIL-STD-810F)	12 cycles	EN60068-2-14
Shock	5g / 30ms	EN60068-2-27

### EMC Filtering - Suggestions

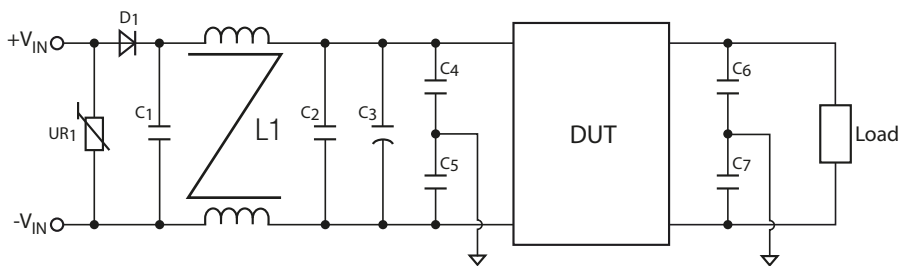

It is recommended to add UR1, D1 and C1 in railway application. C1, L1, C2 and C3 can be modified for required EMI standards. To meet EN61000-4-2, module case should be earth grounded. We offer independent case pin option on request.

Standard	UR1	D1	C1	L1	C2	C3	C4, C5, C6, C7
EN55022 Class B	MOV 14D361K	50V / 9A	1.5 $\mu\text{F}$ / 250V	550 $\mu\text{H}$ $\pm 20\%$	6.8 $\mu\text{F}$ / 50V	330 $\mu\text{F}$ / 50V	0.47nF Y1-Cap
EN61000-4-2, 3, 4, 5, 6			N/A	N/A	N/A		

DIMENSION AND PHYSICAL CHARACTERISTICS	
Parameter	Value
Material <sup>(5)</sup>	Aluminium
Package Dimension (LxWxH)	40.6 x 25.4 x 12.7mm
Package Weight	27g

continued on next page

Specifications (measured @  $t_a = 25^\circ\text{C}$ , nominal input voltage, full load and after warm-up)

### Dimension Drawing (mm)

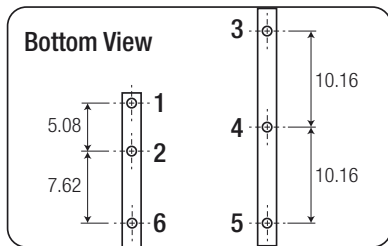
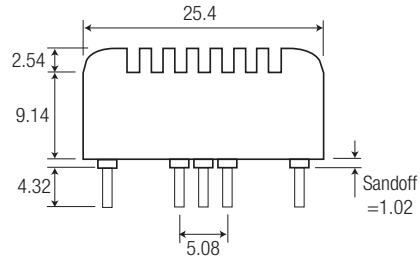
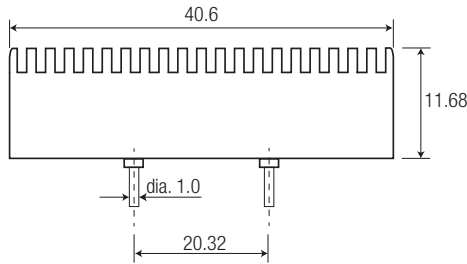

### Pin Connections

Pin #	Dual
1	+Vin
2	-Vin
3	+Vout
4	Com
5	-Vout
6	CTRL

Tolerance:  $\pm 0.8\text{mm}$

### Notes:

Note5: To ensure a good all-round electrical contact, the bottom plate is pressed firmly into place into the aluminium case. The hydraulic press can leave tooling marks and deformations to both the case and plate. The case is anodised aluminium, so there will be natural variations in the case colour and the aluminium is not scratch resistant. Any resultant marks, scratches and colour variations are cosmetic only and do not affect the operation or performance of the converters.

## INSTALLATION and APPLICATION

### Test Set-up

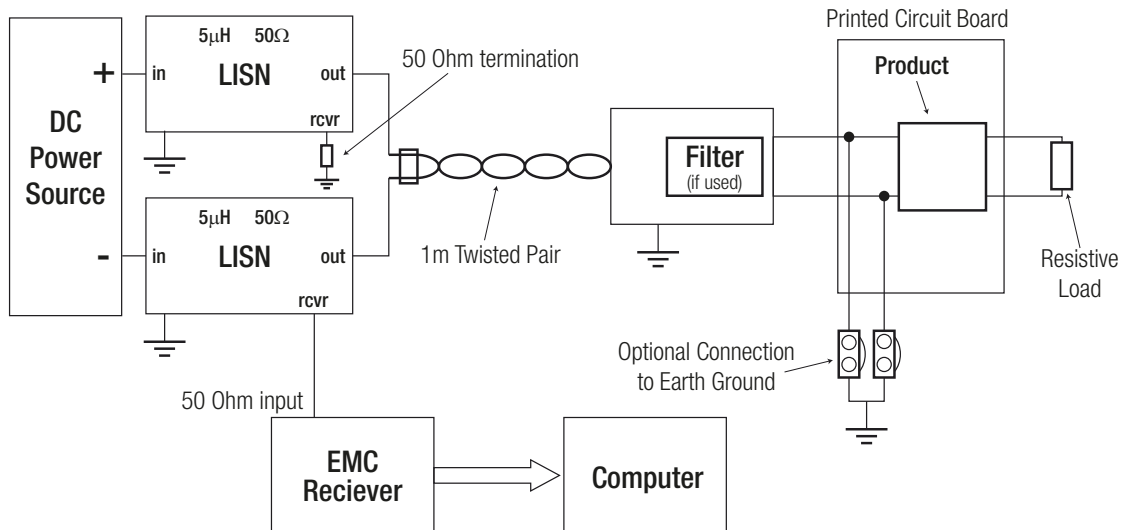

## PACKAGING INFORMATION

Parameter	Type	Value
Packaging Dimension (LxWxH)	Tube	160.0 x 45.0 x 16.0mm
Packaging Quantity		5pcs
Storage Temperature Range		-55°C to +125°C

The product information and specifications may be subject to changes even without prior written notice. The product has been designed for various applications; its suitability lies in the responsibility of each customer. The products are not authorized for use in safety-critical applications without RECOM's explicit written consent. A safety-critical application is an application where a failure may reasonably be expected to endanger or cause loss of life, inflict bodily harm or damage property. The applicant shall indemnify and hold harmless RECOM, its affiliated companies and its representatives against any damage claims in connection with the unauthorized use of RECOM products in such safety-critical applications.

## X-ON Electronics

Largest Supplier of Electrical and Electronic Components

*Click to view similar products for [Isolated DC/DC Converters](#) category:*

*Click to view products by [RECOM POWER](#) manufacturer:*

Other Similar products are found below :

[ESM6D044440C05AAQ](#) [FMD15.24G](#) [PSL486-7LR](#) [Q48T30020-NBB0](#) [JAHW100Y1](#) [SPB05C-12](#) [SQ24S15033-PS0S](#) [18952](#) [19-130041](#)  
[CE-1003](#) [CE-1004](#) [GQ2541-7R](#) [RDS180245](#) [MAU228](#) [J80-0041NL](#) [DFC15U48D15](#) [XGS-0512](#) [XGS-1205](#) [XGS-1212](#) [XGS-2412](#) [XGS-](#)  
[2415](#) [XKS-1215](#) [06322](#) [NCT1000N040R050B](#) [SPB05B-15](#) [SPB05C-15](#) [L-DA20](#) [DCG40-5G](#) [QME48T40033-PGB0](#) [XKS-2415](#) [XKS-2412](#)  
[XKS-1212](#) [XKS-1205](#) [XKS-0515](#) [XKS-0505](#) [XGS-2405](#) [XGS-1215](#) [XGS-0515](#) [PS9Z-6RM4](#) [73-551-5038I](#) [AK1601-9RT](#) [VI-N61-CM](#) [VI-](#)  
[R5022-EXWW](#) [PSC128-7iR](#) [RPS8-350ATX-XE](#) [DAS1004812](#) [VI-LJ11-iz](#) [PQA30-D24-S24-DH](#) [VI-M5F-CQ](#) [VI-LN2-EW](#)