

Features

Power Module

- AEC-Q100 qualified buck regulator power module with integrated shielded inductor
- 36VDC input voltage, 0.5A output current
- SCP, OCP, OTP, and UVLO protection
- 3.0 x 5.0mm low profile QFN package with wettable flanks for optical inspection
- Enable, power good, soft start, and sync functions
- -40 to 125°C operating temperature

RPX-0.5Q

0.5 Amp QFN Package



Description

The RPX-0.5Q is an automotive-grade buck converter with an integrated inductor in a compact 3mm x 5mm x 1.6mm thermally-enhanced QFN package with wettable flanks. The input range is from 4 to 36VDC, allowing 5V, 12V, or 24V supply voltages to be used. The output voltage can be set with two resistors in the range from 0.8 up to 34VDC. The output current is up to 0.5A and is fully protected against continuous short-circuits, output overcurrent, or over-temperature faults.

Selection Guide

Part Number	Input Voltage Range [VDC]	Output Voltage ⁽¹⁾ [VDC]	Output Current [mA]	Efficiency typ. ⁽²⁾ [%]
RPX-0.5Q	4 - 36	0.8 - 34	500	90

Notes:

Note1: Refer to **“SAFE OPERATING AREA”**

Note2: Efficiency tested at $V_{IN}= 12VDC$, full load, and $V_{OUT}= 3.3VDC$

Model Numbering

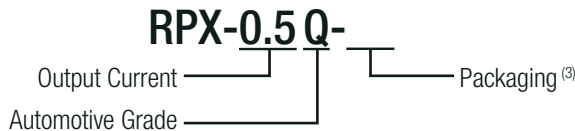

Notes:

Note3: Add suffix **“-R”** for tape and reel packaging

Add suffix **“-CT”** for bag packaging (refer to **“PACKAGING INFORMATION”**)

Specifications

ABSOLUTE MAXIMUM RATINGS (exceeding these ratings may damage the device)

Parameter	Symbol	Min.	Typ.	Max.
Absolute Maximum Voltage	V_{IN}	-0.3VDC		40VDC
	V_{SW}	-0.3VDC		$V_{IN} + 0.3VDC$
	V_{OUT}	-0.3VDC		$V_{IN} + 0.3VDC$
	V_{BST}			$V_{SW} + 6VDC$
	others	-0.3VDC		6VDC
Maximum Continuous Power Losses ⁽⁴⁾	@ $T_{AMB} = 25^{\circ}C$			3.9W
Junction Temperature	T_J			150°C
Lead Temperature				260°C
Storage Temperature		-65°C		+150°C

Notes:

Note4: Maximum power losses = $(150-T_{amb})/46$. Exceeding this value will activate thermal protection.



<https://www.recom-power.com/pdf/Eval-Boards/RPX-0.5Q-Q-EVM-1.pdf>

Specifications

OPERATING CONDITIONS ($V_{IN}= 12VDC$, $T_J= -40^{\circ}C$ to $+125^{\circ}C$, unless otherwise noted, typical values are at $T_J= +25^{\circ}C$)

Parameter	Condition	Min.	Typ.	Max.
Input Voltage Range		4VDC		36VDC
V_{IN} Under-voltage Lockout Threshold	DC-DC ON	3VDC	3.5VDC	3.8VDC
	DC-DC OFF		3.17VDC	
V_{IN} Under-voltage Lockout Threshold Hysteresis			330mV	
Output Voltage Range	refer to "SAFE OPERATING AREA"	0.8VDC		34VDC
Standby Current	DC-DC OFF			8 μ A
Quiescent Current			0.7mA	1mA
Switching Frequency		300kHz	400kHz	500kHz
Feedback Voltage	$T_{AMB} = 25^{\circ}C$ $T_{AMB} = -40^{\circ}C$ to $+125^{\circ}C$	795mV 790mV	807mV	819mV 824mV
Feedback Current	$V_{FB}= 820mV$		10nA	50nA
Rise-time	internal soft start	0.4ms	1.7ms	3ms

Typical Application

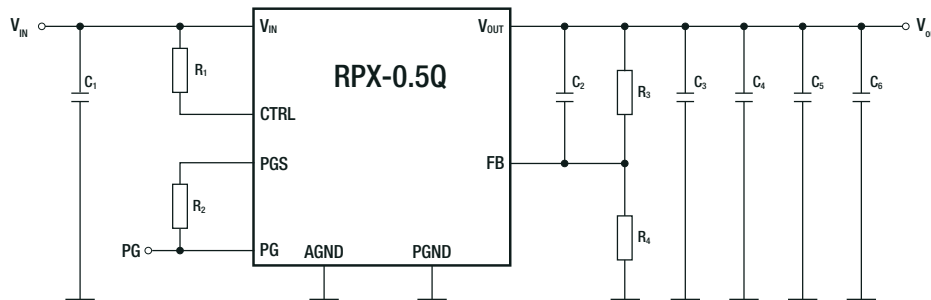

C1 (C_{IN})	R1	R2	C2 (C_{FF}) ⁽⁵⁾	R3	R4	C3 - C6 (C_{OUT})
10 μ F	100k Ω	100k Ω	$V_{out} < 2VDC$, 22pF	75k Ω	Refer to "OUTPUT VOLTAGE TRIMMING"	10 μ F

Notes:

Note5: C_2 (C_{FF}) is required for low output voltages (<2VDC)

The typical performance and circuit waveforms are shown in the Typical Performance Characteristics section.

For more device applications, please refer to the related evaluation board datasheet [RPX-0.5QQ-EVM-1](#)

SAFE OPERATING AREA

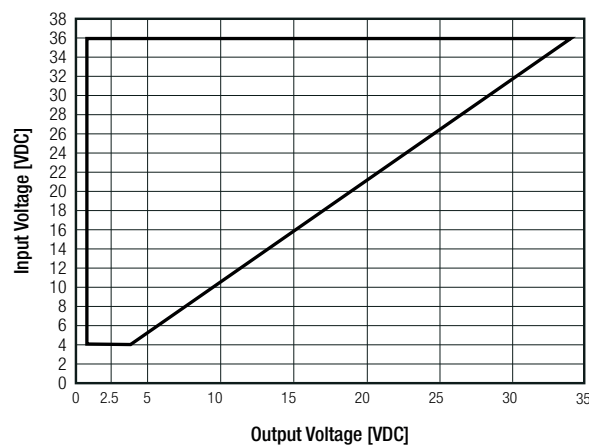

POWER GOOD OPERATING CONDITIONS ($V_{IN}= 12VDC$, $T_J= -40^{\circ}C$ to $+125^{\circ}C$, unless otherwise noted, typical values are at $T_J= +25^{\circ}C$)

Parameter	Condition	Min.	Typ.	Max.
Rising Threshold		0.83 V_{FB}	0.88 V_{FB}	0.93 V_{FB}
Falling Threshold		0.78 V_{FB}	0.83 V_{FB}	0.88 V_{FB}

Specifications

CTRL AND SYNC OPERATING CONDITIONS ($V_{IN}= 12VDC$, $T_J= -40^{\circ}C$ to $+125^{\circ}C$, unless otherwise noted, typical values are at $T_J= +25^{\circ}C$)

Parameter	Condition	Min.	Typ.	Max.
CTRL Rising Threshold		1.2VDC	1.45VDC	1.7VDC
CTRL Falling Threshold		0.8VDC	1VDC	1.3VDC
CTRL Input Current	$V_{CTRL}= 2VDC$		5 μ A	10 μ A
CTRL Turn-off Delay			3 μ s	
CTRL Frequency Range		410kHz		2200kHz

THERMAL OPERATING CONDITIONS ($V_{IN}= 12VDC$, $T_J= -40^{\circ}C$ to $+125^{\circ}C$, unless otherwise noted, typical values are at $T_J= +25^{\circ}C$)

Parameter	Condition	Min.	Typ.	Max.
Operating Junction Temperature		-40 $^{\circ}C$		+125 $^{\circ}C$
Thermal Impedance	case to ambient		46K/W	
	junction to case (refer to tc point)		10K/W	
Thermal Shutdown	Junction Temperature= 170 $^{\circ}C$			auto recovery after cool down

Notes:

Note6: Tested with RECOM evaluation module: [RPX-0.5QQ-EVM-1](#)

OUTPUT VOLTAGE TRIMMING

The external resistor divider sets the output voltage (see **“Typical Application”**). The feedback resistor (R_4) sets the feedback loop bandwidth with the internal compensation capacitor. R_3 should be approximately 75k Ω when $V_{OUT} \geq 1V$. The values for trim resistors shown in trim tables below are according to standard E96 values; therefore, the specified voltage may slightly vary. R_4 can then be calculated with below equation:

Calculation:

$$R_4 = \frac{R_3}{\frac{V_{OUT}}{0.807V} - 1}$$

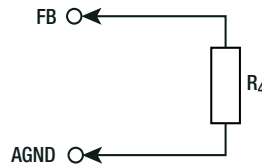

Example:

$$R_4 = \frac{75k}{\frac{1.5V}{0.807V} - 1} = 87k33$$

R_4 according to E96 \approx **86k6**

V_{OUT}	1.5	1.8	2.5	3.3	5	12	24	[VDC]
R_4 (E96) \approx	86k6	60k4	35k7	24k3	14k3	5k36	2k61	[Ω]

TYPICAL PERFORMANCE CHARACTERISTICS ($V_{OUT}= 0.8VDC$, $T_J= +25^{\circ}C$; tested with RECOM evaluation module: RPX-0.5Q-EVM-1)

Efficiency vs. Output current

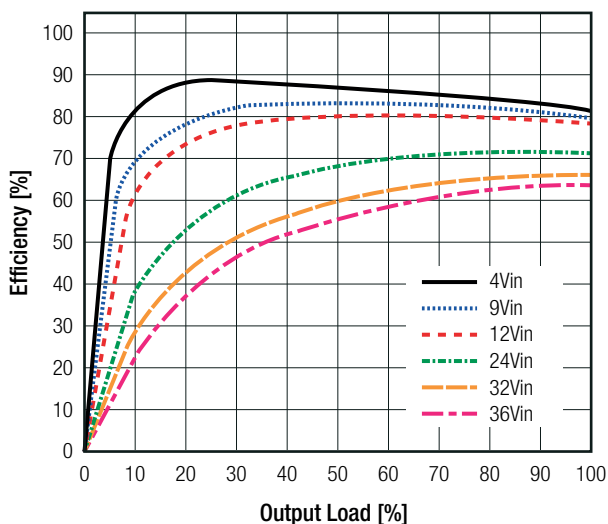

Thermal Derating

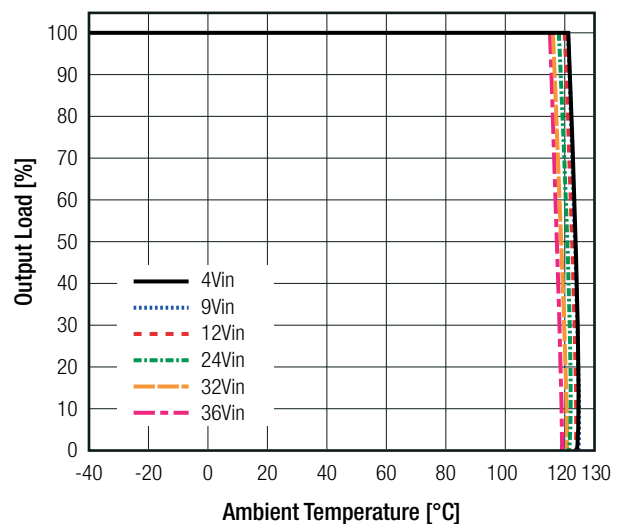

continued on next page

Specifications

TYPICAL PERFORMANCE CHARACTERISTICS ($V_{OUT} = 0.8VDC$, $T_J = +25^\circ C$; tested with RECOM evaluation module: RPX-0.5Q-EVM-1)

Deviation vs. Load

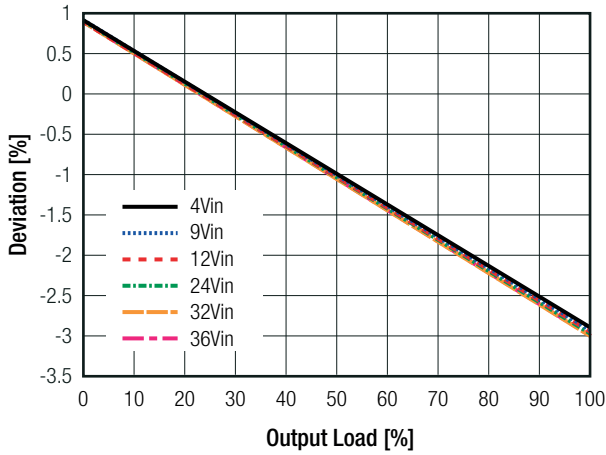

Power Dissipation

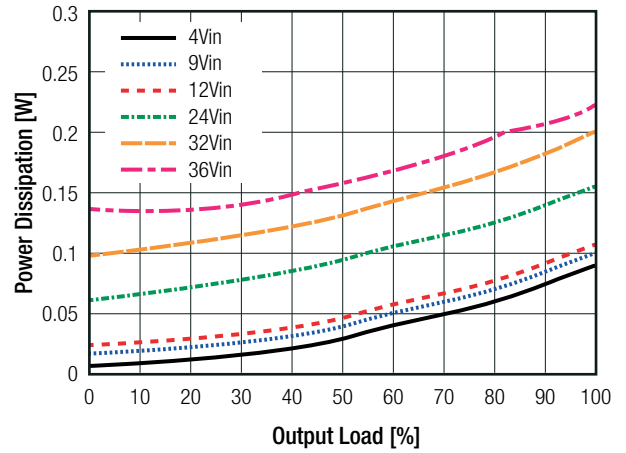

TYPICAL PERFORMANCE CHARACTERISTICS ($V_{OUT} = 1.8VDC$, $T_J = +25^\circ C$; tested with RECOM evaluation module: RPX-0.5Q-EVM-1)

Efficiency vs. Output current

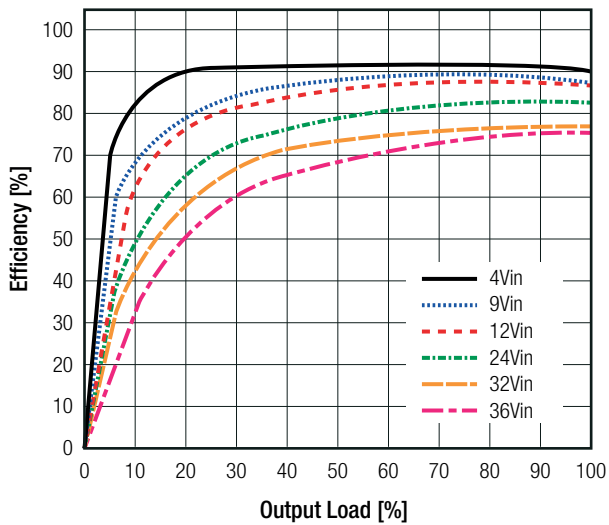

Thermal Derating

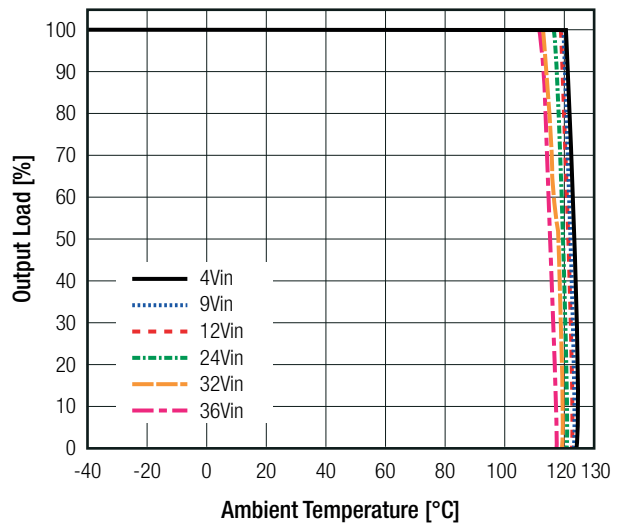

Deviation vs. Load

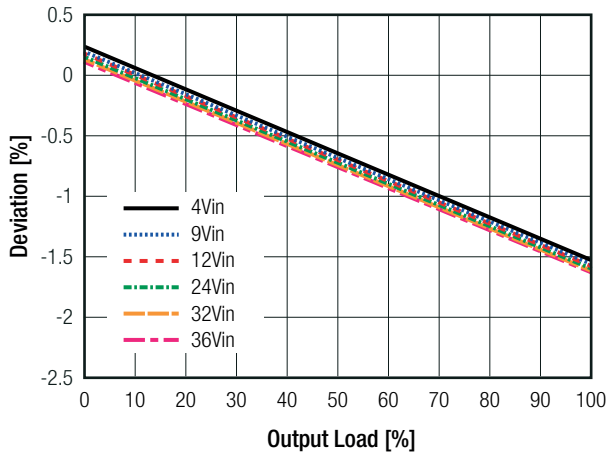

Power Dissipation

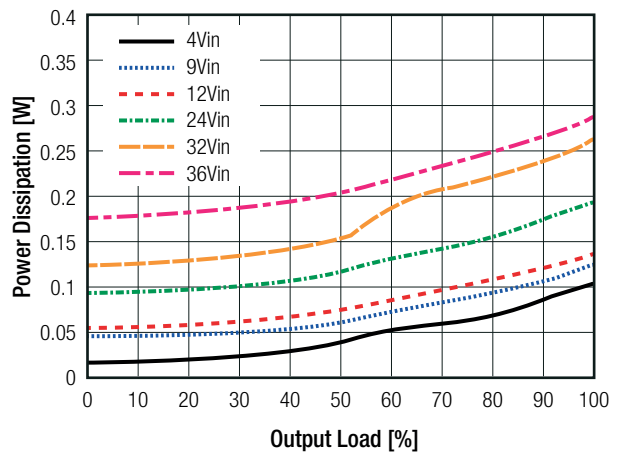

Specifications

TYPICAL PERFORMANCE CHARACTERISTICS ($V_{OUT} = 3.3VDC$, $T_J = +25^\circ C$; tested with RECOM evaluation module: RPX-0.5Q-EVM-1)

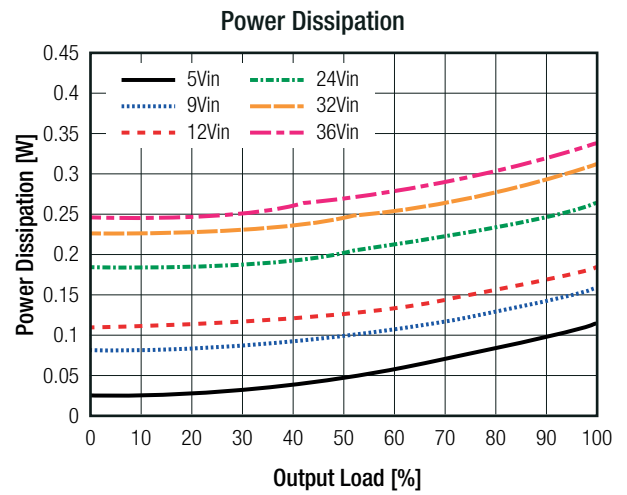
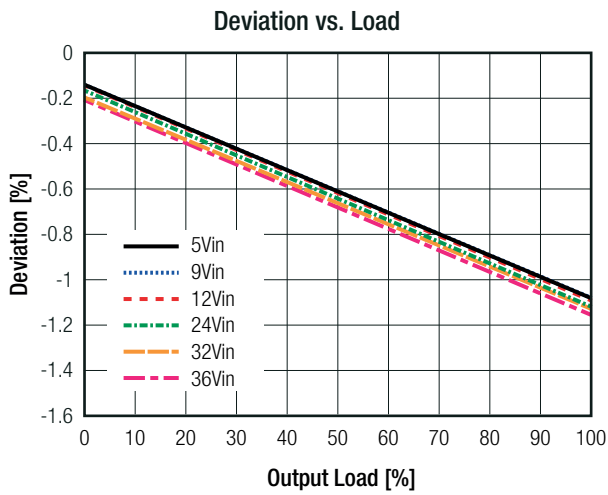
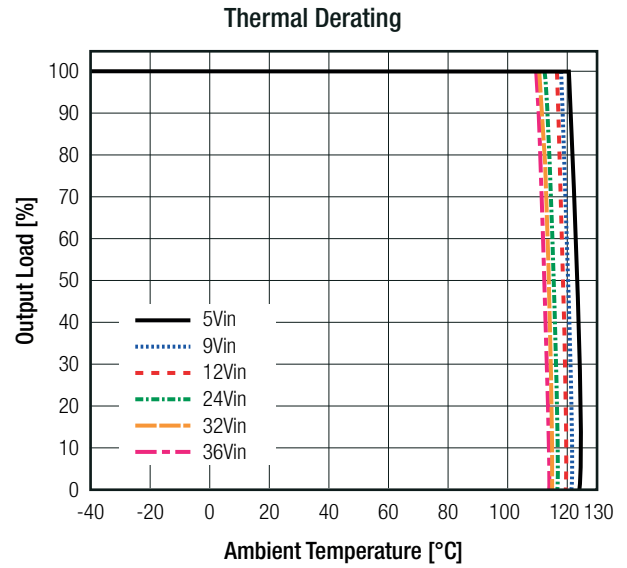
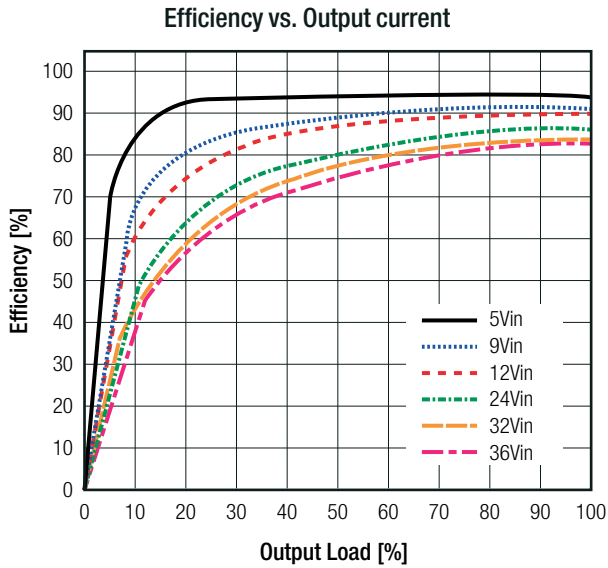

TYPICAL PERFORMANCE CHARACTERISTICS ($V_{OUT} = 5VDC$, $T_J = +25^\circ C$; tested with RECOM evaluation module: RPX-0.5Q-EVM-1)

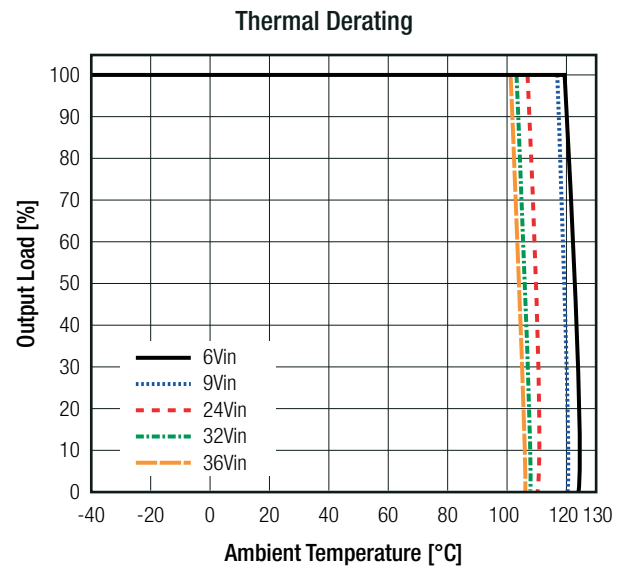
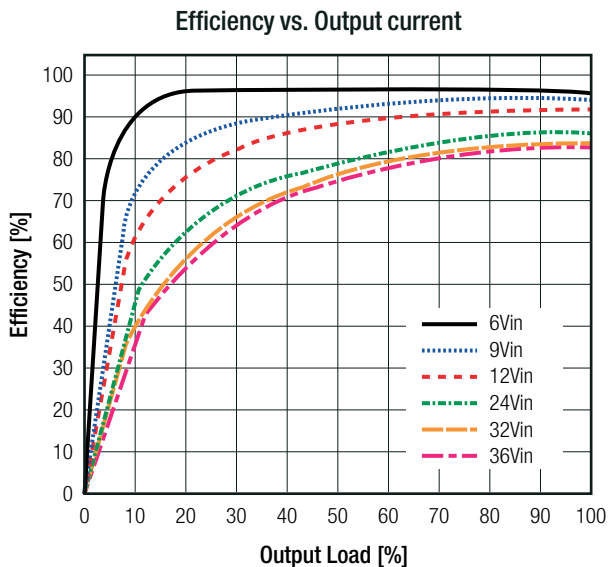

continued on next page

Specifications

TYPICAL PERFORMANCE CHARACTERISTICS ($V_{OUT} = 5VDC$, $T_J = +25^\circ C$; tested with RECOM evaluation module: RPX-0.5Q-EVM-1)

Deviation vs. Load

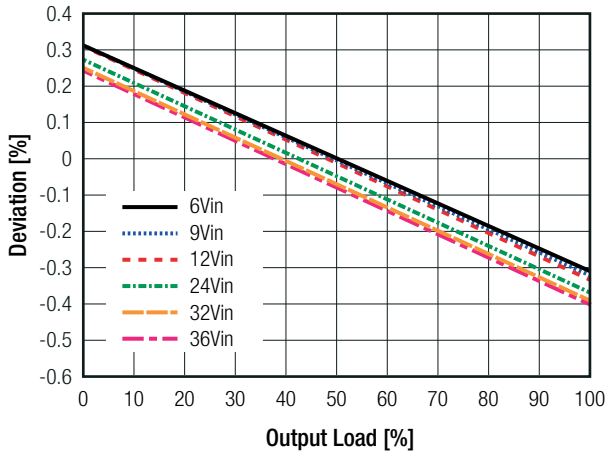

Power Dissipation

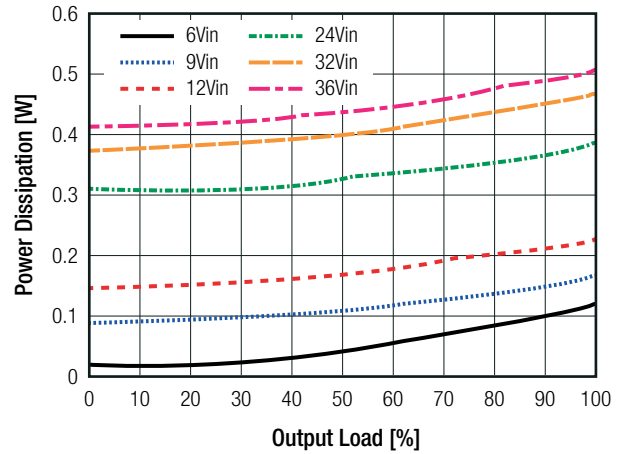

TYPICAL PERFORMANCE CHARACTERISTICS ($V_{OUT} = 12VDC$, $T_J = +25^\circ C$; tested with RECOM evaluation module: RPX-0.5Q-EVM-1)

Efficiency vs. Output current

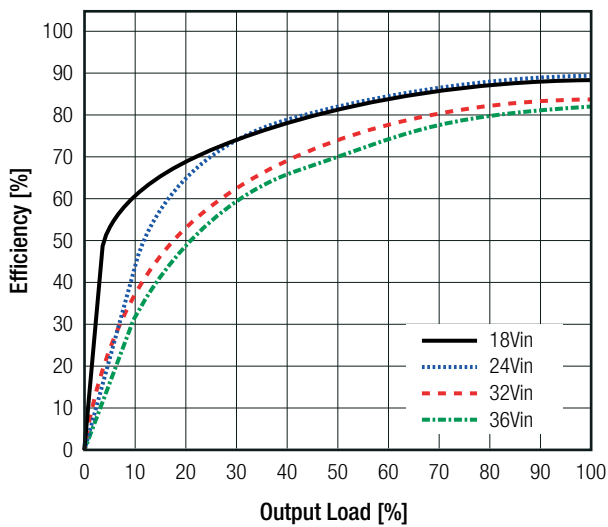

Thermal Derating

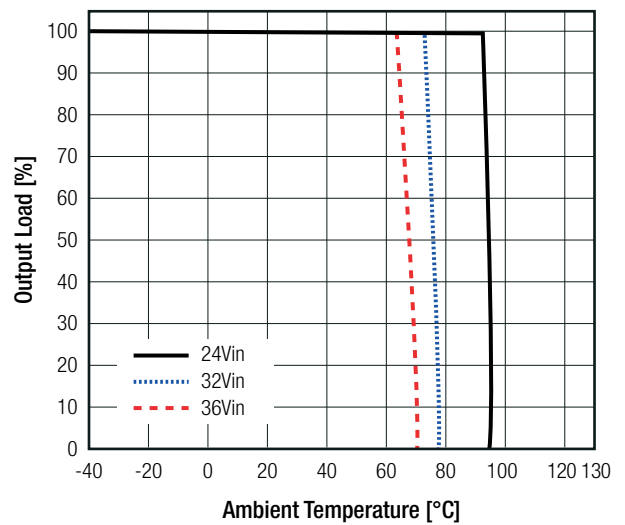

Deviation vs. Load

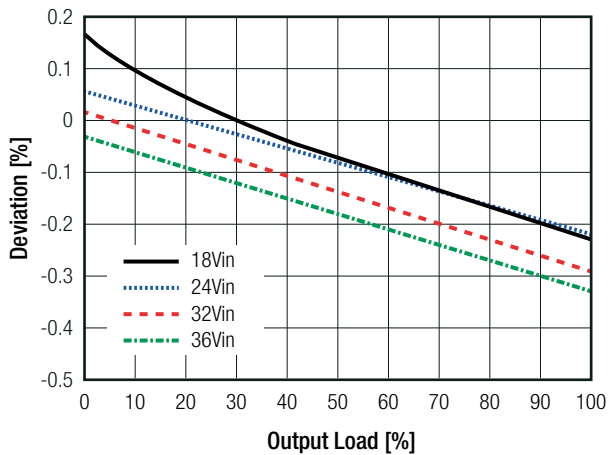

Power Dissipation

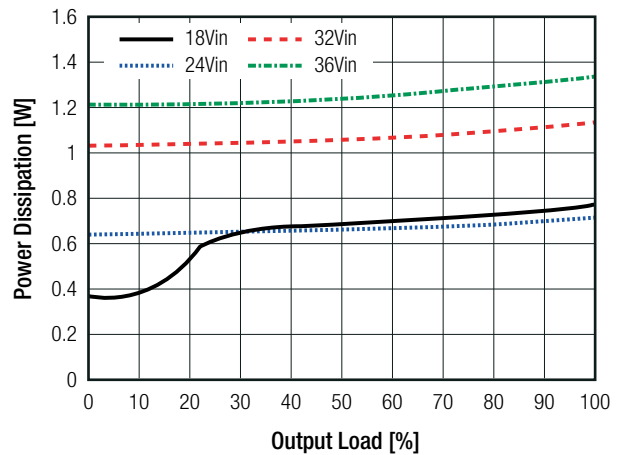

Specifications

TYPICAL PERFORMANCE CHARACTERISTICS ($V_{OUT}= 15VDC$, $T_J= +25^{\circ}C$; tested with RECOM evaluation module: RPX-0.5Q-EVM-1)

Efficiency vs. Output current

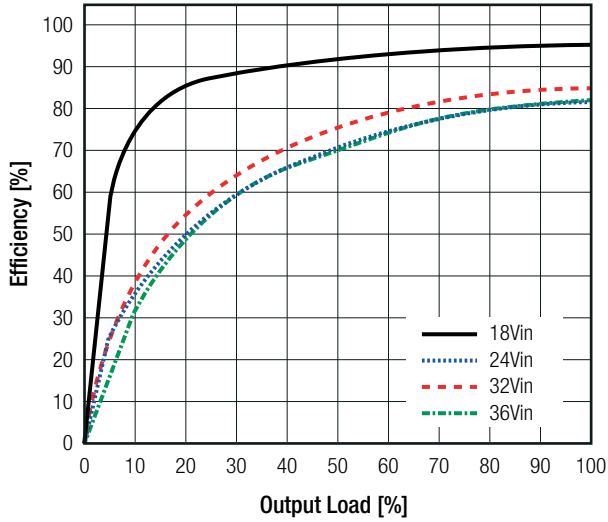

Thermal Derating

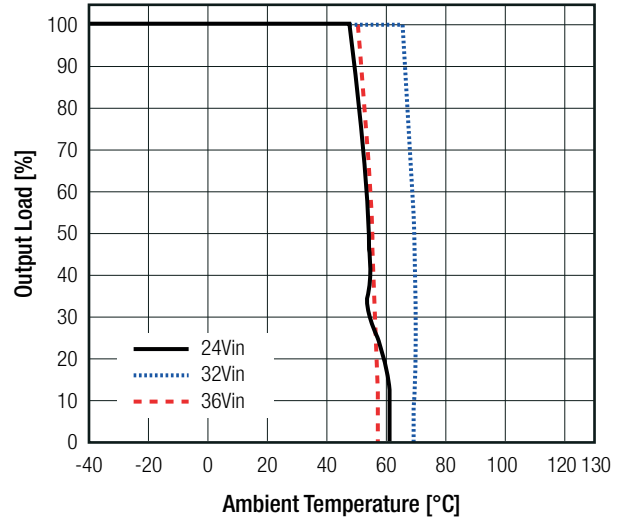

Deviation vs. Load

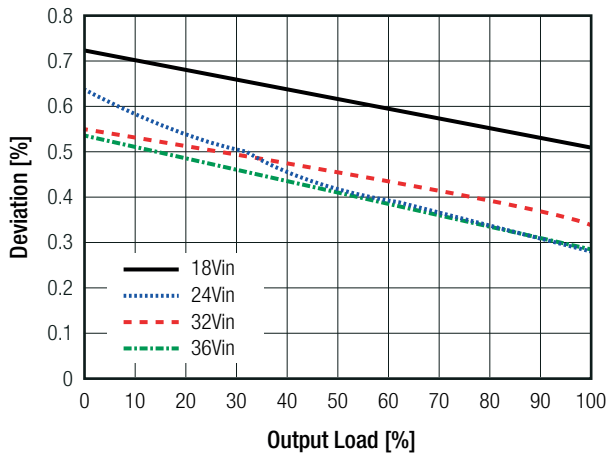

Power Dissipation

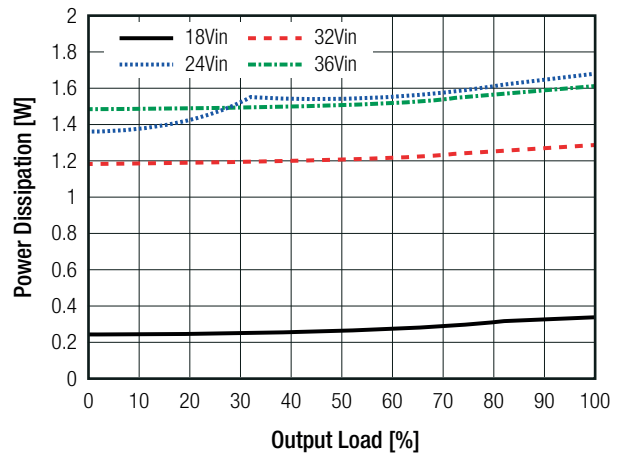

TYPICAL PERFORMANCE CHARACTERISTICS ($V_{OUT}= 24VDC$, $T_J= +25^{\circ}C$; tested with RECOM evaluation module: RPX-0.5Q-EVM-1)

Efficiency vs. Output current

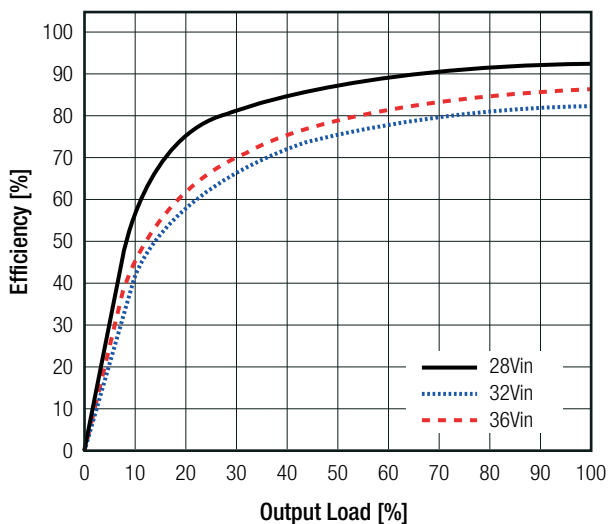

Thermal Derating

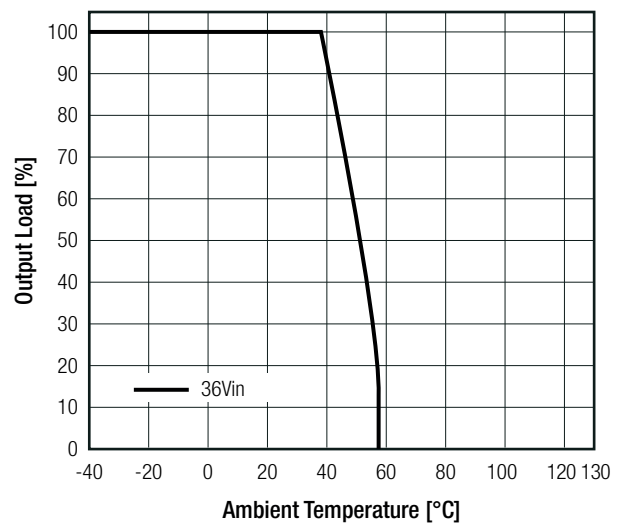

continued on next page

Specifications

TYPICAL PERFORMANCE CHARACTERISTICS ($V_{OUT}= 24VDC$, $T_J= +25^{\circ}C$; tested with RECOM evaluation module: RPX-0.5Q-EVM-1)

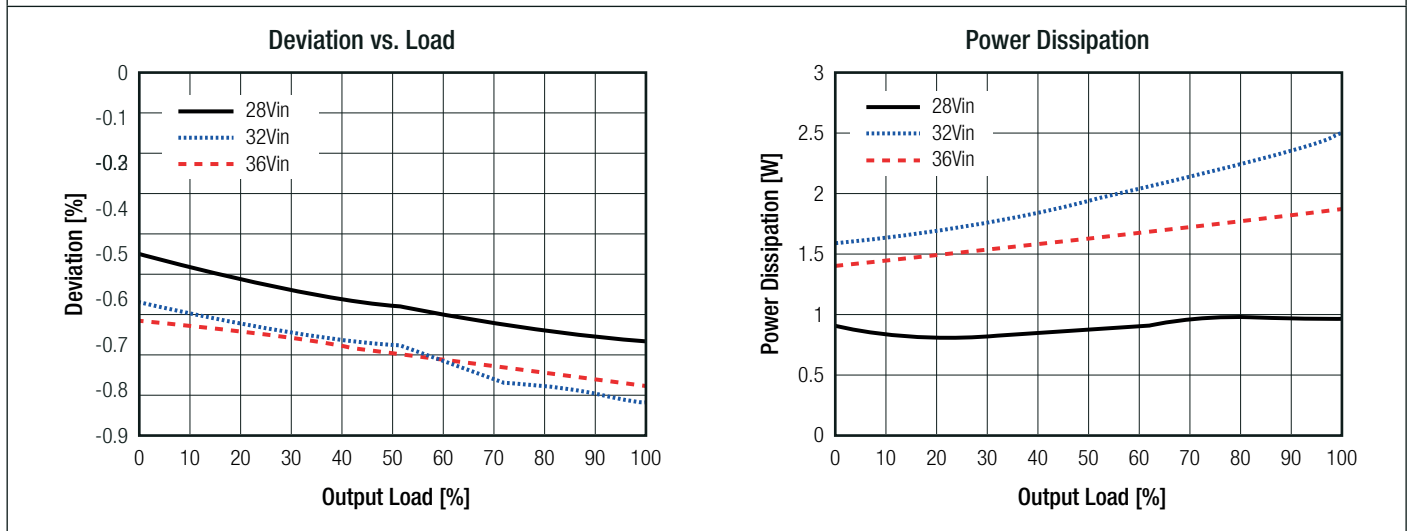

ENVIRONMENTAL

Parameter	Condition	Value
ESD	human-body model (HBM), ANSI/ESDA/JEDEC JS-001	±2kV
	charged-device model (CDM), JEDEC JESD22-C101	±0.75kV
Moisture Sensitive Level	MSL peak temp. ⁽⁷⁾	Level 3, 260°C, 168hrs

Notes:

Note7: The Moisture Sensitivity Level rating is according to the JEDEC industry standard classifications and peak solder temperature

SAFETY AND CERTIFICATIONS

Certificate Type (Safety)	Standard
RoHS2	RoHS 2011/65EU + AM2015/863

DIMENSION AND PHYSICAL CHARACTERISTICS

Parameter	Type	Value
Material	case	plastic
Dimension (LxWxH)		3.0 x 5.0 x 1.6mm
Weight		0.095g

continued on next page

Specifications

Dimension Drawing (mm)

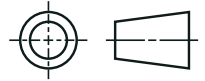
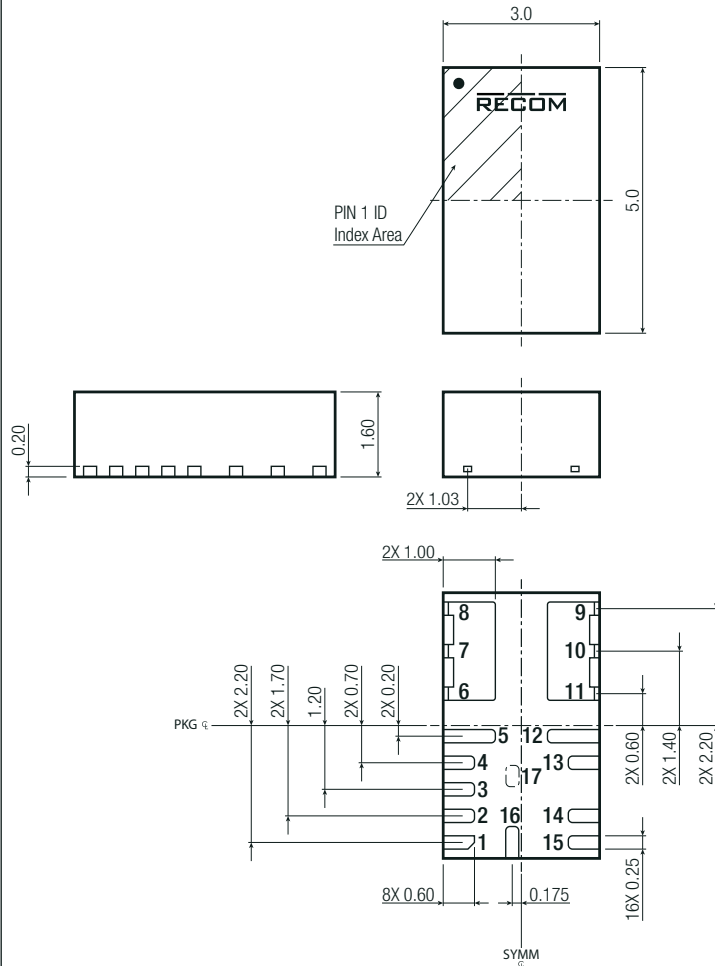

Pad Information

Pad #	Function	Description
1	PG	Output power good. High = Vout at set level, low = Vout below nominal regulation. Leave floating if not used
2	CTRL/ SYNC	Pull high to enable the RPX-0.5QQ. Leave open or connect to ground to disable the device. Apply external clock to synchronize switching frequency.
3	FB	Feedback input. Used to set the output voltage between 0.8V and 30VDC.
4	PGS	Power good source
5	AGND	Analog ground. Reference ground of logic circuit. AGND is connected to PGND internally.
6,7,8,12	SW	Switch node. Connect 6, 7, and 8 to large copper pad for optimal heat dissipation.
9,10,11	Vout	Output Voltage. Connect external capacitor between this pin and GND as close to the pins as possible.
13	DNC	Do not connect. Must be soldered to an isolated pad.
14,15	PGND	Power Ground. Connect these pins to the power ground plane on the PCB
16	Vin	Input Voltage. Connect a low-ESR low-inductance external bypass capacitor between this pin and GND as close to the pins as possible
17	DNC	Do not connect. Leave Floating

Tolerances: according to JEDEC MO-220

Lead side is wettable and coplanarity shall be 0.10mm max.

Wettable Flanks Detail (Top View)

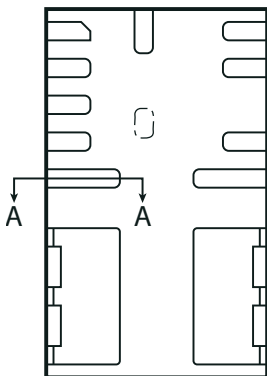

Section A-A

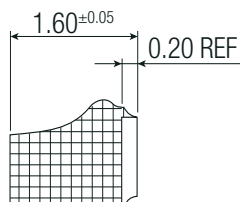

Recommended Footprint Details (Top View)

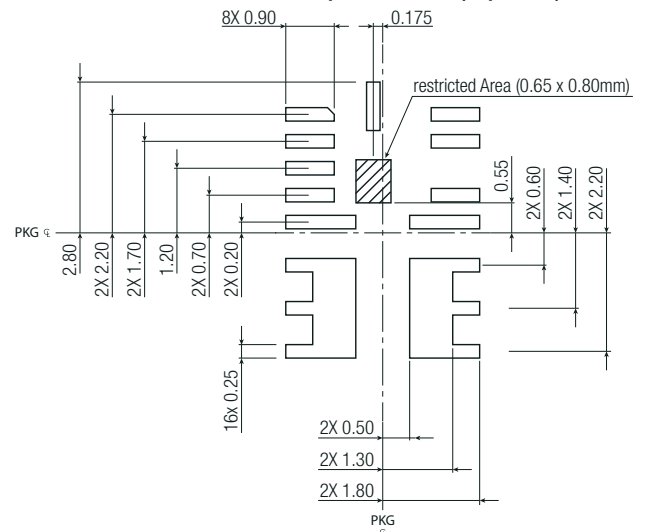

Specifications

SOLDERING

Wave or Reflow etc.

Profile Feature	PB-Free Assembly
Preheat	
minimum Temperature (TS_min)	155°C
maximum Temperature (TS_max)	245°C
Time (tS)	100s-300s
Liquidus	
Temperature (TL)	217°C
Time (tL)	30-60s
Peak Temperature (TP)	
Time remaining around Peak Temperature	10s
max Ramp Down Rate (from Ts_max to TP)	5K/s
max Ramp Up Rate	3K/s
max time from 25°C to Peak Temperature (TP)	8min

- 1 Pb-Free assembly is recommended according to JEDEC J-STD020.
- 2 Ensure that the peak reflow temperature does not exceed 240°C ±5°C as per JEDEC J-STD020
- 3 The reflow time period during peak temperature of 240°C ±5°C should not exceed 30 seconds.
- 4 Reflow time above liquids (217°C) should not exceed 150 seconds.
- 5 For solder paste use a standard SAC Alloy such as SAC 305, type 3 or higher.
- 6 Other soldering methods (e.g. vapor-phase) are not verified and have to validate by the customer on his own risk.

Soldering temp. graph

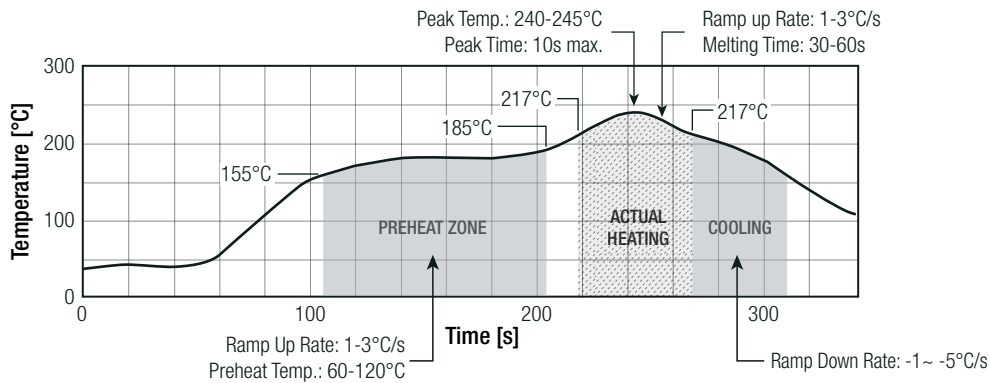

PCB LAYOUT SUGGESTION

Efficient PCB layout, especially of the input capacitor placement, is critical for stable operation. For best results, refer to Figure 6, and follow the guidelines below.

1. Connect a large ground plane to PGND pins 14 and 15 directly. If the bottom layer is a ground plane, add vias near GND.
2. Ensure that the high-current paths at GND and VIN have short, direct, and wide traces.
3. Place the ceramic input capacitor close to VIN and GND.
4. Keep the connection of the input capacitor and VIN as short and wide as possible.
5. Place the external feedback resistors next to FB and AGND.
6. Feedback and switch node should be placed as far away from one another as possible.

continued on next page

Specifications

PCB LAYOUT SUGGESTION

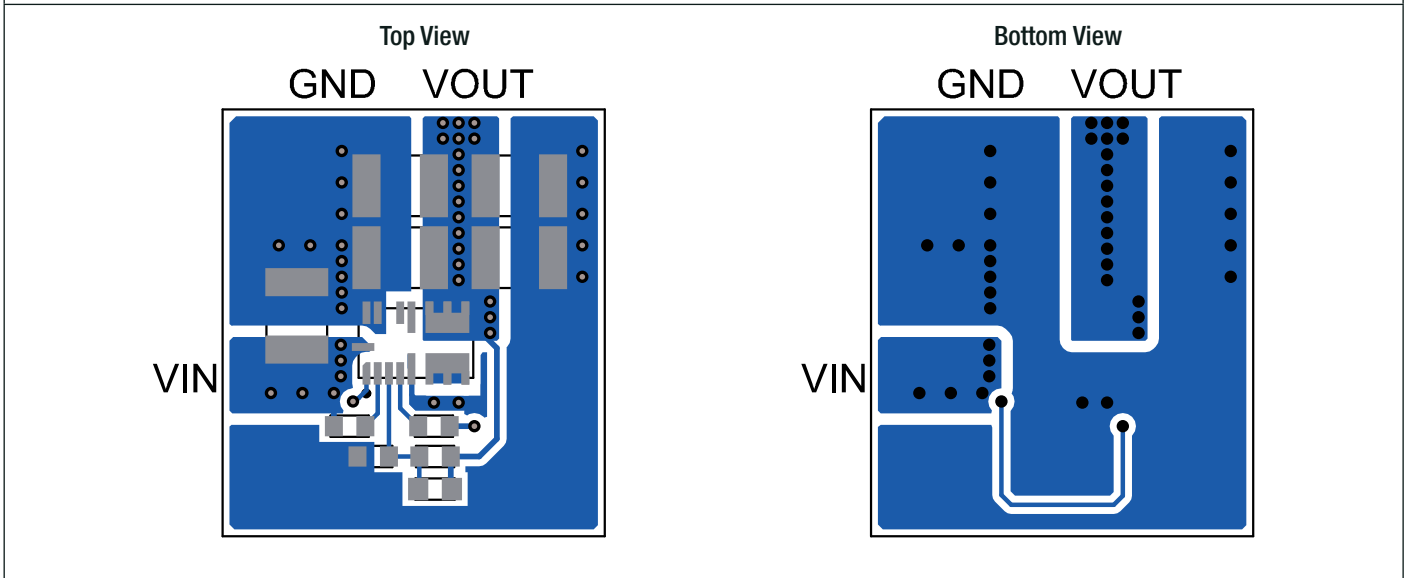

PACKAGING INFORMATION

Parameter	Type	Value
Packaging Dimension (LxWxH)	reel (diameter + width)	Ø177.8 x 12.4mm
	tape and reel (carton)	260.0 x 240.0 x 60.0mm
	moisture barrier bag ("-CT")	100.0 x 100.0 x 30mm
Packaging Quantity	tape and reel	500pcs
	moisture barrier bag ("-CT")	10pcs
Tape Width		12mm
Storage Temperature Range		-65°C to +150°C

The product information and specifications may be subject to changes even without prior written notice. The product has been designed for various applications; its suitability lies in the responsibility of each customer. The products are not authorized for use in safety-critical applications without RECOM's explicit written consent. A safety-critical application is an application where a failure may reasonably be expected to endanger or cause loss of life, inflict bodily harm or damage property. The applicant shall indemnify and hold harmless RECOM, its affiliated companies and its representatives against any damage claims in connection with the unauthorized use of RECOM products in such safety-critical applications.

X-ON Electronics

Largest Supplier of Electrical and Electronic Components

Click to view similar products for [Non-Isolated DC/DC Converters](#) category:

Click to view products by [RECOM POWER](#) manufacturer:

Other Similar products are found below :

[DP8160G-S1-R1](#) [APTH003A0X-SRZ](#) [CA-17205-L4](#) [PROPOWER-3.3V](#) [JRCS016A0S4-HZ](#) [VI-920194B](#) [T31SN24005NMFA](#) [RPX-4.0-R](#)
[TPSM5D1806RDBR](#) [XC9291B33E0R-G](#) [R-78K1.2-2.0L](#) [RPMGS12-20](#) [R-78K15-1.0](#) [R-78K2.5-2.0L](#) [R-78K15-2.0](#) [RGA4W250W010A-003](#)
[R-78K9.0-1.0](#) [RPX-0.5Q-R](#) [R-78K1.8-0.5](#) [RPMGQ12-20](#) [R-78K1.8-1.0](#) [R-78K2.5-0.5](#) [R-78K1.5-0.5](#) [RGC4W300W008A-001](#) [R-78K2.5-2.0](#)
[R-78K1.2-2.0](#) [R-78K9.0-2.0L](#) [R-78K1.8-2.0L](#) [R-78K1.5-2.0L](#) [RGA24250W014A-001](#) [RGC4W300W012A-001](#) [R-78K9.0-2.0](#) [RPMGS5.0-](#)
[20](#) [RGC4W300W012A-003](#) [RPY-1.5Q-R](#) [R-78K3.3-1.0](#) [R-78K1.8-2.0](#) [RGA4W250W010A-001](#) [R-78K3.3-2.0L](#) [R-78CK12-0.5](#) [R-78K2.5-](#)
[1.0](#) [R-78K12-1.0](#) [R-78K1.5-2.0](#) [RGC4W300W008A-003](#) [RGA24250W014A-003](#) [R-78K3.3-2.0](#) [BM2P134QF-E2](#) [R-78K12-2.0](#) [RPMGH12-](#)
[40](#) [RPMGH5.0-40](#)