

Features

Evaluation Module

- Evaluation platform for RPX-0.5Q Buck Regulator Module
- Thermal design considerations included
- EMI Class B filter
- Easy evaluation of output voltage selection, control and sensing functions

RECOM
Evaluation Module

RPX-0.5Q-EVM-1

Description

The RPX-0.5Q-EVM-1 generates a constant output voltage selectable from 0.8VDC, 1.8VDC, 3.3VDC, 5VDC, 12VDC, 15VDC or 24VDC from a DC input in the range of 4 – 36VDC. It has a maximum continuous output current of 0.5A.

All the functions of the RPX-0.5Q such as output voltage selection, control, power good, trim and output sense can be readily evaluated. Also the behavior in overload or over-temperature can be evaluated easily before it is designed in.

The evaluation board also contains the filter components to meet EMC Class B levels. Alternate component positions are included to allow experimentation to optimize the EMC performance depending on operating conditions and budget.

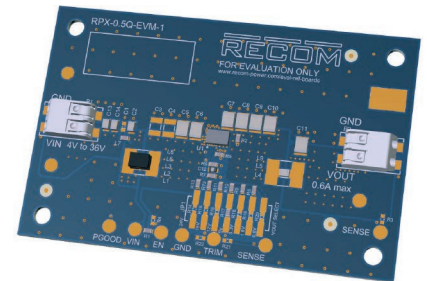

Selection Guide

Part Number	Input Voltage Range [VDC]	Output Voltage ⁽¹⁾ [VDC]	Output Current max. [A]
RPX-0.5Q-EVM-1	4 - 36	0.8, 1.8, 3.3, 5, 12, 15, 24	0.5

Notes:

Note1: refer to [SAFE OPERATING AREA](#) of RPX-0.5Q datasheet

Quick Start Guide

1. Connect P₁ to power supply (observe correct polarity)
2. Connect P₂ to the load (no load operation is allowed. Refer to safe operating area in the [RPX-0.5Q](#) datasheet)
3. The evaluation module is preset to 5V_{OUT}. The output voltage can be selected for values of 0.8VDC, 1.8VDC, 3.3VDC, 5VDC, 12VDC, 15VDC and 24VDC by shorting a 0Ω resistor to the respective places as seen in the board silkscreen. For 0.8V_{OUT}, please refer to safe operating area in the [RPX-0.5Q](#) datasheet.
4. The sense pin is connected to the RPX output pin, so the preset voltage is very accurate at the output of the RPX. To compensate any losses of the filter, remove the resistor at R₂, and solder a zero-ohm resistor at R₃.
5. The device is preset as normally on. It can be disabled by pulling the CTRL pad to GND. Short R₄ to disable the device.



Caution:

ESD sensitive. Always follow ESD preventative procedures when handling the product!

Specifications (measured @ Ta= 25°C, full load and after warm-up unless otherwise stated)

Component Placement

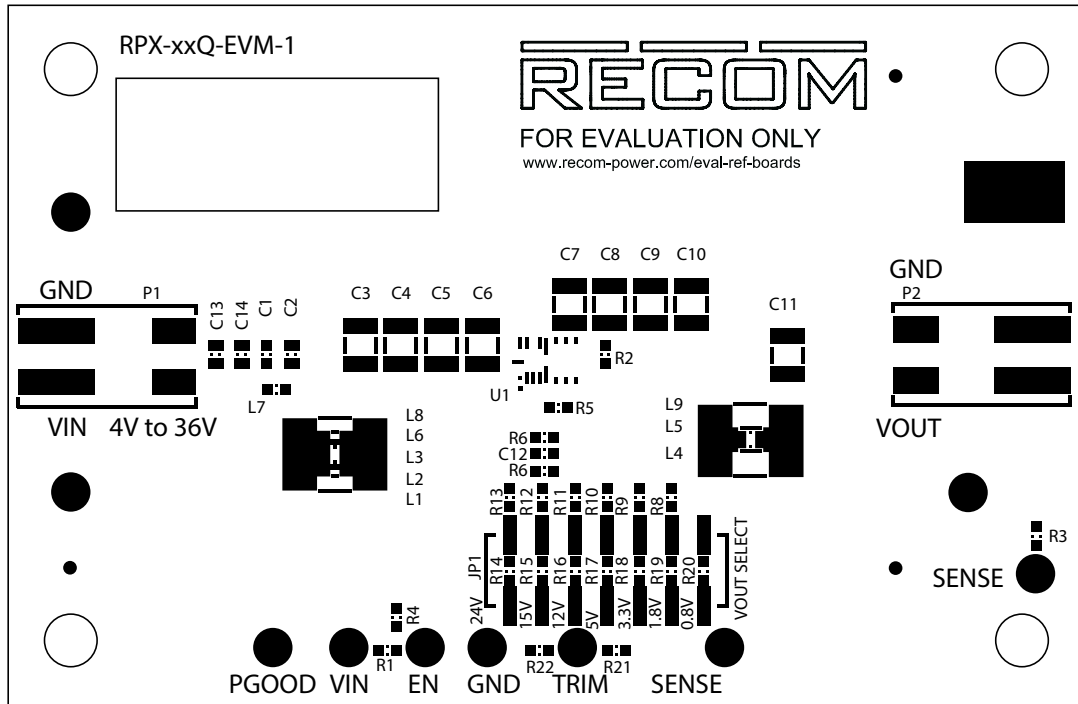

Connector Description

P1

Pin	Name	Description
1-2	GND	Common GND
3-4	VIN	Positive Input Voltage (observe correct polarity!)

P2

Pin	Name	Description
3-4	GND	Common GND
1-2	VOUT	Positive Output Voltage

Pads Direct Connection

Name	Description
GND	Negative Input Voltage (GND)
VIN	Positive Input Voltage
PGOOD	Power Good Signal
EN	EN Pad (leave open if not used)
TRIM	TRIM Pad (leave open if not used)
SENSE	Output Voltage Sense Pin (leave open if not used)
VOUT	Positive Output Voltage

Schematic

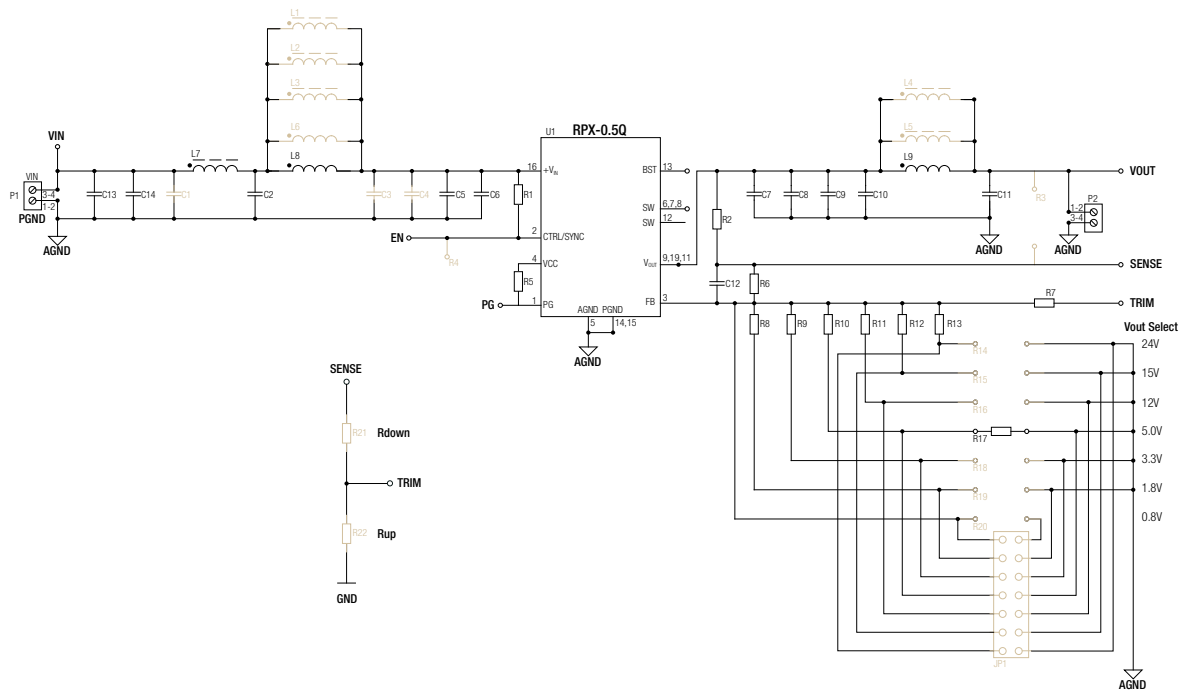

Notes:

Note2: Grey colored components are not mounted

Description

U₁: RPX-0.5Q power module.

C₁, C₂, L₁, L₂, L₃, L₆, L₇, L₈, C₃, C₄, C₅, C₆, C₁₃, C₁₄: allow placement of various sized components to test input filter design. The populated filter is designed to meet EN55022 class B.

C₇, C₈, C₉, C₁₀, L₄, L₅, L₉, C₁₁: allow placement of various sized components to test output filter design. The populated filter is designed to meet EN55022 class B.

R₁ and R₄: configure CTRL. R₁ is populated to enable the RPX-0.5Q. Short R₄ in order to disable the RPX-0.5Q.

R₂: populated 0Ω resistor for direct output voltage measurement. If sense is desired at a different location, (for example after the filter or directly at the load), unsolder R₂, and connect sense to the new measurement point.

R₃: sense point for output voltage after the filter. To set sense point here, remove R₂ and solder a 0Ω resistor at R₃.

V_{OUT} Selection: the output voltage can be selected with values of 0.8VDC, 1.8VDC, 3.3VDC, 5VDC, 12VDC, 15VDC, and 24VDC by shorting a 0Ω resistor to the respective places as seen in the board silkscreen. Instead of R₁₄-R₂₀ resistors, the JP₁ (SMT 2-row pin header) can be assembled and output voltage can be quickly set with jumper. Remove any resistor from positions R₁₄-R₂₀ before installing SMT header JP₁.

Note: For 0.8VDC output voltage the placement of 0Ω resistor or the jumper is not required since the feedback is internally disconnected in the board. See the connection of R₂₀ in the schematic.

R₂₁, R₂₂: trim the output voltage. Refer to **"OUTPUT VOLTAGE TRIMMING"**

OUTPUT VOLTAGE TRIMMING

The RPX-0.5Q-EVM-1 offers the feature of trimming the output voltage by using external trim resistors. The values for trim resistors are shown in trim tables below according to E96 values; therefore, the specified voltage may slightly vary. Refer to "Selection Guide" for applicable V_{OUT} range.



Calculation:

V_{out_{nom}} = nominal output voltage [VDC]
 V_{out_{set}} = trimmed output voltage [VDC]
 V_{ref} = reference voltage [VDC]
 R_{up} = trim up resistor [kΩ]
 R_{down} = trim down resistor [kΩ]
 R_{FB1} (R_L), R_{FB2} (R_H) = feedback resistors [kΩ]

$$R_{up} = \frac{R_H R_L V_{REF}}{R_L (V_{out_{set}} - V_{REF}) - R_H V_{REF}} \text{ [k}\Omega\text{]}$$

$$R_{down} = \frac{R_H R_L (V_{out_{set}} - V_{REF})}{V_{REF} \times (R_H + R_L) - V_{out_{set}} R_L} \text{ [k}\Omega\text{]}$$

Vout _{nom}	R _L R _{FB1} [kΩ]	R _H R _{FB2} [kΩ]
1.8VDC	60k4	75k
3.3VDC	24k3	75k
5VDC	14k3	75k
12VDC	5k36	75k
15VDC	4k22	75k
24VDC	2k61	75k

Practical Example RPX-0.5Q, trim up:

V_{out_{set}} = 5.1VDC

$$R_{up} = \frac{75 \times 14.3 \times 0.8}{14.3 \times (5.1 - 0.8) - 75 \times 0.8} = \underline{\underline{575.838k\Omega}}$$

R_{up} according to E96 ≈ 576kΩ

Practical Example RPX-0.5Q, trim down:

V_{out_{set}} = 4VDC

$$R_{down} = \frac{75 \times 14.3 \times (4 - 0.8)}{0.8 \times (75 + 14.3) - 4 \times 14.3} = \underline{\underline{241.011k\Omega}}$$

R_{down} according to E96 ≈ 243kΩ

V_{out_{set}} = 1.8VDC

Trim up

V _{out_{set}} =	1.82	1.88	1.9	2.0	[VDC]
R _{up} (E96) ≈	2M26	698k	562k	287k	[Ω]

Trim down

V _{out_{set}} =	1.7	1.6	1.5	1.4	[VDC]
R _{down} (E96) ≈	715k	309k	178k	115k	[Ω]

V_{out_{set}} = 3.3VDC

Trim up

V _{out_{set}} =	3.4	3.5	3.6	3.8	[VDC]
R _{up} (E96) ≈	453k	255k	182k	113k	[Ω]

Trim down

V _{out_{set}} =	3.1	3.0	2.8	2.6	[VDC]
R _{down} (E96) ≈	1M02	604k	316k	200k	[Ω]

V_{out_{set}} = 5VDC

Trim up

V _{out_{set}} =	5.1	5.2	5.3	6.0	[VDC]
R _{up} (E96) ≈	576k	294k	196k	59k0	[Ω]

Trim down

V _{out_{set}} =	4.7	4.5	4.3	4.0	[VDC]
R _{down} (E96) ≈	976k	549k	374k	237k	[Ω]

V_{out_{set}} = 12VDC

Trim up

V _{out_{set}} =	12.4	12.6	13.0	13.2	[VDC]
R _{up} (E96) ≈	147k	100k	59k	49k9	[Ω]

Trim down

V _{out_{set}} =	11	10.6	10	9.6	[VDC]
R _{down} (E96) ≈	768k	523k	348k	247k	[Ω]

continued on next page

Specifications (measured @ Ta= 25°C, full load and after warm-up unless otherwise stated)

OUTPUT VOLTAGE TRIMMING

V_{outset} = 15VDC

Trim up

V _{outset} =	15.5	16	16.3	16.5	[VDC]
R _{up} (E96) ≈	124k	60k4	46k4	40k2	[Ω]

Trim down

V _{outset} =	14.5	14.0	13.5	13.0	[VDC]
R _{down} (E96) ≈	2M05	976k	634k	453k	[Ω]

V_{outset} = 24VDC

Trim up

V _{outset} =	25	25.5	26	26.4	[VDC]
R _{up} (E96) ≈	49k9	34k8	27k4	22k6	[Ω]

Trim down

V _{outset} =	23.0	22.0	20.0	19.2	[VDC]
R _{down} (E96) ≈	2M05	887k	383k	301k	[Ω]

DIMENSION AND PHYSICAL CHARACTERISTICS

Parameter	Type	Value
Dimension (LxWxH)		85.0 x 55.0 x 6.5mm
Weight		21g

Layout

Top Layer

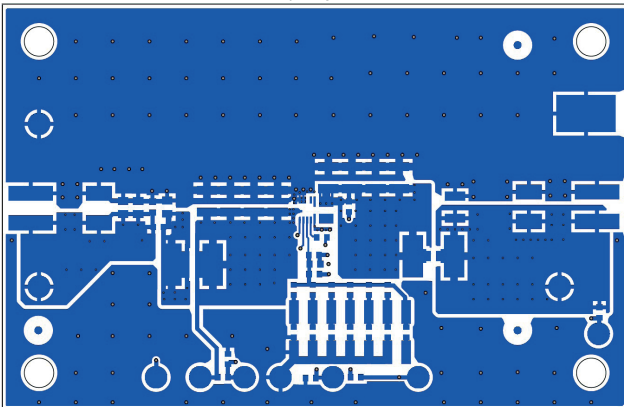

Layer 2

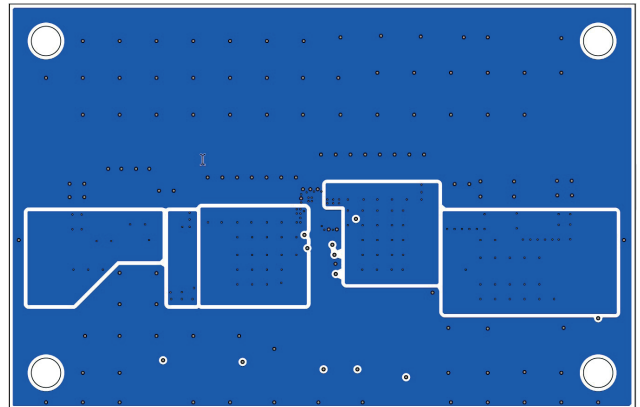

Layer 3

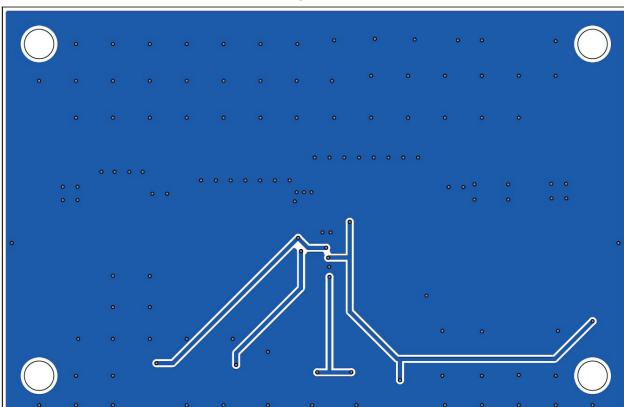

Bottom Layer

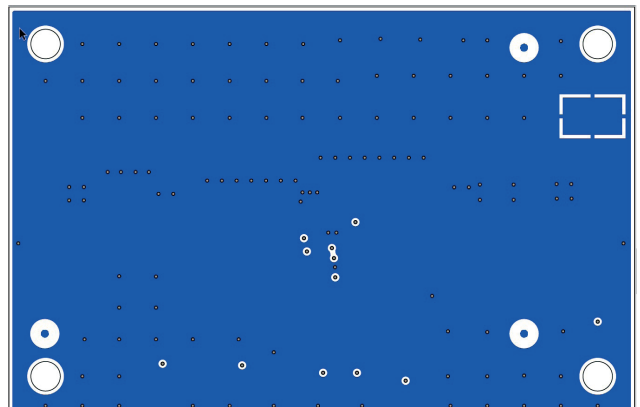

Notes:

Note3: Visit www.recom-power.com/eval-ref-boards to download the Gerber files

Specifications (measured @ Ta= 25°C, full load and after warm-up unless otherwise stated)

BOM				
Comp.	Description	Manufacturer Part Number	Manufacturer	Remarks
C1	CAP 0603			not mounted
C2	1uF 50V X7R 0805	CL21B105KBFNNNF	Samsung Electro-Mechanics	
C3, C4	CAP 1210			not mounted
C5, C6, C7, C8, C9, C10, C11	10uF 50V X7R 1210	CL32B106KBJNWE	Samsung Electro-Mechanics	
C12	33pF 50V COG 0603	CL10C330JB8NNNC	Samsung Electro-Mechanics	
C13, C14	4.7uF 50V X7R 0805	CGA4J1X7R1H475K125AE	TDK	
L1, L2, L3, L4, L5, L6	FERRITE BEAD			not mounted
L7	FERRITE BEAD 33 OHM 0603	BLM18PG330SN1D	MURATA	
L8	IND 3.9uH 1.32A 140mΩ	RLS-397	RECOM	
L9	FERRITE BEAD 600 OHM 0805	742792040	WURTH	
P1, P2	CONNECTOR	2060-452/998-404	WAGO	
R1	301kΩ 0.1W 0603	RC0603FR-07301KL	YAGEO	
R2, R17	0Ω 0.1W 0603	RC0603JR-070RL	YAGEO	
R3, R4, R14, R15, R16, R18, R19, R20, R21, R22	RES 0603			not mounted
R5	100kΩ 0.1W 0603	RC0603FR-07100KL	YAGEO	
R6	75kΩ 0.1W 0603	RC0603FR-0775KL	YAGEO	
R7	1kΩ 0.1W 0603	RC0603FR-071KL	YAGEO	
R8	60.4kΩ 0.1W 0603	RC0603FR-0760K4L	YAGEO	
R9	24.3kΩ 0.1W 0603	RC0603FR-0724K3L	YAGEO	
R10	14.3kΩ 0.1W 0603	RC0603FR-0714K3L	YAGEO	
R11	5.36kΩ 0.1W 0603	RC0603FR-075K36L	YAGEO	
R12	4.22kΩ 0.1W 0603	RC0603FR-074K22L	YAGEO	
R13	2.61kΩ 0.1W 0603	RC0603FR-072K61L	YAGEO	
U1	RPX-0.5Q MODULE	RPX-0.5Q	RECOM	

PACKAGING INFORMATION

Parameter	Type	Value
Packaging Dimension (LxWxH)		114.0 x 60.0 x 28.0mm
Packaging Quantity		1pc

Contents

- RPX-0.5Q-EVM-1 Evaluation Module
- Terms and Conditions

The product information and specifications may be subject to changes even without prior written notice. The product has been designed for various applications; its suitability lies in the responsibility of each customer. The products are not authorized for use in safety-critical applications without RECOM's explicit written consent. A safety-critical application is an application where a failure may reasonably be expected to endanger or cause loss of life, inflict bodily harm or damage property. The applicant shall indemnify and hold harmless RECOM, its affiliated companies and its representatives against any damage claims in connection with the unauthorized use of RECOM products in such safety-critical applications.

X-ON Electronics

Largest Supplier of Electrical and Electronic Components

Click to view similar products for [Power Management IC Development Tools](#) category:

Click to view products by [RECOM POWER](#) manufacturer:

Other Similar products are found below :

[EVB-EP5348UI](#) [DA9063-EVAL](#) [BQ24155EVM](#) [BQ25010EVM](#) [REG710EVM-5](#) [TPS54980EVM-022](#) [TPS65010EVM-230](#) [BQ24120EVM-001](#) [BQ24212EVM-678](#) [BQ3050EVM-001](#) [ISL9520EVAL1Z](#) [UCC3809EVM](#) [LM3691TL-1.2EV/NOPB](#) [SOT23-3EV-VREG](#) [SOT89-3EV-VREG](#) [TPS2458EVM](#) [TPS54229EEVM-056](#) [TPS54329EEVM-056](#) [MAX8556EVKIT](#) [MAX20012EVKIT#](#) [MAX15005AEVKIT+](#) [S6SBP203A8FVA1001](#) [TPS652510EVM](#) [STEVAL-ISA047V1](#) [ISL8502AEVAL1Z](#) [ISL8009AEVAL1Z](#) [TPS76901EVM-127](#) [FRDM-HB2001-EVM](#) [BM6208FS-EVK-001](#) [LM5115EVAL](#) [LP5900TL-2.5EV](#) [DRI0043](#) [7E.12.8.230.0002](#) [KITPF8100FRDMEVM](#) [NCP10671B05GEVB](#) [MAX20073EVKIT#](#) [EVB-EN6337QA](#) [AP3125AEV1](#) [NIV6350MT2GEVB](#) [XMCA1](#) [RD33771-48VEVM](#) [EVKT-MPM3695-10-A](#) [DEMO200W12VDCLLC](#) [SAMPLEBOXILD8150TOBO1](#) [MAX18066EVKIT#](#) [AP61100Z6-EVM](#) [AP62300WU-EVM](#) [KIT8020-CRD-8FF1217P-1](#) [KITPF8121FRDMEVM](#) [EV2174C-G-00A](#)