

SCHOTTKY BARRIER DIODE

FEATURES

- Extremely Fast Switching Speed
- Halogen-free

SOT-23

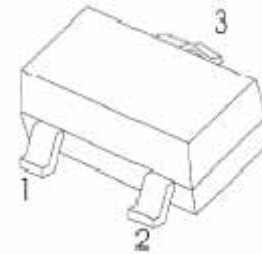

MARKING:

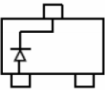
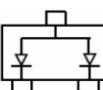
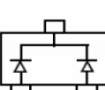
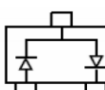
BAT54	BAT54A	BAT54C	BAT54S
			
Marking KL1	Marking KL2	Marking KL3	Marking KL4
Marking KL1/L4/L4P	Marking KL2/L42	Marking KL3/L43	Marking KL4/L44

MAXIMUM RATINGS (T_a=25°C unless otherwise noted)

Parameter	Symbol	Value	Unit
Peak Repetitive Reverse Voltage	V _{RRM}	40	V
Working Peak Reverse Voltage	V _{RWM}		
DC Blocking Voltage	V _R		
Forward Continuous Current	I _{FM}	200	mA
Non-repetitive Peak Forward Surge Current @ t=8.3ms	I _{FSM}	600	mA
Repetitive Peak Forward Current @ t≤1s, δ ≤0.5	I _{FRM}	300	mA
Typical Current Squared Time	I ² T	0.15	A ² S
Power Dissipation	P _D	200	mW
Thermal Resistance from Junction to Ambient	R _{θJA}	500	°C/W
Junction Temperature	T _j	125	°C
Storage Temperature	T _{stg}	-55~+150	°C

ELECTRICAL CHARACTERISTICS(T_a=25°C unless otherwise specified)

Parameter	Symbol	Min	Typ	Max	Unit	Test conditions
Reverse voltage	V _(BR)	40			V	I _R =100μA
Forward voltage	V _F			0.24	V	I _{F1} =0.1mA
				0.32	V	I _{F2} =1mA
				0.40	V	I _{F3} =10mA
				0.50	V	I _{F4} =30mA
				1	V	I _{F5} =100mA
Reverse current	I _R			2	μA	V _R =25V
Diode capacitance	C _D			10	pF	V _R =1V, f=1MHz
Reverse recovery time	t _{rr}			5	ns	I _F =I _R =10mA I _{rr} =0.1 × I _R , R _L =100 Ω

RATING AND CHARACTERISTIC CURVES (BAT54/A/C/S)

Forward Characteristics

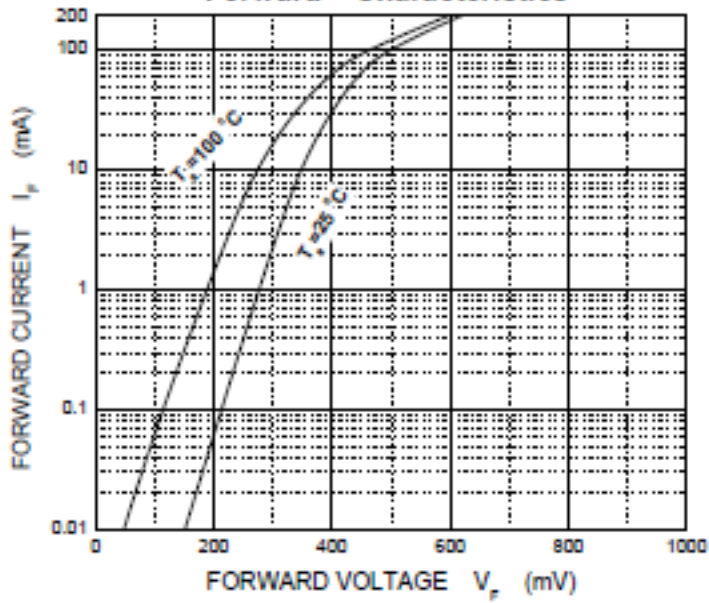

Reverse Characteristics

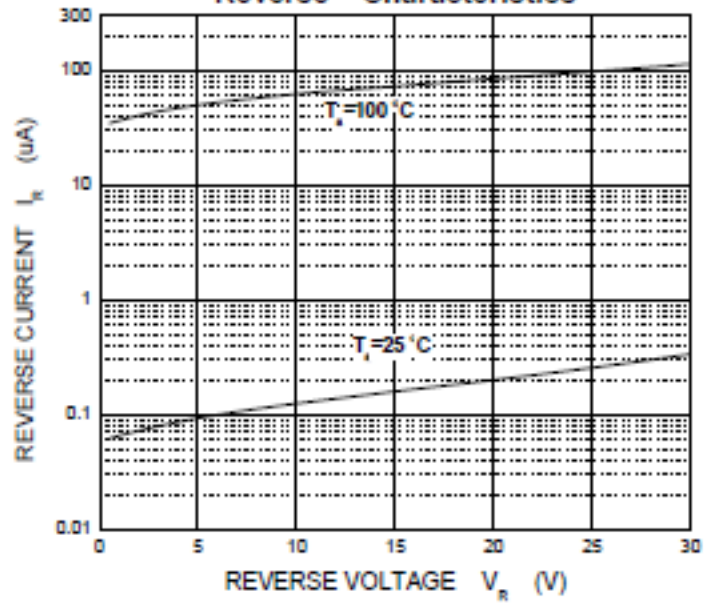

Capacitance Characteristics

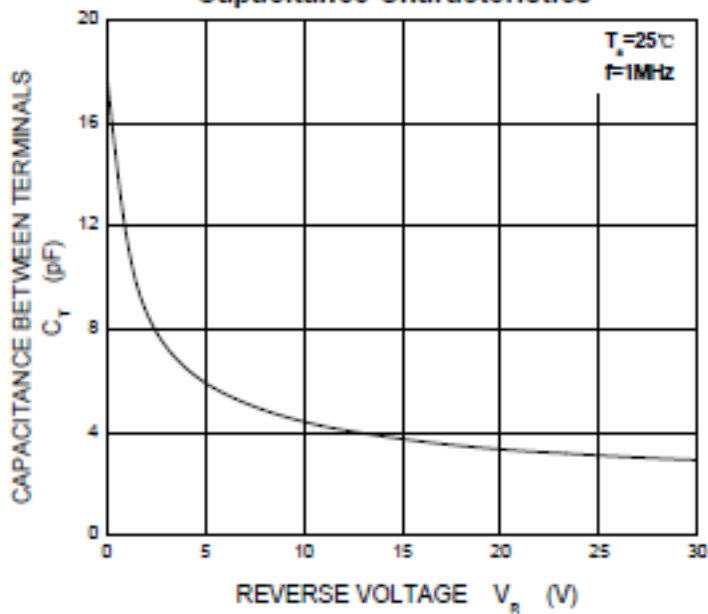

Power Derating Curve

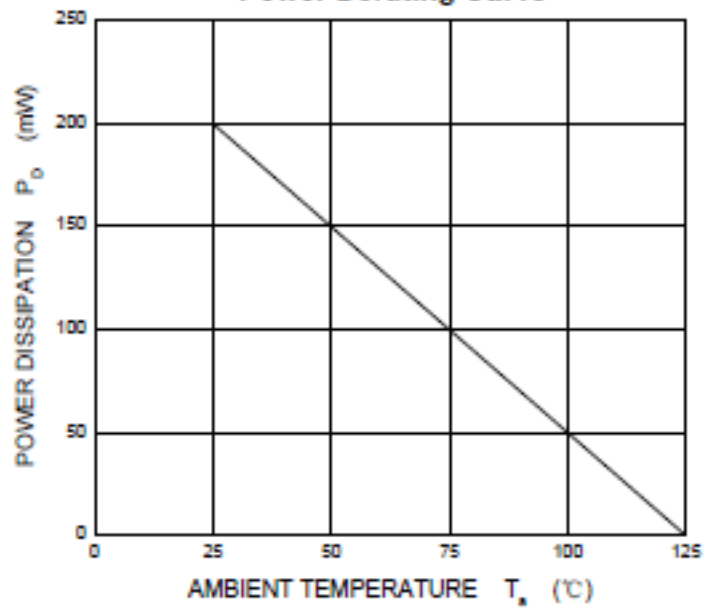

SOT-23 Package Outline Dimensions

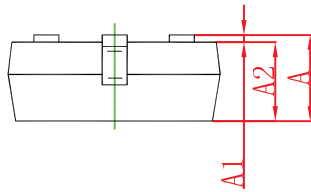
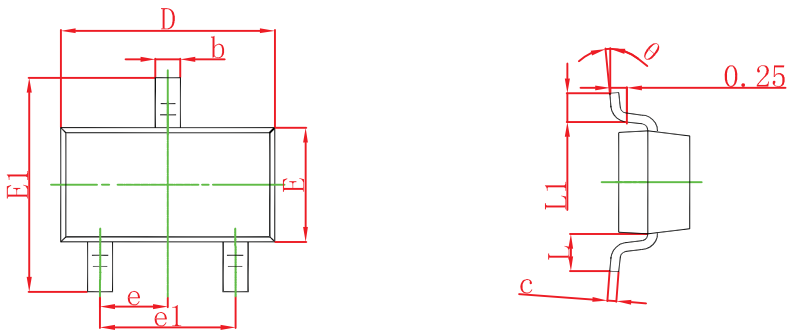

Symbol	Dimensions In Millimeters		Dimensions In Inches	
	Min	Max	Min	Max
A	0.900	1.150	0.035	0.045
A1	0.000	0.100	0.000	0.004
A2	0.900	1.050	0.035	0.041
b	0.300	0.500	0.012	0.020
c	0.080	0.150	0.003	0.006
D	2.800	3.000	0.110	0.118
E	1.200	1.400	0.047	0.055
E1	2.250	2.550	0.089	0.100
e	0.950 TYP		0.037 TYP	
e1	1.800	2.000	0.071	0.079
L	0.550 REF		0.022 REF	
L1	0.300	0.500	0.012	0.020
θ	0°	8°	0°	8°

SOT-23 Suggested Pad Layout

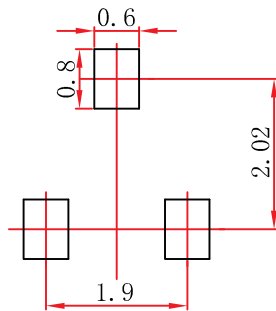

Note:

1. Controlling dimension; in millimeters.
2. General tolerance: ± 0.05 mm.
3. The pad layout is for reference purposes only.

SOT-23 Tape and Reel

SOT-23 Embossed Carrier Tape

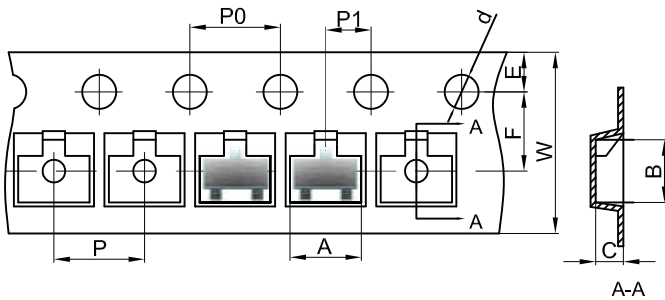

Packaging Description:

SOT-23 parts are shipped in tape. The carrier tape is made from a dissipative (carbon filled) polycarbonate resin. The cover tape is a multilayer film (Heat Activated Adhesive in nature) primarily composed of polyester film, adhesive layer, sealant, and anti-static sprayed agent. These reeled parts in standard option are shipped with 3,000 units per 7" or 17.8cm diameter reel. The reels are clear in color and is made of polystyrene plastic (anti-static coated).

Dimensions are in millimeter										
Pkg type	A	B	C	d	E	F	P0	P	P1	W
SOT-23	3.15	2.77	1.22	Ø1.50	1.75	3.50	4.00	4.00	2.00	8.00

SOT-23 Tape Leader and Trailer

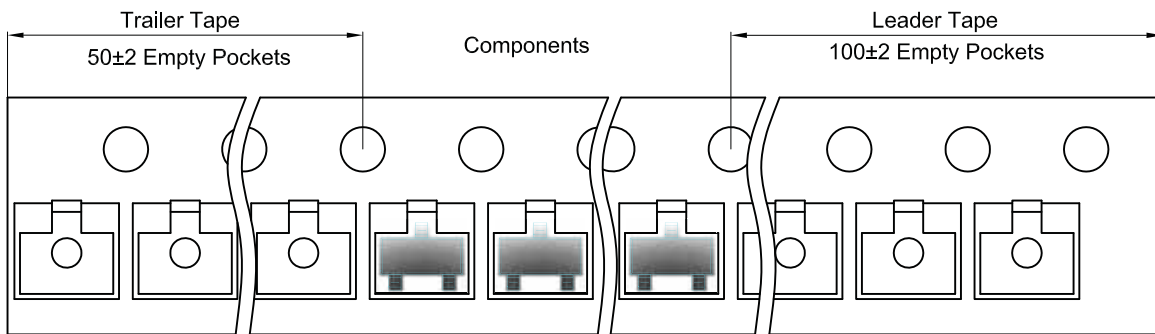

SOT-23 Reel

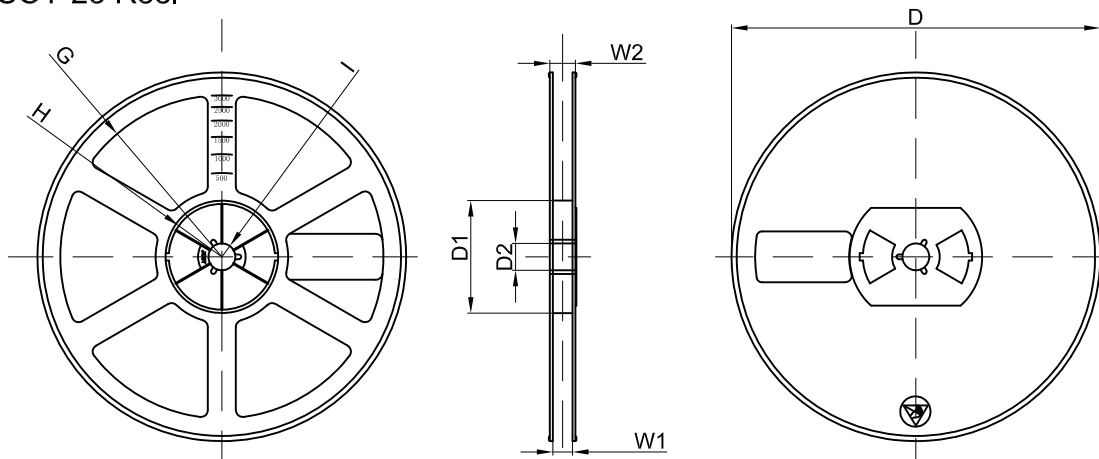

Dimensions are in millimeter								
Reel Option	D	D1	D2	G	H	I	W1	W2
7" Dia	Ø178.00	54.40	13.00	R78.00	R25.60	R6.50	9.50	12.30

REEL	Reel Size	Box	Box Size(mm)	Carton	Carton Size(mm)	Package Code
3000 pcs	7 inch	45,000 pcs	203×203×195	180,000 pcs	438×438×220	-T

DISCLAIMER NOTICE

Rectron Inc reserves the right to make changes without notice to any product specification herein, to make corrections, modifications, enhancements or other changes. Rectron Inc or anyone on its behalf assumes no responsibility or liability for any errors or inaccuracies. Data sheet specifications and its information contained are intended to provide a product description only. "Typical" parameters which may be included on RECTRON data sheets and/ or specifications can and do vary in different applications and actual performance may vary over time. Rectron Inc does not assume any liability arising out of the application or use of any product or circuit.

Rectron products are not designed, intended or authorized for use in medical, life-saving implant or other applications intended for life-sustaining or other related applications where a failure or malfunction of component or circuitry may directly or indirectly cause injury or threaten a life without expressed written approval of Rectron Inc. Customers using or selling Rectron components for use in such applications do so at their own risk and shall agree to fully indemnify Rectron Inc and its subsidiaries harmless against all claims, damages and expenditures.

X-ON Electronics

Largest Supplier of Electrical and Electronic Components

Click to view similar products for [Schottky Diodes & Rectifiers](#) category:

Click to view products by [Rectron](#) manufacturer:

Other Similar products are found below :

[MA4E2039](#) [D1FH3-5063](#) [MBR10100CT-BP](#) [MBR1545CT](#) [MMBD301M3T5G](#) [RB160M-50TR](#) [RB551V-30](#) [BAS16E6433HTMA1](#) [BAT](#)
[54-02LRH E6327](#) [NSR05F40QNXT5G](#) [NTE555](#) [JANS1N6640](#) [SB07-03C-TB-H](#) [SB1003M3-TL-W](#) [SK310-T](#) [SK32A-LTP](#) [SK33A-TP](#)
[SK34B-TP](#) [SS3003CH-TL-E](#) [GA01SHT18](#) [CRS10I30A\(TE85L,QM](#) [MA4E2501L-1290](#) [MBRB30H30CT-1G](#) [SB007-03C-TB-E](#) [SK32A-TP](#)
[SK33B-TP](#) [SK35A-TP](#) [SK38B-TP](#) [NRVBM120LT1G](#) [NTE505](#) [NTSB30U100CT-1G](#) [SS15E-TP](#) [VS-6CWQ10FNHM3](#) [ACDBA1100LR-HF](#)
[ACDBA1200-HF](#) [ACDBA140-HF](#) [ACDBA2100-HF](#) [ACDBA3100-HF](#) [CDBQC0530L-HF](#) [CDBQC0240LR-HF](#) [ACDBA340-HF](#)
[ACDBA260LR-HF](#) [ACDBA1100-HF](#) [SK310B-TP](#) [MA4E2502L-1246](#) [MA4E2502H-1246](#) [NRVBM120ET1G](#) [NSR01L30MXT5G](#) [NTE573](#)
[NTE6081](#)