

HIGH VOLTAGE ASSEMBLED RECTIFIER

VOLTAGE RANGE 5000 to 16000 Volts CURRENT 0.35 Amperes

FEATURES

- * Low cost
- * Low leakage
- * Isolated case
- * Surge overload rating - 50 amperes peak
- * Mounting position: Any
- * Low forward voltage drop

MECHANICAL DATA

- * Epoxy : Device has UL flammability classification 94V-0



HVM

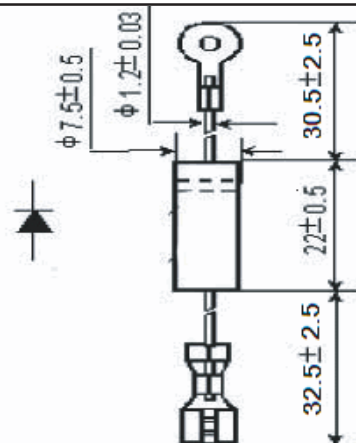

Dimensions in millimeters

MAXIMUM RATINGS AND ELECTRICAL CHARACTERISTICS

Ratings at 25 °C ambient temperature unless otherwise specified.
 Single phase, half wave, 60 Hz, resistive or inductive load.
 For capacitive load, derate current by 20%.

MAXIMUM RATINGS (At TA = 25°C unless otherwise noted)

RATINGS	SYMBOL	HVM5	HVM8	HVM10	HVM12	HVM14	HVM15	HVM16	UNITS
Maximum Recurrent Peak Reverse Voltage	VRRM	5	8	10	12	14	15	16	K Volts
Maximum RMS Voltage	VRMS	3.5	5.6	7.0	8.4	9.8	10.5	11.2	K Volts
Maximum DC Blocking Voltage	VDC	5	8	10	12	14	15	16	K Volts
Maximum Average Forward Rectified Current at TA = 50°C	Io	350							mAmps
Peak Forward Surge Current 8.3 ms single half sine-wave superimposed on rated load (JEDEC method)	IFSM	50							Amps
Operating and Storage Temperature Range	TJ,TSTG	-20 to + 150							°C

ELECTRICAL CHARACTERISTICS (At TA = 25°C unless otherwise noted)

CHARACTERISTICS	SYMBOL	HVM5	HVM8	HVM10	HVM12	HVM14	HVM15	HVM16	UNITS	
Maximum Instantaneous Forward Voltage at 0.35A DC	VF	8.0	14.0							Volts
Maximum DC Reverse Current at Rated DC Blocking Voltage	IR	5.0							uAmps	

- NOTES: 1. Enough heat sink must be considered in application.
 2. Operating and Storage Temperature : -20°C to +150°C
 3. Suffix " L " for Wire type.

RATING AND CHARACTERISTIC CURVES (HVM5 THRU HVM16)

FIG. 1 - TYPICAL FORWARD CURRENT DERATING CURVE

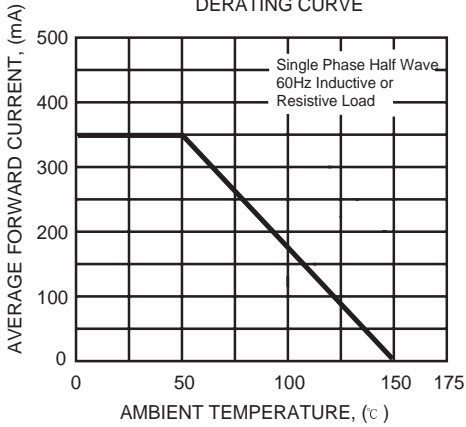

FIG. 2 - MAXIMUM NON-REPETITIVE FORWARD SURGE CURRENT

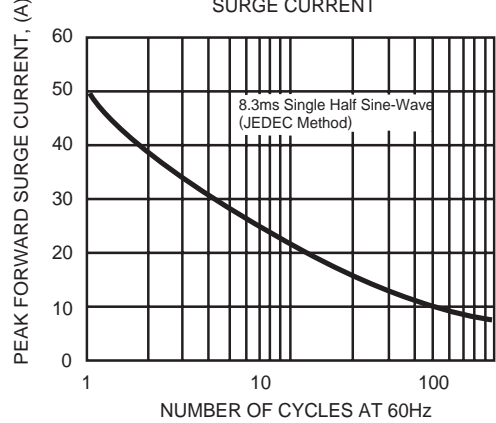

FIG. 3 - TYPICAL REVERSE CHARACTERISTICS

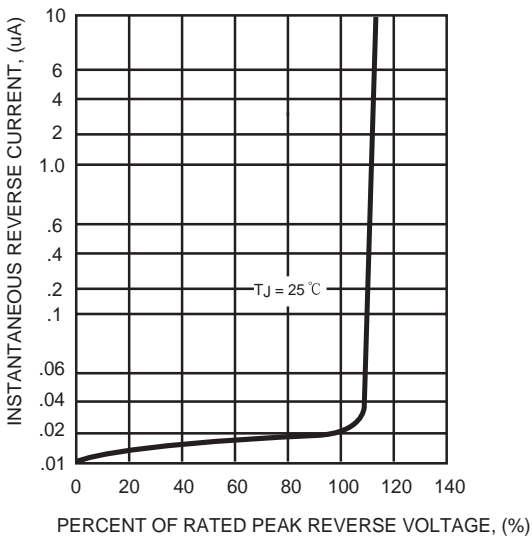
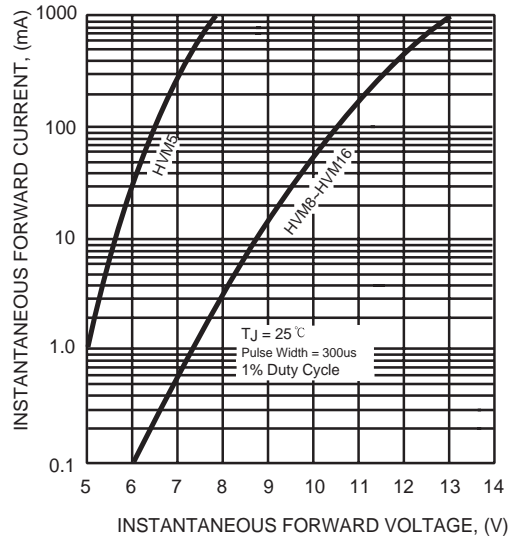
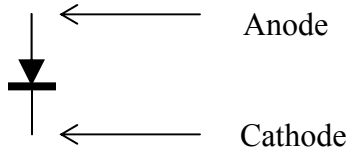

FIG. 4 - TYPICAL INSTANTANEOUS FORWARD CHARACTERISTICS



1. Internal Circuit



2. Marking on the body

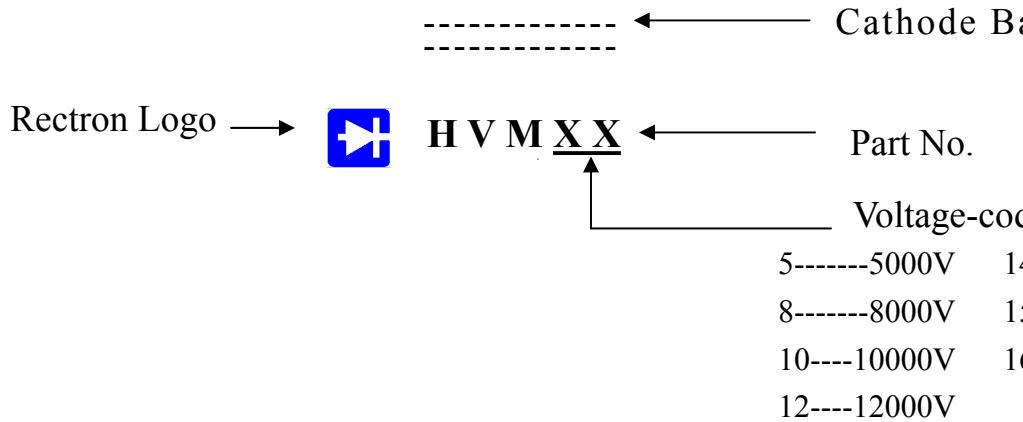

4. Items marked on the carton

CUSTOMER
TYPE
QUANTITY
LOT NO.
REMARK

Rectron Inc reserves the right to make changes without notice to any product specification herein, to make corrections, modifications, enhancements or other changes. Rectron Inc or anyone on its behalf assumes no responsibility or liability for any errors or inaccuracies. Data sheet specifications and its information contained are intended to provide a product description only. "Typical" parameters which may be included on RECTRON data sheets and/ or specifications can and do vary in different applications and actual performance may vary over time. Rectron Inc does not assume any liability arising out of the application or use of any product or circuit.

Rectron products are not designed, intended or authorized for use in medical, life-saving implant or other applications intended for life-sustaining or other related applications where a failure or malfunction of component or circuitry may directly or indirectly cause injury or threaten a life without expressed written approval of Rectron Inc. Customers using or selling Rectron components for use in such applications do so at their own risk and shall agree to fully indemnify Rectron Inc and its subsidiaries harmless against all claims, damages and expenditures.

X-ON Electronics

Largest Supplier of Electrical and Electronic Components

Click to view similar products for [Rectifiers](#) category:

Click to view products by [Rectron](#) manufacturer:

Other Similar products are found below :

[70HFR40](#) [RL252-TP](#) [150KR30A](#) [1N5397](#) [NTE5841](#) [NTE6038](#) [SCF5000](#) [1N4002G](#) [1N4005-TR](#) [JANS1N6640US](#) [481235F](#)
[RRE02VS6SGTR](#) [067907F](#) [MS306](#) [70HF40](#) [T85HFL60S02](#) [US2JFL-TP](#) [A1N5404G-G](#) [CRS04\(T5L,TEMQ\)](#) [ACGRA4007-HF](#)
[ACGRB207-HF](#) [CLH03\(TE16L,Q\)](#) [ACGRC307-HF](#) [ACEFC304-HF](#) [NTE6356](#) [NTE6359](#) [NTE6002](#) [NTE6023](#) [NTE6039](#) [NTE6077](#)
[85HFR60](#) [40HFR60](#) [70HF120](#) [85HFR80](#) [D126A45C](#) [SCF7500](#) [D251N08B](#) [SCHJ22.5K](#) [SM100](#) [SCPA2](#) [SCH10000](#) [SDHD5K](#) [VS-](#)
[12FL100S10](#) [ACGRA4001-HF](#) [D1821SH45T PR](#) [D1251S45T](#) [NTE5990](#) [NTE6358](#) [NTE6162](#) [NTE5850](#)