

# SPECIFICATION

REFOND P/N

RF-BW0402DS-DD-B

R&D

Mass Product



## Contents

1. Description .....	3
1.1 General Description .....	3
1.2 Features .....	3
1.3 Application .....	3
1.4 Package Dimension .....	4
1.5 Product Parameters .....	5
1.6 Bin Range Of Forward Voltage and Luminous Flux (IF=5mA).....	7
1.7 Typical Optical Characteristics Curves .....	8
2. Packaging .....	12
2.1 Packaging Specification .....	12
2.1.1 Carrier Tape Dimension.....	12
2.1.2 Reel Dimension .....	12
2.1.3 Label Form Specification .....	13
2.2 Moisture Resistant Packing .....	13
2.3 Cardboard Box.....	14
2.4 Reliability Test Items And Conditions.....	14
2.5 Criteria For Judging Damage.....	15
3. SMT Reflow Soldering Instructions.....	16
3.1 SMT Reflow Soldering Instructions .....	16
4. Handling Precautions .....	18
4.1 Handling Precautions.....	18



## 1. Description

### 1.1 General Description

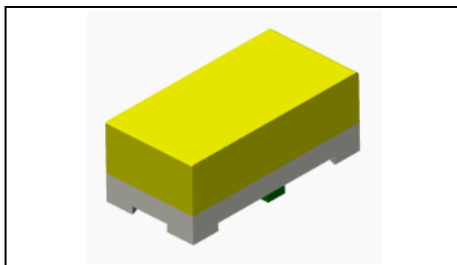

The White LED, which was fabricated by using a blue chip and the phosphor.  
Product Package:1.0mmX0.5mmX0.4mm.

### 1.2 Features

- ▶ Extremely wide viewing angle.
- ▶ Suitable for all SMT assembly and solder process.
- ▶ Moisture sensitivity level: Level 3.
- ▶ RoHS compliant.

### 1.3 Application

- ▶ Optical indicator.
- ▶ Switch and Symbol, Display.
- ▶ Household electrical appliances .
- ▶ General use.



### 1.4 Package Dimension

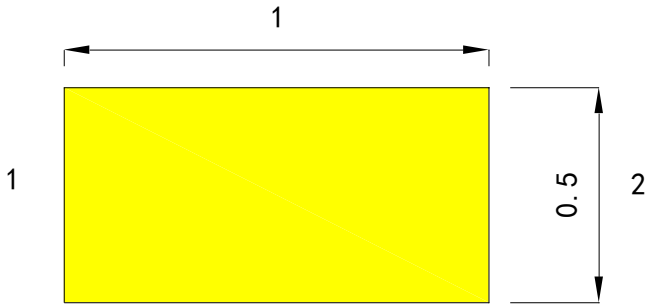

Fig.1-1 Top view

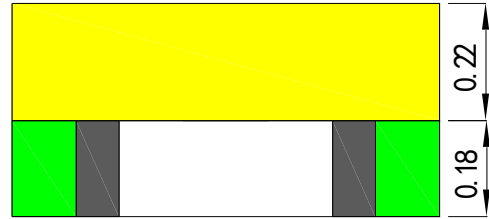

Fig.1-2 Side view

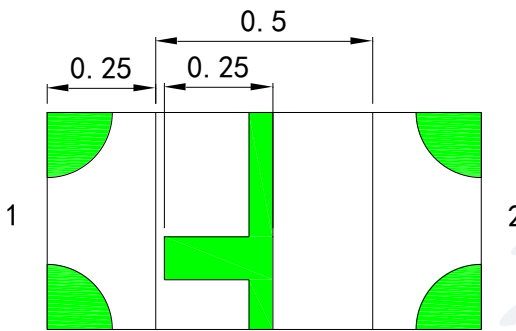

Fig.1-3 Bottom view

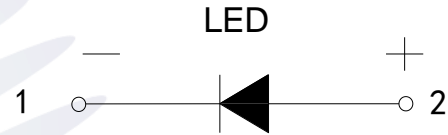

Fig.1-4 Polarity

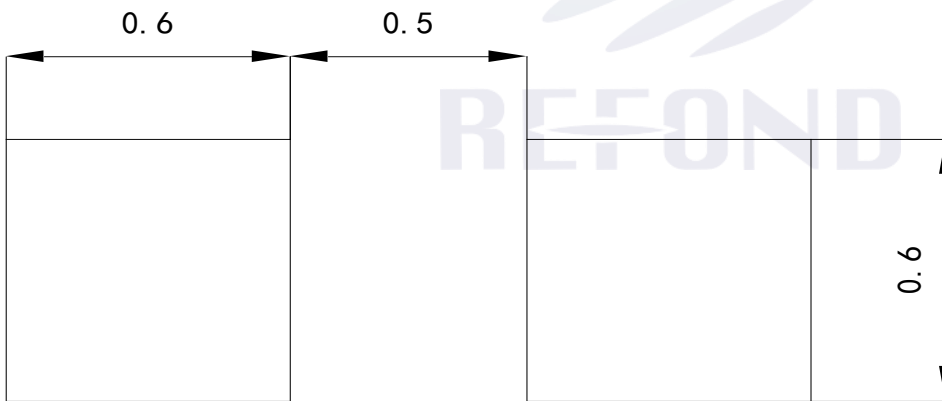

Fig.1-5 Soldering patterns

Notes:

1. All dimensions units are millimeters.
2. All dimensions tolerances are  $\pm 0.2\text{mm}$  unless otherwise noted.



## 1.5 Product Parameters

Table 1-1 Electrical / Optical Characteristics at Ts=25°C

Item	Test Condition	Symbol	Value			Unit	
			Min.	Typ.	Max.		
Forward Voltage	I <sub>F</sub> =5mA	V <sub>F</sub>	E2	2.5	--	2.6	V
			F1	2.6	--	2.7	V
			F2	2.7	--	2.8	V
			G1	2.8	--	2.9	V
			G2	2.9	--	3.0	V
			H1	3.0	--	3.1	V
			H2	3.1	--	3.2	V
			I1	3.2	--	3.3	V
Luminous Intensity	I <sub>F</sub> =5mA	I <sub>v</sub>	H10	150	--	180	mcd
			H20	180	--	230	mcd
			I10	230	--	280	mcd
			I20	280	--	350	mcd
			J10	350	--	430	mcd
Viewing Angle	I <sub>F</sub> =5mA	2θ <sub>1/2</sub>	--	140	--	deg	
Reverse Current	V <sub>R</sub> =5V/10ms	I <sub>R</sub>	--	--	10	μA	
Thermal Resistance.	I <sub>F</sub> =5mA	R <sub>THJ-S</sub>	--	--	450	°C/W	

 Notes: V<sub>R</sub>=5V For test conditions.

Table 1-2 Absolute Maximum Ratings at Ts=25°C

Parameter	Symbol	Rating	Units
Power Dissipation	Pd	66	mW
Forward Current	IF	20	mA
Peak Forward Current Of Pulse	IFP	60	mA
Reverse Voltage	Vr	5	V
Electrostatic Discharge	ESD	1000	V
Operating Temperature	Topr	-40 ~ +85	°C
Storage Temperature	Tstg	-40 ~ +85	°C
Junction Temperature	Tj	95	°C

## Notes:

- 1/10 Duty cycle, 0.1ms pulse width.
- The above forward voltage measurement allowance tolerance is  $\pm 0.1V$ .
- The above color coordinates measurement allowance tolerance is  $\pm 0.005$ .
- The above luminous intensity measurement allowance tolerance  $\pm 10\%$ .
- Care is to be taken that power dissipation does not exceed the absolute maximum rating of the product.
- All measurements were made under the standardized environment of Refond.
- When the LEDs are in operation the maximum current should be decided after measuring the package temperature, junction temperature should not exceed the maximum rate.

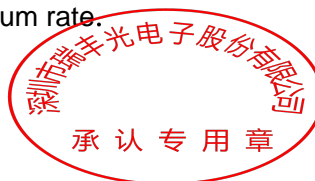

## 1.6 Bin Range Of Forward Voltage and Luminous Flux (IF=5mA)

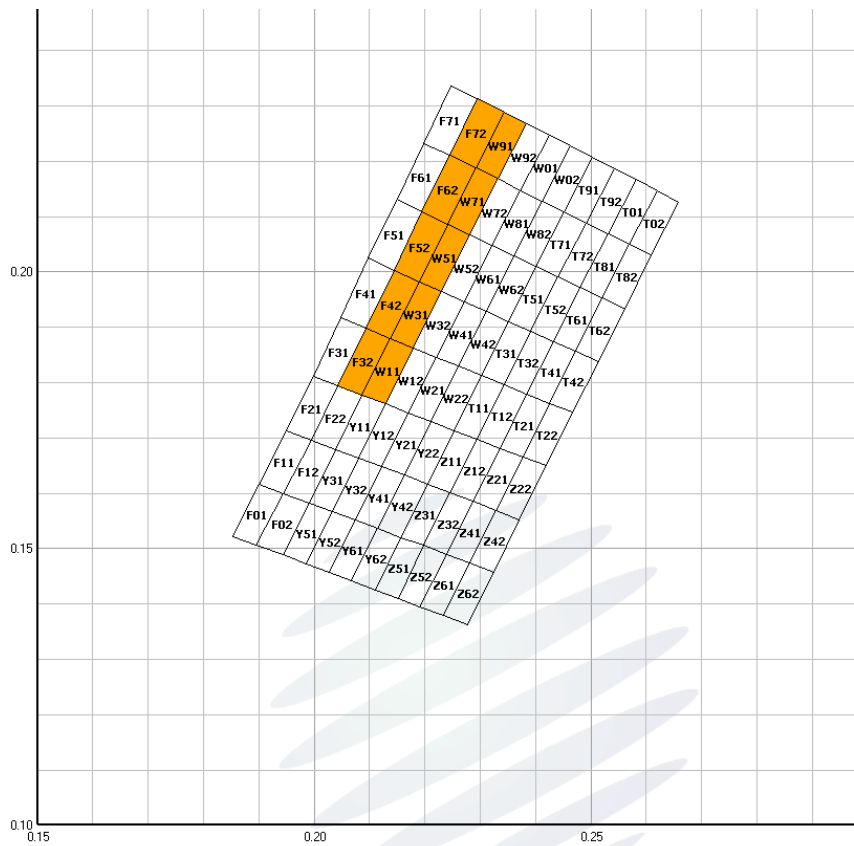

Fig. 1-6 The C.I.E Chromaticity Diagram

Table 1-3 Bin Date

BIN CODE	CIE-X1	CIE-Y1	CIE-X2	CIE-Y2	CIE-X3	CIE-Y3	CIE-X4	CIE-Y4
F32	0.2042	0.1792	0.2086	0.1775	0.2137	0.1878	0.2092	0.1897
F42	0.2092	0.1897	0.2137	0.1878	0.2189	0.1981	0.2143	0.2002
F52	0.2143	0.2002	0.2189	0.1981	0.224	0.2084	0.2194	0.2107
F62	0.2194	0.2107	0.224	0.2084	0.2291	0.2186	0.2244	0.2209
F72	0.2244	0.2209	0.2291	0.2186	0.2342	0.2288	0.2294	0.2312
W11	0.2128	0.176	0.2086	0.1775	0.2137	0.1878	0.2178	0.1861
W31	0.2178	0.1861	0.2137	0.1878	0.2189	0.1981	0.223	0.1963
W51	0.223	0.1963	0.2189	0.1981	0.224	0.2084	0.228	0.2065
W71	0.228	0.2065	0.224	0.2084	0.2291	0.2187	0.2332	0.2167
W91	0.2291	0.2187	0.2332	0.2167	0.2383	0.2267	0.2342	0.2288

### 1.7 Typical Optical Characteristics Curves

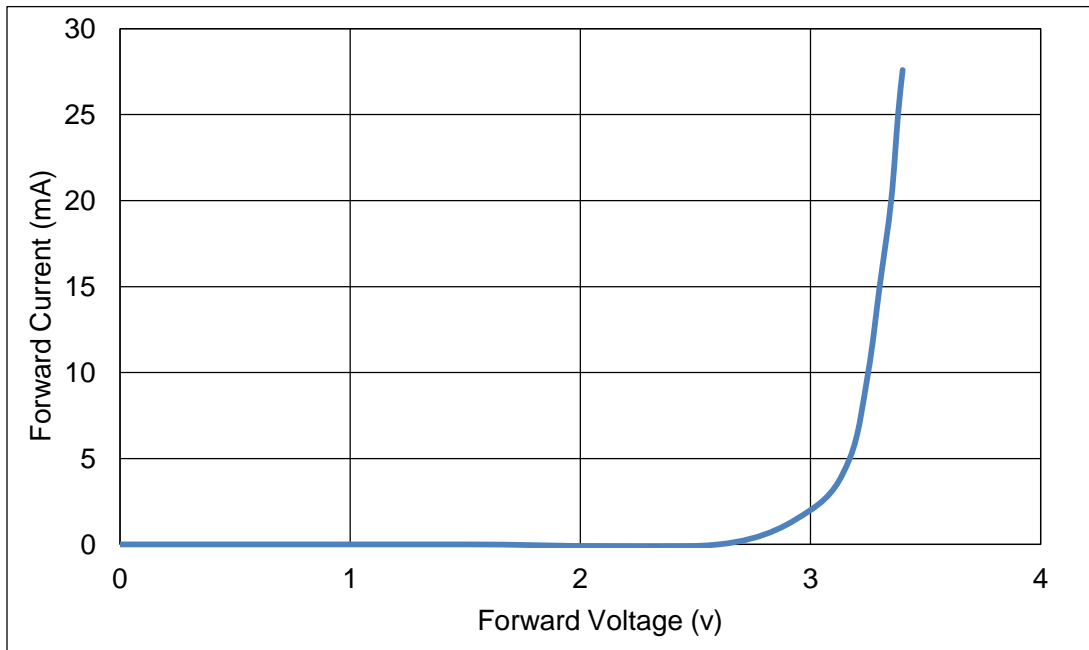

Fig. 1-7 Forward Voltage Vs Forward Current

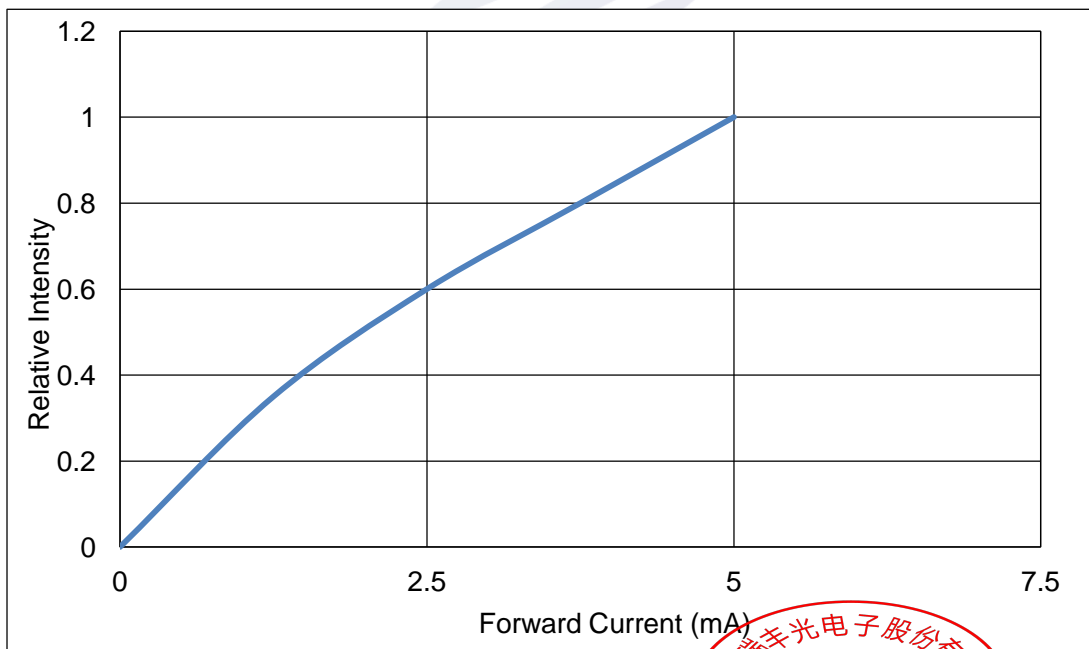

Fig 1-7 Forward Current Vs Relative Intensity





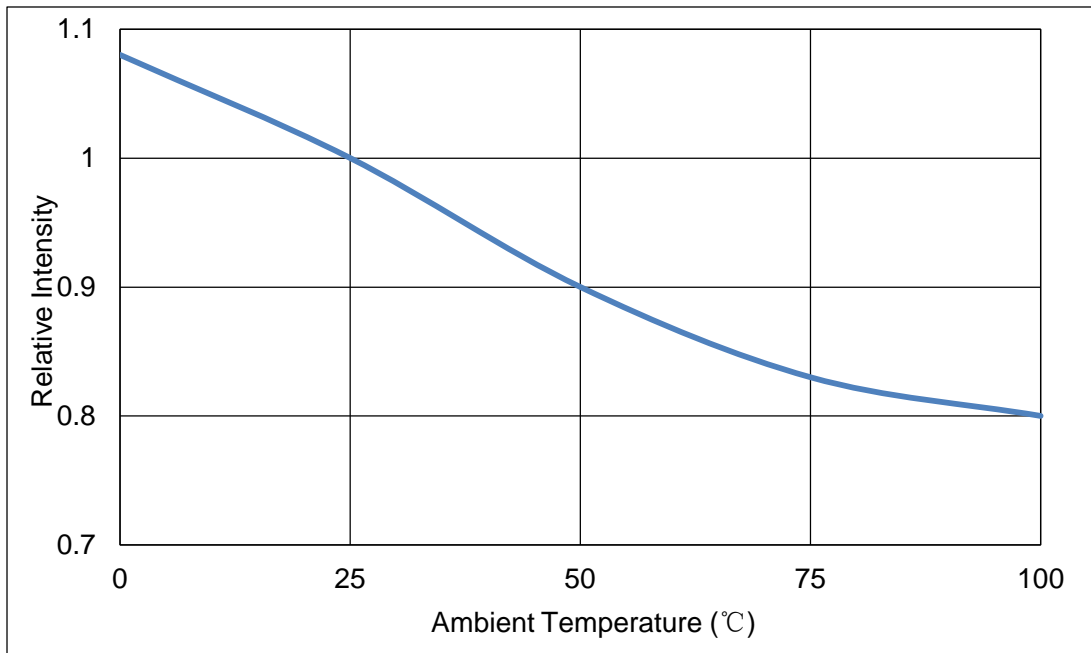

Fig 1-8 Pin Temperature Vs Relative Intensity

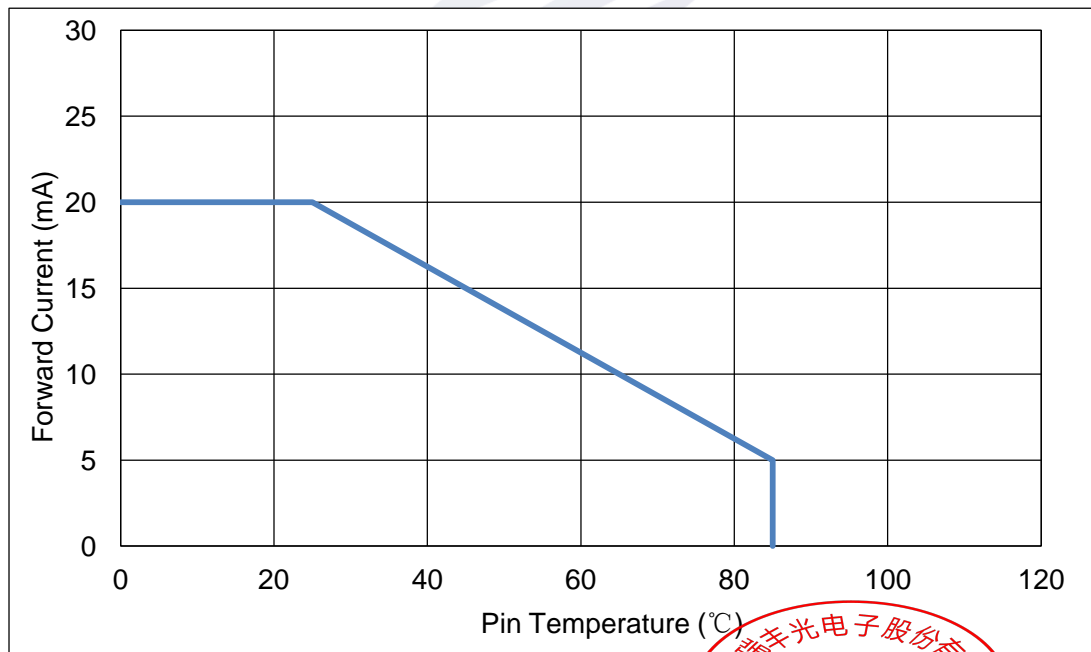

Fig 1-9 Pin Temperature Vs Forward Current



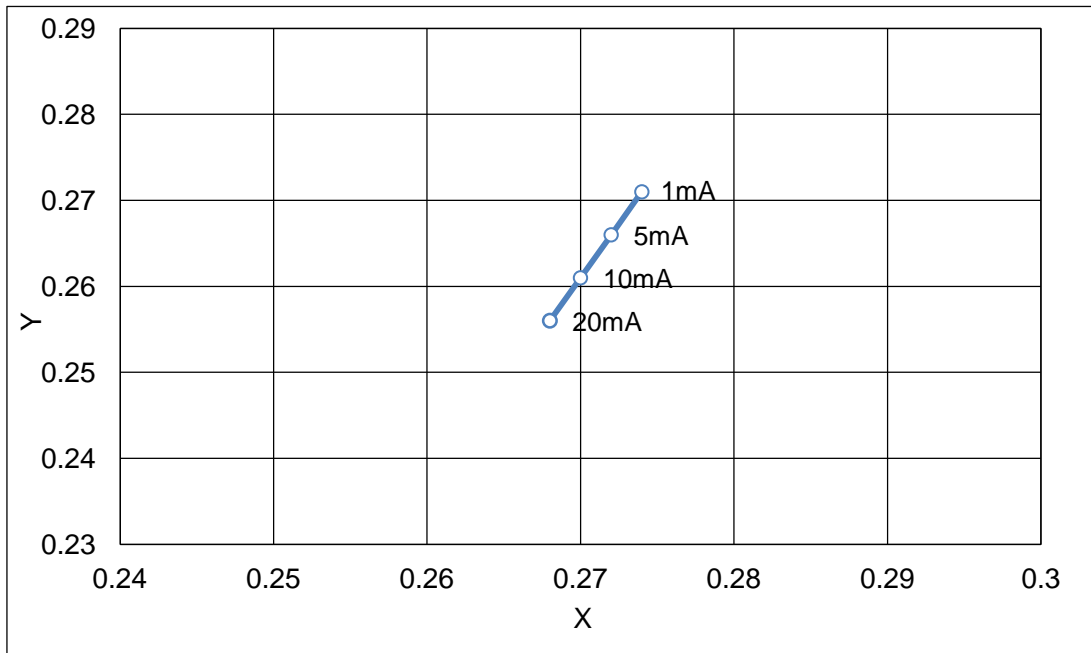

Fig. 1-11 Forward Current Vs Dominate Wavelength (Ta=25°C)

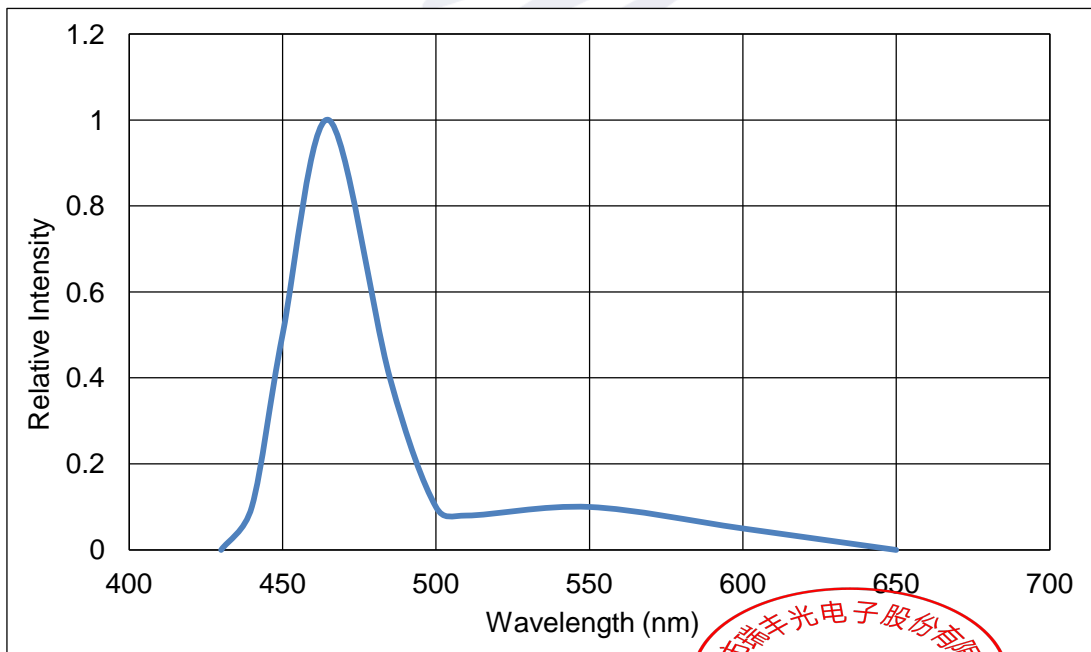
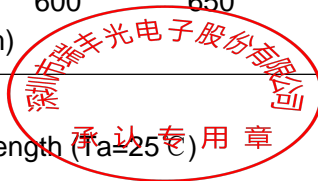

Fig. 1-12 Relative Intensity Vs Wavelength (Ta=25°C)



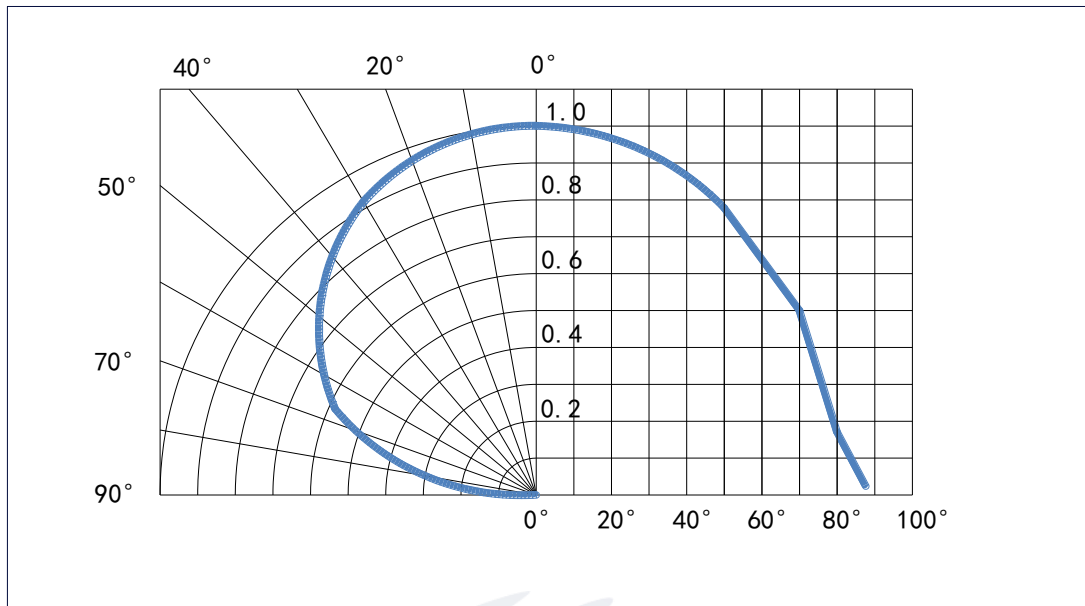

Fig. 1-13 Diagram characteristics of radiation

REFOND



## 2. Packaging

### 2.1 Packaging Specification

Package:4000pcs/reel.

#### 2.1.1 Carrier Tape Dimension

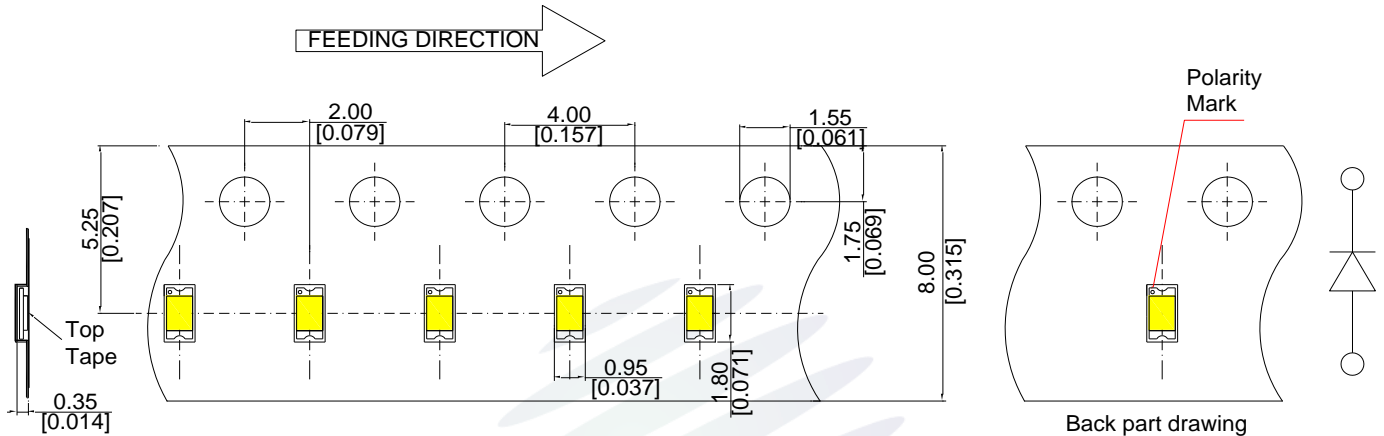

Fig.2-1 Carrier Tape Dimension

#### 2.1.2 Reel Dimension

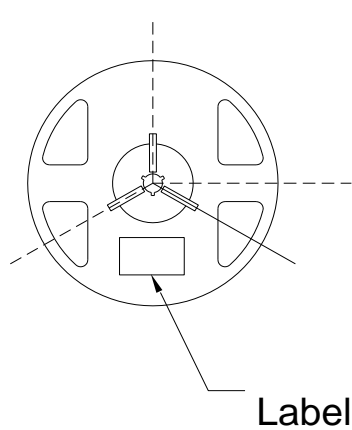

Fig.2-2 Reel Dimension

Table 2-1 Dimension

A	8.0±0.1mm
B	178±1mm
C	60±1mm
D	13.0±0.5mm

Notes:

The tolerances unless mentioned ±0.1mm. Unit : mm



### 2.1.3 Label Form Specification

Table 2-2 Parameter

PART NO:		
SPEC NO:		
LOT NO		
BIN CODE:		
Φ:	XY:	
VF:	WLD:	
	QTY:	
	DATE:	

PART NO.	Part Number
SPEC NO.	Spec Number
LOT NO.	Lot Number
BIN CODE	Bin Code
Φ	Luminous flux
XY	Chromaticity Bin
V <sub>F</sub>	Forward Voltage
WLD	Wavelength
QTY	Packing Quantity
DATE	Made Date

Fig. 2-3 Label Form Specification

### 2.2 Moisture Resistant Packing

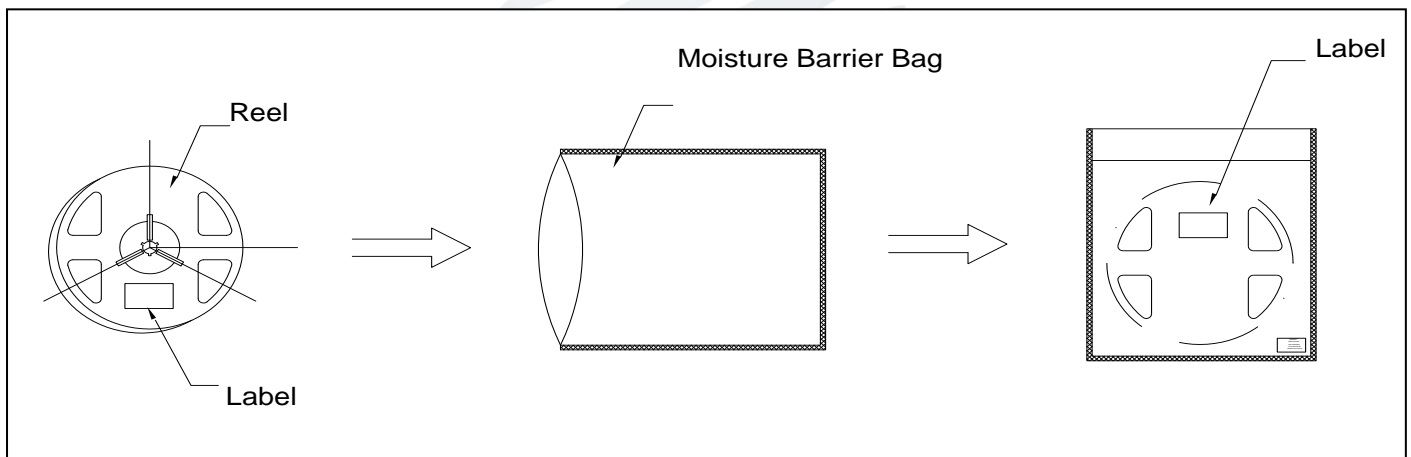

Fig.2-4 Moisture Resistant Packing



## 2.3 Cardboard Box

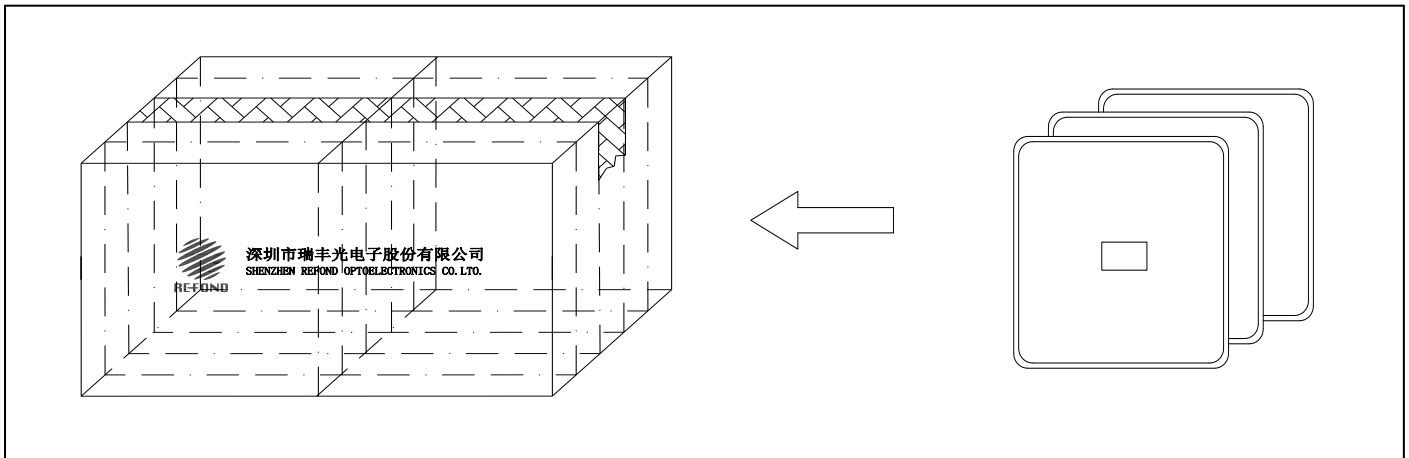
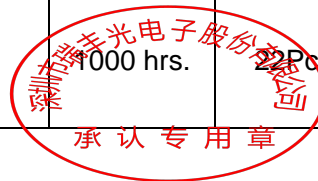

Fig.2-5 Cardboard Box

## 2.4 Reliability Test Items And Conditions

Table 2-3 Reliability Test Items And Conditions

Test Items	Ref.Standard	Test Condition	Time	Quantity	Ac/Re
Reflow	JESD22-B106	Temp:260°Cmax T=10 sec	2 times	22Pcs.	0/1
Temperature Cycle	JESD22-A104	100°C 30 min ↑↓5 min -40°C 30 min	100 cycles	22Pcs.	0/1
Thermal Shock	JESD22-A106	-40°C 15min ↑↓ 100°C 15min	300 cycles	22Pcs.	0/1
High Temperature Storage	JESD22-A103	Temp:100°C	1000 hrs.	22Pcs.	0/1
Low Temperature Storage	JESD22-A119	Temp:-40°C	1000 hrs.	22Pcs.	0/1
Life Test	JESD22-A108	T <sub>a</sub> =25°C I <sub>f</sub> =5mA	1000 hrs.	22Pcs.	0/1



## 2.5 Criteria For Judging Damage

Table 2-4 Criteria For Judging Damage

Test Items	Symbol	Test Condition	Criteria For Judgement	
			Min.	MAX.
Forward Voltage	$V_F$	$I_F=5mA$	-	U.S.L*)x1.1
Reverse Current	$I_R$	$V_R= 5V$	-	U.S.L*)x2.0
Luminous Flux	$\Phi$	$I_F=5mA$	L.S.L*)x0.7	-

Notes:

1.U.S.L: Upper standard level

L.S.L: Lower standard level

2.The above reliability tests is based on the verification of a single/strip LED of Refond's existing experimental platform,the reliability experiment was taken under good heat dissipation conditions. When customers applies the LED to the series and parallel circuit,should take consideration of all the factors such as the current, voltage distribution, heat dissipation and others.

3.The technical information shown in the data sheets is limited to the typical characteristics and circuit examples of the referenced products. It does not constitute the warranting of industrial property nor the granting of any license.



### 3. SMT Reflow Soldering Instructions

#### 3.1 SMT Reflow Soldering Instructions

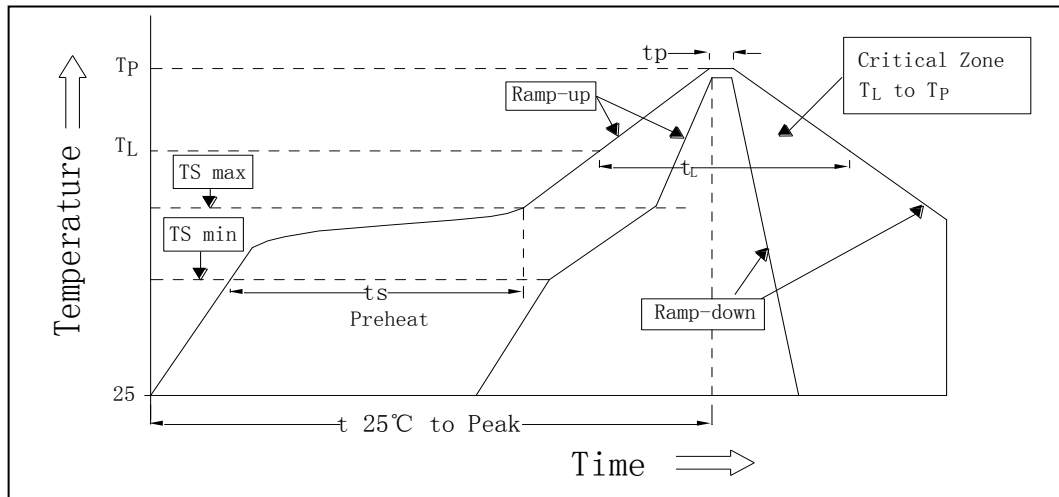
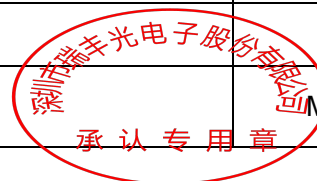

Fig.3-1 SMT Reflow Soldering Instructions

Table 3-1 Parameter

Average temperature rise speed (Tsmax to TP)	Max 3 °C/ s
Preheating: minimum temperature (Tsmín)	150 °C
Preheating: Max temperature (Tsmax)	200 °C
Preheating: Time (Tsmín to Tsmax)	60s-120s
Time limited to maintain high temperature: the temperature (TL)	217 °C
Time limited to maintain high temperature: The Time (tL)	Max 60s
Peak /Classification of temperature: (TP)	260 °C
Time limit classification of peak temperature time (tp)	Max 10s
Hold time within 5 °C with the actual peak temperature (TP)	Max 30s
Cooling speed	Max 6 °C/ s
Needed time from 25 °C to TP	Max 8 minutes





Notes:

(1)Reflow soldering should not be done more than twice. If more than 24 hours between the two solderings , LED will be damaged.

(2)Whensoldering , do not put stress on the LEDs during heating.

### 3.1.1 Soldering Iron

(1) When do soldering by hand, keep the temperature of iron below less 300°C less than 3 seconds.

(2) Soldering by hand should be done only one time.

### 3.1.2 Repairing

Repairing should not be done after the LEDs have been soldered. When repairing is unavoidable,a double-head soldering iron should be used (as below figure). It should be confirmed in advance whether the characteristics of LEDs will or not be damaged by repairing.

### 3.1.3 Cautions

(1) Components should not be mounted on warped (non coplanar) portion of PCB. After soldering, do not warp the circuit board.

(2) Do not apply mechanical force or excess vibration during the cooling process to normal temperature after soldering. Do not rapidly cool device after soldering.



## 4. Handling Precautions

### 4.1 Handling Precautions

- (1) LED operating environment and sulfur element composition cannot be over 100PPM in the LED mating usage material. This is provided for informational purposes only and is not a warranty or endorsement.
- (2) In order to prevent external material from getting into the inside of LED, which may cause the malfunction of LED, the single content of Bromine element is required to be less than 900PPM, the single content of Chlorine element is required to be less than 900PPM, the total content of Bromine element and Chlorine element in the external materials of the application products is required to be less than 1500PPM. This is provided for informational purposes only and is not a warranty or endorsement.
- (3) VOCs (Volatile organic compounds) emitted from materials used in the construction of fixtures can penetrate silicone encapsulants of LEDs and discolor when exposed to heat and photonic energy. The result can be a significant loss of light output from the fixture. Knowledge of the properties of the materials selected to be used in the construction of fixtures can help prevent these issues. Refond advises against the use of any chemicals or materials that have been found or are suspected to have an adverse effect on device performance or reliability. To verify compatibility, Refond recommends that all chemicals and materials be tested in the specific application and environment for which they are intended to be used. Attaching LEDs, do not use adhesives that outgas organic vapor.
- (4) In designing a circuit, the current through each LED can not exceed the absolute maximum rating specified for each LED. In the meanwhile, resistors for protection should be applied, otherwise slight voltage shift will cause big current change, burn out may happen. The driving circuit must be designed to allow forward voltage only when it is ON or OFF. If the reverse voltage is applied to LED, migration can be generated resulting in LED damage.
- (5) Thermal Design is paramount importance because heat generation may result in the characteristics decline, such as brightness decreased, color change and so on. Please consider the heat generation of the LEDs when making the system design.

## (6) Storage

Table 4-1 Storage

Conditions		Temperature	Humidity	Time
Storage	Before Opening Aluminum Bag	$\leq 30^{\circ}\text{C}$	$\leq 75\%$	Within 1 Year From Date
	After Opening Aluminum Bag	$\leq 30^{\circ}\text{C}$	$\leq 60\%$	168hours
Baking		$60 \pm 5^{\circ}\text{C}$	-	$\geq 24$ hours

(7) If the moisture absorbent material ( silica gel ) has faded away or the LEDs have exceeded the storage time , baking treatment should be performed after unpacking and based on the following condition (  $60 \pm 5$  )  $^{\circ}\text{C}$  for above 24 hours.

If the package is flatulence or damaged, please notify the sales staff to assist.

(8) Similar to most Solid state devices; LEDs are sensitive to Electro-Static Discharge (ESD) and Electrical Over Stress (EOS).

(9) Other points for attention, please refer to our relevant information.







## X-ON Electronics

Largest Supplier of Electrical and Electronic Components

*Click to view similar products for [Standard LEDs - SMD category](#):*

*Click to view products by [REFOND manufacturer](#):*

Other Similar products are found below :

[LTST-C190KYKT](#) [LTST-C19GD2WT](#) [LTST-N683GBEW](#) [LTW-170ZDC](#) [LTW-M140SZS40](#) [598-8110-100F](#) [598-8170-100F](#) [598-8610-202F](#) [91-21SURC/S530-A3/TR10](#) [AAAF5060QBFSEEZGS](#) [ALMD-LB36-SV002](#) [APT1608QGW](#) [EAST2012YA0](#) [EASV1803BA0](#) [91-21UYC/S530-A3/TR10](#) [LG M67K-H1J2-24-0-2-R18-Z](#) [SML-512VWT86A](#) [SML-LX0606SISUGC/A](#) [SML-LXL1307SRC-TR](#) [SML-LXR851SIUPGUBC](#) [LT1ED53A](#) [AM27ZGC03](#) [APB3025SGNC](#) [APFA3010SURKCGKQBDC](#) [APHK1608VGCA](#) [APT2012QGW](#) [CLX6D-FKB-CN1R1H1BB7D3D3](#) [LTST-008BGEW](#) [LTST-C250KGKT](#) [LTW-010DCG](#) [LTW-020ZDCG](#) [LTW-21TS5](#) [LTW-220DS5](#) [42-21UYC/S530-A3/TR8](#) [598-8330-117F](#) [SML-LX0402IC-TR](#) [CMDA20AYAA7D1S](#) [CMDA16AYDR7A1X](#) [91-21SYGD/S530-E2/TR7](#) [598-8040-100F](#) [598-8070-100F](#) [598-8140-100F](#) [598-8610-200F](#) [EAST2012GA0](#) [EAPL3527GA5](#) [SML-LXL1209SYC/ATR](#) [EAST2012RA0](#) [EAST1608RGBAO](#) [LTW-008RGB2-PH1](#) [CMD91-21VRC/TR7](#)