

Benefits of the new



Five colours for an easier identification of coil voltage



red:
230 Vac (North America 120 Vac)



AC

dark red:
others Vac



grey:
Vac/dc



dark blue:
others Vdc



DC

blue
24 Vdc

If you don't want to have the lockable function, you can use the orange "dead-man-push-button".
SO-OP for MR-C and S9-OP for QR-C (5 pieces bag)



"Dead-man-push-button"

A black blanking plug is available if you don't want a test button.
SO-NP for MR-C and S9-NP for QR-C (5 pieces bag)



Blanking plug

Comprehensive technical label

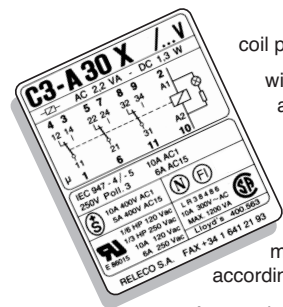

coil power

wiring diagram with sequential and DIN numbers

electric diagram showing all additions to the coil

maximum switching capacity according to EN 60947 (IEC 947)

Approvals

Push-to-Test-Pull-to-Lock button (PTPL)

Coil voltage marked on the top face of the relay

Marking label

Double window for the mechanical identification

LED

LED

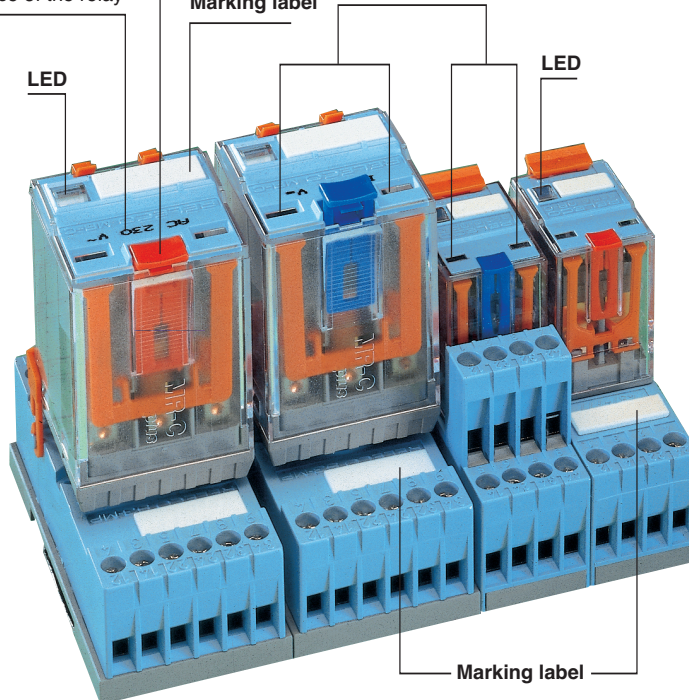

Marking label

Approvals

Country	Approval	Country	Approval
Canada	Authority: CSA Specification: C22.2; UL 508	Switzerland	Authority: SEV Specification: EN 60 947 (IEC 947)
Denmark	Authority: DEMKO Specification: EN 60 947 (IEC 947)	United Kingdom	Authority: Lloyd's Register of Shipping Specification: ENV1 ENV2
Finland	Authority: SETI Specification: EN 60 947 (IEC 947)		
Norway	Authority: NEMKO Specification: EN 60 947 (IEC 947)	USA	Authority: UL Specification: UL 508 C22.2
Sweden	Authority: SEMKO Specification: EN 60 947 (IEC 947)		

Application	Types		Poles	AC ratings	DC ratings	Page	Sockets	Page
General purpose	C2-A20	Universal 8 pin, standard	2 C	10A / 250V	0,5A @ 110V	7	S2	18
	C3-A30	Universal 11 pin, standard	3 C	10A / 250V	0,5A @ 110V	8	S3	19, 20
	C4-A40	Square base, 4 pole	4 C	10A / 250V	0,5A @ 110V	11	S4	21
	C5-A20	Square base AC power	2 C	16A / 500V	0,5A @ 110V	12	S5	22
	C5-A30	Square base AC power	3 C	16A / 500V	0,5A @ 110V	12	S5	22
	C7-A10	Miniature AC power	1 C	16A / 250V	0,5A @ 110V	14	S7	22, 23
	C7-A20	Miniature AC power	2 C	10A / 250V	0,5A @ 110V	14	S7	22, 23
	C9-A41	Miniature, 14 pin plug-in	4 C	5A / 250V	0,2A @ 110V	16	S9	23
	Twin contacts Low level loads	C2-T21	Universal 8 pin, plug-in	2 C	6A / 250V	Min. 1mA @ 5V	7	S2
C3-T31		Universal 11 pin, plug-in	3 C	6A / 250V	Min. 1mA @ 5V	8	S3	19, 20
C7-T21		Miniature	2 C	6A / 250V	Min. 1mA @ 5V	14	S7	22, 23
Open contacts DC load switching Flag not available	C2-G20	Universal 8 pin, plug-in	2 NO	10A / 250V	1,2A @ 110V	7	S2	18
	C3-G30	Universal 11 pin, plug-in	3 NO	10A / 250V	1,2A @ 110V	8	S3	19, 20
	C5-G30	Square base	3 NO	16A / 500V	1,2A @ 110V	12	S5	22
	C7-G20	Miniature	2 NO	10A / 250V	0,8A @ 110V	15	S7	22, 23
Double make DC load switching Flag not available	C3-X10	11 pin, plug-in DC power	1 DM	10A / 250V	7A @ 110V	9	S3	19, 20
	C4-X20	Square base DC power	2 DM	10A / 250V	7A @ 110V	11	S4	21
	C5-X10	Square base DC power	1 DM	10A / 250V	7A @ 110V	13	S5	22
	C7-X10	Miniature DC power	1 DM	10A / 250V	6A @ 110V	15	S7	22, 23
Magnet blow-out Flag not available	C3-M10	11 pin High DC load	1 DM	10A / 250V	10A @ 220V	9	S3	19, 20
	C5-M10	Square base. High DC load	1 DM	16A / 500V	10A @ 220V	13	S5	22
Latching LED not available	C3-R20	11 pin plug-in	2 C	10A / 250V	0,5A @ 110V	9	S3	19, 20
	C4-R30	Square base, 14 pin	3 C	10A / 250V	0,5A @ 110V	11	S4	21
	C5-R20	Square base	2 C	10A / 250V	0,5A @ 110V	13	S5	22
	C9-R21	Miniature	2 C	5A / 250V	0,2A @ 110V	16	S9	23
Sensitive 250mW ... 800mW Flag not available	C3-S14	Universal 11 pin plug-in	1 C	6A / 250V	0,5A @ 110V	10	S3	19, 20
	C3-E24	Universal 11 pin plug-in	2 C	6A / 250V	0,5A @ 110V	10	S3	19, 20
	C3-N34	Universal 11 pin plug-in	3 C	6A / 250V	0,5A @ 110V	10	S3	19, 20
	C9-E21	Miniature	2 C	5A / 250V	0,2A @ 110V	16	S9	23
Lamp switching	C7-W10	Miniature, faston 187	1 NO	10A / 250V	0,5A @ 110V	15	S7	22, 23
Time cube	CT2	8 pin plug-in timer module	2 C	10A / 250V	0,5A @ 110V	17	S2	18
	CT3	11 pin plug-in timer module	3 C	10A / 250V	0,5A @ 110V	17	S3	19, 20

Part number key

C3-A30 DX / AC230V

Model series

- C2 - MR-C universal 8 pin
- C3 - MR-C universal 11 pin
- C4 - MR-C square base 4-pole
- C5 - MR-C square base, power
- C7 - QR-C miniature, power
- C9 - QR-C miniature 4-pole

Type

- A - standard, change-over contacts
- T - twin contacts (bifurcated)
- G - open contacts
- X - double make contacts
- M - double make, magnetic blow out
- R - remanence (latching)
- S - sensitive coil, 250 mW
- E - sensitive coil, 500 mW
- N - sensitive coil, 800 mW
- W - tungsten and silver contacts

Coil voltage

Additions to the coil

- X - LED (Not for latching)
- D - free wheeling diode (DC only)
- F - polarity and free wheeling diodes
- B - rectifying bridge for AC/DC relays
- R - RC suppressor (only MR-C types)

Special executions

- P - pins for printed circuit
- E - cover for flange panel mounting

Contact materials

- 0 - standard
- 9 - gold-flashed contact, 0,2µ Au (only MR-C Types)
- 8 - gold-plated contact, 10µ Au (only MR-C Types)
- 4 - sensitive MRC relays
- 2 - gold-plated 10µ Au (twin and C9 relays)
- 1 - flashed 0,2µ Au (twin and C9 relays)

Number of contacts

Contact materials

Silver-nickel (AgNi) and silver-tin oxide (AgSnO₂) are used as standard contact materials for all models. Other contact materials are available on request.

Gold Flash

For relays that are intended to be stored or remain unoperated for any length of time, a 0,2µ layer of gold protects the contacts from oxidisation.

Gold Plating

A 10µ plate of gold increases the operational reliability. They should be used for switching low level currents.

Contact Resistance

Contact resistance is dependent on contact material, contact pressure and contact contamination.

High contact resistance raises the temperature of the contacts, therefore reducing their working life.

Typical contact resistance of the MR-C and QR-C relays is 50 mΩ.

Contacts gap

Contact gap and opening speed of the contacts have an influence on the length and the duration of the arc.

In the case of AC, a gap of 0,5 mm is sufficient to quench the arc which occurs automatically at the “zero point” of the cycle.

In the case of DC, the arc only quenches when the contact gap is sufficient for the voltage and current applied.

Please see tables of “Max. DC current”.

Coil Materials

Coils bobbins are moulded in polybutylene with fibreglass (130° C).

Enamelled wires of Class F specification are used (155° C).

They are wound on automatic precision winding machines, with the number of turns and wire tension accurately regulated and monitored.

Tolerances

Coil resistance is measured at 20° C and is regulated within ± 10% of specified value.

Standard Windings

The coil voltages indicated in the catalogue refer to standard windings.

Other coil voltages are available, including products for series connection and amperometric applications.

Please consult your distributor for details.

Maximum Intensity

The “Max. switching current” indicated in every model, refers to the maximum stable current which should be possible in permanent conduction (I_{TH}).

In the case of AC, the “Max. switching-current” that the relay can support is the same for all the values of voltages ≤ of the “Max. switching voltage” specified in every model.

The product of the intensity and the voltage applied should not be higher than the values specified as “Max. AC load”.

In the case of DC, the “Max. switching current” must be less than the current that causes the continuous arcing.

The tables of “Max. DC current” show the possible values of intensity in relation to the applied voltage.

Maximum Voltage

The maximum voltage on the contacts depends on the insulation between each contact (pole to pole) and between all contacts and the coil.

The EN60947 and VDE 0110 standards set out the maximum voltage values, taking into consideration the quality of the insulation materials, pollution degree as well as the shape and dimensions of the contact barriers (creepage distance).

Contacts in series

The connection of two or more contacts in series is equivalent to multiplying the contact gap by that amount. By using this method, a greater break capacity is achieved for DC switching.

Minimum working voltage (pull in)

This is the minimum voltage that must be supplied to the coil to ensure that the relay energises, the contacts change over and are positively held in place without any vibration.

The values of voltage specified are those at or below which the relay must pull in.

working at:	50 Hz	60 Hz
AC 50 Hz Relays	0,8xU _N	0,85xU _N
AC 60 Hz Relays	0,75xU _N	0,8xU _N
DC Relays	0,8xU _N	

Maximum release voltage (drop out)

This is the voltage at which the relay de-energises, the contacts change over and are positively held in place without any vibration.

The values of voltage specified are those at or above which the relay must drop out.

DC relays ≥ 10% U_N
AC relays ≥ 15% U_N

Contacts in parallel

The connection of two or more contacts in parallel does not mean that it is possible to switch a greater load. However, the stable current and the operational reliability of the relay is increased.

Double make contacts

The double make contact arrangement is equivalent to two contacts connected in series.

The maximum intensity supported corresponds to only one contact. This system allows for higher DC operating voltages.

Bifurcated (twin) contacts

The contact blade is divided into two parts, each with its own contact. Both contacts press down each on their own independent fixed contacts.

This system is particularly good for reliably switching at very low levels.

Contact protection

The electrical life of contacts can be prolonged by components which eliminate or reduce the back EMF transients.

These voltages are generated by the reactive component of the load on disconnection, which increases the duration and the temperature of the arc.

For AC, RC suppressors or varistors can be connected in parallel with the load or the contacts.

For DC with an inductive load, the best method is to connect a diode in parallel with the load.

Ambient temperature

The ambient temperature has an influence on the coil resistance and on its thermal dissipation capacity.

Curve 1 represents the variations of the pull in voltage (% U_N) in relation with the ambient temperature (T).

Curve 2 indicates the maximum values of the voltage applied (U_b) to the coil in relation with the nominal voltage (U_N) at the ambient temperature (T).

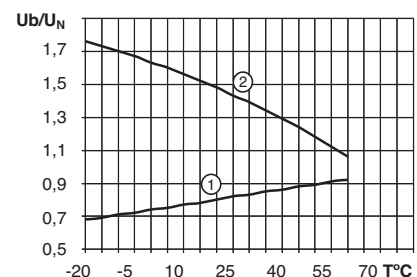

A General purpose relays
They are used for most general applications, like as automation, pneumatic, heating appliances, signaling, as an input or output interface, etc.

Change-over contacts. Isolation between NO/NC: 1000 Vrms. Gap: 0,5 mm.
Rating loads of up to 16A @ 230V AC1
16 A @ 30V DC1
0,5A @ 110V DC1 0,2A @ 220V DC1

MR-C coils C2-A20 and C3-A30

Vac	Ω	mA	Vdc	Ω	mA
24	67	92	12	110	110
48	296	46	24	443	54
115	1K7	19	48	1K8	27
230	7K1	9,5	110	9K2	12
400*	18K1	5,5	220	36K1	6

* 400V coils only in pollution 2

MR-C coils C4-A40, C5-A20, C5-A30

Vac	Ω	mA	Vdc	Ω	mA
24	65	100	12	105	116
48	286	50	24	414	58
115	1K7	21	48	1K6	30
230	6K8	10	110	8K1	13
400*	18K8	6	220	35K7	6,2

* C4-A40 , 400V coils only in pollution 2

QR-C coils C7-A20, C9-A41

Vac	Ω	mA	Vdc	Ω	mA
24	174	50	12	148	85
48	686	25	24	594	43
115	4K3	10,4	48	2K3	21
230	18K6	5,2	110	11K4	9,1

T Relays with twin contacts
These are used to switch low currents with high operational reliability.

Change-over contacts. Isolation between contacts NO/NC: 1000 Vrms.
Gap: 0,5 mm
Gold-flashed contact 0,2μ or plated with 10μ Au (optional).

Maximum load: 6A @ 230V AC1
Minimum load: 1 mA @ 5V DC1

MR-C coils C2-T21 and C3-T31

Vac	Ω	mA	Vdc	Ω	mA
24	67	92	12	110	110
48	296	46	24	443	54
115	1K7	19	48	1K8	27
230	7K1	9,5	110	9K2	12
400*	18K1	5,5	220	36K1	6

* 400V coils only in pollution 2

QR-C coils C7-T21

Vac	Ω	mA	Vdc	Ω	mA
24	153	62	12	148	85
48	611	31	24	594	43
115	3K6	13	48	2K3	21
230	14K6	6,5	110	11K4	9,1

G Relays with open contacts
An open contact arrangement allows an increase in the contact gap, increasing the DC “break capacity” without altering the AC performance.

Gap: 1,5 mm (QR-C types); 1,7 mm (MR-C)
Isolation of contacts NO: >2000 Vrms.

Maximum load: 16A @ 230V AC1
1,2A @ 110V DC1 0,4A @ 220V DC1

MR-C coils C2-G20, C3-G30, C5-G30

Vac	Ω	mA	Vdc	Ω	mA
24	65	100	12	90	133
48	286	50	24	373	66
115	1K7	21	48	1K4	34
230	6K8	10	110	7K6	15
400*	18K8	6	220	30K3	7,5

* C2-G20, C3-G30 400V only in pollution 2

QR-C coils C7-G20

Vac	Ω	mA	Vdc	Ω	mA
24	143	75	12	99	121
48	579	38	24	388	61
115	3K4	15	48	1K5	30
230	13K5	8	110	8K	13

X Double make relays
These relays are designed to switch high DC loads at voltages of 110 and 220 Vdc.

They consist of one normally open contact with a gap >3 mm so that the arc length is divided by two.

Isolation between contacts: >2000 Vrms
The max. DC load is shown in the tables.
X versions are available in MR-C and QR-C type housing.

MR-C coils C3-X10, C4-X20, C5-X10 (see M version)

QR-C coil C7-X10

Vac	Ω	mA	Vdc	Ω	mA
24	143	75	12	111	108
48	579	38	24	432	55
115	3K4	15	48	1K7	27
230	13K5	8	110	9K2	12

M Relays with “mag. blow out”
These versions are similar to X types, however they have an addition of a powerful magnet which “blows out” the arc generated when the contacts are opened, therefore quenching the arcing quickly and increasing the contact life.

They are able to switch DC loads of up to 10A @ 220V DC1 and 2A @ 220V DC13

MR-C coils C3-M10, C5-M10 and C3-X10, C4-X20, C5-X10

Vac	Ω	mA	Vdc	Ω	mA
24	65	100	12	110	110
48	286	50	24	443	54
115	1K7	21	48	1K8	27
230	6K8	10	110	9K2	12
400*	18K8	6	220	36K1	6

* C3-M10, C3-X10 and C4-X20 400V coils only in pollution 2

R Remanence relays
A high remanence magnetic circuit allows the relay to latch positively when the current applied flows through the coil in a direction and delatches if the current flows in the opposite direction.

Electronic circuitry is added inside the relay to control this action and also protects against transient voltages.

There is one winding for AC coils and two windings for DC coils.
All coils withstand permanent connection.
The relay can be operated with pulses of 50 ms., minimum, at nominal voltage.

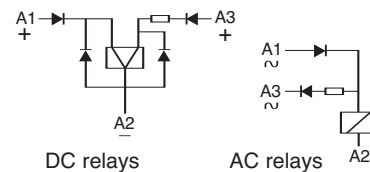

MR-C coils C3-R20, C4-R30, C5-R20

Vac	ON		OFF		Vdc	ON		OFF			
	mA	mA	mA	mA		mA	mA				
24	75	12	12	125	41	12	66	21			
48	38	6	24	66	21	48	31	10			
115	16	2,5	48	31	10	230	8	1,3	110	14	4,5

QR-C coils C9-R21

Vac	ON		OFF		Vdc	ON		OFF			
	mA	mA	mA	mA		mA	mA				
24	50	8	12	100	50	48	25	25			
48	25	4	24	50	25	115	10	2	48	25	12,5
230	5	1	60	20	10						

S Sensitive relays, 250 mW
One change-over contact

E Sensitive relays, 500 mW
Two change-over contacts

N Sensitive relays, 800 mW
Three change-over contacts

DC relays adjusted to work at lower power, available in both MR-C and QR-C versions. Gold-flashed contacts 0,2µ or plated 10µ Au (optional).

Operational voltage range:

S relays: 0,8 ... 2,5 U_N

E relays: 0,8 ... 1,7 U_N

N relays: 0,8 ... 1,4 U_N

Coils Relays C3-S, C3-E, C3-N, C9-E

Vdc	Relays S		Relays E		Relays N	
	Ω	mA	Ω	mA	Ω	mA
6	144	42	72	83	45	133
12	536	21	288	42	180	66
24	2K2	10	1K1	21	720	33
48	8K6	5	4K6	10	2K8	17
60			7K2	8,3	4K5	13
110			21K2	5	15K	7

W High inrush current relay
Two open contacts, one of silver nickel and one of tungsten work in parallel but are physically displaced so that the tungsten contact makes and breaks the load. The silver contact is used for carrying the stable current.

This relay was designed to switch incandescent and fluorescent lamps, (with p.f corrected), and DC inductive loads.

Only available in **C7** type housing.

Maximum loads:

6A @ 230 AC5a/b (lamps)

10A @ 230V AC15; 1,5A @ 110V DC1

See table of electrical life on page 15.

QR-C coils

Relays C7-W

Vac	Ω	mA	Vdc	Ω	mA
24	143	75	12	99	121
48	579	38	24	388	61
115	3K4	15	48	1K5	30
230	13K5	8	110	8K	13

Specifications

The data referred to in the specifications for each model refers to typical values of "new" relays at 20° C.

Tables

The tables of electrical life and the tables of maximum DC current show the typical result of exhaustive tests performed at an ambient temperature of 20° C, operating frequency of 1200 operations / hour, and under permanent connection.

The switching current ratings specified in the catalogue refer to a minimum electrical life of 100.000 operations.

Margin of over-voltage

Coils withstand, on permanent connection, a maximum over-voltage of 110% U_N , with rated current through the contacts at an ambient temperature of 60° C.

Custom relays

Relays with special specifications can be supplied after consultation with an official Releco distributor.

Protection against transients

When the coil is disconnected from an electromagnet, peaks of inverse voltage appear at the terminals which can reach very high values. These pulses can be transmitted down the line associated with the coil and could possibly affect other components.

In the case of a relay being operated by such devices as transistors, triacs, etc; it may be necessary to protect against transients.

Transients carried in the line

High voltage surges can be carried in the supply line to the relay coil. These may appear in the form of peaks or bursts and are generated by the connection and disconnection of electric motors, transformers, capacitors etc.

Normally a relay is unaffected by these pulses, but if a diode is connected in association with the coil, it must be capable of withstanding an inverse voltage higher than those of the incoming peaks.

Protection circuits

A protection circuit must efficiently cope with pulses generated by the coil as well as incoming line surges (surges $U_{1,2/50\mu s}$). Releco relays are available with integrated protection circuits or with modules plugged into sockets S3-MP or S3-MS.

X LED indication with rectifier.
For DC and AC relays up to 250V
Surges of 1000V up to 24V
Surges of 2000V from 25 to 60V
Surges of 4000V from 61 to 250V
Note: LED connected in series with the coil @ 220Vdc in QRC types.

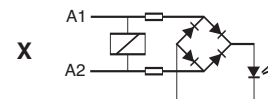

LED consumption: 1mA

D Free wheeling diode.
DX Free wheeling diode + LED
Dampens transients caused by the relay coil on de-energisation.
Surges of 2000V up to 60 Vdc
Surges of 4000V from 61 to 250 Vdc (*)

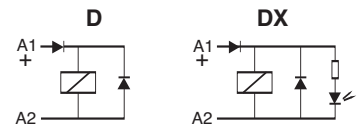

Increase release time approx. 4 times

F Polarity and free wheeling diodes.
FX Polarity + free wheeling diode + LED
A diode in series with the coil protects the relay from reverse connection.
Surges of 1000V up to 60 Vdc
Surges of 4000V from 61 to 250 Vdc (*)

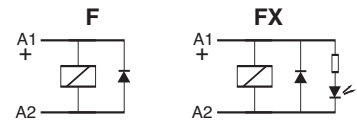

Increase release time approx. 4 times

B Bridge rectifier incorporated.
BX Bridge rectifier + LED indication
Allows the relay to operate in both AC or DC without any polarity inconvenience.
Available only in voltages up to 60V
Surges of 1000V

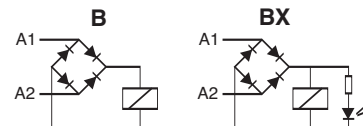

Increase release time approx. 3 times

R Resistor and capacitor.
Suppressor for AC coils. Surges of 2000V
Available only in **MRC** types

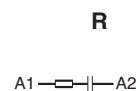

(*) Surges of 2000V in **QRC** types.

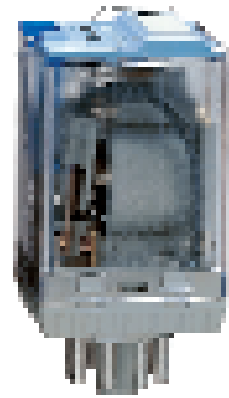

C2-A20... General purpose
Two change-over contacts, 10 A

10A / 250V AC1 10A @ 30V DC1
6A / 250V AC15 0,5A @ 110V DC1

Contacts

Materials code **0** (standard); options: 8 - 9
Max. switching current 10 A
Peak inrush current (20 ms) 30 A
Max. switching voltage, (pollution 3) 250 V
Max. switching voltage, (pollution 2) 400 V
Max. AC load (Table 1) 2,5 KVA
Max. DC load See Table 2

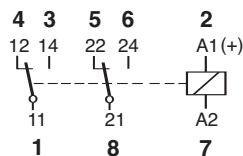

Standard types (50/60 Hz and DC)

AC 24, 48, 115 (110 ... 120), **230**
X = LED **C2-A20** X/ ... V
RC suppressor **C2-A20R** / ... V

DC 12, 24, 48, 110, 120/125, 220
X = LED **C2-A20** X/ ... V
Free wheeling diode **C2-A20D** X/ ... V
Free wheeling and polarity **C2-A20F** X/ ... V
AC/DC rectifier (60V max.) **C2-A20B** X/ ... V

Specifications

Nominal coil power: 2,2 VA (AC), 1,3 W (DC)
Operate time 16 ms.
Release time 8 ms.
Isolation: EN60947 pollution 3, Gr C 250V
Dielectric strength, contacts / coil 2,5 KV
Dielectric strength, pole / pole 2,5 KV



Dimensions (mm)

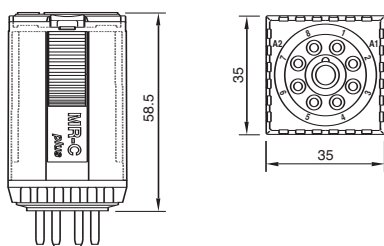

C2-T21... Low level
Two change-over, bifurcated contacts

6A / 250V AC1 6A @ 30V DC1
Min. 1mA @ DC 5V

Contacts

Materials code **1** (standard); option: 2
Switching current: min. 1 mA; max. 6 A
Peak inrush current (5 ms) 15 A
Max. switching voltage, (pollution 3) 250 V
Max. switching voltage, (pollution 2) 400 V
Max. AC load (Table 3) 1,2 KVA
Max. DC load See Table 18, pag. 14

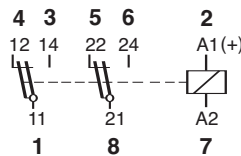

Standard types (50/60 Hz and DC)

AC 24, 48, 115 (110 ... 120), **230**
X = LED **C2-T21** X/ ... V
RC suppressor **C2-T21R** / ... V

DC 12, 24, 48, 110, 120/125, 220
X = LED **C2-T21** X/ ... V
Free wheeling diode **C2-T21D** X/ ... V
Free wheeling and polarity **C2-T21F** X/ ... V
AC/DC rectifier (60V max.) **C2-T21B** X/ ... V

Specifications

Nominal coil power: 2,2 VA (AC), 1,3 W (DC)
Operate time 16 ms.
Release time 8 ms.
Isolation: EN60947 pollution 3, Gr C 250V
Dielectric strength, contacts / coil 2,5 KV
Dielectric strength, pole / pole 2,5 KV



Table 1 Electrical life (ops x 10⁶)
C2-A, C2-G, C3-A, C3-G, C3-R, C5-R

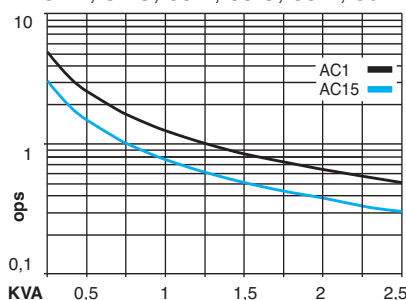

C2-G20... General purpose, DC
Two open contacts

10A / 250V AC1 0,3A @ 110V DC13
1,2A @ 110V DC1 0,4A @ 220V DC1

Contacts

Materials code **0** (standard)
Max. switching current 10 A
Peak inrush current (20 ms) 30 A
Max. switching voltage, (pollution 3) 250 V
Max. switching voltage, (pollution 2) 400 V
Max. AC load (Table 1) 2,5 KVA
Max. DC load See Table 4, pag. 8

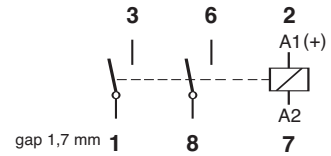

Standard types (50/60 Hz and DC)

AC 24, 48, 115 (110 ... 120), **230**
X = LED **C2-G20** X/ ... V
RC suppressor **C2-G20R** / ... V

DC 12, 24, 48, 110, 120/125, 220
X = LED **C2-G20** X/ ... V
Free wheeling diode **C2-G20D** X/ ... V
Free wheeling and polarity **C2-G20F** X/ ... V
AC/DC rectifier (60V max.) **C2-G20B** X/ ... V

Specifications

Nominal coil power: 2,4 VA (AC), 1,6 W (DC)
Operate time 20 ms.
Release time 10 ms.
Isolation: EN60947 pollution 3, Gr C 250V
Dielectric strength, contacts / coil 2,5 KV
Dielectric strength, pole / pole 2,5 KV



Table 2 Max. DC load
C2-A, C3-(A, R), C4-(A, R), C5-R, C7-A

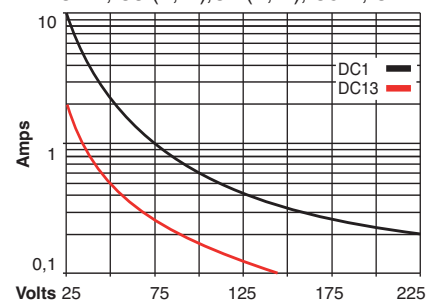



C3-A30... General purpose Three change-over contacts, 10 A

10A / 250V AC1 10A @ 30V DC1
6A / 250V AC15 0,5A @ 110V DC1

Contacts

Materials code **0** (standard); options: 8 - 9
Max. switching current 10 A
Peak inrush current (20 ms) 30 A
Max. switching voltage, (pollution 3) 250 V
Max. switching voltage, (pollution 2) 400 V
Max. AC load (Table 1, pag.7) 2,5 KVA
Max. DC load See Table 2, pag. 7

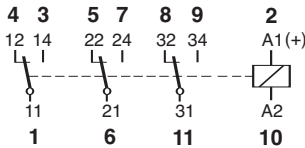

Standard types (50/60 Hz and DC)

AC 24, 48, 115 (110 ... 120), 230
X = LED **C3-A30** X/ ... V
RC suppressor **C3-A30R** / ... V

DC 12, 24, 48, 110, 120/125, 220
X = LED **C3-A30** X/ ... V
Free wheeling diode **C3-A30D** X/ ... V
Free wheeling and polarity **C3-A30F** X/ ... V
AC/DC rectifier (60V max.) **C3-A30B** X/ ... V

Specifications

Nominal coil power: 2,2 VA (AC), 1,3 W (DC)
Operate time 16 ms.
Release time 8 ms.
Isolation: EN60947 pollution 3, Gr C 250V
Dielectric strength, contacts / coil 2,5 KV
Dielectric strength, pole / pole 2,5 KV

C3-T31... Low level 3 change-over, bifurcated contacts

6A / 250V AC1 6A @ 30V DC1
Min. 1mA @ DC 5V

Contacts

Materials code **1** (standard); option: 2
Switching current: min. 1 mA, max. 6 A
Peak inrush current (15 ms) 15 A
Max. switching voltage, (pollution 3) 250 V
Max. switching voltage, (pollution 2) 400 V
Max. AC resistive load (Table 3) 1,2 KVA
Max. DC load See Table 18, pag. 14

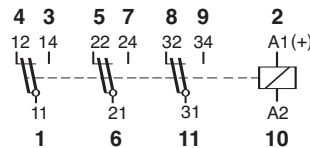

Standard types (50/60 Hz and DC)

AC 24, 48, 115 (110 ... 120), 230
X = LED **C3-T31** X/ ... V
RC suppressor **C3-T31R** / ... V

DC 12, 24, 48, 110, 120/125, 220
X = LED **C3-T31** X/ ... V
Free wheeling diode **C3-T31D** X/ ... V
Free wheeling and polarity **C3-T31F** X/ ... V
AC/DC rectifier (60V max.) **C3-T31B** X/ ... V

Specifications

Nominal coil power: 2,2 VA (AC), 1,3 W (DC)
Operate time 16 ms.
Release time 8 ms.
Isolation: EN60947 pollution 3, Gr C 250V
Dielectric strength, contacts / coil 2,5 KV
Dielectric strength, pole / pole 2,5 KV

C3-G30... General purpose, DC Three open contacts

10A / 250V AC1 0,3A @ 110V DC13
1,2A @ 110V DC1 0,4A @ 220V DC1

Contacts

Materials code **0** (standard)
Max. switching current 10 A
Peak inrush current (20 ms) 30 A
Max. switching voltage, (pollution 3) 250 V
Max. switching voltage, (pollution 2) 400 V
Max. AC load (Table 1, pag. 7) 2,5 KVA
Max. DC load See Table 4

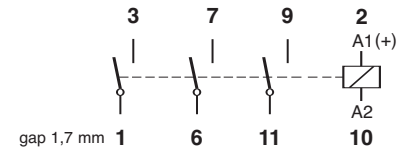

Standard types (50/60 Hz and DC)

AC 24, 48, 115 (110 ... 120), 230
X = LED **C3-G30** X/ ... V
RC suppressor **C3-G30R** / ... V

DC 12, 24, 48, 110, 120/125, 220
X = LED **C3-G30** X/ ... V
Free wheeling diode **C3-G30D** X/ ... V
Free wheeling and polarity **C3-G30F** X/ ... V
AC/DC rectifier (60V max.) **C3-G30B** X/ ... V

Specifications

Nominal coil power: 2,4 VA (AC), 1,6 W (DC)
Operate time 20 ms.
Release time 10 ms.
Isolation: EN60947 pollution 3, Gr C 250V
Dielectric strength, contacts / coil 2,5 KV
Dielectric strength, pole / pole 2,5 KV



Dimensions (mm)

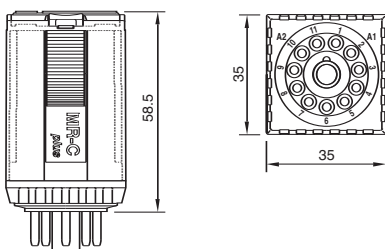

Table 3 Electrical life (ops x 10⁶)
Types C2-T21, C3-T31, C7-T21

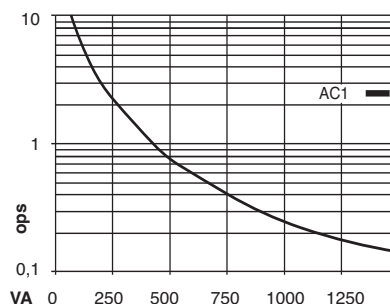
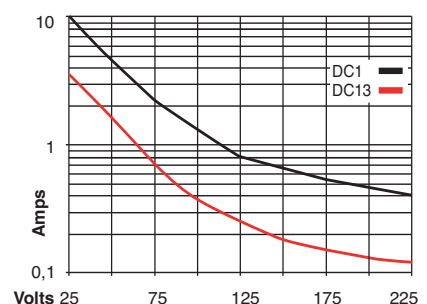
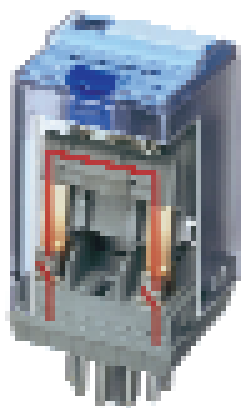

Table 4 Max. DC load
Types C2-G20, C3-G30





C3-X10... Power relay, DC
Single pole, NO, double make

10A / 250V AC1	1,2A @ 220V DC1
7A @ 110V DC1	0,3A @ 220V DC13

C3-M10... Power relay, DC
Single pole, magnetic blow out

10A / 250V AC1	10A @ 220V DC1
3,6A @ 110V DC13	2A @ 220V DC13

C3-R20... Latching
Two change-over contacts, 10 A

10A / 250V AC1	10A @ 30V DC1
6A / 250V AC15	0,5A @ 110V DC1

Contacts

Materials code 0 (standard)
Max. switching current 10 A
Peak inrush current (20 ms) 30 A
Max. switching voltage, (pollution 3) 250 V
Max. switching voltage, (pollution 2) 400V
Max. AC load (Table 5) 2,5 KVA
Max. DC load See Table 10, pag. 11

Contacts

Materials code 0 (standard)
Max. switching current. 10 A
Peak inrush current (20 ms) 30 A
Max. switching voltage, (pollution 3) 250 V
Max. switching voltage, (pollution 2) 400 V
Max. AC load (Table 5) 2,5 KVA
Electrical life, DC See Tables 6 and 7

Contacts

Materials code 0 (standard); options: 8 - 9
Max. switching current 10 A
Peak inrush current (20 ms) 30 A
Max. switching voltage, (pollution 3) 250 V
Max. switching voltage, (pollution 2) 400 V
Max. AC load (Table 1, pag. 7) 2,5 KVA
Max. DC load See Table 2, pag. 7

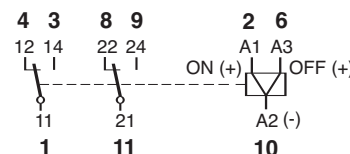
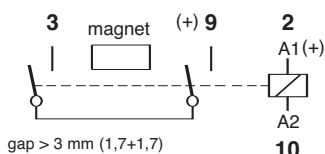
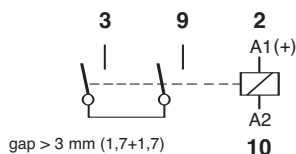

Standard types (50/60 Hz and DC)

AC 24, 48, 115 (110 ... 120), 230
X = LED C3-X10 X/ ... V
RC suppressor C3-X10R / ... V

DC 12, 24, 48, 110, 120/125, 220
X = LED C3-X10 X/ ... V
Free wheeling diode C3-X10D X/ ... V
Free wheeling and polarity C3-X10F X/ ... V
AC/DC rectifier (60V max.) C3-X10B X/ ... V

Specifications

Nominal coil power: 2,4 VA (AC), 1,3 W (DC)
Operate time 20 ms.
Release time 10 ms.
Isolation: EN60947 pollution 3, Gr C 250V
Dielectric strength, contacts / coil 2,5 KV

Standard types (50/60 Hz and DC)

AC 24, 48, 115 (110 ... 120), 230
Standard types (50/60 Hz and DC)
AC 24, 48, 115 (110 ... 120), 230
X = LED C3-M10 X/ ... V
RC suppressor C3-M10R / ... V

DC 12, 24, 48, 110, 120/125, 220
X = LED C3-M10 X/ ... V
Free wheeling diode C3-M10D X/ ... V
Free wheeling and polarity C3-M10F X/ ... V
AC/DC rectifier (60V max.) C3-M10B X/ ... V

Specifications

Nominal coil power: 2,4 VA (AC), 1,3 W (DC)
Operate time 20 ms.
Release time 10 ms.
Isolation: EN60947 pollution 3, Gr C 250V

Standard types (50/60 Hz and DC)

AC 24, 48, 115 (110 ... 120), 230
C3-R20 / ... V
DC 12, 24, 48, 110, 125
(two windings) C3-R20 / ... V

Note: All AC and DC coils withstand permanent connection.

Specifications

ON pulse power 1,5 VA/ W
OFF pulse power 0,5 VA/ W
Min. pulse length for ON/OFF control 50 ms.
Isolation: EN60947 pollution 3, Gr C 250V
Dielectric strength, contacts / coil 2,5 KV
Dielectric strength, pole / pole 2,5 KV



Table 5 Electrical life (ops x 10⁶)
Types C3-X10 and C3-M10

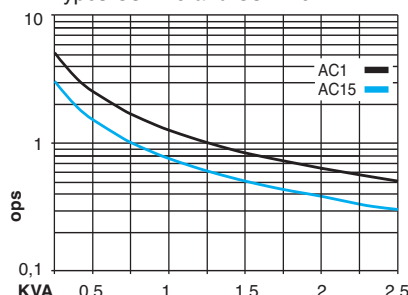

Table 6 Electrical life (ops x 10⁶)
Types C3-M10 and C5-M10

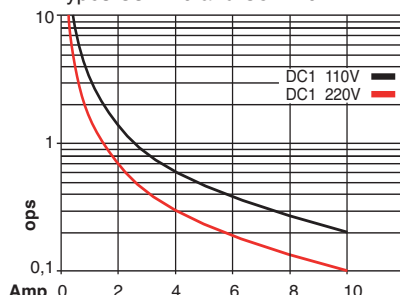
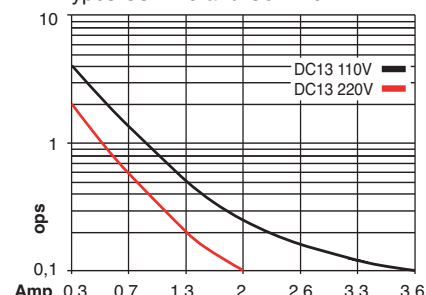
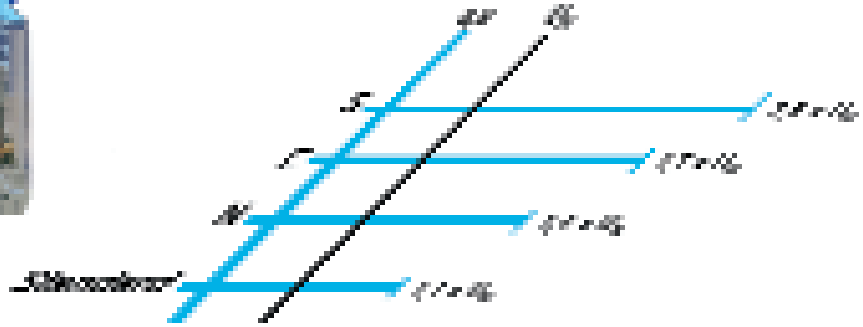

Table 7 Electrical life (ops x 10⁶)
Types C3-M10 and C5-M10





C3-S14... Sensitive, 250 mW One change-over contact, 6 A

Operating range: 0,8 ... 2,5 x U_N
6A / 250V AC1 6A @ 30V DC1

Contacts

Materials code 4 (standard)
Max. switching current 6 A
Peak inrush current (10 ms) 15 A
Max. switching voltage, (pollution 3) 250 V
Max. switching voltage, (pollution 2) 400 V
Max. AC resistive load (Table 8) 1,2 KVA
Max. DC load See Table 9

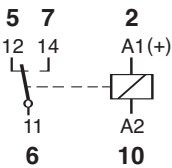

Standard types, DC

DC 6, 12, 24, 48

C3-S14 / ... V

Free wheeling diode C3-S14D / ... V
Free wheeling and polarity C3-S14F / ... V

Note: The connection of diodes to the coil will increase the initial drop-out time.
LED available only on request, see pag. 6

Specifications

Nominal coil power 250 mW
Operate time 18 ms.
Release time 10 ms.
Isolation: EN60947 pollution 3, Gr C 250V
Dielectric strength, contacts / coil 2,5 KV
Dielectric strength, pole / pole 2,5 KV



Dimensions (mm)

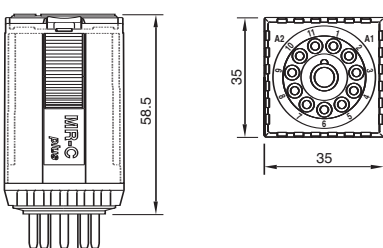

C3-E24... Sensitive, 500 mW Two change-over contacts, 6 A

Operating range: 0,8 ... 1,7 x U_N
6A / 250V AC1 6A @ 30V DC1

Contacts

Materials code 4 (standard)
Max. switching current 6 A
Peak inrush current (10 ms) 15 A
Max. switching voltage, (pollution 3) 250 V
Max. switching voltage, (pollution 2) 400 V
Max. AC resistive load (Table 8) 1,2 KVA
Max. DC load See Table 9

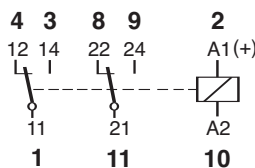

Standard types, DC

DC 6, 12, 24, 48, 60, 110

C3-E24 / ... V

Free wheeling diode C3-E24D / ... V
Free wheeling and polarity C3-E24F / ... V

Note: The connection of diodes to the coil will increase the initial drop-out time.
LED available only on request, see pag. 6

Specifications

Nominal coil power 500 mW
Operate time 18 ms.
Release time 10 ms.
Isolation: EN60947 pollution 3, Gr C 250V
Dielectric strength, contacts / coil 2,5 KV
Dielectric strength, pole / pole 2,5 KV



Table 8 Electrical life (ops x 10⁶)
Types C3-S14, C3-E24, C3-N34

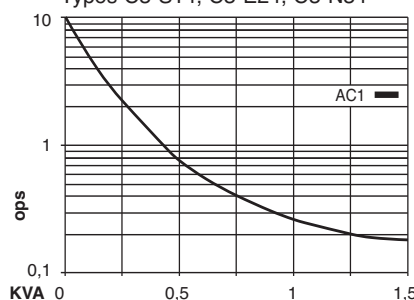

C3-N34... Sensitive, 800 mW Three change-over contacts, 6 A

Operating range: 0,8 ... 1,4 x U_N
6A / 250V AC1 6A @ 30V DC1

Contacts

Materials code 4 (standard)
Max. switching current 6 A
Peak inrush current (10 ms) 15 A
Max. switching voltage, (pollution 3) 250 V
Max. switching voltage, (pollution 2) 400 V
Max. AC resistive load (Table 8) 1,2 KVA
Max. DC load See Table 9

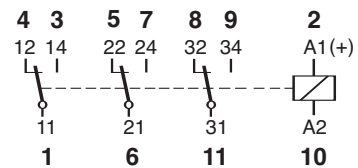

Standard types, DC

DC 6, 12, 24, 48, 60, 110

C3-N34 / ... V

Free wheeling diode C3-N34D / ... V
Free wheeling and polarity C3-N34F / ... V

Note: The connection of diodes to the coil will increase the initial drop-out time.
LED available only on request, see pag. 6

Specifications

Nominal coil power 800 mW
Operate time 18 ms.
Release time 10 ms.
Isolation: EN60947 pollution 3, Gr C 250V
Dielectric strength, contacts / coil 2,5 KV
Dielectric strength, pole / pole 2,5 KV



Table 9 Max. DC load
Types C3-S14, C3-E24, C3-N34

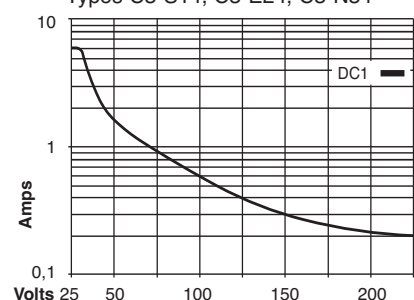

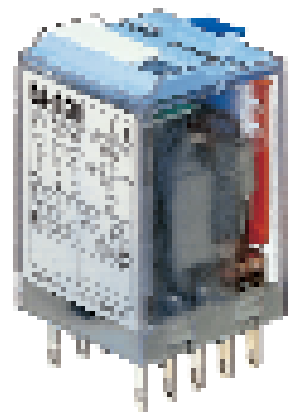
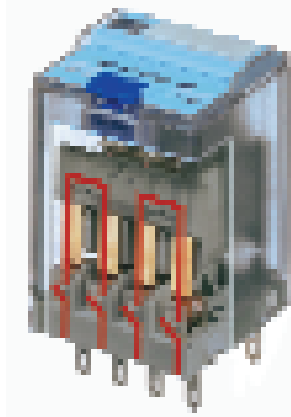

C4-A40... General purpose Four change-over contacts, 10 A

10A / 250V AC1 10 A @ 30V DC1
6A / 250V AC15 0,5A @ 110V DC1

Contacts

Materials code **0** (standard); options: 8 - 9
Max. switching current 10 A
Peak inrush current (20 ms) 30 A
Max. switching voltage, (pollution 3) 250 V
Max. switching voltage, (pollution 2) 400 V
Max. AC load (Table 11) 2 KVA
Max. DC load See Table 2, pag. 7

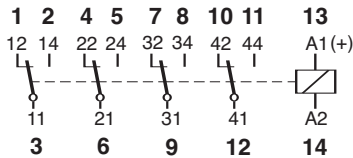

Standard types (50/60 Hz and DC)

AC 24, 48, 115 (110 ... 120), 230
X = LED C4-A40 X/ ... V
RC suppressor C4-A40R / ... V

DC 12, 24, 48, 110, 120/125, 220
X = LED C4-A40 X/ ... V
Free wheeling diode C4-A40D X/ ... V
Free wheeling and polarity C4-A40F X/ ... V
AC/DC rectifier (60V max.) C4-A40B X/ ... V

Specifications

Nominal coil power: 2,4 VA (AC), 1,4 W (DC)
Operate time 20 ms.
Release time 8 ms.
Isolation: EN60947 pollution 3, Gr C 250V
Dielectric strength, contacts / coil 2,5 KV
Dielectric strength, pole / pole 2,5 KV

Lloyd's

Dimensions (mm)

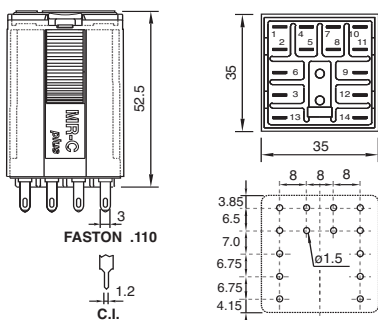

C4-X20... Power relay, DC Double pole, NO, double make

10A / 250V AC1 1,2A @ 220V DC1
7A @ 110V DC1 0,3A @ 220V DC13

Contacts

Materials code **0** (standard)
Max. switching current 10 A
Peak inrush current (20 ms) 30 A
Max. switching voltage, (pollution 3) 250 V
Max. switching voltage, (pollution 2) 400 V
Max. AC load (Table 11) 2 KVA
Max. DC load See Table 10

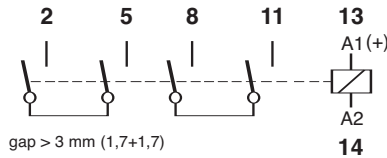

Standard types (50/60 Hz and DC)

AC 24, 48, 115 (110 ... 120), 230
X = LED C4-X20 X/ ... V
RC suppressor C4-X20R / ... V

DC 12, 24, 48, 110, 120/125, 220
X = LED C4-X20 X/ ... V
Free wheeling diode C4-X20D X/ ... V
Free wheeling and polarity C4-X20F X/ ... V
AC/DC rectifier (60V max.) C4-X20B X/ ... V

Specifications

Nominal coil power: 2,4 VA (AC), 1,3 W (DC)
Operate time 20 ms.
Release time 8 ms.
Isolation: EN60947 pollution 3, Gr C 250V
Dielectric strength, contacts / coil 2,5 KV
Dielectric strength, pole / pole 2,5 KV

Table 10 Max. DC load
Type C3-X10, C4-X20

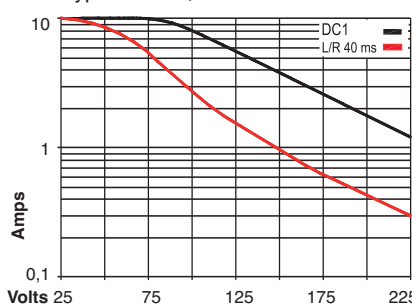

C4-R30... Latching relay Three change-over contacts, 10 A

10A / 250V AC1 10 A @ 30V DC1
6A / 250V AC15 0,5A @ 110V DC1

Contacts

Materials code **0** (standard); options: 8 - 9
Max. switching current 10 A
Peak inrush current (20 ms) 30 A
Max. switching voltage, (pollution 3) 250 V
Max. switching voltage, (pollution 2) 400 V
Max. AC load (Table 11) 2 KVA
Max. DC load See Table 2, pag. 7

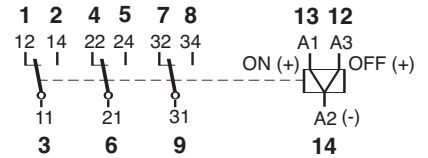

Standard types (50/60 Hz and DC)

AC 24, 48, 115 (110 ... 120), 230
C4-R30 / ... V

DC 12, 24, 48, 110, 125
Two coils C4-R30 / ... V

Note: All AC and DC coils withstand permanent connection.

Specifications

ON pulse power 1,5 VA/ W
OFF pulse power 0,5 VA/ W
Min. pulse length for ON/OFF control: 50 ms.
Isolation: EN60947 pollution 3, Gr C 250V
Dielectric strength, contacts / coil 2,5 KV
Dielectric strength, pole / pole 2,5 KV

Table 11 Electrical life (ops x 10⁶)
Types C4-A40, C4-X20, C4-R30

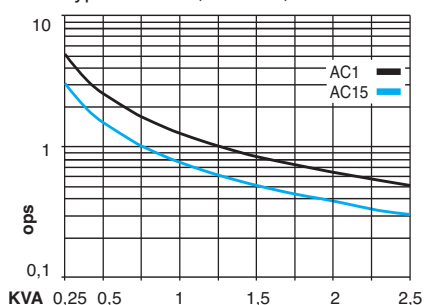



C5-A20... General purpose Two change-over contacts, 16 A

16A / 500V AC1 16A @ 30V DC1
8A / 500V AC15 0,5A @ 110V DC1

Contacts

Materials code **0** (standard); options: 8 - 9
Max. switching current 16 A
Peak inrush current (20 ms) 40 A
Max. switching voltage, (pollution 3) 500
Max. AC load (Table 12) 4 KVA
Max. DC load See Table 13

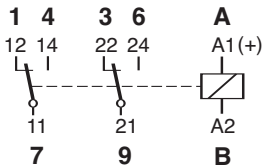

Standard types (50/60 Hz and DC)

AC 24, 48, 115 (110 ... 120), 230, 400
X = LED C5-A20 X/ ... V
RC suppressor C5-A20R / ... V

DC 12, 24, 48, 110, 120/125, 220
X = LED C5-A20 X/ ... V
Free wheeling diode C5-A20D X/ ... V
Free wheeling and polarity C5-A20F X/ ... V
AC/DC rectifier (60V max.) C5-A20B X/ ... V

Specifications

Nominal coil power: 2,4 VA (AC), 1,4 W (DC)
Operate time 20 ms.
Release time 10 ms.
Isolation: EN60947 pollution 3, Gr C 500 V
Dielectric strength, contacts / coil 4 KV
Dielectric strength, pole / pole 4 KV

C5-A30... General purpose Three change-over contacts, 16 A

16A / 500V AC1 16A @ 30V DC1
8A / 500V AC15 0,5A @ 110V DC1

Contacts

Materials code **0** (standard); options: 8 - 9
Max. switching current 16 A
Peak inrush current (20 ms) 40 A
Max. switching voltage, (pollution 3) 500
Max. AC load (Table 12) 4 KVA
Max. DC load See Table 13

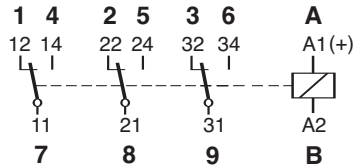

Standard types (50/60 Hz and DC)

AC 24, 48, 115 (110 ... 120), 230, 400
X = LED C5-A30 X/ ... V
RC suppressor C5-A30R / ... V

DC 12, 24, 48, 110, 120/125, 220
X = LED C5-A30 X/ ... V
Free wheeling diode C5-A30D X/ ... V
Free wheeling and polarity C5-A30F X/ ... V
AC/DC rectifier (60V max.) C5-A30B X/ ... V

Specifications

Nominal coil power: 2,4 VA (AC), 1,4 W (DC)
Operate time 20 ms.
Release time 10 ms.
Isolation: EN60947 pollution 3, Gr C 500 V
Dielectric strength, contacts / coil 4 KV
Dielectric strength, pole / pole 4 KV

C5-G30... General purpose, DC Three open contacts

16A / 500V AC1 0,3A @ 110V DC13
1,2A @ 110V DC1 0,4A @ 220V DC1

Contacts

Materials code **0** (standard)
Max. switching current 16 A
Peak inrush current (20 ms) 40 A
Max. switching voltage, (pollution 3) 500 V
Max. AC load (Table 12) 4 KVA
Max. DC load See Table 14, pag. 13

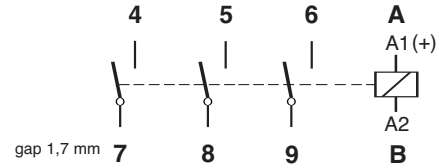

Standard types (50/60 Hz and DC)

AC 24, 48, 115 (110 ... 120), 230, 400
X = LED C5-G30 X/ ... V
RC suppressor C5-G30R / ... V

DC 12, 24, 48, 110, 120/125, 220
X = LED C5-G30 X/ ... V
Free wheeling diode C5-G30D X/ ... V
Free wheeling and polarity C5-G30F X/ ... V
AC/DC rectifier (60V max.) C5-G30B X/ ... V

Specifications

Nominal coil power: 2,4 VA (AC), 1,6 W (DC)
Operate time 20 ms.
Release time 10 ms.
Isolation: EN60947 pollution 3, Gr C 500 V
Dielectric strength, contacts / coil 4 KV
Dielectric strength, pole / pole 4 KV



Dimensions (mm)

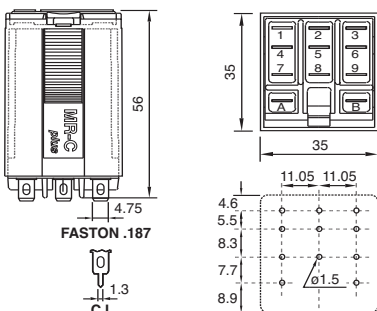

Table 12 Electrical life (ops x 10⁶)
Types C5- (A, G, X, M)

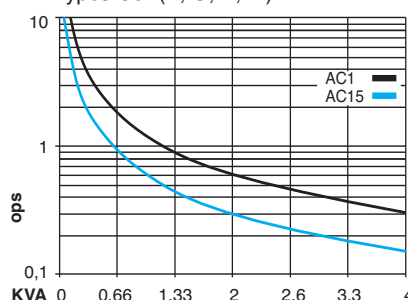
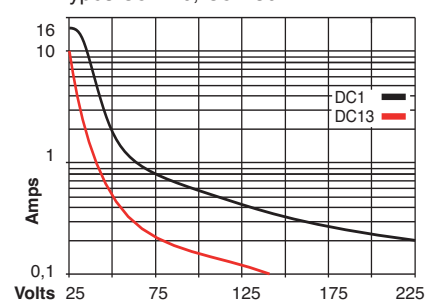
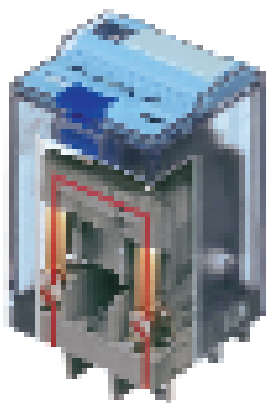

Table 13 Max. DC load
Types C5-A20, C5-A30





C5-X10... Power relay, DC
Single pole, NO, double make

16A / 500V AC1	1,2A @ 220V DC1
7A @ 110V DC1	0,3A @ 220V DC13

C5-M10... Power relay, DC
SP double make. Magnetic blow out

16A / 500V AC1	10A @ 220V DC1
3,6A @ 110V DC13	2A @ 220V DC13

C5-R20... Latching relay
Two change-over contacts, 10 A

10A / 500V AC1	10A @ 30V DC1
6A / 500V AC15	0,5A @ 110V DC1

Contacts

Materials code **0** (standard)
Max. switching current 16 A
Peak inrush current (20 ms) 40 A
Max. switching voltage, (pollution 3) 500 V
Max. AC load (Table 12, pag.12) 4 KVA
Max. DC load See Table 15

Contacts

Materials code **0** (standard)
Max. switching current 16 A
Peak inrush current (20 ms) 40 A
Max. switching voltage, (pollution 3) 500 V
Max. AC load (Table 12, pag. 12) 4 KVA
Electrical life, DC See Tables 6 and 7, pag. 9

Contacts

Materials code **0** (standard)
Max. switching current 10 A
Peak inrush current (20 ms) 30 A
Max. switching voltage, (pollution 3) 500 V
Max. AC load (Table 1, pag. 7) 2,5 KVA
Max. DC load See Table 2, pag. 7

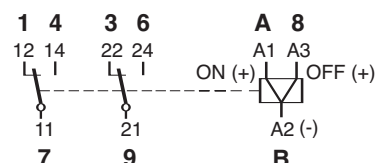
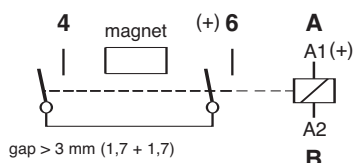
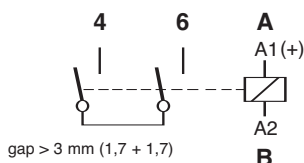

Standard types (50/60 Hz and DC)

AC 24, 48, 115 (110 ... 120), 230, 400
X = LED **C5-X10** X/ ... V
RC suppressor **C5-X10R** / ... V

Standard types (50/60 Hz and DC)

AC 24, 48, 115 (110 ... 120), 230, 400
X = LED **C5-M10** X/ ... V
RC suppressor **C5-M10R** / ... V

Standard types (50/60 Hz and DC)

AC 24, 48, 115 (110 ... 120), 230
C5-R20 / ... V

DC 12, 24, 48, 110, 120/125, 220

X = LED **C5-X10** X/ ... V
Free wheeling diode **C5-X10D** X/ ... V
Free wheeling and polarity **C5-X10F** X/ ... V
AC/DC rectifier (60V max.) **C5-X20B** X/ ... V

DC 12, 24, 48, 110, 120/125, 220

X = LED **C5-M10** X/ ... V
Free wheeling diode **C5-M10D** X/ ... V
Free wheeling and polarity **C5-M10F** X/ ... V
AC/DC rectifier (60V max.) **C5-M20B** X/ ... V

DC 12, 24, 48, 110, 125

(two windings) **C5-R20** / ... V

Note: All AC and DC coils withstand permanent connection.

Specifications

Nominal coil power: 2,4 VA (AC), 1,3 W (DC)
Operate time 20 ms.
Release time 10 ms.
Isolation: EN60947 pollution 3, Gr C 500V
Dielectric strength, contacts / coil 4 KV
Weight avg. 90 grs.

Specifications

Nominal coil power: 2,4 VA (AC), 1,3 W (DC)
Operate time 20 ms.
Release time 10 ms.
Isolation: EN60947 pollution 3, Gr C 500V
Dielectric strength, contacts / coil 4 KV
Weight avg. 90 grs.

Specifications

ON pulse power 1,5 VA/ W
OFF pulse power 0,5 VA/ W
Min. pulse length for ON/OFF control 50 ms.
Isolation: EN60947 pollution 3, Gr C 500V
Dielectric strength, contacts / coil 4 KV
Dielectric strength, pole / pole 4 KV



Table 14 Max. DC load
Type C5-G30

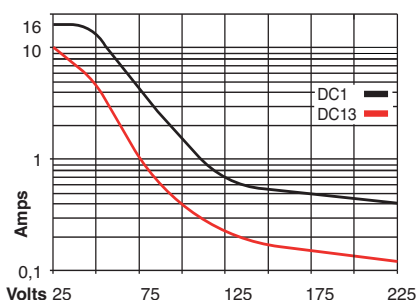

Table 15 Max. DC load
Type C5-X10

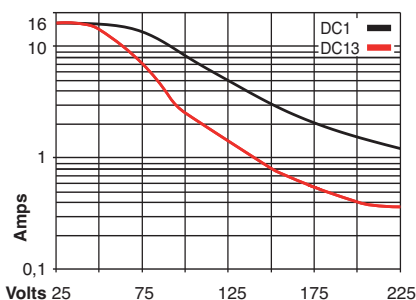
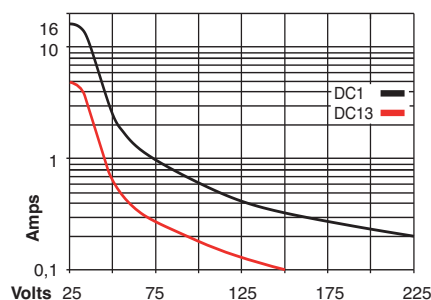
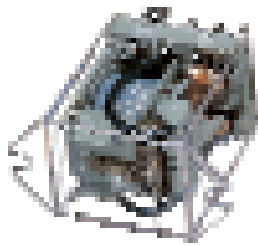
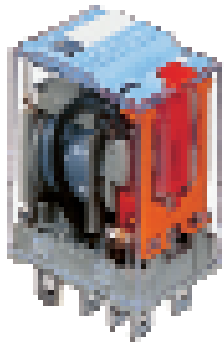

Table 16 Max. DC load
Type C7-A10





C7-A20... General purpose
Two change-over contacts, 10 A

10A / 250V AC1 10A @ 30V DC1
6A / 250V AC15 0,5A @ 110V DC1

Contacts

Materials code **0** (standard); options: 8 - 9
Max. switching current 10 A
Peak inrush current (20 ms) 30 A
Max. switching voltage, (pollution 3) 250 V
Max. switching voltage, (pollution 2) 400 V
Max. AC load (Table 17) 2,5 KVA
Max. DC load See Table 2, pag. 7

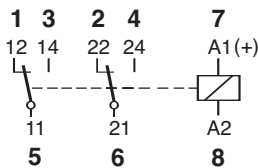

Standard types (50/60 Hz and DC)

AC 24, 48, 115 (110 ... 120), **230**
X = LED **C7-A20** X/ ... V

DC 12, 24, 48, 110, 120/125, 220
X = LED **C7-A20** X/ ... V
Free wheeling diode **C7-A20D** X/ ... V
Free wheeling and polarity **C7-A20F** X/ ... V
AC/DC rectifier (60V max.) **C7-A20B** X/ ... V

Specifications

Nominal coil power: 1,2 VA (AC), 1 W (DC)
Operate time 16 ms.
Release time 8 ms.
Isolation: EN60947 pollution 3, Gr C 250V
Dielectric strength, contacts / coil 2,5 KV
Dielectric strength, pole / pole 2,5 KV
Weight avg. 43 grs.

C7-T21... Low level
Two change-over, bifurcated contacts

6A / 250V AC1 6A @ 30V DC1
Min. 1mA @ DC 5V

Contacts

Materials code **1** (standard); option: 2
Switching current: min. 1 mA; max. 6 A
Peak inrush current (5 ms) 15 A
Max. switching voltage, (pollution 3) 250 V
Max. switching voltage, (pollution 2) 400 V
Max. AC load (Table 3, pag. 8) 1,2 KVA
Max. DC load See Table 18

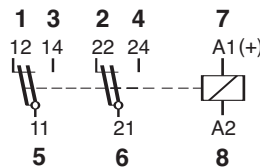

Standard types (50/60 Hz and DC)

AC 24, 48, 115 (110 ... 120), **230**
X = LED **C7-T21** X/ ... V

DC 12, 24, 48, 110, 120/125, 220
X = LED **C7-T21** X/ ... V
Free wheeling diode **C7-T21D** X/ ... V
Free wheeling and polarity **C7-T21F** X/ ... V
AC/DC rectifier (60V max.) **C7-T21B** X/ ... V

Specifications

Nominal coil power: 1,2 VA (AC), 1 W (DC)
Operate time 16 ms.
Release time 8 ms.
Isolation: EN60947 pollution 3, Gr C 250V
Dielectric strength, contacts / coil 2,5 KV
Dielectric strength, pole / pole 2,5 KV
Weight avg. 43 grs.

C7-A10...* General purpose
One change-over contact, 16 A

16A / 250V AC1 16A @ 30V DC1
8A / 250V AC15 0,5A @ 110V DC1

Contacts

Materials code **0** (standard)
Max. switching current 16 A
Peak inrush current (20 ms) 40 A
Max. switching voltage, (pollution 3) 250 V
Max. switching voltage, (pollution 2) 400 V
Max. AC load 4 KVA
Max. DC load See Table 16, pag.13

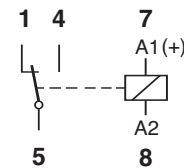

Standard types (50/60 Hz and DC)

AC 24, 48, 115 (110 ... 120), **230**
X = LED **C7-A10** X/ ... V

DC 12, 24, 48, 110, 120/125
X = LED **C7-A10** X/ ... V
Free wheeling diode **C7-A10D** X/ ... V
Free wheeling and polarity **C7-A10F** X/ ... V
AC/DC rectifier (60V max.) **C7-A10B** X/ ... V

Specifications

Nominal coil power: 1,2 VA (AC), 1,3 W (DC)
Operate time 16 ms.
Release time 8 ms.
Isolation: EN60947 pollution 3, Gr C 250V
Dielectric strength, contacts / coil 2,5 KV
Weight avg. 43 grs.
* Plug only in S7-16 socket



Dimensions (mm)

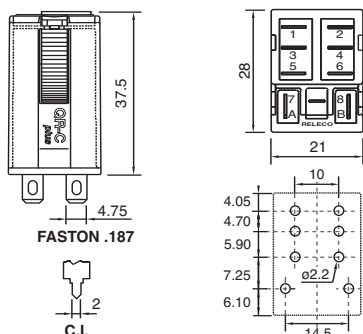

Table 17 Electrical life (ops x 10⁶)
Types C7-A20, C7-G20, C7-X, C7-W

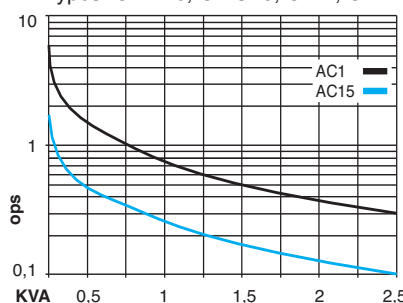
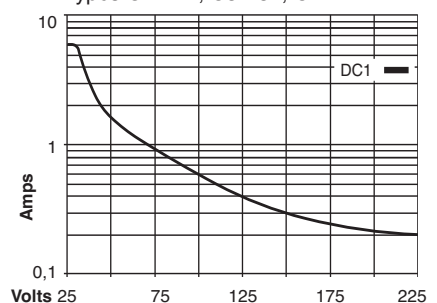

Table 18 Max. DC load
Types C2-T21, C3-T31, C7-T21





C7-G20... Power relay, DC Two open contacts, gap 1,5 mm

10A / 250V AC1 0,8A @ 110V DC1
0,4A @ 220V DC1 0,3A @ 110V DC13

Contacts

Materials code **0** (standard)
Max. switching current 10 A
Peak inrush current (20 ms) 30 A
Max. switching voltage, (pollution 3) 250 V
Max. switching voltage, (pollution 2) 400 V
Max. AC load (Table 17, pag.14) 2,5 KVA
Max. DC load See Table 19

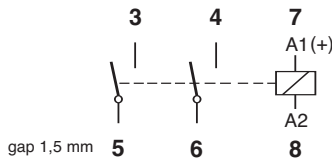

Standard types (50/60 Hz and DC)

AC 24, 48, 115 (110 ... 120), **230**
X = LED **C7-G20** X/ ... V

DC 12, 24, 48, 110, 120/125
X = LED **C7-G20** X/ ... V
Free wheeling diode **C7-G20D** X/ ... V
Free wheeling and polarity **C7-G20F** X/ ... V
AC/DC rectifier (60V max.) **C7-G20B** X/ ... V

Specifications

Nominal coil power: 1,8 VA (AC), 1,5 W (DC)
Operate time 20 ms.
Release time 10 ms.
Isolation: EN60947 pollution 3, Gr C 250V
Dielectric strength, contacts / coil 2,5 KV
Dielectric strength, pole / pole 2,5 KV
Weight avg. 43 grs.

C7-X10... Power relay, DC Single pole, NO, double make

10A / 250V AC1 1A @ 220V DC1
6A @ 110V DC1 0,3A @ 220V DC13

Contacts

Materials code **0** (standard)
Max. switching current 10 A
Peak inrush current (20 ms) 30 A
Max. switching voltage, (pollution 3) 250 V
Max. switching voltage, (pollution 2) 400 V
Max. AC load (Table 17, pag. 14) 2,5 KVA
Max. DC load See Table 20

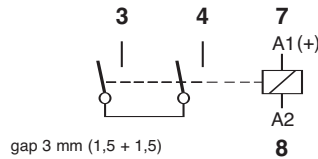

Standard types (50/60 Hz and DC)

AC 24, 48, 115 (110 ... 120), **230**
X = LED **C7-X10** X/ ... V

DC 12, 24, 48, 110, 120/125
X = LED **C7-X10** X/ ... V
Free wheeling diode **C7-X10D** X/ ... V
Free wheeling and polarity **C7-X10F** X/ ... V
AC/DC rectifier (60V max.) **C7-X10B** X/ ... V

Specifications

Nominal coil power: 1,8 VA (AC), 1,3 W (DC)
Operate time 20 ms.
Release time 10 ms.
Isolation: EN60947 pollution 3, Gr C 250V
Dielectric strength, contacts / coil 2,5 KV
Weight avg. 43 grs.

C7-W10... High inrush current Single pole, two contacts in parallel wolfram and silver

10A / 250V AC15 6A @ 250V AC5a/b

Contacts

Materials code **0** (standard)
Max. switching current 10 A
Peak inrush current (2,5 ms) 500 A
Max. switching voltage, (pollution 3) 250 V
Max. switching voltage, (pollution 2) 400 V
Max. AC load (Table 17, pag. 14) 2,5 KVA
Electrical life, AC5 a/b (lamps) See Table 21

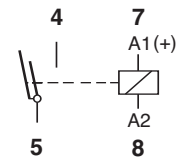

Standard types (50/60 Hz and DC)

AC 24, 48, 115 (110 ... 120), **230**
X = LED **C7-W10** X/ ... V

DC 12, 24, 48, 110, 120/125
X = LED **C7-W10** X/ ... V
Free wheeling diode **C7-W10D** X/ ... V
Free wheeling and polarity **C7-W10F** X/ ... V
AC/DC rectifier (60V max.) **C7-W10B** X/ ... V

Specifications

Nominal coil power: 1,5 VA (AC), 1,5 W (DC)
Operate time 20 ms.
Release time 10 ms.
Isolation: EN60947 pollution 3, Gr C 250V
Dielectric strength, contacts / coil 2,5 KV
Weight avg. 43 grs.

Table 19 Max. DC load
Type C7-G20

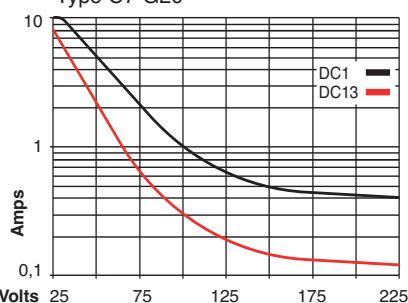

Table 20 Max. DC load
Type C7-X10

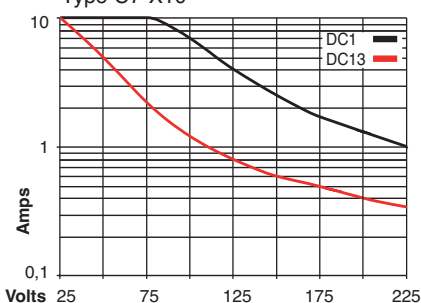
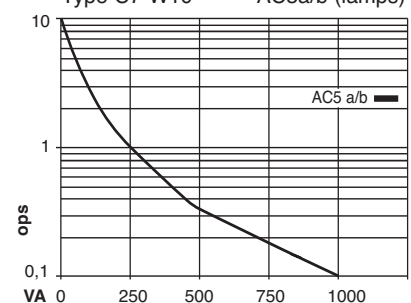
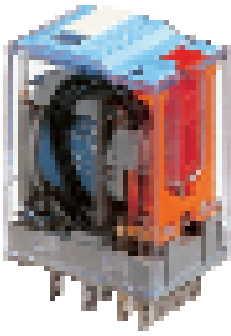

Table 21 Electrical life (ops x 10⁶)
Type C7-W10 AC5a/b (lamps)





C9-A41... General purpose
Four change-over contacts, 5 A

5A / 250V AC1 5A @ 30V DC1
1A / 250V AC15 0,2A @ 110V DC1

Contacts

Materials code 1 (standard); option: 2
Max. switching current 5 A
Peak inrush current (10 ms) 15 A
Max. switching voltage, (pollution 2) 150 V
Max. AC resistive load (Table 22) 0,7 KVA
Max. DC load See Table 23

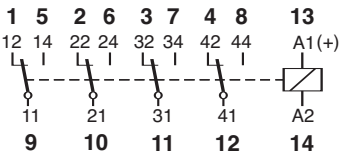

Standard types (50/60 Hz and DC)

AC 24, 48, 115 (110 ... 120), **230**
X = LED **C9-A41** X/ ... V

DC 12, 24, 48, 110, 120/125, 220
X = LED **C9-A41** X/ ... V
Free wheeling diode **C9-A41D** X/ ... V
Free wheeling and polarity **C9-A41F** X/ ... V
AC/DC rectifier (60V max.) **C9-A41B** X/ ... V

Specifications

Nominal coil power: 1,2 VA (AC), 1 W (DC)
Operate time 10 ms.
Release time 6 ms.
Isolation: EN60947 pollution 2 150V
Dielectric strength, contacts / coil 2,5 KV
Dielectric strength, pole / pole 2 KV
Weight avg. 43 grs.

C9-E21... Sensitive, 500 mW
Two change-over contacts, 5 A

Operating range: 0,8 ... 1,7 x U_N
5A / 250V AC1 5A @ 30V DC1

Contacts

Materials code 1 (standard); option: 2
Max. switching current 5 A
Peak inrush current (10 ms) 15 A
Max. switching voltage, (pollution 3) 250 V
Max. AC resistive load (Table 22) 0,7 KVA
Max. DC load See Table 23

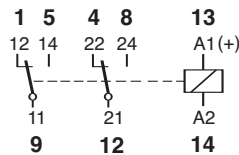

Standard types (50/60 Hz and DC)

AC 24, 48, 115 (110 ... 120), **230**
X = LED (see pag. 6) **C9-E21** X/ ... V

DC 12, 24, 48, 110
X = LED (see pag. 6) **C9-E21** X/ ... V
Free wheeling diode **C9-E21D** X/ ... V
Free wheeling and polarity **C9-E21F** X/ ... V
AC/DC rectifier (60V max.) **C9-E21B** X/ ... V

Specifications

Nominal coil power: 1 VA (AC), 500 mW (DC)
Operate time 10 ms.
Release time 6 ms.
Isolation: EN60947 pollution 3, Gr C 250V
Dielectric strength, contacts / coil 2,5 KV
Dielectric strength, pole / pole 2,5 KV
Note: Specifications valid without LED or diodes

C9-R21... Latching
Two change-over contacts, 5 A

5A / 250V AC1 5A @ 30V DC1
1A / 250V AC15 0,2A @ 110V DC1

Contacts

Materials code 1 (standard)
Max. switching current 5 A
Peak inrush current (10 ms) 15 A
Max. switching voltage, (pollution 3) 250 V
Max. AC resistive load (Table 22) 0,7 KVA
Max. DC load See Table 23

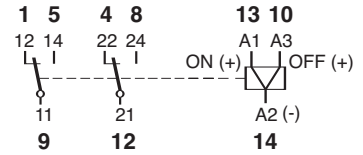

Standard types (50/60 Hz and DC)

AC 24, 48, 115 (110 ... 120), **230**
C9-R21 / ... V

DC 12, 24, 48, 60
(two windings) **C9-R21** / ... V

Note: All AC and DC coils withstand permanent connection

Specifications

ON pulse power 1,2 VA/ W
OFF pulse power 0,6 VA/ W
Min. pulse length for ON/OFF control 50 ms.
Isolation: EN60947 pollution 3, Gr C 250V
Dielectric strength, contacts / coil 2,5 KV
Dielectric strength, pole / pole 2,5 KV
Weight avg. 43 grs.

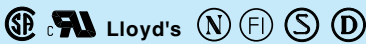

Lloyd's

Dimensions (mm)

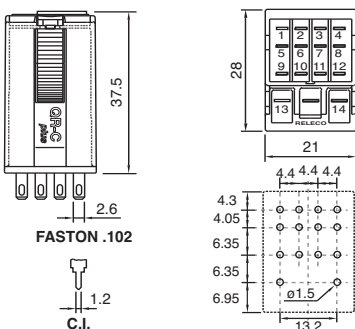

Table 22 Electrical life (ops x 10⁶)
Types C9-A41, C9-E21, C9-R21

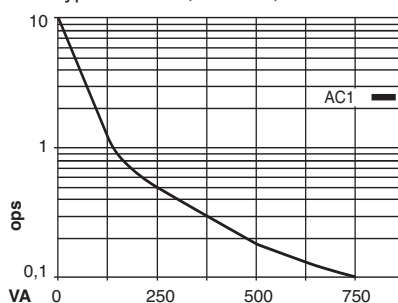
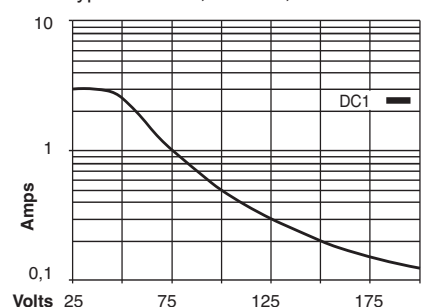

Table 23 Max. DC load
Types C9-A41, C9-E21, C9-R21





The modules **CT2** and **CT3** are electronic timers which are designed to be inserted between a standard plug-in relay and its socket, enabling the relay to be operated as a timer relay.

The **CT** modules are able to accept any standard 8 or 11 pin RELECO series C2 or C3 as well as those from any other supplier.

The relay coil voltage must be in the range shown for each model.

CT2A CT3A Off delay

The timing starts when **S** is switched off. The relay drops out at time (**t**)

CT2B CT3B Blinker

The relay blinks ON/OFF at time (**t**) when switch **S** is closed. First pulse, ON

CT2E CT3E On delay

The timing starts when the switch **S** is closed. The relay pulls in at the time (**t**)

CT2K CT3K One shot, aux. pulse

The relay turns ON with a pulse on the switch **S** and turns OFF at the time (**t**)

CT2W CT3W One shot

The relay turns ON as switch **S** is closed and turns OFF at the time (**t**)

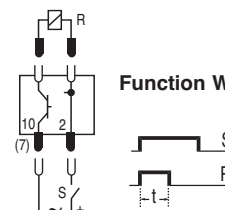
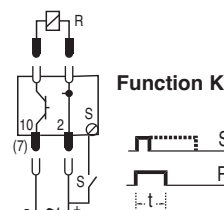
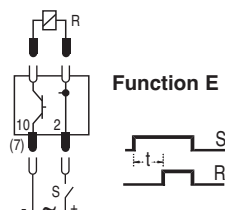
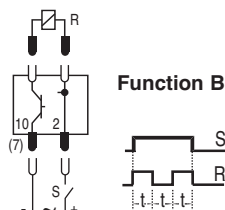
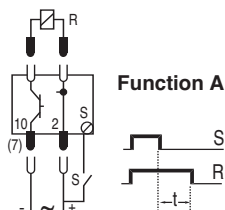

CT2... (8 pin) and CT3... (11 pin) types with time range from 0,2 seconds to 30 minutes (range 30)

CT2-A30/S* 9,5 ... 18 V
CT2-A30/L 20 ... 65 V
CT2-A30/M 90 ... 150 V
CT2-A30/U 180 ... 265 V

CT2-B30/S* 9,5 ... 18 V
CT2-B30/L 20 ... 65 V
CT2-B30/H 90 ... 265 V

CT2-E30/S* 9,5 ... 18 V
CT2-E30/L 20 ... 65 V
CT2-E30/H 90 ... 265 V

CT2-K30/S* 9,5 ... 18 V
CT2-K30/L 20 ... 65 V
CT2-K30/M 90 ... 150 V
CT2-K30/U 180 ... 265 V

CT2-W30/S* 9,5 ... 18 V
CT2-W30/L 20 ... 65 V
CT2-W30/H 90 ... 265 V

CT3-A30/S* 9,5 ... 18 V
CT3-A30/L 20 ... 65 V
CT3-A30/M 90 ... 150 V
CT3-A30/U 180 ... 265 V

CT3-B30/S* 9,5 ... 18 V
CT3-B30/L 20 ... 65 V
CT3-B30/H 90 ... 265 V

CT3-E30/S* 9,5 ... 18 V
CT3-E30/L 20 ... 65 V
CT3-E30/H 90 ... 265 V

CT3-K30/S* 9,5 ... 18 V
CT3-K30/L 20 ... 65 V
CT3-K30/M 90 ... 150 V
CT3-K30/U 180 ... 265 V

CT3-W30/S* 9,5 ... 18 V
CT3-W30/L 20 ... 65 V
CT3-W30/H 90 ... 265 V

*All types are for AC/DC except "S" voltage range (only DC)

Specifications

Time accuracy:

Repetition	+ 0,5% / 20 ms.
Supply voltage	1 ms / volt.
Ambient temperature	-0,25% / K
Reset time (types E, W, B)	< 150 ms.
Reset time (types A, K)	< 200 ms.
Triggering time: AC	80 ms ; DC, 50 ms.
Ambient temperature	-10°C ... +60°C
Transient protection	IEC 255.4
Housing material:	Noryl SE1 (UL94V-1)
Protection class (DIN 40050)	IP40
Weight avg.	35 grs.

Time range setting

Range 30

0,2 - 3 s	
2 - 30 s	
0,2 - 3 min	
2 - 30 min	

Dip - Sw



Dimensions

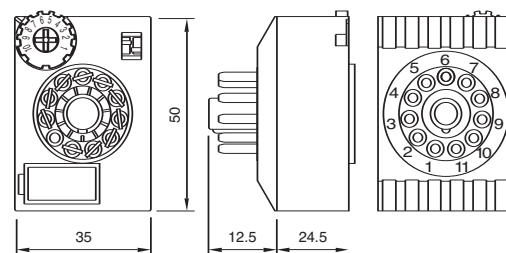

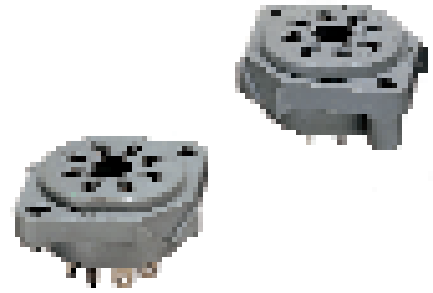

S2-B One level. Coding ring Integrated clip and marking label

Accepts the exclusive Releco coding ring for coding both the relay and base. DIN rail or panel mountable. Removable label. EN/DIN and sequential numbering. According to EN60947

Wiring diagram

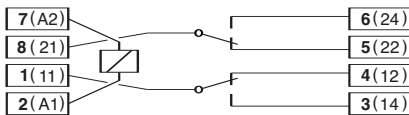

Specifications

Nominal load 10A / 300V
Dielectric strength (adjacent screws) 2,5 KV
Dielectric strength (screws / rail) 2,5 KV
Max. screw torque 1,2 Nm
Screw dimensions M3, Pozi
Wire in-lets capacity:
Solid wire 4 mm² or 2 x 2,25 mm²
Multi-core 22 - 14 AWG



S2-S Two level. Coding ring Integrated clip and marking label

Accepts the exclusive Releco coding ring for coding both the relay and base. DIN rail or panel mountable. Removable label. EN/DIN and sequential numbering. According to EN60947

Wiring diagram

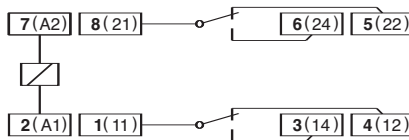

Specifications

Nominal load 10A / 300V
Dielectric strength (adjacent screws) 2,5 KV
Dielectric strength (screws / rail) 2,5 KV
Max. screw torque 1,2 Nm
Screw dimensions M3, Pozi
Wire in-lets capacity:
Solid wire 4 mm² or 2 x 2,25 mm²
Multi-core 22 - 14 AWG



S2-L S2-PO 8 pin, solder and printed circuit tags

S2-L Flange panel mountable.

S2-PO Printed circuit tags with flange.

Printed circuit lay-out

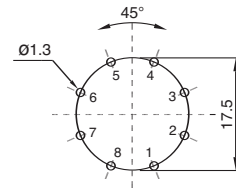

Specifications

Nominal load 10 A / 300 V
Dielectric strength (adjacent pin) 2,5 KV
Hard brass, tin-plated terminals

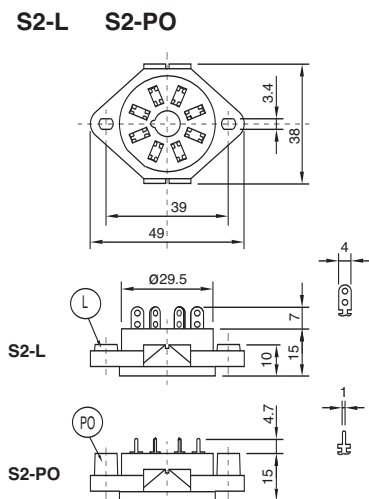
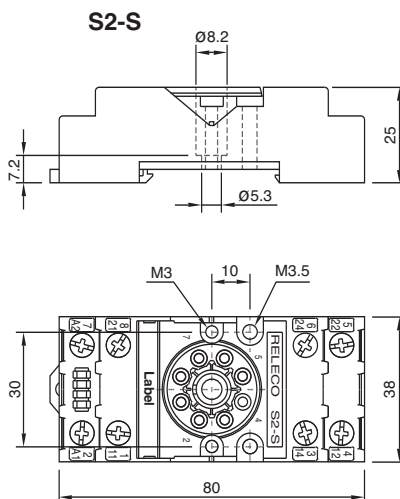
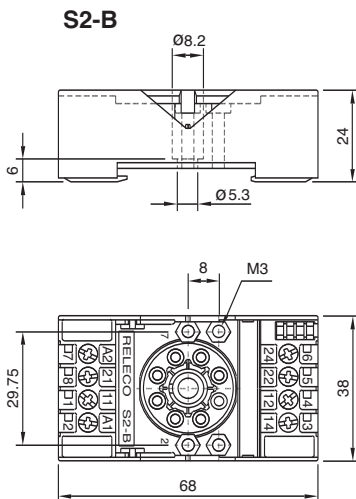



S3-B One level. Coding ring Integrated clip and marking label

Accepts the exclusive Releco coding ring for coding both the relay and base. DIN rail or panel mountable. Removable label. EN/DIN and sequential numbering. According to EN60947

Wiring diagram

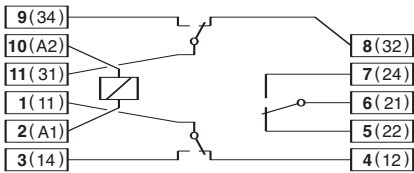

Specifications

Nominal load	10A / 250V
Dielectric strength (adjacent screws)	2,5 KV
Dielectric strength (screws / rail)	2,5 KV
Max. screw torque	1,2 Nm
Screw dimensions	M3, Pozi
Wire in-lets capacity:	
Solid wire	4 mm ² or 2 x 2,25 mm ²
Multi-core	22 - 14 AWG



S3-B

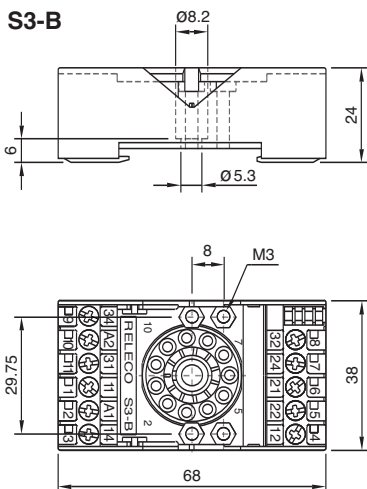

S3-S Two level. Coding ring Integrated clip and marking label

Accepts the exclusive Releco coding ring for coding both the relay and base. DIN rail or panel mountable. Removable label. EN/DIN and sequential numbering. According to EN60947

Wiring diagram

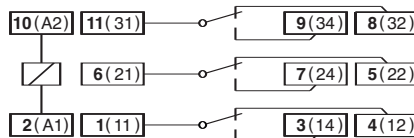

Specifications

Nominal load	10A / 250V
Dielectric strength (adjacent screws)	2,5 KV
Dielectric strength (screws / rail)	2,5 KV
Max. screw torque	1,2 Nm
Screw dimensions	M3, Pozi
Wire in-lets capacity:	
Solid wire	4 mm ² or 2 x 2,25 mm ²
Multi-core	22 - 14 AWG

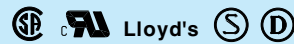

S3-S

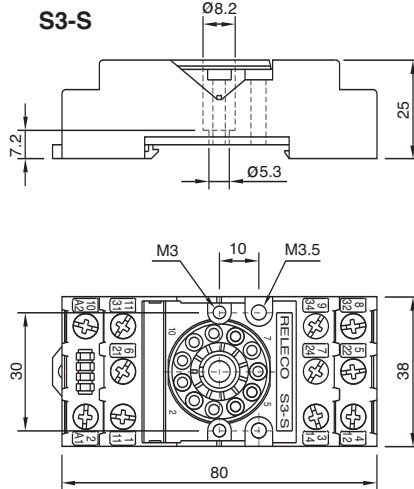

S3-L S3-PO 11 pin, solder and printed circuit tags

S3-L Flange panel mountable.

S3-PO Printed circuit tags with flange.

Printed circuit lay-out

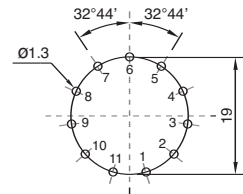

Specifications

Nominal load	10 A / 250 V
Dielectric strength (adjacent pin)	2,5 KV
Hard brass, tin-plated terminals	

S3-L S3-PO

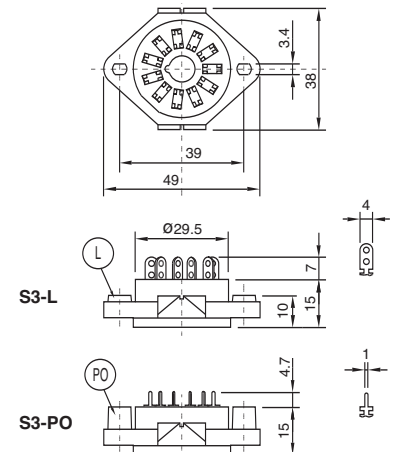

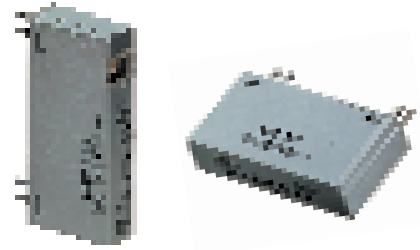

S3-MP One level, screws in line Logic wiring and Modules

Accepts the plug-in modules **M3P** in parallel with the relay coil.
Integrated hold-down clip and removable marking label. DIN rail or panel mountable. EN/DIN and sequential numbering.

Wiring diagram

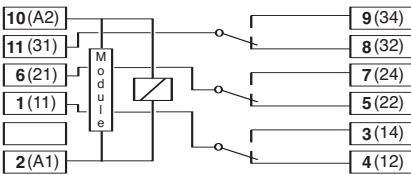

Specifications

Nominal load	10 A / 250 V
Dielectric strength (adjacent screws)	2,5 KV
Dielectric strength (screws / rail)	2,5 KV
Max. screw torque	1,2 Nm
Screw dimensions	M3, Pozi
Wire in-lets capacity:	
Solid wire	4 mm ² or 2 x 2,25 mm ²
Multi-core	22 - 14 AWG

S3-MS One level, screws in line Logic wiring and Modules

Accepts the plug-in modules **M3S** in series with the coil and **M3P** in parallel.
Integrated hold-down clip and removable marking label. DIN rail or panel mountable. EN/DIN and sequential numbering.

Wiring diagram

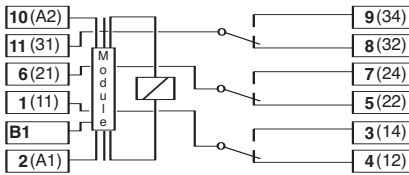

Specifications

Nominal load	10 A / 250 V
Dielectric strength (adjacent screws)	2,5 KV
Dielectric strength (screws / rail)	2,5 KV
Max. screw torque	1,2 Nm
Screw dimensions	M3, Pozi
Wire in-lets capacity:	
Solid wire	4 mm ² or 2 x 2,25 mm ²
Multi-core	22 - 14 AWG

M3P Plug in modules for S3-MP

In parallel with the coil

Signaling LED

M3P-X / 24 Vac/dc
M3P-X / 48 Vac/dc
M3P-X / 110 ... 125 Vac/dc
M3P-X / 200 ... 230 Vac/dc

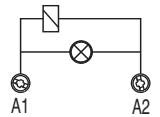

Free wheeling diode

M3P-DL / 12 ... 60 Vdc
M3P-DH / 12 ... 250 Vdc

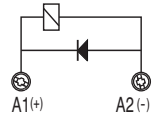

Free wheeling diode and LED

M3P-DX / 24 Vdc
M3P-DX / 48 Vdc
M3P-DX / 110 ... 125 Vdc
M3P-DX / 200 ... 230 Vdc

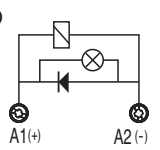

RC suppressor
(LED not available)

M3P-RC / 20 ... 50 Vac
M3P-RC / 110 ... 120 Vac
M3P-RC / 220 ... 240 Vac

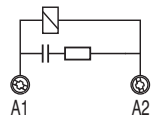

M3S Plug in modules for S3-MS

In series with the coil

Free wheeling and polarity

M3S-FL / 12 ... 60 Vdc
M3S-FH / 12 ... 250 Vdc

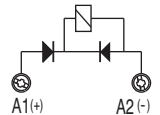

Free wheeling, polarity and LED

M3S-FX / 24 Vdc
M3S-FX / 48 Vdc
M3S-FX / 110 ... 125 Vdc
M3S-FX / 200 ... 230 Vdc

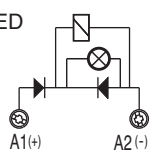

Rectifier bridge and LED

M3S-B / 12 ... 48 Vac/dc
M3S-BX / 12 Vac/dc
M3S-BX / 24 Vac/dc
M3S-BX / 48 Vac/dc

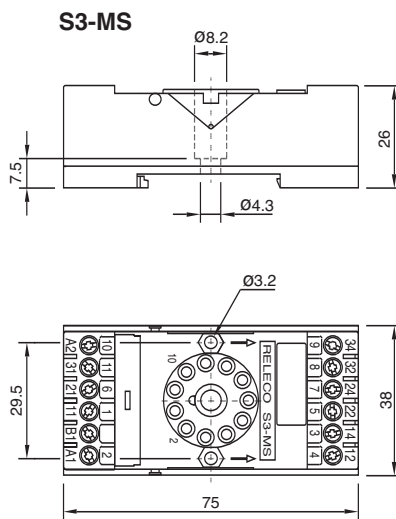
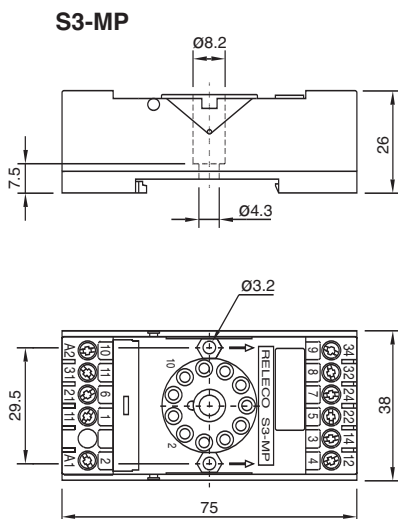
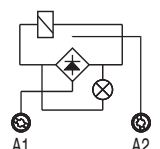

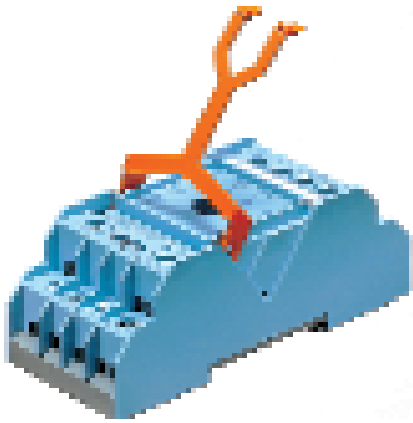

S4-B

Two level screws
Logic wiring

Integrated hold-down clip and removable marking label. DIN rail or panel mountable. EN/DIN and sequential numbering. According to EN60947

Wiring diagram

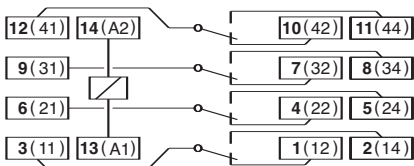

Specifications

Nominal load 10 A / 250 V
Dielectric strength (adjacent screws) 2,5 KV
Dielectric strength (screws / rail) 2,5 KV
Max. screw torque 1,2 Nm
Screw dimensions M3, Pozi
Wire in-lets capacity:
Solid wire 4 mm² or 2 x 2,25 mm²
Multi-core 22 - 14 AWG

Lloyd's

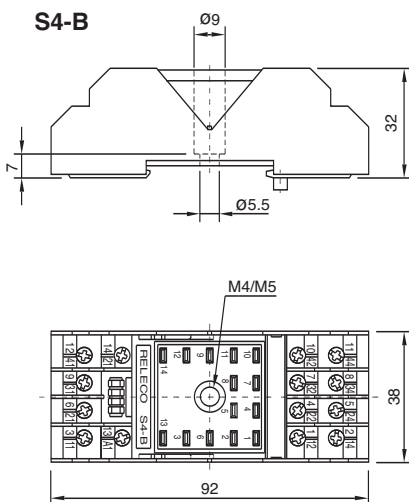

S4-L

S4-P

S4-PO

14 pin, solder and printed circuit tags

S4-L Flange panel mountable.

S4-P Printed circuit tags.

S4-PO Printed circuit tags with flange.

Printed circuit lay-out

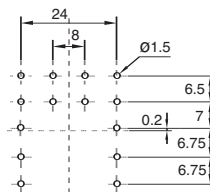

Specifications

Nominal load 10 A / 250 V
Dielectric strength (adjacent pins) 2,5 KV
Hard brass tin-plated terminals

S4-R

S5-R

S4-4

Mounting accessories

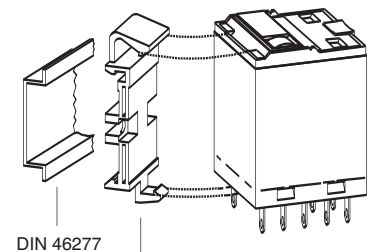

S4-R

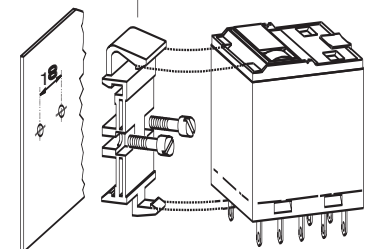

S5-R

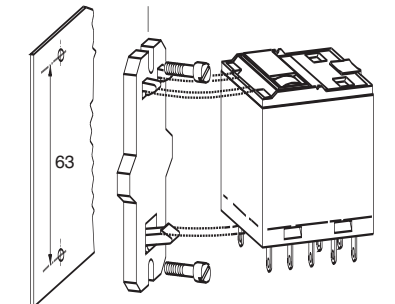

S4-4

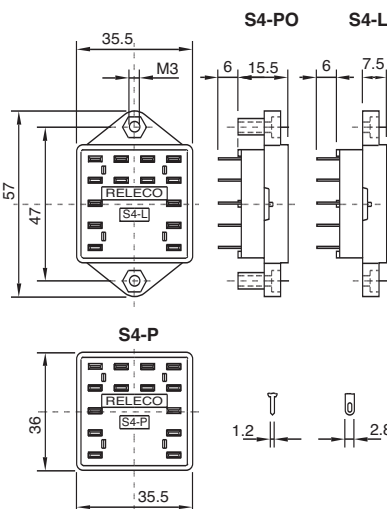

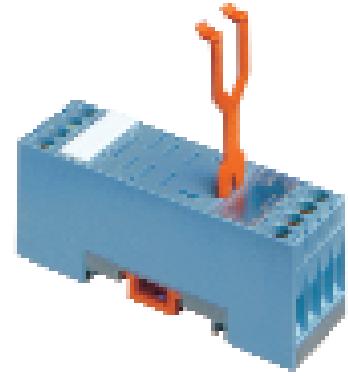

S5-S

Two level screws
Logic wiring

Integrated hold-down clip and removable marking label. DIN rail or panel mountable. EN/DIN and sequential numbering. According to EN60947

Wiring diagram

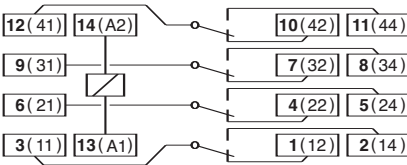

Specifications

Nominal load 16 A / 400 V
Dielectric strength (adjacent screws) 2,5 KV
Dielectric strength (screws / rail) 2,5 KV
Max. screw torque 1,2 Nm
Screw dimensions M3, Pozi
Wire in-lets capacity:
Solid wire 4 mm² or 2 x 2,25 mm²
Multi-core 22 - 14 AWG



S5-L

S5-P

S5-PO

Solder and printed circuit tags

S5-L Flange panel mountable.

S5-P Printed circuit tags.

S5-PO Printed circuit tags with flange.

Printed circuit lay-out

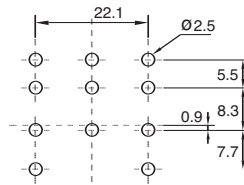

Specifications

Nominal load 16 A / 400 V
Dielectric strength (adjacent screws) 2,5 KV
Hard brass tin-plated terminals

S7-M

One level, screws on line

S7-16

22,5 mm wide

Socket offers an optimum packing density and is provided with sturdy screws terminals. DIN rail or panel mountable. Integrated clip. Removable marking label EN/DIN and sequential numbering.

Wiring diagram

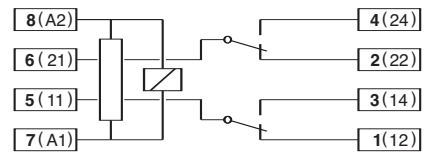

Specifications

Nominal load S7-M 10 A / 250 V
Nominal load S7-16 16 A / 250 V
Dielectric strength (adjacent screws) 2,5 KV
Dielectric strength (screws / rail) 2,5 KV
Max. screw torque 1,2 Nm
Screw dimensions M3, Pozi
Wire in-lets capacity:
Solid wire 4 mm² or 2 x 2,25 mm²
Multi-core 22 - 14 AWG

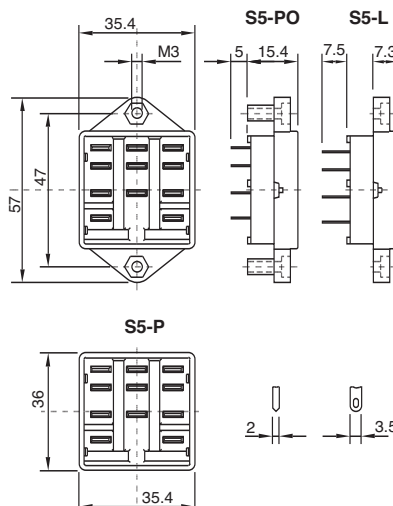
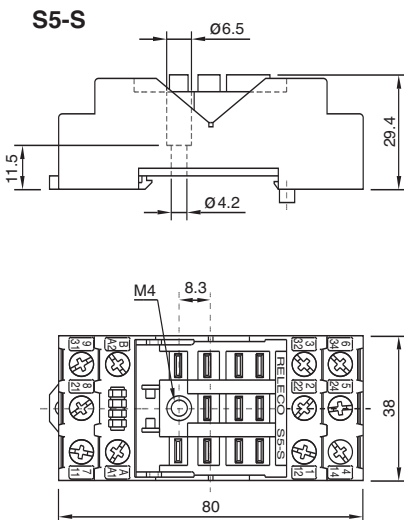

S7-M

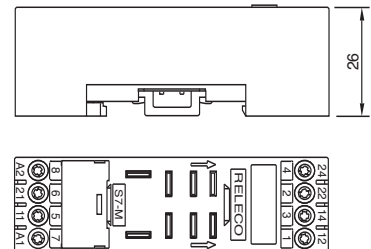

S7-16 for C7-A10 relay (16A)

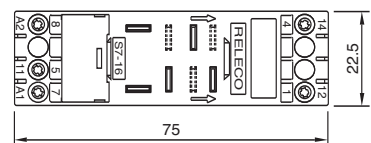

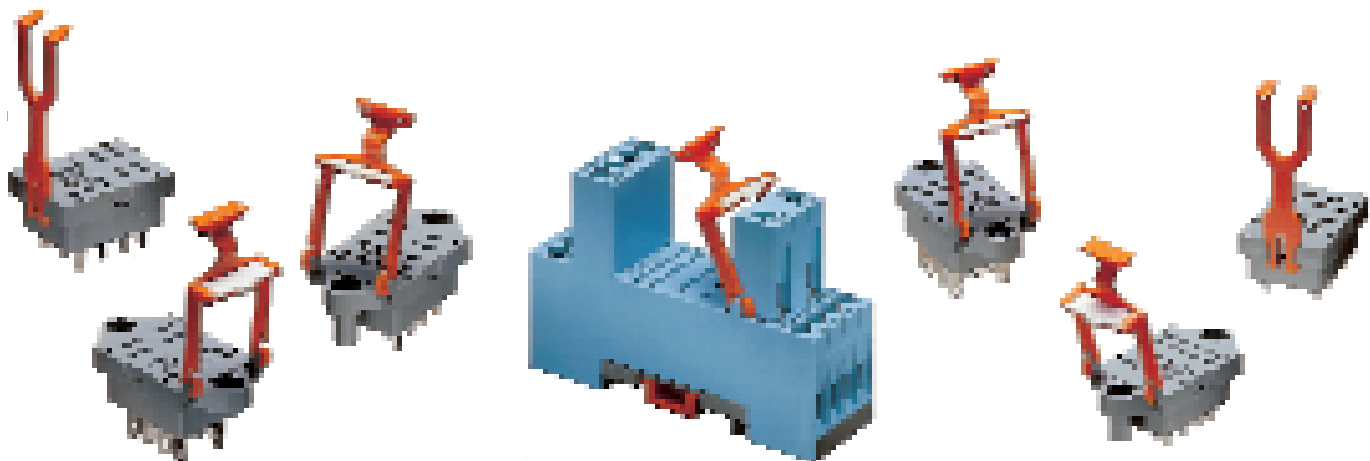

S7-L S7-P S7-PO

Solder and printed circuit tags

- S7-L** Flange panel mountable.
- S7-P** Printed circuit tags.
- S7-PO** Printed circuit tags with flange.

Printed circuit lay-out

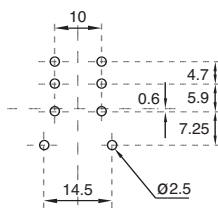

Specifications

Nominal load 10 A / 250 V
 Dielectric strength (adjacent screws) 2,5 KV
 Hard brass tin-plated terminals

S9-M Two level, screws in line

22,5 mm wide

Socket offers an optimum packing density and is provided with sturdy screws terminals. DIN rail or panel mountable. Integrated clip. Removable marking label. EN/DIN and sequential numbering.

Wiring diagram

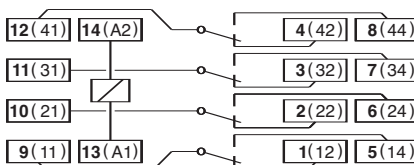

Specifications

Nominal load 6 A / 250 V
 Dielectric strength (adjacent screws) 2,5 KV
 Dielectric strength (screws / rail) 2,5 KV
 Max. screw torque 1,2 Nm
 Screw dimensions M3, Pozi
 Wire in-lets capacity:
 Solid wire 4 mm² or 2 x 2,25 mm²
 Multi-core 22 - 14 AWG

S9-L S9-P S9-PO

Solder and printed circuit tags

- S9-L** Flange panel mountable.
- S9-P** Printed circuit tags.
- S9-PO** Printed circuit tags with flange.

Printed circuit lay-out

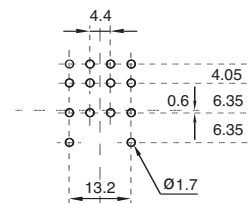

Specifications

Nominal load 6 A / 250 V
 Dielectric strength (adjacent screws) 2,5 KV
 Hard brass tin-plated terminals

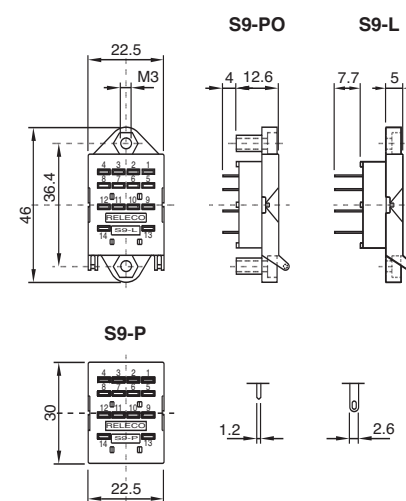
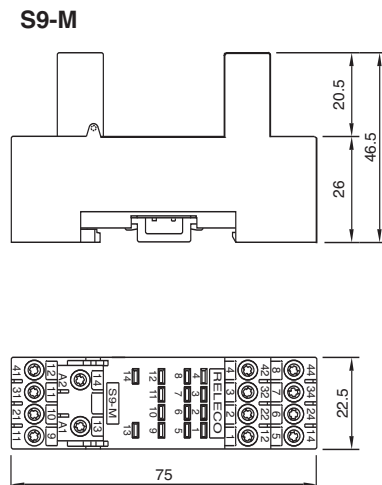
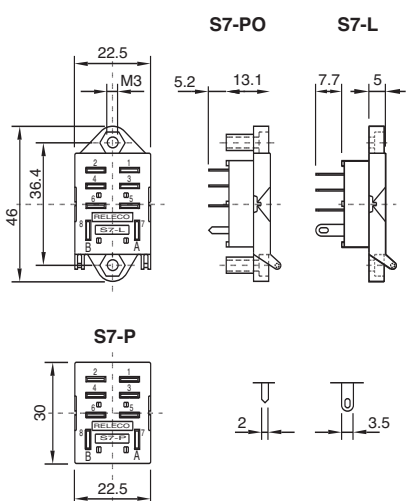
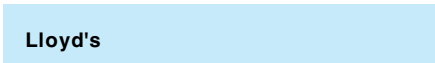
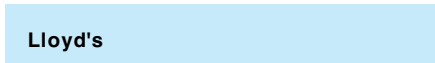

X-ON Electronics

Largest Supplier of Electrical and Electronic Components

Click to view similar products for [General Purpose Relays](#) category:

Click to view products by [Releco](#) manufacturer:

Other Similar products are found below :

[APF30318](#) [JVN1AF-4.5V-F](#) [PCN-105D3MHZ](#) [5JO-10000S-SIL](#) [5JO-1000CD-SIL](#) [5JO-400CD-SIL](#) [LY2S-AC220/240](#) [LYQ20DC12](#)
[6031007G](#) [6131406HQ](#) [6-1393099-3](#) [6-1393099-8](#) [6-1393122-4](#) [6-1393123-2](#) [6-1393767-1](#) [6-1393843-7](#) [6-1415012-1](#) [6-1419102-2](#) [6-](#)
[1423698-4](#) [6-1608051-6](#) [6-1608067-0](#) [6-1616170-6](#) [6-1616248-2](#) [6-1616282-3](#) [6-1616348-2](#) [6-1616350-1](#) [6-1616350-8](#) [6-1616358-7](#) [6-](#)
[1616359-9](#) [6-1616360-9](#) [6-1616931-6](#) [6-1617039-1](#) [6-1617052-1](#) [6-1617090-2](#) [6-1617090-5](#) [6-1617347-5](#) [6-1617353-3](#) [6-1617801-8](#) [6-](#)
[1617802-2](#) [6-1618107-9](#) [6-1618248-4](#) [M83536/1-027M](#) [CX-4014](#) [MAHC-5494](#) [MAVCD-5419-6](#) [703XCX-120A](#) [7-1393100-5](#) [7-1393111-7](#)
[7-1393144-5](#) [7-1393767-8](#)