

# RM83

## miniature relays

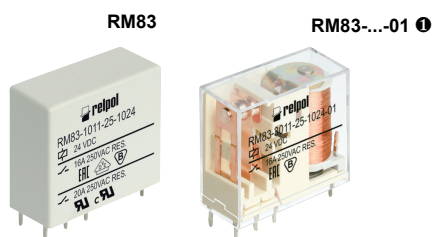

- Miniature dimensions • General purpose relays
- **Version 1 NO AgSnO<sub>2</sub> - for special loads: resistance to inrush current 120 A (20 ms)**
- Protection category IP 40 or IP 67
- For PCB and plug-in sockets
- DC coils - standard and sensitive
- Recognitions, certifications, directives: RoHS,

### Contact data

Number and type of contacts	1 CO, 1 NO, 1 NC	
Contact material	<b>AgSnO<sub>2</sub></b> , AgCdO, AgCdO/Au 0,2 μm	
Rated / max. switching voltage	AC	250 V / 440 V
Min. switching voltage	10 V AgSnO <sub>2</sub> , 10 V AgCdO, 10 V AgCdO/Au 0,2 μm	
Rated load (capacity)	AC1	16 A / 250 V AC
	AC15	6 A / 120 V    3 A / 240 V (A300)
	AC3	550 W (single-phase motor)
	DC1	16 A / 24 V DC (see Fig. 3)
	DC13	0,22 A / 120 V    0,1 A / 250 V (R300)
Min. switching current	10 mA AgSnO <sub>2</sub> , 5 mA AgCdO, 5 mA AgCdO/Au 0,2 μm	
Max. inrush current	30 A 1 NO, AgSnO <sub>2</sub>	
Rated current	16 A	
Max. breaking capacity	AC1	4 000 VA
Min. breaking capacity	1 W AgSnO <sub>2</sub> , 0,5 W AgCdO, 0,5 W AgCdO/Au 0,2 μm	
Contact resistance	≤ 100 mΩ	
Max. operating frequency	AC1	600 cycles/hour
• at rated load • no load		72 000 cycles/hour

### Coil data

Rated voltage	DC	5 ... 110 V standard version    110 V sensitive version
Must release voltage	DC: ≥ 0,1 U <sub>n</sub>	
Operating range of supply voltage	see Table 1	
Rated power consumption	DC	0,6 W    5 ... 60 V standard version 0,6 W    110 V sensitive version 0,9 W    110 V standard version

### Insulation according to PN-EN 60664-1

Insulation rated voltage	400 V AC	
Dielectric strength		
• between coil and contacts	4 000 V AC	type of insulation: reinforced
• contact clearance	1 000 V AC	type of clearance: micro-disconnection
Contact - coil distance		
• clearance	≥ 8 mm	
• creepage	≥ 8 mm	

### General data

Operating / release time (typical values)	7 ms / 3 ms	
Electrical life (number of cycles)		
• resistive AC1	> 10 <sup>5</sup>	16 A, 250 V AC
• at incandescent lamp load	> 10 <sup>5</sup>	1000 W, 230 V AC    1 NO, AgSnO <sub>2</sub>
	> 3 x 10 <sup>4</sup>	3000 W, 230 V AC    1 NO, AgSnO <sub>2</sub>
• at halogen lamp load	> 10 <sup>4</sup>	2500 W, 230 V AC    1 NO, AgSnO <sub>2</sub>
• cos φ	see Fig. 2	
• L/R=40 ms	> 10 <sup>5</sup>	0,12 A, 220 V DC
Mechanical life (cycles)	> 3 x 10 <sup>7</sup>	
Dimensions (L x W x H)	IP 40: 29,2 x 13,1 x 25,1 mm IP 67: 29,2 x 13,1 x 25,6 mm	
Weight	18 g	
Ambient temperature	• storage	-40...+85 °C
	• operating	-40...+70 °C
Cover protection category	<b>IP 40</b> or IP 67    PN-EN 60529	
Shock resistance	20 g	
Vibration resistance	10 g 10...150 Hz	
Solder bath temperature	max. 270 °C	
Soldering time	max. 5 s	

The data in bold type pertain to the standard versions of the relays.

❶ For special version - relays in transparent cover - see "Ordering codes".

# RM83

## miniature relays

Coil data - DC voltage version, standard

Table 1

Coil code	Rated voltage V DC	Coil resistance at 20 °C Ω	Acceptable resistance	Coil operating range V DC	
				min. (at 20 °C)	max. (at 20 °C)
1005	5	49	± 10%	3,5	8,9
1006	6	68	± 10%	4,2	10,6
1009	9	110	± 10%	6,3	15,9
<b>1012</b>	<b>12</b>	<b>260</b>	<b>± 10%</b>	<b>8,4</b>	<b>21,2</b>
1018	18	550	± 10%	12,6	31,8
<b>1024</b>	<b>24</b>	<b>1 100</b>	<b>± 10%</b>	<b>16,8</b>	<b>42,5</b>
1036	36	2 100	± 10%	25,2	63,7
1048	48	4 400	± 10%	33,6	85,0
1060	60	7 000	± 10%	42,0	106,2
1110	110	13 000	± 10%	77,0	140,0

The data in bold type pertain to the standard versions of the relays.

Coil data - DC voltage version, sensitive

Table 2

Coil code	Rated voltage V DC	Coil resistance at 20 °C Ω	Acceptable resistance	Coil operating range V DC	
				min. (at 20 °C)	max. (at 20 °C)
S110	110	20 500	± 10%	77,0	188,0

### Dimensions

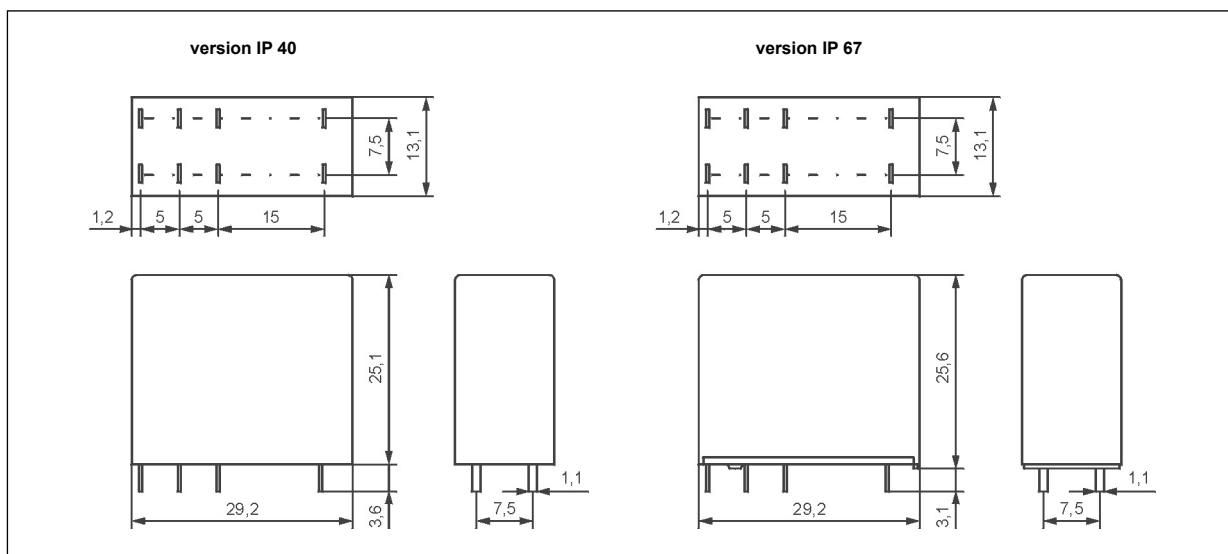

### Connection diagrams (pin side view)

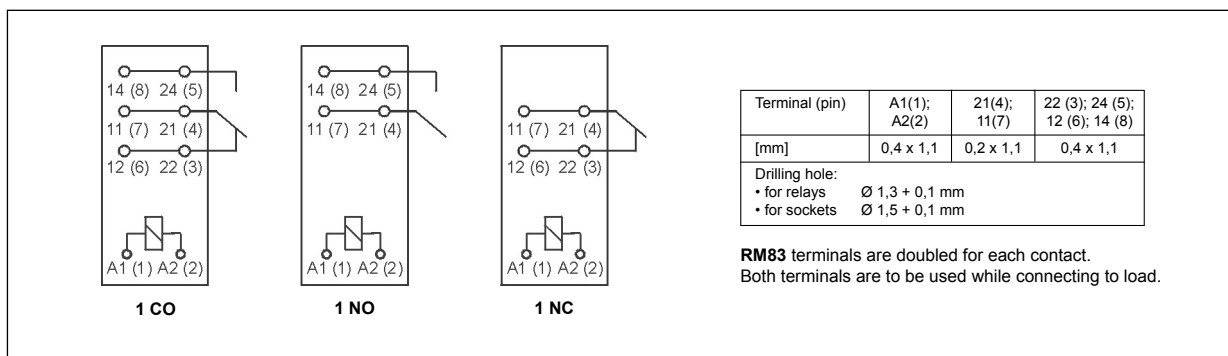

# RM83

## miniature relays

**Electrical life at AC resistive load.**  
Switching frequency: 600 cycles/hour

Fig. 1

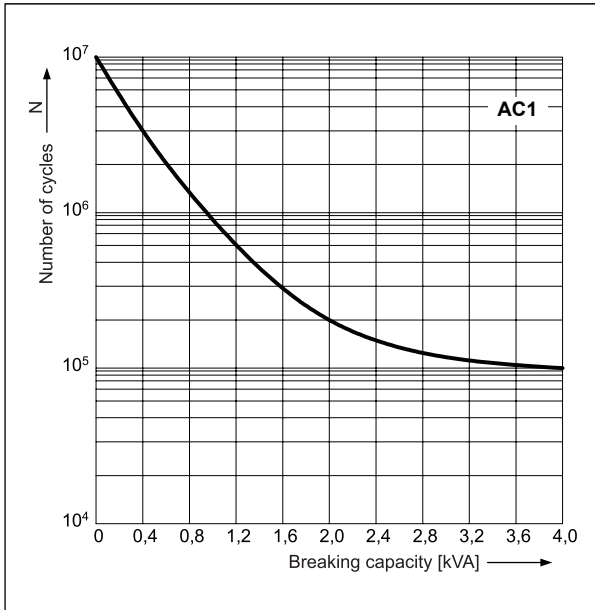

**Electrical life reduction factor**  
at AC inductive load

Fig. 2

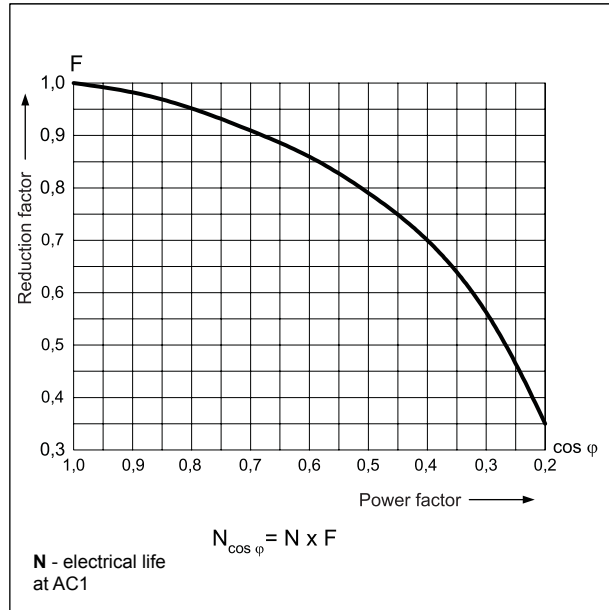

**Max. DC resistive load breaking capacity**

Fig. 3

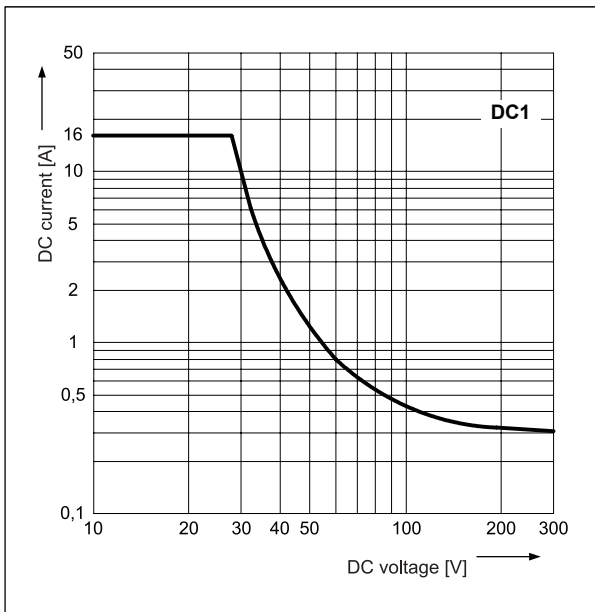

### Mounting

Relays **RM83** are designed for:

- direct PCB mounting
- plug-in sockets for PCB mounting **EC 50** with clip **MP25-2**, **MH25-2**, **GD-0025**, **RM81-0001**; plug-in sockets **PW80** with clip **MH25-2**, **GD-0025**, **RM81-0001**; plug-in sockets **GD50** with clip **MP25-2**, **GD-0025**, **MH25-2**, **RM81-0001**.

# RM83

## miniature relays

### Pinout (solder side view)

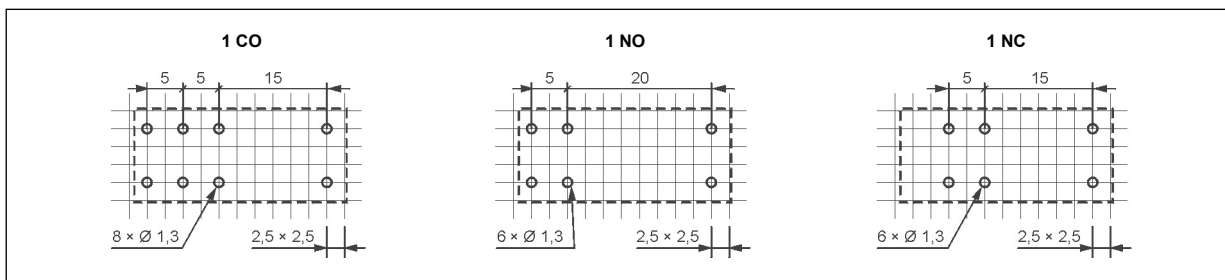

### Ordering codes

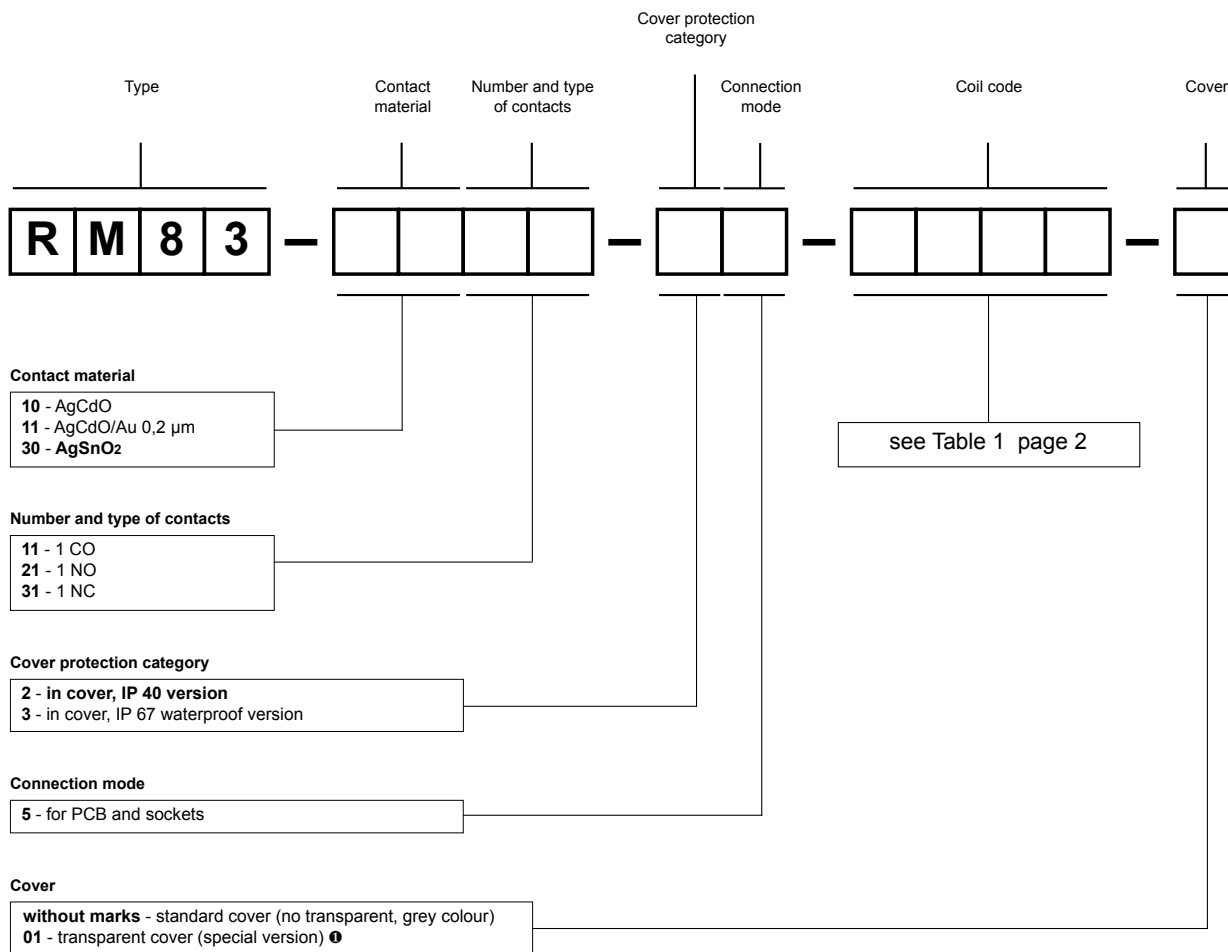

Examples of ordering code:

**RM83-3011-25-1024**

relay **RM83**, for PCB and sockets, one changeover contact, contact material AgSnO<sub>2</sub>, coil voltage 24 V DC, in standard cover (no transparent, grey colour) IP 40

**RM83-3011-25-S110**

relay **RM83**, for PCB and sockets, one changeover contact, contact material AgSnO<sub>2</sub>, sensitive coil voltage 110 V DC, in standard cover (no transparent, grey colour) IP 40

**RM83-3021-35-1012-01**

relay **RM83**, for PCB and sockets, one normally open contact, contact material AgSnO<sub>2</sub>, coil voltage 12 V DC, in transparent cover (special version) IP 67

# Plug-in sockets and accessories

## EC 50

For RM84, RM85, RM85 inrush, RM85 105 °C sensitive, RMB841, RMB851, RM87L, RM87L sensitive, RM87P, RM87P sensitive, RM83, RM94

For PCB  
31,3 x 12,7 x 9 mm  
Two poles, 5 mm pinout  
8 A, 300 V AC

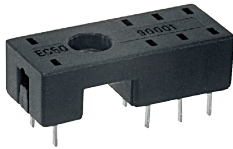

### Pinout

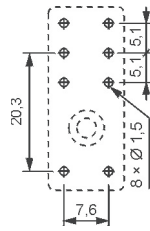

### Dimensions

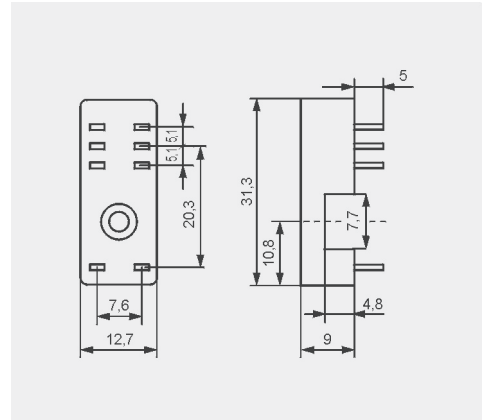

## PW80

For RM84, RM85, RM85 inrush, RM85 105 °C sensitive, RMB841, RMB851, RM87L, RM87L sensitive, RM87P, RM87P sensitive, RM83, RM94

For PCB  
34,6 x 12,9 x 6,6 mm  
Two poles, 5 mm pinout  
8 A, 250 V AC

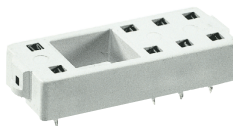

### Pinout

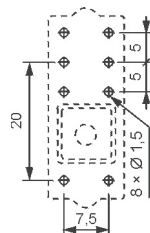

### Dimensions

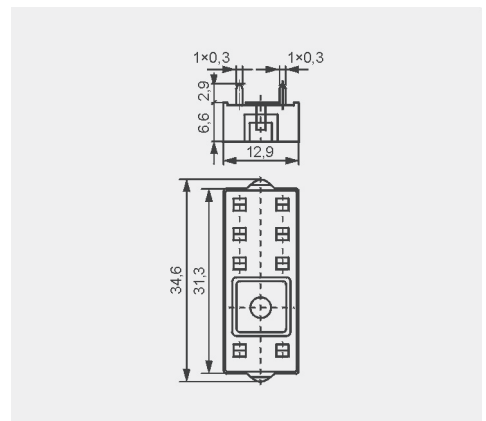

## GD50

For RM84, RM85, RM85 inrush, RM85 105 °C sensitive, RMB841, RMB851, RM87L, RM87L sensitive, RM87P, RM87P sensitive, RM83, RM94

For PCB  
31,5 x 13 x 9 mm  
Two poles, 5 mm pinout  
8 A, 300 V AC



### Pinout

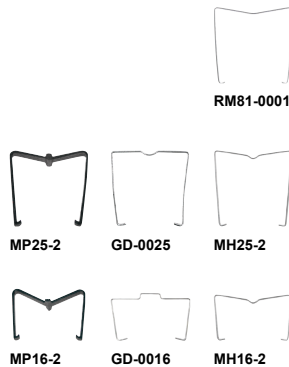
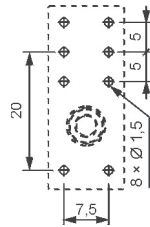

### Dimensions

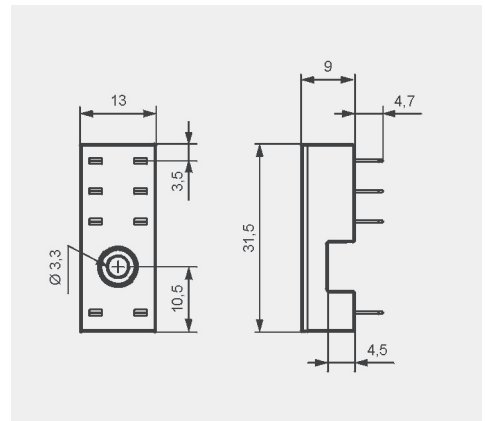

### PRECAUTIONS:

1. Ensure that the parameters of the product described in its specification provide a safety margin for the appropriate operation of the device or system and never use the product in circumstances which exceed the parameters of the product. 2. Never touch any live parts of the device. 3. Ensure that the product has been connected correctly. An incorrect connection may cause malfunction, excessive heating or risk of fire. 4. In case of any risk of any serious material loss or death or injuries of humans or animals, the devices or systems shall be designed so to equip them with double safety system to guarantee their reliable operation.

## X-ON Electronics

Largest Supplier of Electrical and Electronic Components

*Click to view similar products for [General Purpose Relays](#) category:*

*Click to view products by [Relpol](#) manufacturer:*

Other Similar products are found below :

[PCN-105D3MH,000](#) [59641F200](#) [5JO-1000CD-SIL](#) [LY1SAC110120](#) [5X827E](#) [5X837F](#) [5X840F](#) [5X842F](#) [5X848E](#) [LY2N-AC120](#) [LY2S-AC220/240](#) [LY2-US-AC120](#) [LY3-US-AC120](#) [LY4F-UA-DC12](#) [LY4F-UA-DC24](#) [LY4F-US-AC120](#) [LY4F-US-AC240](#) [LY4F-US-DC24](#) [LY4F-VD-AC110](#) [LYQ20DC12](#) [M115C60](#) [M115N010](#) [M115N0150](#) [6031007G](#) [603-12D](#) [61211T0B4](#) [61212T400](#) [61222Q400](#) [61243B600](#) [61243C500](#) [61243Q400](#) [61311BOA2](#) [61311BOA6](#) [61311BOA8](#) [61311C0A2](#) [61311COA1](#) [61311COA6](#) [61311F0A2](#) [61311QOA1](#) [61311QOA4](#) [61311T0D6](#) [61311TOA6](#) [61311TOA7](#) [61311TOB3](#) [61311TOB4](#) [61311U0A6](#) [61312Q600](#) [61312T400](#) [61312T600](#) [61313U200](#)