

Art.-Number: 701723

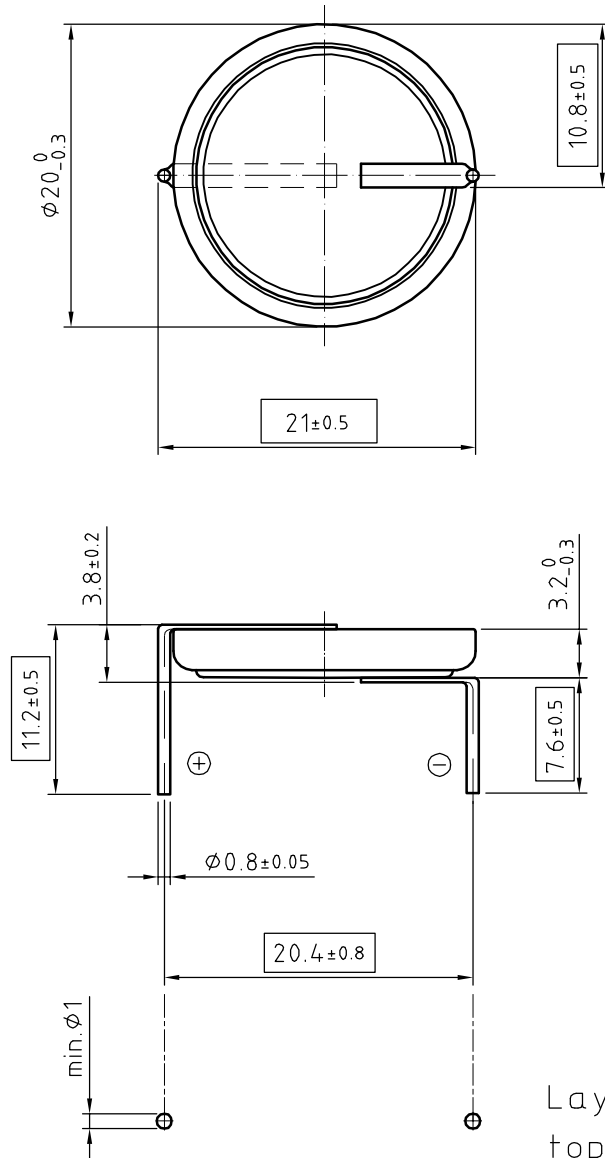

- Samples can deviate in the execution from the serie.

Tab material: CuNi44
All dimensions in mm.

- Dimensions and tolerances can be specified only after the testing of the devices for the mass production definitely

All framed values will be used for dimension checking !

The Products of Renata SA are neither designed nor authorized for use in certain areas of application of environment.
For further details we refer to our webpage www.renata.com/downloads/restriction_of_use

Rev.	①	01.11.14	PWU	Rev.	○			Customer's Approval		
Rev.	②	26.08.19	PWU	Rev.	○			Date		
Rev.	○			Rev.	○			Signature		
Title:							Scale	Drawn	24.11.06	SRI
CR2032 MFR AH1							2:1	Checked		
								Approved		

renata 
batteries

CH-4452 Itingen
Switzerland

3.9167.4-2

X-ON Electronics

Largest Supplier of Electrical and Electronic Components

Click to view similar products for [Coin Cell Battery](#) category:

Other Similar products are found below :

[315](#) [317](#) [329](#) [364](#) [CR1216](#) [CR1220](#) [CR1616](#) [CR1620](#) [CR1632](#) [CR2016](#) [CR2025](#) [CR2032](#) [CR2430](#) [CR2450](#) [CR2450W](#) [CR2032X](#)
[CR2450X](#) [CR2477X](#) [CR2032R](#) [CR2032R-HO6](#) [CR3677X](#) [CR2032W-HO6](#) [CR2477W-HE2](#) [CR2477NRH-LF](#) [CR2477NRV-LF](#)
[CR2325RV-LF](#) [CR2325RH-LF](#) [CR2325FH-LF](#) [449915B](#) [RJD3048HPPV30M](#) [NI-MH-B80H-3A3H](#) [T04/56](#) [413675G](#) [095668F](#) [458980A](#)