

Art.-Number: 701103

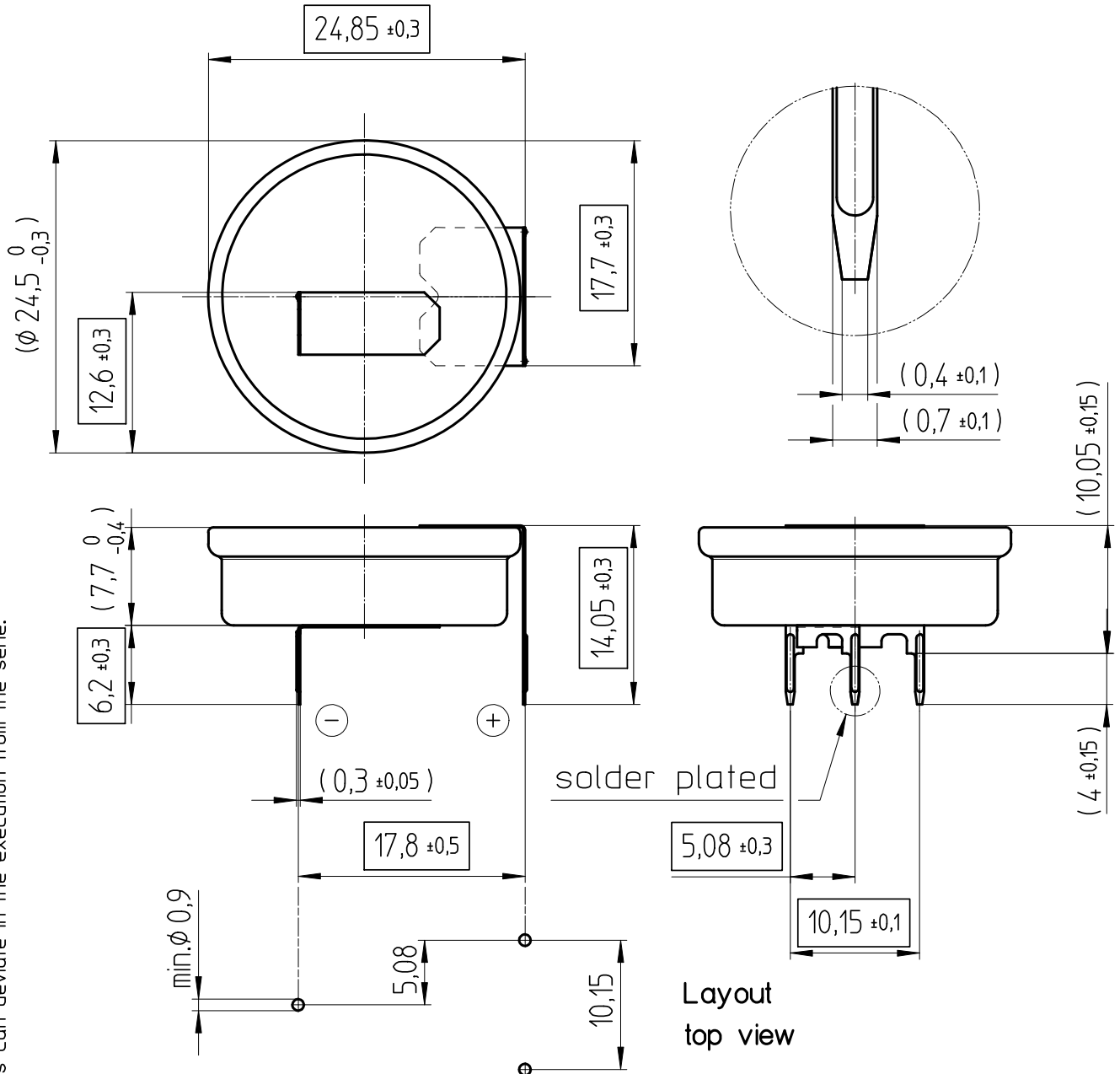

- Samples can deviate in the execution from the serie.

Tab material: Stainless steel

All framed values will be used for dimension checking !

The Products of Renata SA are neither designed nor authorized for use in certain areas of application of environment. For further details we refer to our webpage: [www.renata.com/downloads/restriction\\_of\\_use](http://www.renata.com/downloads/restriction_of_use)

- Dimensions and tolerances can be specified only after the testing of the devices for the mass production definitely

Rev.	①	13.09.2019	SRi	Rev.	⊙	.	.		Customer's Approval		
Rev.	⊙	.	.	Rev.	⊙	.	.		Date		
Rev.	⊙	.	.	Rev.	⊙	.	.		Signature		
Titel:								Scale 2:1	Drawn	06.01.05	SRi
CR2477NRH-LF									Checked	13.09.19	HSn
									Approved	16.09.19	MDi
				CH-4452 Itingen Switzerland				3.8740.4-1			

## **X-ON Electronics**

Largest Supplier of Electrical and Electronic Components

*Click to view similar products for [Coin Cell Battery](#) category:*

Other Similar products are found below :

[315](#) [317](#) [329](#) [364](#) [CR1216](#) [CR1220](#) [CR1616](#) [CR1620](#) [CR1632](#) [CR2016](#) [CR2025](#) [CR2032](#) [CR2430](#) [CR2450](#) [CR2450W](#) [CR2032X](#)  
[CR2450X](#) [CR2477X](#) [CR2032R](#) [CR2032R-HO6](#) [CR3677X](#) [CR2032W-HO6](#) [CR2477W-HE2](#) [CR2477NRH-LF](#) [CR2477NRV-LF](#)  
[CR2325RV-LF](#) [CR2325RH-LF](#) [CR2325FH-LF](#) [449915B](#) [RJD3048HPPV30M](#) [NI-MH-B80H-3A3H](#) [T04/56](#) [413675G](#) [095668F](#) [458980A](#)