

FEATURES:

- Phase-Lock Loop Clock Distribution
- 10MHz to 133MHz operating frequency
- Distributes one clock input to one bank of five and one bank of four outputs
- Separate output enable for each output bank
- Output Skew < 250ps
- Low jitter <200 ps cycle-to-cycle
- IDT2309-1 for Standard Drive
- IDT2309-1H for High Drive
- No external RC network required
- Operates at 3.3V VDD
- Available in SOIC and TSSOP packages

DESCRIPTION:

The IDT2309 is a high-speed phase-lock loop (PLL) clock buffer, designed to address high-speed clock distribution applications. The zero delay is achieved by aligning the phase between the incoming clock and the output clock, operable within the range of 10 to 133MHz.

The IDT2309 is a 16-pin version of the IDT2305. The IDT2309 accepts one reference input, and drives two banks of four low skew clocks. The -1H version of this device operates at up to 133MHz frequency and has higher drive than the -1 device. All parts have on-chip PLLs which lock to an input clock on the REF pin. The PLL feedback is on-chip and is obtained from the CLKOUT pad. In the absence of an input clock, the IDT2309 enters power down, and the outputs are tri-stated. In this mode, the device will draw less than 25µA.

The IDT2309 is characterized for both Industrial and Commercial operation.

FUNCTIONAL BLOCK DIAGRAM

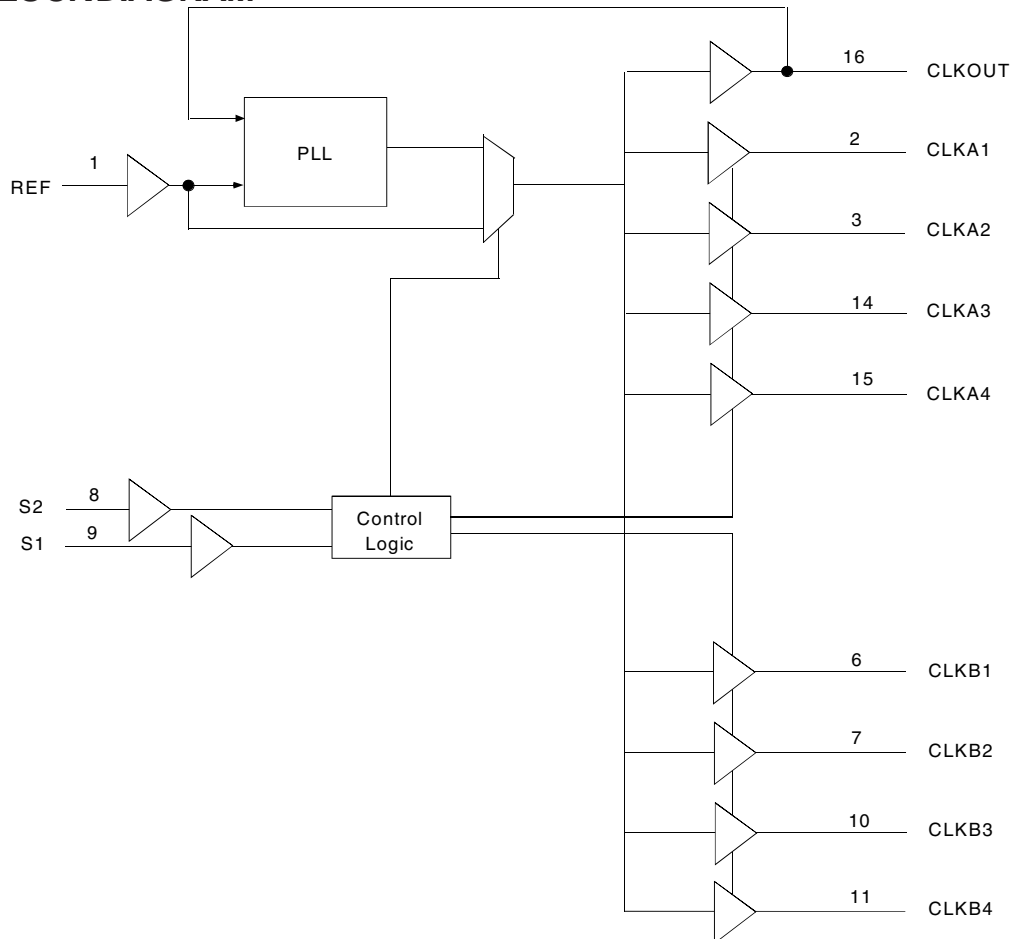

PIN CONFIGURATION

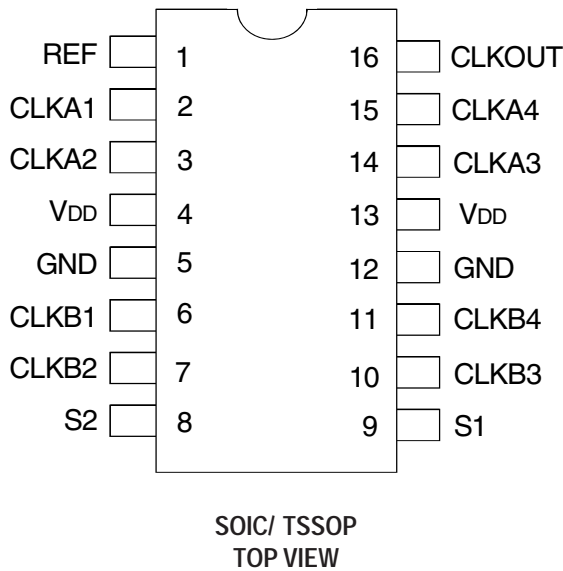

APPLICATIONS:

- SDRAM
- Telecom
- Datacom
- PC Motherboards/Workstations
- Critical Path Delay Designs

ABSOLUTE MAXIMUM RATINGS⁽¹⁾

| Symbol | Rating | Max. | Unit |
|---|----------------------------------|------------------------------|------|
| V _{DD} | Supply Voltage Range | -0.5 to +4.6 | V |
| V _I ⁽²⁾ | Input Voltage Range (REF) | -0.5 to +5.5 | V |
| V _I | Input Voltage Range (except REF) | -0.5 to V _{DD} +0.5 | V |
| I _{IK} (V _I < 0) | Input Clamp Current | -50 | mA |
| I _O (V _O = 0 to V _{DD}) | Continuous Output Current | ±50 | mA |
| V _{DD} or GND | Continuous Current | ±100 | mA |
| T _A = 55°C (in still air) ⁽³⁾ | Maximum Power Dissipation | 0.7 | W |
| T _{STG} | Storage Temperature Range | -65 to +150 | °C |
| Operating Temperature | Commercial Temperature Range | 0 to +70 | °C |
| Operating Temperature | Industrial Temperature Range | -40 to +85 | °C |

NOTES:

1. Stresses greater than those listed under ABSOLUTE MAXIMUM RATINGS may cause permanent damage to the device. This is a stress rating only and functional operation of the device at these or any other conditions above those indicated in the operational sections of this specification is not implied. Exposure to absolute maximum rating conditions for extended periods may affect reliability.
2. The input and output negative-voltage ratings may be exceeded if the input and output clamp-current ratings are observed.
3. The maximum package power dissipation is calculated using a junction temperature of 150°C and a board trace length of 750 mils.

PIN DESCRIPTION

| Pin Name | Pin Number | Type | Functional Description |
|-----------------------|------------|------|--|
| REF | 1 | IN | Input reference clock, 5 Volt tolerant input |
| CLKA1 ⁽¹⁾ | 2 | Out | Output clock for bank A |
| CLKA2 ⁽¹⁾ | 3 | Out | Output clock for bank A |
| V _{DD} | 4, 13 | PWR | 3.3V Supply |
| GND | 5, 12 | GND | Ground |
| CLKB1 ⁽¹⁾ | 6 | Out | Output clock for bank B |
| CLKB2 ⁽¹⁾ | 7 | Out | Output clock for bank B |
| S2 ⁽²⁾ | 8 | IN | Select input Bit 2 |
| S1 ⁽²⁾ | 9 | IN | Select input Bit 1 |
| CLKB3 ⁽¹⁾ | 10 | Out | Output clock for bank B |
| CLKB4 ⁽¹⁾ | 11 | Out | Output clock for bank B |
| CLKA3 ⁽¹⁾ | 14 | Out | Output clock for bank A |
| CLKA4 ⁽¹⁾ | 15 | Out | Output clock for bank A |
| CLKOUT ⁽¹⁾ | 16 | Out | Output clock, internal feedback on this pin |

NOTES:

1. Weak pull down on all outputs.
2. Weak pull ups on these inputs.

FUNCTION TABLE(1)

| S2 | S1 | CLKA | CLKB | CLKOUT ⁽²⁾ | Output Source | PLL Shut Down |
|----|----|-----------|-----------|-----------------------|---------------|---------------|
| L | L | Tri-State | Tri-State | Driven | PLL | N |
| L | H | Driven | Tri-State | Driven | PLL | N |
| H | L | Driven | Driven | Driven | REF | Y |
| H | H | Driven | Driven | Driven | PLL | N |

NOTES:

- H = HIGH Voltage Level.
L = LOW Voltage Level
- This output is driven and has an internal feedback for the PLL. The load on this output can be adjusted to change the skew between the REF and the output.

DC ELECTRICAL CHARACTERISTICS-COMMERCIAL

| Symbol | Parameter | Conditions | | Min. | Max. | Unit |
|--------------------|--------------------------|--|-------------------------------|------|------|------|
| V _{IL} | Input LOW Voltage Level | | | — | 0.8 | V |
| V _{IH} | Input HIGH Voltage Level | | | 2 | — | V |
| I _{IL} | Input LOW Current | V _{IN} = 0V | | — | 50 | μA |
| I _{IH} | Input HIGH Current | V _{IN} = V _{DD} | | — | 100 | μA |
| V _{OL} | Output LOW Voltage | Standard Drive | I _{OL} = 8mA | — | 0.4 | V |
| | | High Drive | I _{OL} = 12mA (-1H) | | | |
| V _{OH} | Output HIGH Voltage | Standard Drive | I _{OH} = -8mA | 2.4 | — | V |
| | | High Drive | I _{OH} = -12mA (-1H) | | | |
| I _{DD_PD} | Power Down Current | REF = 0MHz (S2 = S1 = H) | | — | 12 | μA |
| I _{DD} | Supply Current | Unloaded Outputs at 66.66MHz, SEL inputs at V _{DD} or GND | | — | 32 | mA |

OPERATING CONDITIONS-COMMERCIAL

| Symbol | Parameter | Min. | Max. | Unit |
|-----------------|---|------|------|------|
| V _{DD} | Supply Voltage | 3 | 3.6 | V |
| T _A | Operating Temperature (Ambient Temperature) | 0 | 70 | °C |
| C _L | Load Capacitance < 100MHz | — | 30 | pF |
| | Load Capacitance 100MHz - 133MHz | — | 10 | |
| C _{IN} | Input Capacitance | — | 7 | pF |

SWITCHING CHARACTERISTICS (2309-1)- COMMERCIAL ^(1,2)

| Symbol | Parameter | Conditions | Min. | Typ. | Max. | Unit |
|-------------------|---|--|------|------|------|------|
| t ₁ | Output Frequency | 10pF Load | 10 | — | 133 | MHz |
| | | 30pF Load | 10 | — | 100 | |
| | Duty Cycle = t ₂ ÷ t ₁ | Measured at 1.4V, F _{OUT} = 66.66MHz | 40 | 50 | 60 | % |
| t ₃ | Rise Time | Measured between 0.8V and 2V | — | — | 2.5 | ns |
| t ₄ | Fall Time | Measured between 0.8V and 2V | — | — | 2.5 | ns |
| t ₅ | Output to Output Skew | All outputs equally loaded | — | — | 250 | ps |
| t _{6A} | Delay, REF Rising Edge to CLKOUT Rising Edge ⁽²⁾ | Measured at V _{DD} /2 | — | 0 | ±350 | ps |
| t _{6B} | Delay, REF Rising Edge to CLKOUT Rising Edge ⁽²⁾ | Measured at V _{DD} /2 in PLL bypass mode (IDT2309 only) | 1 | 5 | 8.7 | ns |
| t ₇ | Device-to-Device Skew | Measured at V _{DD} /2 on the CLKOUT pins of devices | — | 0 | 700 | ps |
| t ₁ | Cycle-to-Cycle Jitter | Measured at 66.66MHz, loaded outputs | — | — | 200 | ps |
| t _{LOCK} | PLL Lock Time | Stable power supply, valid clock presented on REF pin | — | — | 1 | ms |

NOTES:

- REF Input has a threshold voltage of V_{DD}/2.
- All parameters specified with loaded outputs.

SWITCHING CHARACTERISTICS (2309-1H) - COMMERCIAL ^(1,2)

| Symbol | Parameter | Conditions | Min. | Typ. | Max. | Unit |
|-------------------|--|--|------|------|------|------|
| t _i | Output Frequency | 10pF Load | 10 | — | 133 | MHz |
| | | 30pF Load | 10 | — | 100 | |
| | Duty Cycle = t ₂ ÷ t ₁ | Measured at 1.4V, F _{OUT} = 66.66MHz | 40 | 50 | 60 | % |
| | Duty Cycle = t ₂ ÷ t ₁ | Measured at 1.4V, F _{OUT} <50MHz | 45 | 50 | 55 | % |
| t _r | Rise Time | Measured between 0.8V and 2V | — | — | 1.5 | ns |
| t _f | Fall Time | Measured between 0.8V and 2V | — | — | 1.5 | ns |
| t _s | Output to Output Skew | All outputs equally loaded | — | — | 250 | ps |
| t _{6A} | Delay, REF Rising Edge to CLKOUT Rising Edge | Measured at V _{DD} /2 | — | 0 | ±350 | ps |
| t _{6B} | Delay, REF Rising Edge to CLKOUT Rising Edge | Measured at V _{DD} /2 in PLL bypass mode (IDT2309 only) | 1 | 5 | 8.7 | ns |
| t ₇ | Device-to-Device Skew | Measured at V _{DD} /2 on the CLKOUT pins of devices | — | 0 | 700 | ps |
| t _s | Output Slew Rate | Measured between 0.8V and 2V using Test Circuit 2 | 1 | — | — | V/ns |
| t _j | Cycle-to-Cycle Jitter | Measured at 66.66MHz, loaded outputs | — | — | 200 | ps |
| t _{LOCK} | PLL Lock Time | Stable power supply, valid clock presented on REF pin | — | — | 1 | ms |

NOTES:

1. REF Input has a threshold voltage of V_{DD}/2.
2. All parameters specified with loaded outputs.

DC ELECTRICAL CHARACTERISTICS - INDUSTRIAL

| Symbol | Parameter | Conditions | Min. | Max. | Unit |
|--------------------|--------------------------|--|------|------|------|
| V _{IL} | Input LOW Voltage Level | | — | 0.8 | V |
| V _{IH} | Input HIGH Voltage Level | | 2 | — | V |
| I _{IL} | Input LOW Current | V _{IN} = 0V | — | 50 | μA |
| I _{IH} | Input HIGH Current | V _{IN} = V _{DD} | — | 100 | μA |
| V _{OL} | Output LOW Voltage | Standard Drive | — | 0.4 | V |
| | | High Drive | | | |
| V _{OH} | Output HIGH Voltage | Standard Drive | 2.4 | — | V |
| | | High Drive | | | |
| I _{DD_PD} | Power Down Current | REF = 0MHz (S ₂ = S ₁ = H) | — | 25 | μA |
| I _{DD} | Supply Current | Unloaded Outputs at 66.66MHz, SEL inputs at V _{DD} or GND | — | 35 | mA |

OPERATING CONDITIONS - INDUSTRIAL

| Symbol | Parameter | Min. | Max. | Unit |
|-----------------|---|------|------|------|
| V _{DD} | Supply Voltage | 3 | 3.6 | V |
| T _A | Operating Temperature (Ambient Temperature) | -40 | +85 | °C |
| C _L | Load Capacitance < 100MHz | — | 30 | pF |
| | Load Capacitance 100MHz - 133MHz | — | 10 | |
| C _{IN} | Input Capacitance | — | 7 | pF |

SWITCHING CHARACTERISTICS (2309-1) - INDUSTRIAL ^(1,2)

| Symbol | Parameter | Conditions | Min. | Typ. | Max. | Unit |
|-------------------|--|--|------|------|------|------|
| t ₁ | Output Frequency | 10pF Load | 10 | — | 133 | MHz |
| | | 30pF Load | 10 | — | 100 | |
| | Duty Cycle = t ₂ ÷ t ₁ | Measured at 1.4V, F _{OUT} = 66.66MHz | 40 | 50 | 60 | % |
| t ₃ | Rise Time | Measured between 0.8V and 2V | — | — | 2.5 | ns |
| t ₄ | Fall Time | Measured between 0.8V and 2V | — | — | 2.5 | ns |
| t ₅ | Output to Output Skew | All outputs equally loaded | — | — | 250 | ps |
| t _{6A} | Delay, REF Rising Edge to CLKOUT Rising Edge | Measured at V _{DD} /2 | — | 0 | ±350 | ps |
| t _{6B} | Delay, REF Rising Edge to CLKOUT Rising Edge | Measured at V _{DD} /2 in PLL bypass mode (IDT2309 only) | 1 | 5 | 8.7 | ns |
| t ₇ | Device-to-Device Skew | Measured at V _{DD} /2 on the CLKOUT pins of devices | — | 0 | 700 | ps |
| t ₁ | Cycle-to-Cycle Jitter | Measured at 66.66MHz, loaded outputs | — | — | 200 | ps |
| t _{LOCK} | PLL Lock Time | Stable power supply, valid clock presented on REF pin | — | — | 1 | ms |

NOTES:

- REF Input has a threshold voltage of V_{DD}/2.
- All parameters specified with loaded outputs.

SWITCHING CHARACTERISTICS (2309-1H) - INDUSTRIAL ^(1,2)

| Symbol | Parameter | Conditions | Min. | Typ. | Max. | Unit |
|-------------------|--|--|------|------|------|------|
| t ₁ | Output Frequency | 10pF Load | 10 | — | 133 | MHz |
| | | 30pF Load | 10 | — | 100 | |
| | Duty Cycle = t ₂ ÷ t ₁ | Measured at 1.4V, F _{OUT} = 66.66MHz | 40 | 50 | 60 | % |
| | Duty Cycle = t ₂ ÷ t ₁ | Measured at 1.4V, F _{OUT} < 50MHz | 45 | 50 | 55 | % |
| t ₃ | Rise Time | Measured between 0.8V and 2V | — | — | 1.5 | ns |
| t ₄ | Fall Time | Measured between 0.8V and 2V | — | — | 1.5 | ns |
| t ₅ | Output to Output Skew | All outputs equally loaded | — | — | 250 | ps |
| t _{6A} | Delay, REF Rising Edge to CLKOUT Rising Edge | Measured at V _{DD} /2 | — | 0 | ±350 | ps |
| t _{6B} | Delay, REF Rising Edge to CLKOUT Rising Edge | Measured at V _{DD} /2 in PLL bypass mode (IDT2309 only) | 1 | 5 | 8.7 | ns |
| t ₇ | Device-to-Device Skew | Measured at V _{DD} /2 on the CLKOUT pins of devices | — | 0 | 700 | ps |
| t ₈ | Output Slew Rate | Measured between 0.8V and 2V using Test Circuit 2 | 1 | — | — | V/ns |
| t ₁ | Cycle-to-Cycle Jitter | Measured at 66.66MHz, loaded outputs | — | — | 200 | ps |
| t _{LOCK} | PLL Lock Time | Stable power supply, valid clock presented on REF pin | — | — | 1 | ms |

NOTES:

- REF Input has a threshold voltage of V_{DD}/2.
- All parameters specified with loaded outputs.

ZERO DELAY AND SKEW CONTROL

All outputs should be uniformly loaded in order to achieve Zero I/O Delay. Since the CLKOUT pin is the internal feedback for the PLL, its relative loading can affect and adjust the input/output delay. The Output Load Difference diagram illustrates the PLL's relative loading with respect to the other outputs that can adjust the Input-Output (I/O) Delay.

For designs utilizing zero I/O Delay, all outputs including CLKOUT must be equally loaded. Even if the output is not used, it must have a capacitive load equal to that on the other outputs in order to obtain true zero I/O Delay. If I/O Delay adjustments are needed, use the Output Load Difference diagram to calculate loading differences between the CLKOUT pin and other outputs. For zero output-to-output skew, all outputs must be loaded equally.

REF TO CLKA/CLKB RELAY vs. OUTPUT LOAD DIFFERENCE BETWEEN CLKOUT PIN AND CLKA/CLKB PINS

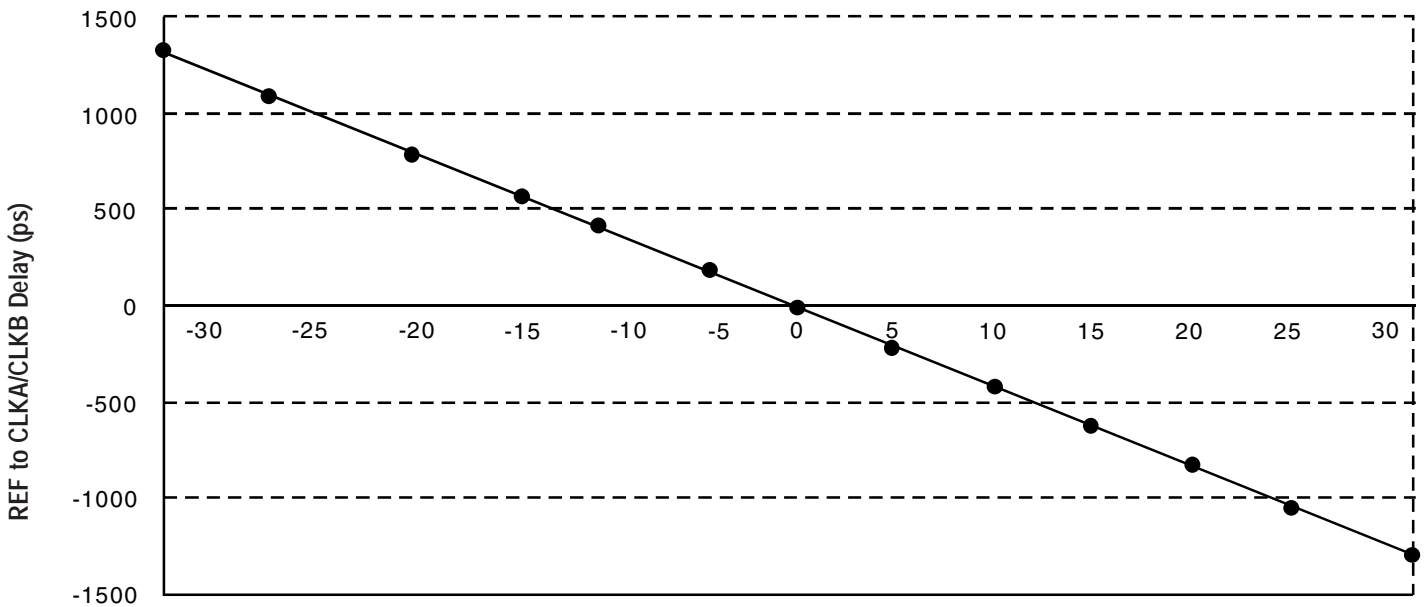

OUTPUT LOAD DIFFERENCE BETWEEN CLKOUT PIN AND CLKA/CLKB PINS (pF)

SWITCHING WAVEFORMS

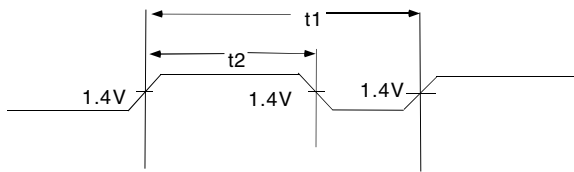

Duty Cycle Timing

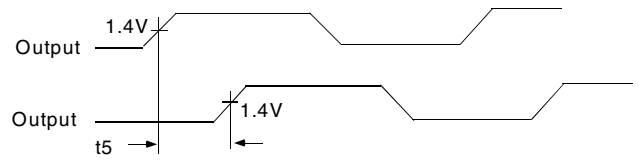

Output to Output Skew

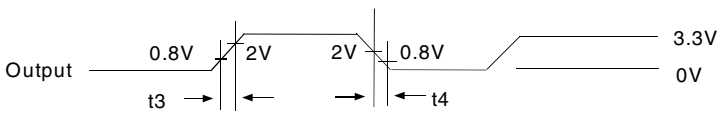

All Outputs Rise/Fall Time

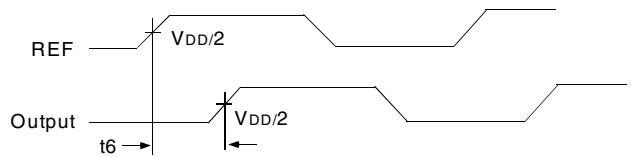

Input to Output Propagation Delay

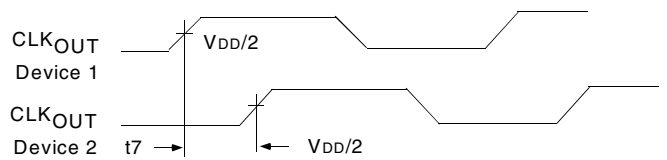

Device to Device Skew

TEST CIRCUITS

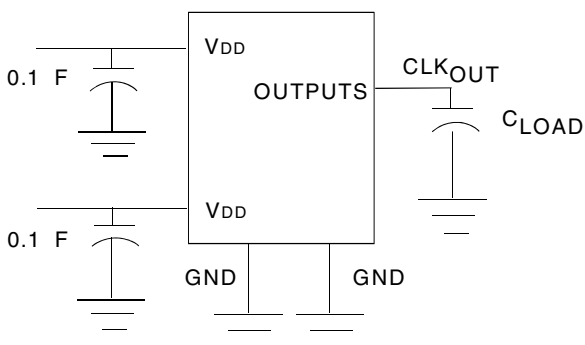

Test Circuit 1 (all Parameters Except t8)

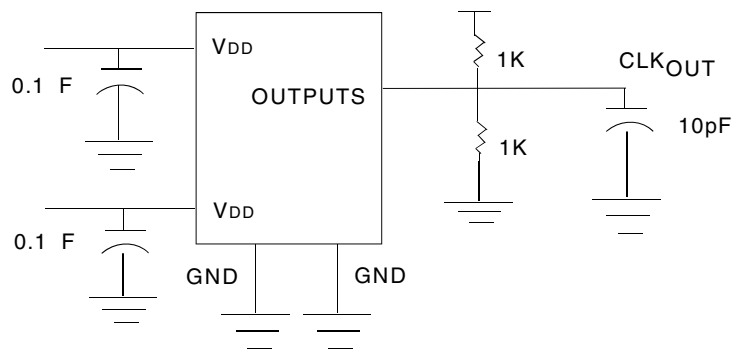

Test Circuit 2 (t8, Output Slew Rate On -1H Devices)

TYPICAL DUTY CYCLE⁽¹⁾ AND I_{DD} TRENDS⁽²⁾ FOR IDT2309-1

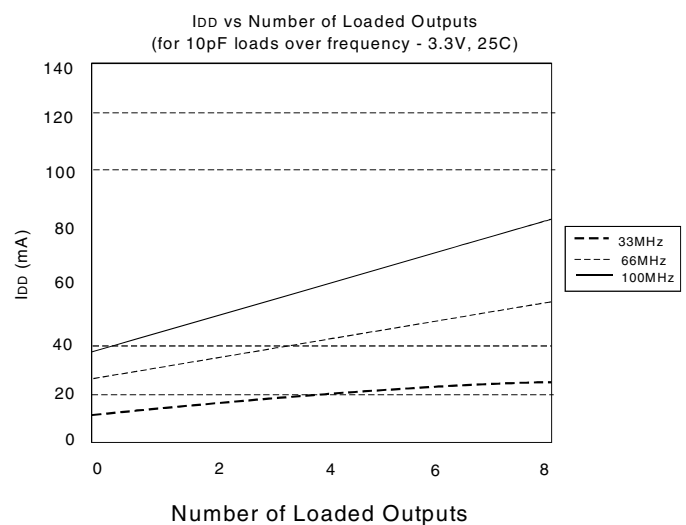
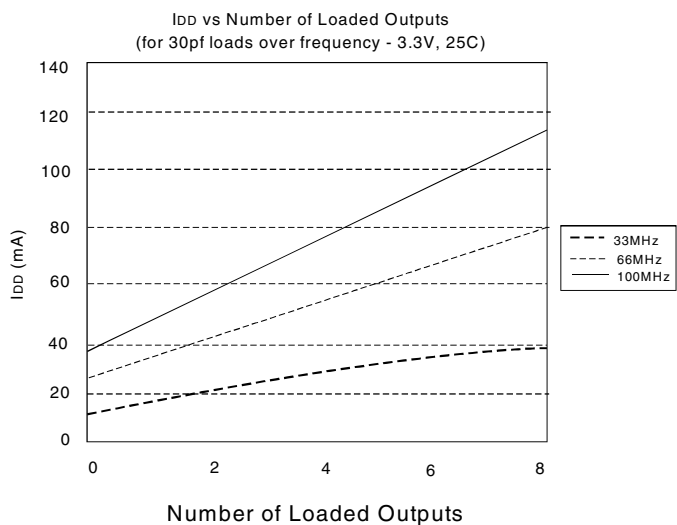
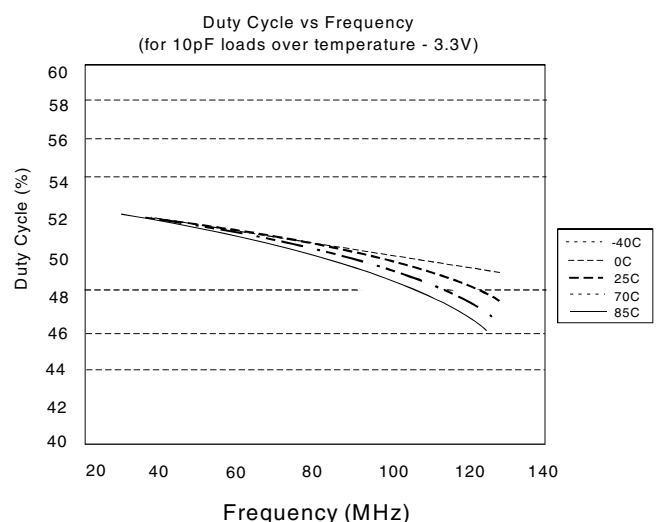
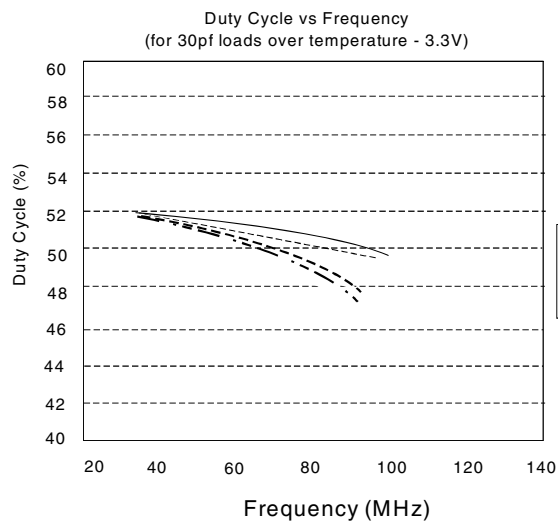
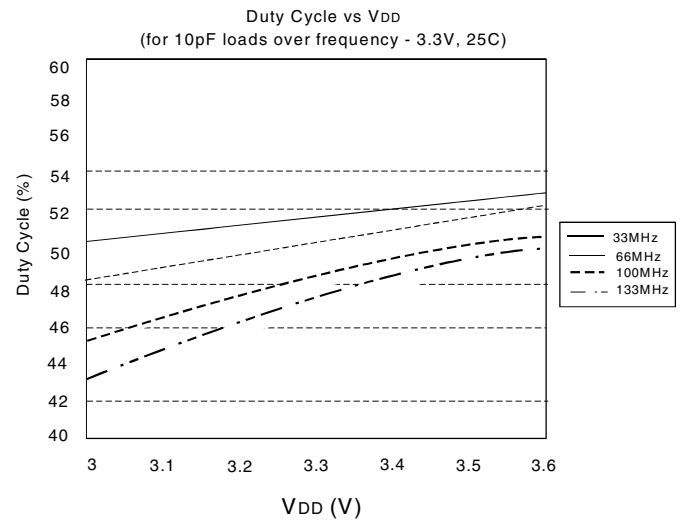
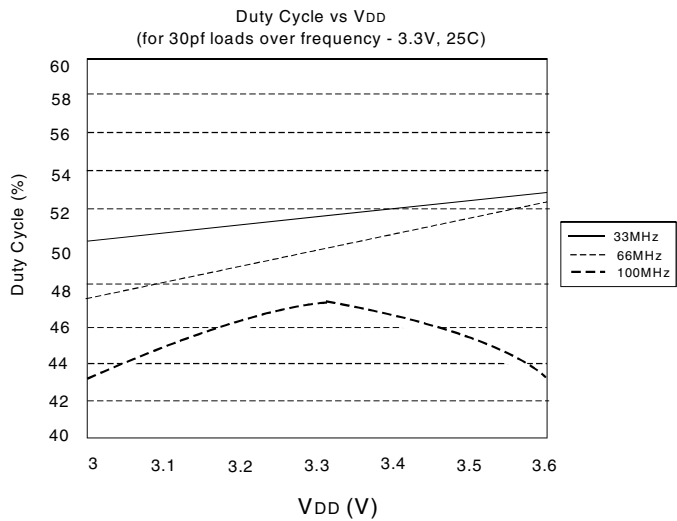

NOTES:

- Duty Cycle is taken from typical chip measured at 1.4V.
- I_{DD} data is calculated from $I_{DD} = I_{CORE} + nCVf$, where I_{CORE} is the unloaded current. (n = Number of outputs; C = Capacitance load per output (F); V = Supply Voltage (V); f = Frequency (Hz))

TYPICAL DUTY CYCLE⁽¹⁾ AND I_{DD} TRENDS⁽²⁾ FOR IDT2309-1H

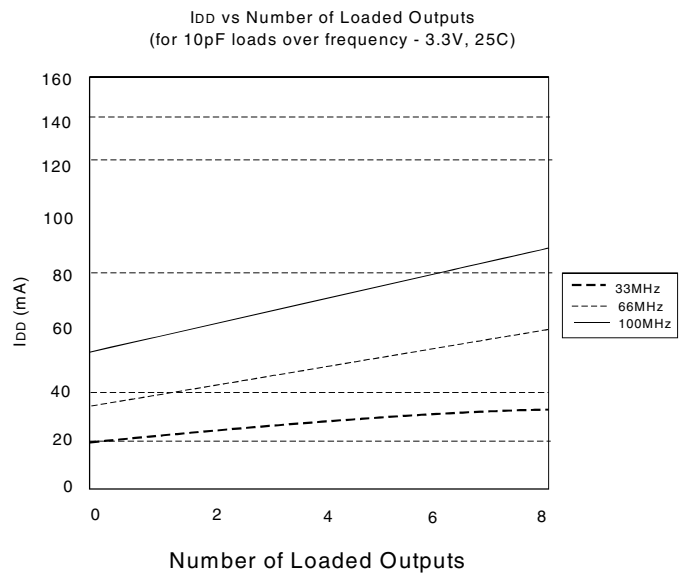
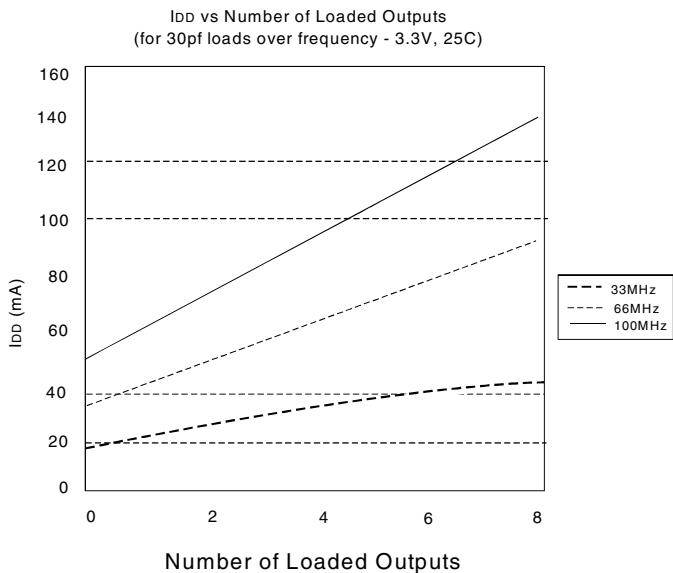
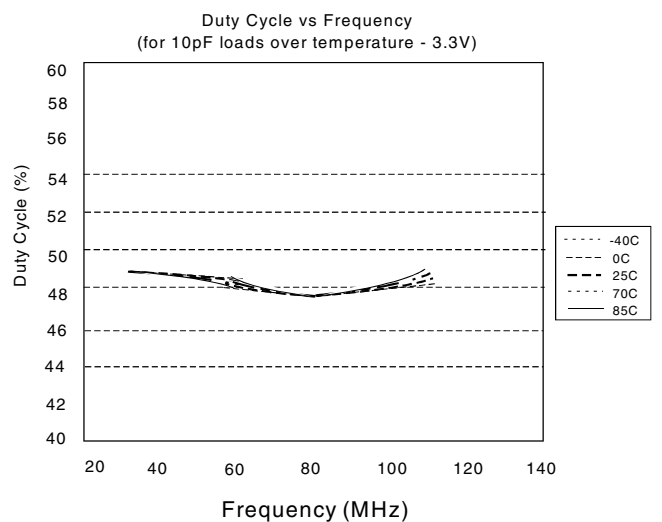
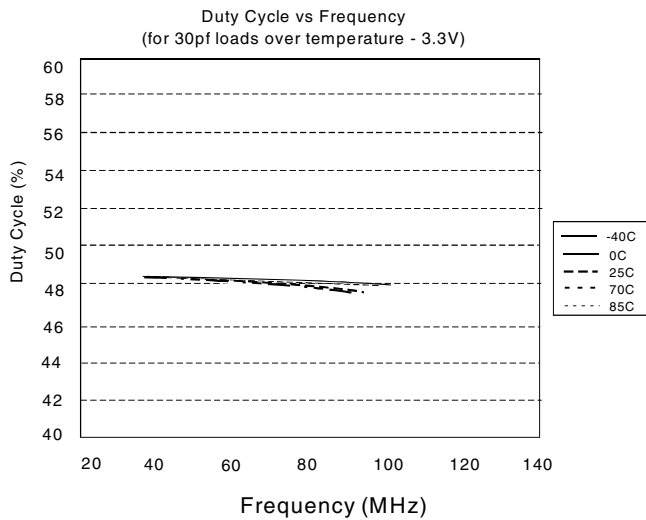
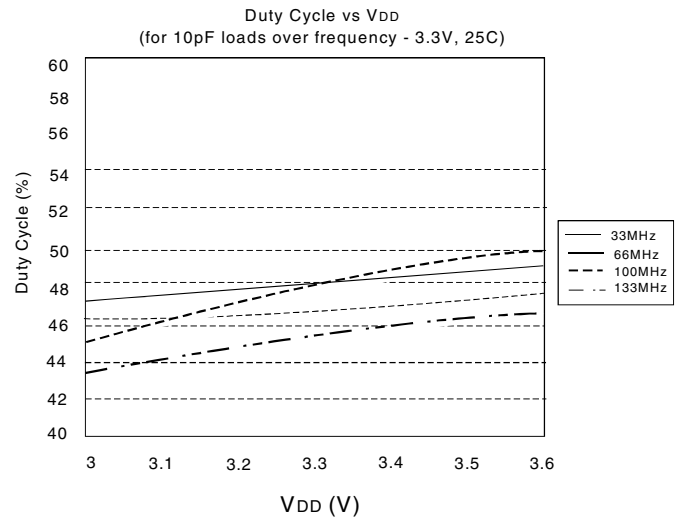
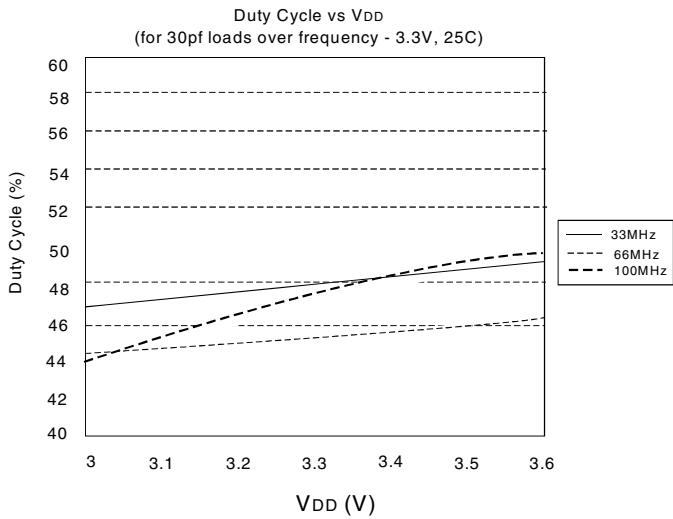

NOTES:

- Duty Cycle is taken from typical chip measured at 1.4V.
- I_{DD} data is calculated from $I_{DD} = I_{CORE} + nCfV$, where I_{CORE} is the unloaded current. (n = Number of outputs; C = Capacitance load per output (F); V = Supply Voltage (V); f = Frequency (Hz))

ORDERING INFORMATION

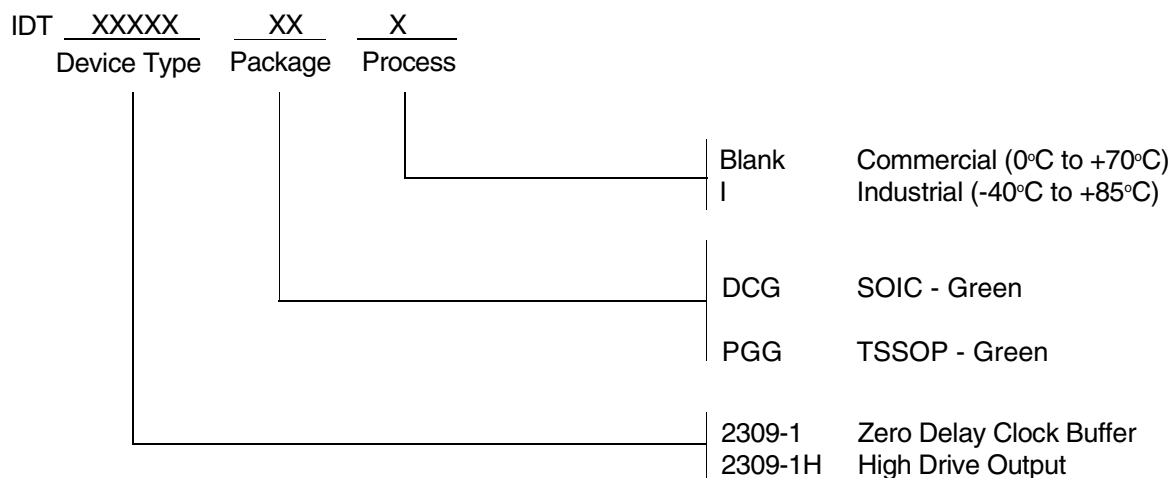

| Ordering Code | Package Type | Operating Range |
|----------------|--------------|-----------------|
| IDT2309-1DCG | 16-Pin SOIC | Commercial |
| IDT2309-1DCGI | 16-Pin SOIC | Industrial |
| IDT2309-1HDCG | 16-Pin SOIC | Commercial |
| IDT2309-1HDCGI | 16-Pin SOIC | Industrial |
| IDT2309-1HPG | 16-Pin TSSOP | Commercial |
| IDT2309-1HPGG | 16-Pin TSSOP | Commercial |
| IDT2309-1HPGI | 16-Pin TSSOP | Industrial |
| IDT2309-1HPGGI | 16-Pin TSSOP | Industrial |

IMPORTANT NOTICE AND DISCLAIMER

RENESAS ELECTRONICS CORPORATION AND ITS SUBSIDIARIES (“RENESAS”) PROVIDES TECHNICAL SPECIFICATIONS AND RELIABILITY DATA (INCLUDING DATASHEETS), DESIGN RESOURCES (INCLUDING REFERENCE DESIGNS), APPLICATION OR OTHER DESIGN ADVICE, WEB TOOLS, SAFETY INFORMATION, AND OTHER RESOURCES “AS IS” AND WITH ALL FAULTS, AND DISCLAIMS ALL WARRANTIES, EXPRESS OR IMPLIED, INCLUDING, WITHOUT LIMITATION, ANY IMPLIED WARRANTIES OF MERCHANTABILITY, FITNESS FOR A PARTICULAR PURPOSE, OR NON-INFRINGEMENT OF THIRD PARTY INTELLECTUAL PROPERTY RIGHTS.

These resources are intended for developers skilled in the art designing with Renesas products. You are solely responsible for (1) selecting the appropriate products for your application, (2) designing, validating, and testing your application, and (3) ensuring your application meets applicable standards, and any other safety, security, or other requirements. These resources are subject to change without notice. Renesas grants you permission to use these resources only for development of an application that uses Renesas products. Other reproduction or use of these resources is strictly prohibited. No license is granted to any other Renesas intellectual property or to any third party intellectual property. Renesas disclaims responsibility for, and you will fully indemnify Renesas and its representatives against, any claims, damages, costs, losses, or liabilities arising out of your use of these resources. Renesas' products are provided only subject to Renesas' Terms and Conditions of Sale or other applicable terms agreed to in writing. No use of any Renesas resources expands or otherwise alters any applicable warranties or warranty disclaimers for these products.

(Rev.1.0 Mar 2020)

Corporate Headquarters

TOYOSU FORESIA, 3-2-24 Toyosu,
Koto-ku, Tokyo 135-0061, Japan
www.renesas.com

Contact Information

For further information on a product, technology, the most up-to-date version of a document, or your nearest sales office, please visit:
www.renesas.com/contact/

Trademarks

Renesas and the Renesas logo are trademarks of Renesas Electronics Corporation. All trademarks and registered trademarks are the property of their respective owners.

X-ON Electronics

Largest Supplier of Electrical and Electronic Components

Click to view similar products for [Clock Buffer](#) category:

Click to view products by [Renesas](#) manufacturer:

Other Similar products are found below :

[MPC962309EJ-1H](#) [NB4N121KMNG](#) [IDT49FCT805ASO](#) [MK2308S-1HILF](#) [PL133-27GI-R](#) [NB3L02FCT2G](#) [NB3L03FCT2G](#)
[ZL40203LDG1](#) [ZL40200LDG1](#) [ZL40205LDG1](#) [9FG1200DF-1LF](#) [9FG1001BGLF](#) [ZL40202LDG1](#) [PI49FCT20802QE](#) [SL2305SC-1T](#)
[PI6C4931502-04LIE](#) [NB7L1008MNG](#) [NB7L14MN1G](#) [PI49FCT20807QE](#) [PI6C4931502-04LIEX](#) [ZL80002QAB1](#) [PI6C4931504-04LIEX](#)
[PI6C10806BLEX](#) [ZL40226LDG1](#) [ZL40219LDG1](#) [8T73S208B-01NLGI](#) [SY75578LMG](#) [PI49FCT32805QEX](#) [PL133-27GC-R](#)
[MC10LVEP11DG](#) [MC10EP11DTG](#) [MC100LVEP11DG](#) [MC100E111FNG](#) [MC100EP11DTG](#) [NB6N11SMNG](#) [NB7L14MMNG](#)
[NB6L11MMNG](#) [NB6L14MMNR2G](#) [NB6L611MNG](#) [PL123-02NGI-R](#) [NB3N111KMNR4G](#) [ADCLK944BCPZ-R7](#) [ZL40217LDG1](#)
[NB7LQ572MNG](#) [HMC940LC4BTR](#) [ADCLK946BCPZ-REEL7](#) [ADCLK946BCPZ](#) [ADCLK846BCPZ-REEL7](#) [ADCLK854BCPZ-REEL7](#)
[ADCLK905BCPZ-R2](#)