

HD74LV1GW17A

R04DS0033EJ0300

Rev.3.00

Dual Buffer with Schmitt Trigger Inputs

Jan 10, 2014

Description

The HD74LV1GW17A has dual buffer with schmitt-trigger input in a 6 pin package. Low voltage and high-speed operation is suitable for the battery powered products (e.g., notebook computers), and the low power consumption extends the battery life.

Features

- The basic gate function is lined up as Renesas uni logic series.
- Supplied on emboss taping for high-speed automatic mounting.
- Supply voltage range : 1.65 to 5.5 V
Operating temperature range : -40 to +85°C
- All inputs V_{IH} (Max.) = 5.5 V (@ V_{CC} = 0 V to 5.5 V)
All outputs V_O (Max.) = 5.5 V (@ V_{CC} = 0 V)
- Output current ± 6 mA (@ V_{CC} = 3.0 V to 3.6 V), ± 12 mA (@ V_{CC} = 4.5 V to 5.5 V)
- All the logical input has hysteresis voltage for the slow transition.
- Ordering Information

Part Name	Package Type	Package Code (Previous Code)	Package Abbreviation	Taping Abbreviation (Quantity)
HD74LV1GW17ACME	CMPAK-6 pin	PTSP0006JA-A (CMPAK-6V)	CM	E (3,000 pcs / Reel)

Outline and Article Indication

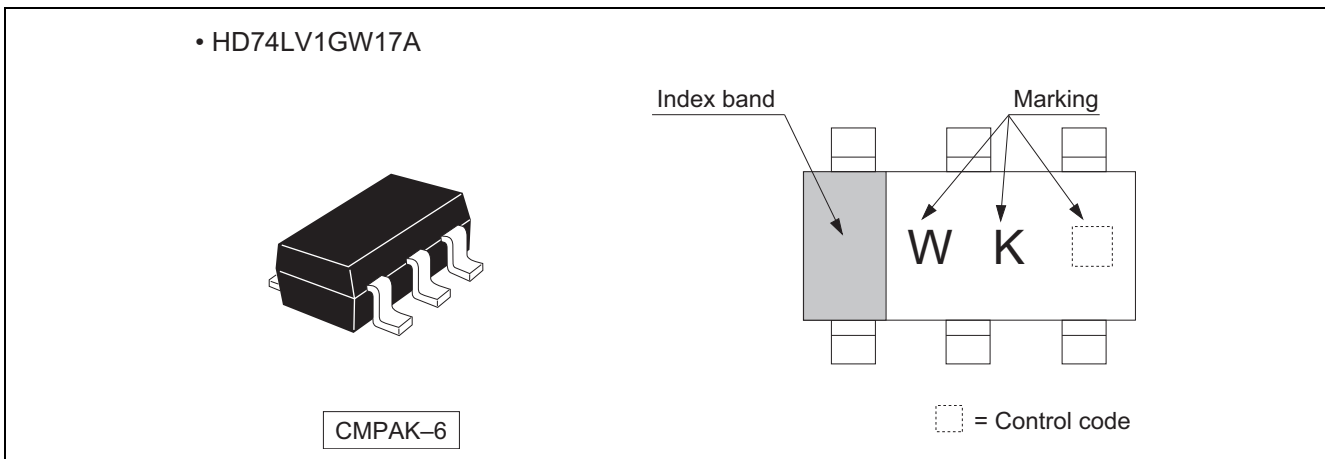

Function Table

Input A	Output Y
H	H
L	L

H : High level

L : Low level

Pin Arrangement

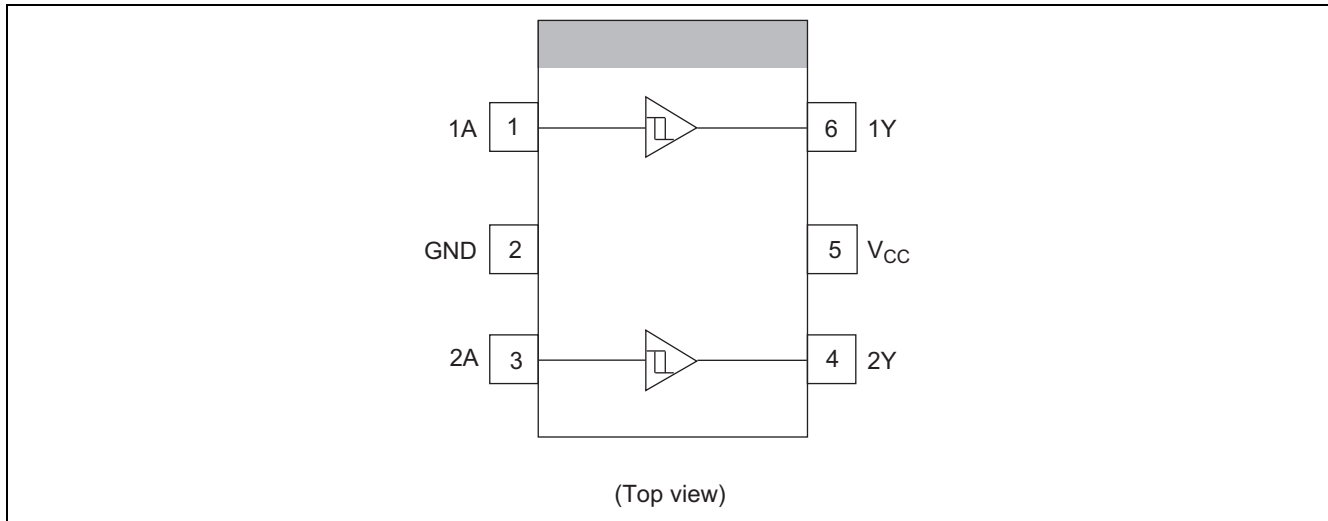

Absolute Maximum Ratings

Item	Symbol	Ratings	Unit	Test Conditions
Supply voltage range	V_{CC}	-0.5 to 7.0	V	
Input voltage range ^{*1}	V_I	-0.5 to 7.0	V	
Output voltage range ^{*1, 2}	V_O	-0.5 to $V_{CC} + 0.5$	V	Output : H or L
		-0.5 to 7.0		V_{CC} : OFF
Input clamp current	I_{IK}	-20	mA	$V_I < 0$
Output clamp current	I_{OK}	± 50	mA	$V_O < 0$ or $V_O > V_{CC}$
Continuous output current	I_O	± 25	mA	$V_O = 0$ to V_{CC}
Continuous current through V_{CC} or GND	I_{CC} or I_{GND}	± 50	mA	
Maximum power dissipation at $T_a = 25^\circ\text{C}$ (in still air) ^{*3}	P_T	200	mW	
Storage temperature	T_{stg}	-65 to 150	$^\circ\text{C}$	

Notes: The absolute maximum ratings are values, which must not individually be exceeded, and furthermore no two of which may be realized at the same time.

1. The input and output voltage ratings may be exceeded if the input and output clamp-current ratings are observed.
2. This value is limited to 5.5 V maximum.
3. The maximum package power dissipation was calculated using a junction temperature of 150 $^\circ\text{C}$.

Recommended Operating Conditions

Item	Symbol	Min	Max	Unit	Conditions
Supply voltage range	V_{CC}	1.65	5.5	V	
Input voltage range	V_I	0	5.5	V	
Output voltage range	V_O	0	V_{CC}	V	
Output current	I_{OL}	—	1	mA	$V_{CC} = 1.65$ to 1.95 V
		—	2		$V_{CC} = 2.3$ to 2.7 V
		—	6		$V_{CC} = 3.0$ to 3.6 V
		—	12		$V_{CC} = 4.5$ to 5.5 V
	I_{OH}	—	-1		$V_{CC} = 1.65$ to 1.95 V
		—	-2		$V_{CC} = 2.3$ to 2.7 V
		—	-6		$V_{CC} = 3.0$ to 3.6 V
		—	-12		$V_{CC} = 4.5$ to 5.5 V
Operating free-air temperature	T_a	-40	85	°C	

Note: Unused or floating inputs must be held high or low.

Electrical Characteristics

$T_a = -40$ to 85°C

Item	Symbol	V_{CC} (V) *	Min	Typ	Max	Unit	Test condition	
Threshold voltage	V_T^+	1.65 to 1.95	—	—	$V_{CC} \times 0.75$	V		
		2.5	—	—	1.75			
		3.3	—	—	2.31			
		5.0	—	—	3.50			
	V_T^-	1.65 to 1.95	$V_{CC} \times 0.25$	—	—			—
		2.5	0.75	—	—			—
		3.3	0.99	—	—			—
		5.0	1.5	—	—			—
	ΔV_T	1.65 to 1.95	0.1	—	—			$V_{CC} \times 0.4$
		2.5	0.25	—	—			1.0
		3.3	0.33	—	—			1.32
		5.0	0.5	—	—			2.0
Output voltage	V_{OH}	Min to Max	$V_{CC} - 0.1$	—	—	V	$I_{OH} = -50 \mu\text{A}$	
		1.65	1.4	—	—		$I_{OH} = -1 \text{ mA}$	
		2.3	2.0	—	—		$I_{OH} = -2 \text{ mA}$	
		3.0	2.48	—	—		$I_{OH} = -6 \text{ mA}$	
		4.5	3.8	—	—		$I_{OH} = -12 \text{ mA}$	
	V_{OL}	Min to Max	—	—	—		0.1	$I_{OL} = 50 \mu\text{A}$
		1.65	—	—	—		0.3	$I_{OL} = 1 \text{ mA}$
		2.3	—	—	—		0.4	$I_{OL} = 2 \text{ mA}$
		3.0	—	—	—		0.44	$I_{OL} = 6 \text{ mA}$
		4.5	—	—	—		0.55	$I_{OL} = 12 \text{ mA}$
Input current	I_{IN}	0 to 5.5	—	—	± 1	μA	$V_{IN} = 5.5 \text{ V}$ or GND	
Quiescent supply current	I_{CC}	5.5	—	—	10	μA	$V_{IN} = V_{CC}$ or GND, $I_O = 0$	
Output leakage current	I_{OFF}	0	—	—	5	μA	V_{IN} or $V_O = 0$ to 5.5 V	
Input capacitance	C_{IN}	3.3	—	3.0	—	pF	$V_{IN} = V_{CC}$ or GND	

Note: For conditions shown as Min or Max, use the appropriate values under recommended operating conditions.

Switching Characteristics

$$V_{CC} = 1.8 \pm 0.15 \text{ V}$$

Item	Symbol	Ta = 25°C			Ta = -40 to 85°C		Unit	Test Conditions	FROM (Input)	TO (Output)
		Min	Typ	Max	Min	Max				
Propagation delay time	t _{PLH}	—	16.8	32.0	1.0	34.0	ns	C _L = 15 pF	A	Y
	t _{PHL}	—	23.8	43.0	1.0	46.0		C _L = 50 pF		

$$V_{CC} = 2.5 \pm 0.2 \text{ V}$$

Item	Symbol	Ta = 25°C			Ta = -40 to 85°C		Unit	Test Conditions	FROM (Input)	TO (Output)
		Min	Typ	Max	Min	Max				
Propagation delay time	t _{PLH}	—	10.5	19.7	1.0	22.0	ns	C _L = 15 pF	A	Y
	t _{PHL}	—	14.0	24.0	1.0	27.0		C _L = 50 pF		

$$V_{CC} = 3.3 \pm 0.3 \text{ V}$$

Item	Symbol	Ta = 25°C			Ta = -40 to 85°C		Unit	Test Conditions	FROM (Input)	TO (Output)
		Min	Typ	Max	Min	Max				
Propagation delay time	t _{PLH}	—	8.3	12.8	1.0	15.0	ns	C _L = 15 pF	A	Y
	t _{PHL}	—	10.8	16.3	1.0	18.5		C _L = 50 pF		

$$V_{CC} = 5.0 \pm 0.5 \text{ V}$$

Item	Symbol	Ta = 25°C			Ta = -40 to 85°C		Unit	Test Conditions	FROM (Input)	TO (Output)
		Min	Typ	Max	Min	Max				
Propagation delay time	t _{PLH}	—	5.5	8.6	1.0	10.0	ns	C _L = 15 pF	A	Y
	t _{PHL}	—	7.0	10.6	1.0	12.0		C _L = 50 pF		

Operating Characteristics

$$C_L = 50 \text{ pF}$$

Item	Symbol	V _{CC} (V)	Ta = 25°C			Unit	Test Conditions
			Min	Typ	Max		
Power dissipation capacitance	C _{PD}	3.3	—	8.5	—	pF	f = 10 MHz
		5.0	—	10.0	—		

Test Circuit

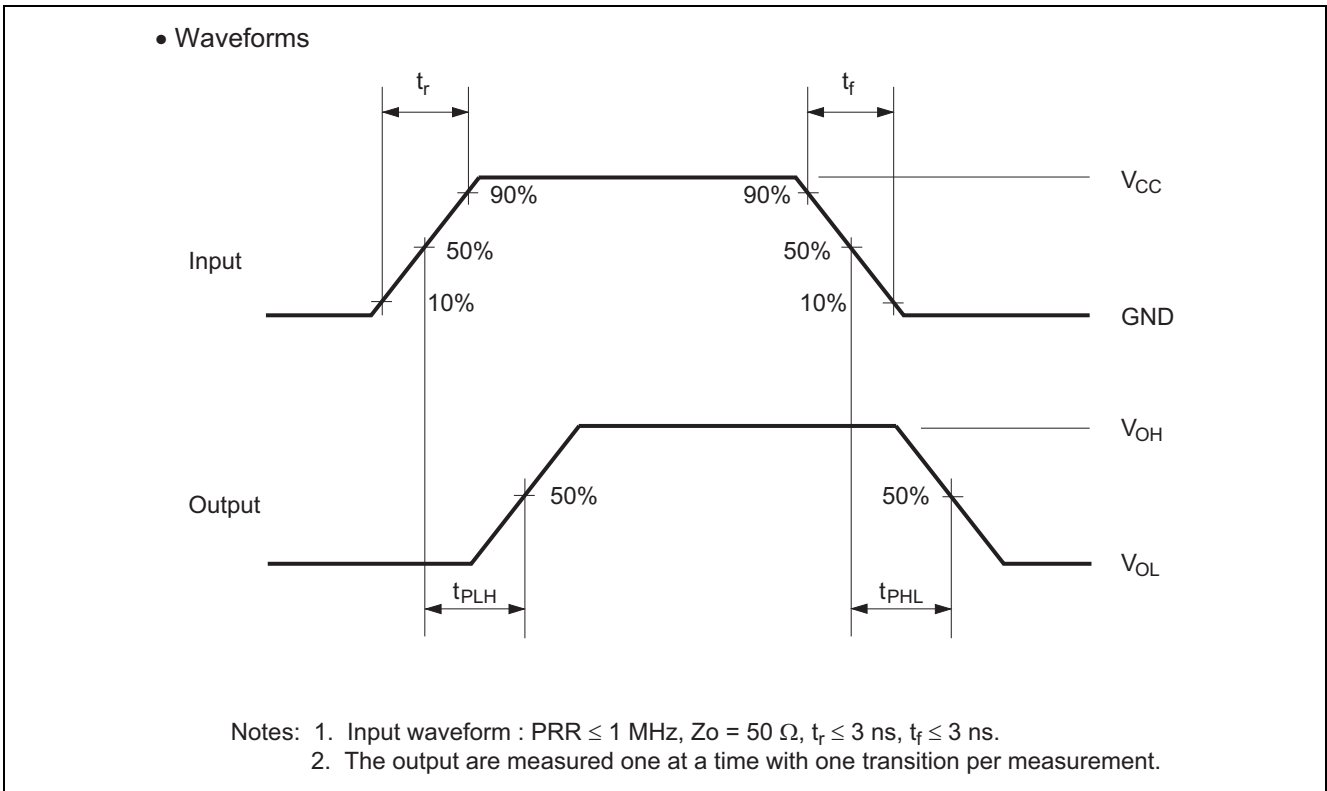
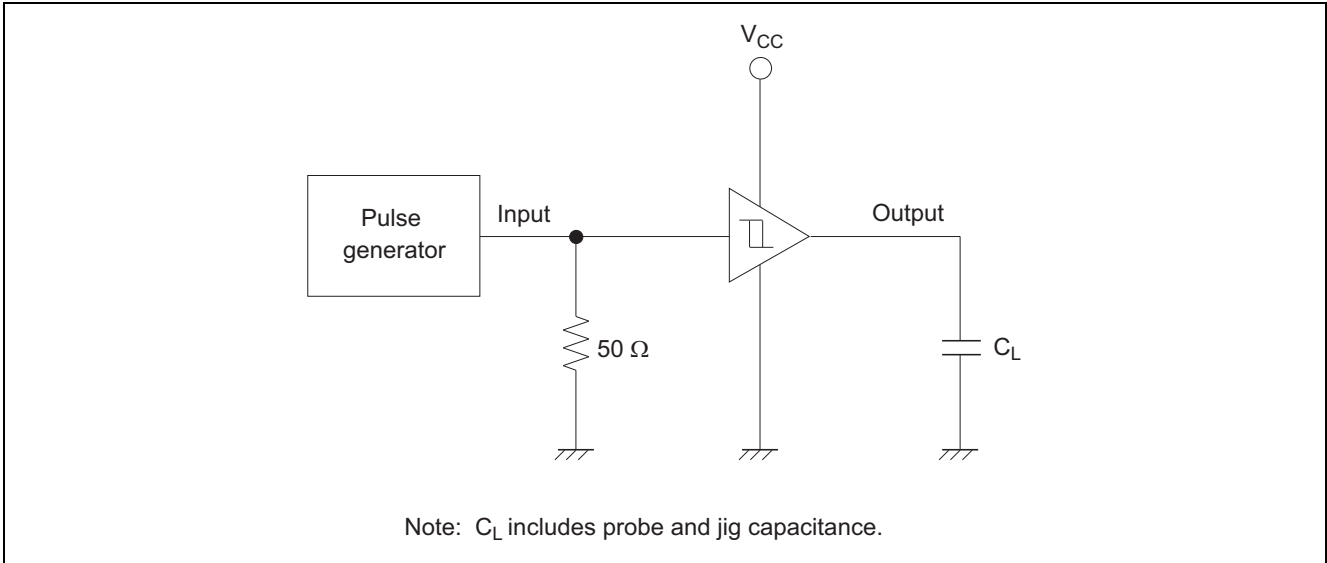

Package Dimensions

JEITA Package Code	RENESAS Code	Previous Code	MASS (Typ) [g]
SC-88	PTSP0006JA-A	CMPAK-6 / CMPAK-6V	0.006

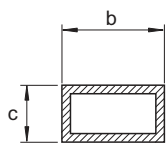
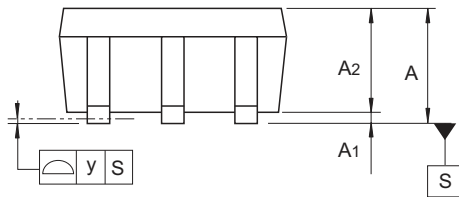
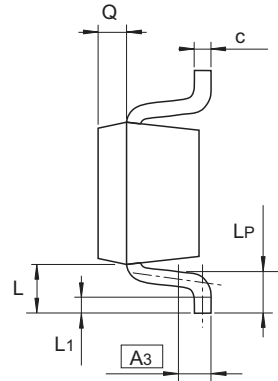
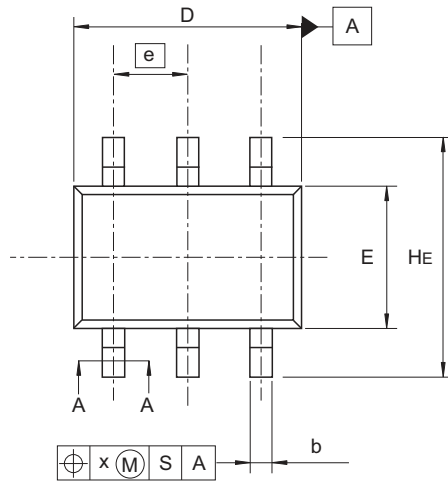

A-A Section

Reference Symbol	Dimensions in millimeters		
	Min	Nom	Max
A	0.8	—	1.1
A ₁	0	—	0.1
A ₂	0.8	0.9	1.0
A ₃	—	0.25	—
b	0.15	0.2	0.25
c	0.1	0.15	0.25
D	1.8	2.0	2.2
E	1.15	1.25	1.35
e	—	0.65	—
HE	2.0	2.1	2.2
L	0.3	—	0.7
L ₁	0.1	—	0.5
L _P	0.2	—	0.6
x	—	—	0.05
y	—	—	0.05
Q	—	0.25	—

© 2013 Renesas Electronics Corporation. All rights reserved.

Notice

1. Descriptions of circuits, software and other related information in this document are provided only to illustrate the operation of semiconductor products and application examples. You are fully responsible for the incorporation of these circuits, software, and information in the design of your equipment. Renesas Electronics assumes no responsibility for any losses incurred by you or third parties arising from the use of these circuits, software, or information.
2. Renesas Electronics has used reasonable care in preparing the information included in this document, but Renesas Electronics does not warrant that such information is error free. Renesas Electronics assumes no liability whatsoever for any damages incurred by you resulting from errors in or omissions from the information included herein.
3. Renesas Electronics does not assume any liability for infringement of patents, copyrights, or other intellectual property rights of third parties by or arising from the use of Renesas Electronics products or technical information described in this document. No license, express, implied or otherwise, is granted hereby under any patents, copyrights or other intellectual property rights of Renesas Electronics or others.
4. You should not alter, modify, copy, or otherwise misappropriate any Renesas Electronics product, whether in whole or in part. Renesas Electronics assumes no responsibility for any losses incurred by you or third parties arising from such alteration, modification, copy or otherwise misappropriation of Renesas Electronics product.
5. Renesas Electronics products are classified according to the following two quality grades: "Standard" and "High Quality". The recommended applications for each Renesas Electronics product depends on the product's quality grade, as indicated below.
"Standard": Computers; office equipment; communications equipment; test and measurement equipment; audio and visual equipment; home electronic appliances; machine tools; personal electronic equipment; and industrial robots etc.
"High Quality": Transportation equipment (automobiles, trains, ships, etc.); traffic control systems; anti-disaster systems; anti-crime systems; and safety equipment etc.
Renesas Electronics products are neither intended nor authorized for use in products or systems that may pose a direct threat to human life or bodily injury (artificial life support devices or systems, surgical implantations etc.), or may cause serious property damages (nuclear reactor control systems, military equipment etc.). You must check the quality grade of each Renesas Electronics product before using it in a particular application. You may not use any Renesas Electronics product for any application for which it is not intended. Renesas Electronics shall not be in any way liable for any damages or losses incurred by you or third parties arising from the use of any Renesas Electronics product for which the product is not intended by Renesas Electronics.
6. You should use the Renesas Electronics products described in this document within the range specified by Renesas Electronics, especially with respect to the maximum rating, operating supply voltage range, movement power voltage range, heat radiation characteristics, installation and other product characteristics. Renesas Electronics shall have no liability for malfunctions or damages arising out of the use of Renesas Electronics products beyond such specified ranges.
7. Although Renesas Electronics endeavors to improve the quality and reliability of its products, semiconductor products have specific characteristics such as the occurrence of failure at a certain rate and malfunctions under certain use conditions. Further, Renesas Electronics products are not subject to radiation resistance design. Please be sure to implement safety measures to guard them against the possibility of physical injury, and injury or damage caused by fire in the event of the failure of a Renesas Electronics product, such as safety design for hardware and software including but not limited to redundancy, fire control and malfunction prevention, appropriate treatment for aging degradation or any other appropriate measures. Because the evaluation of microcomputer software alone is very difficult, please evaluate the safety of the final products or systems manufactured by you.
8. Please contact a Renesas Electronics sales office for details as to environmental matters such as the environmental compatibility of each Renesas Electronics product. Please use Renesas Electronics products in compliance with all applicable laws and regulations that regulate the inclusion or use of controlled substances, including without limitation, the EU RoHS Directive. Renesas Electronics assumes no liability for damages or losses occurring as a result of your noncompliance with applicable laws and regulations.
9. Renesas Electronics products and technology may not be used for or incorporated into any products or systems whose manufacture, use, or sale is prohibited under any applicable domestic or foreign laws or regulations. You should not use Renesas Electronics products or technology described in this document for any purpose relating to military applications or use by the military, including but not limited to the development of weapons of mass destruction. When exporting the Renesas Electronics products or technology described in this document, you should comply with the applicable export control laws and regulations and follow the procedures required by such laws and regulations.
10. It is the responsibility of the buyer or distributor of Renesas Electronics products, who distributes, disposes of, or otherwise places the product with a third party, to notify such third party in advance of the contents and conditions set forth in this document, Renesas Electronics assumes no responsibility for any losses incurred by you or third parties as a result of unauthorized use of Renesas Electronics products.
11. This document may not be reproduced or duplicated in any form, in whole or in part, without prior written consent of Renesas Electronics.
12. Please contact a Renesas Electronics sales office if you have any questions regarding the information contained in this document or Renesas Electronics products, or if you have any other inquiries.
(Note 1) "Renesas Electronics" as used in this document means Renesas Electronics Corporation and also includes its majority-owned subsidiaries.
(Note 2) "Renesas Electronics product(s)" means any product developed or manufactured by or for Renesas Electronics.



SALES OFFICES

Renesas Electronics Corporation

<http://www.renesas.com>

Refer to "<http://www.renesas.com/>" for the latest and detailed information.

Renesas Electronics America Inc.
2880 Scott Boulevard Santa Clara, CA 95050-2554, U.S.A.
Tel: +1-408-586-6000, Fax: +1-408-588-6130

Renesas Electronics Canada Limited
1101 Nicholson Road, Newmarket, Ontario L3Y 9C3, Canada
Tel: +1-905-898-5441, Fax: +1-905-898-3220

Renesas Electronics Europe Limited
Dukes Meadow, Millboard Road, Bourne End, Buckinghamshire, SL8 5FH, U.K.
Tel: +44-1628-651-700, Fax: +44-1628-651-804

Renesas Electronics Europe GmbH
Arcadiastrasse 10, 40472 Düsseldorf, Germany
Tel: +49-211-65030, Fax: +49-211-6503-1327

Renesas Electronics (China) Co., Ltd.
7th Floor, Quantum Plaza, No.27 ZhiChunLu Haidian District, Beijing 100083, P.R.China
Tel: +86-10-8235-1155, Fax: +86-10-8235-7679

Renesas Electronics (Shanghai) Co., Ltd.
Unit 301, Tower A, Central Towers, 555 LanGao Rd., Putuo District, Shanghai, China
Tel: +86-21-2226-0888, Fax: +86-21-2226-0999

Renesas Electronics Hong Kong Limited
Unit 1601-1613, 16/F., Tower 2, Grand Century Place, 193 Prince Edward Road West, Mongkok, Kowloon, Hong Kong
Tel: +852-2886-9318, Fax: +852 2886-9022/9044

Renesas Electronics Taiwan Co., Ltd.
13F, No. 363, Fu Shing North Road, Taipei, Taiwan
Tel: +886-2-8175-9600, Fax: +886 2-8175-9670

Renesas Electronics Singapore Pte. Ltd.
80 Bendemeer Road, Unit #06-02 Hyflux Innovation Centre Singapore 339949
Tel: +65-6213-0200, Fax: +65-6213-0300

Renesas Electronics Malaysia Sdn.Bhd.
Unit 906, Block B, Menara Amcorp, Amcorp Trade Centre, No. 18, Jln Persiaran Barat, 46050 Petaling Jaya, Selangor Darul Ehsan, Malaysia
Tel: +60-3-7955-9390, Fax: +60-3-7955-9510

Renesas Electronics Korea Co., Ltd.
12F., 234 Teheran-ro, Gangnam-Gu, Seoul, 135-080, Korea
Tel: +82-2-558-3737, Fax: +82-2-558-5141

X-ON Electronics

Largest Supplier of Electrical and Electronic Components

Click to view similar products for [Buffers & Line Drivers](#) category:

Click to view products by [Renesas](#) manufacturer:

Other Similar products are found below :

[5962-9217601MSA](#) [634810D](#) [CY2DP1502ZXI](#) [HEF4043BP](#) [NL17SG125DFT2G](#) [NL17SZ126P5T5G](#) [NLU1GT126CMUTCG](#)
[NLU3G16AMX1TCG](#) [NLV27WZ125USG](#) [CY2CP1504ZXC](#) [CY2DP1510AXC](#) [MC74HCT365ADTR2G](#) [BCM6306KMLG](#)
[54FCT240CTDB](#) [Le87401NQC](#) [Le87402MQC](#) [028192B](#) [042140C](#) [051117G](#) [070519XB](#) [065312DB](#) [091056E](#) [098456D](#) [NL17SG07DFT2G](#)
[NL17SG17DFT2G](#) [NL17SG34DFT2G](#) [NL17SZ07P5T5G](#) [NL17SZ125P5T5G](#) [NLU1GT126AMUTCG](#) [NLV27WZ16DFT2G](#)
[NLV74LCX244DTR2G](#) [CY2DP1504ZXI](#) [5962-8982101PA](#) [5962-9052201PA](#) [74LVC07ADR2G](#) [MC74VHC1G125DFT1G](#)
[NL17SH17P5T5G](#) [NL17SZ125CMUTCG](#) [NLV17SZ07DFT2G](#) [NLV37WZ17USG](#) [NLVHCT244ADTR2G](#) [74HCT126T14-13](#)
[NL17SH125P5T5G](#) [NLV14049UBDTR2G](#) [NLV37WZ07USG](#) [74VHC541FT\(BE\)](#) [SNJ54LVTH244AW](#) [RHFAC244K1](#) [74LVC1G17FW4-7](#)
[74LVC1G126FZ4-7](#)