

ISL71010B25

Ultra Low Noise, 2.5V Precision Voltage Reference

FN8960
Rev.1.00
Apr 12, 2018

The [ISL71010B25](#) is an ultra low noise, high DC accuracy precision voltage reference with a wide input voltage range from 4V to 30V. The ISL71010B25 uses the dielectrically isolated PR40 process to achieve $1.9\mu\text{V}_{\text{P-P}}$ noise at 0.1Hz to 10Hz with an initial voltage accuracy of $\pm 0.05\%$.

The ISL71010B25 offers a 2.5V output voltage with $10\text{ppm}/^\circ\text{C}$ temperature coefficient and also provides excellent line and load regulation. The device is offered in an 8 Ld SOIC package.

The ISL71010B25 is ideal for high-end instrumentation, data acquisition, and processing applications requiring high DC precision where low noise performance is critical.

Applications

- Low Earth Orbit (LEO)
- High altitude avionics
- Precision instruments
- Data acquisition systems for space applications
- Strain and pressure gauges for space applications
- Active sources for sensors

Features

- Reference output voltage: $2.5\text{V} \pm 0.05\%$
- Accuracy over temperature/radiation: $\pm 0.15\%$
- Output voltage noise: $1.9\mu\text{V}_{\text{P-P}}$ typical (0.1Hz to 10Hz)
- Supply current: $930\mu\text{A}$ (typical)
- Temperature coefficient: $10\text{ppm}/^\circ\text{C}$ (max)
- Output current capability: 20mA
- Line regulation: $18\text{ppm}/\text{V}$ (max)
- Load regulation: $17\text{ppm}/\text{mA}$ (max)
- NiPdAu-Ag lead finish (Sn free)
- Dielectrically isolated PR40 process
- Operating temperature range: -55°C to $+125^\circ\text{C}$
- Passes NASA Low Outgassing Specifications
- Characterized radiation level:
 - Low dose rate (10mrad(Si): 30krad(Si)
 - Single event burnout LET: $43\text{MeV}\cdot\text{cm}^2/\text{mg}$

Related Literature

For a full list of related documents, visit our website

- [ISL7101B25](#) product page

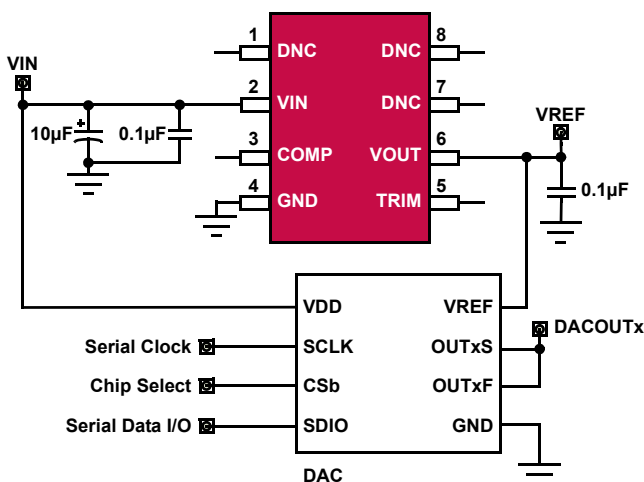

Figure 1. ISL71010B25 Typical Application Diagram

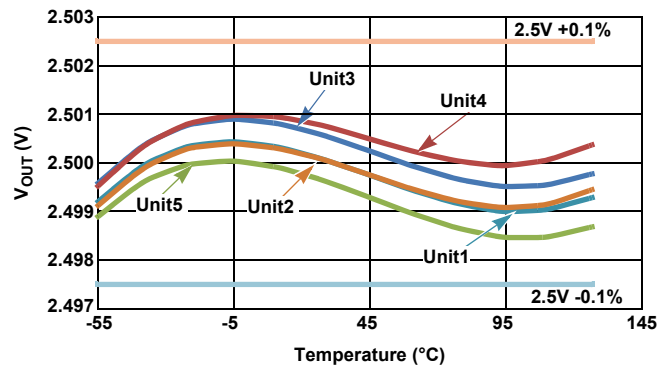

Figure 2. V_{OUT} vs Temperature

1. Overview

1.1 Functional Block Diagram

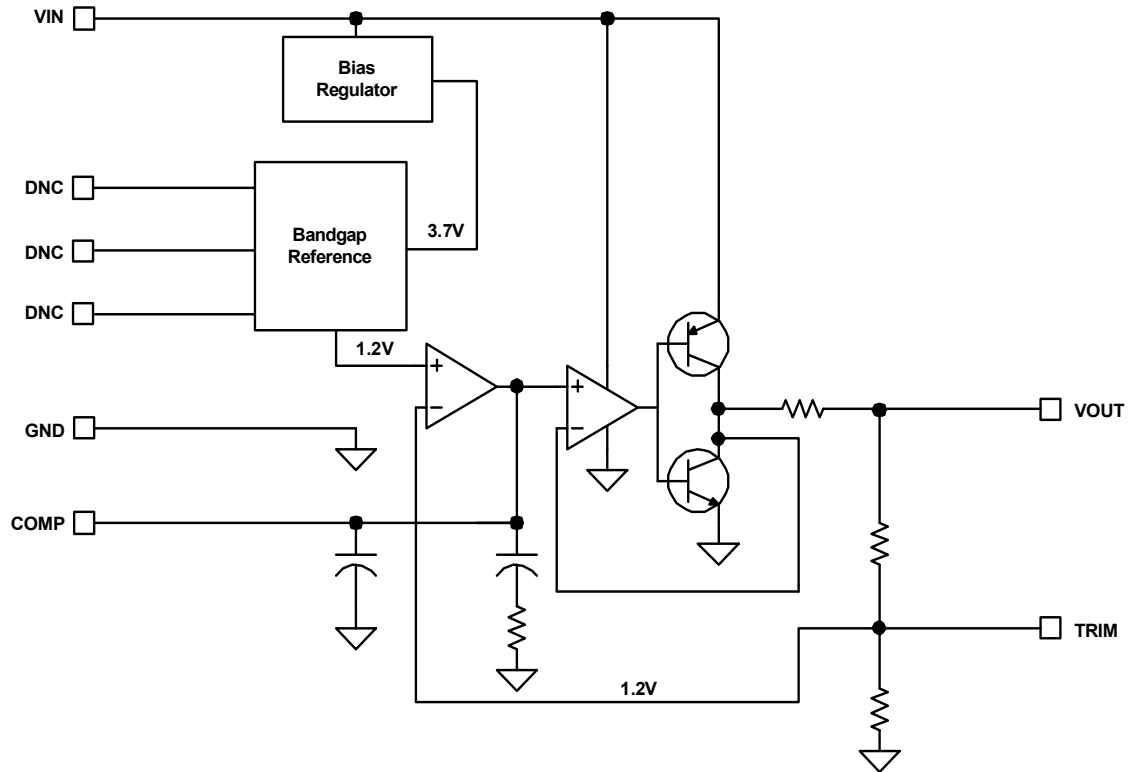

Figure 3. Functional Block Diagram

1.2 Ordering Information

Part Number (Notes 2, 3)	Part Marking	V _{OUT} Option (V)	Accuracy (%)	Tempco (ppm/°C)	Temp Range (°C)	Tape and Reel (Units)	Package (RoHS Compliant)	Pkg. Dwg. #
ISL71010BMB25Z	71010 BMZ25	2.50	±0.05	10	-55 to +125	-	8 Ld SOIC	M8.15
ISL71010BMB25Z-TK (Note 1)	71010 BMZ25	2.50	±0.05	10	-55 to +125	1k	8 Ld SOIC	M8.15
ISL71010BM25EV1Z	Evaluation Board							

Notes:

1. Refer to [TB347](#) for details about reel specifications.
2. These Pb-free plastic packaged products employ special Pb-free material sets, molding compounds/die attach materials and NiPdAu-Ag plate -e4 termination finish, which is RoHS compliant and compatible with both SnPb and Pb-free soldering operations. Pb-free products are MSL classified at Pb-free peak reflow temperatures that meet or exceed the Pb-free requirements of IPC/JEDEC J STD-020.
3. For Moisture Sensitivity Level (MSL), see the [ISL71010B25](#) product information page. For more information about MSL refer to [TB363](#).

1.3 Pin Configuration

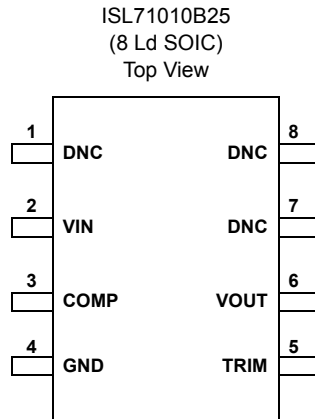

1.4 Pin Description

Pin Number	Pin Name	ESD Circuit	Description
1, 7, 8	DNC	3	Do not connect. Internally terminated.
2	VIN	1	Input voltage connection
3	COMP	2	Compensation and noise reduction capacitor
4	GND	1	Ground connection.
5	TRIM	2	Voltage reference trim input
6	VOUT	2	Voltage reference output

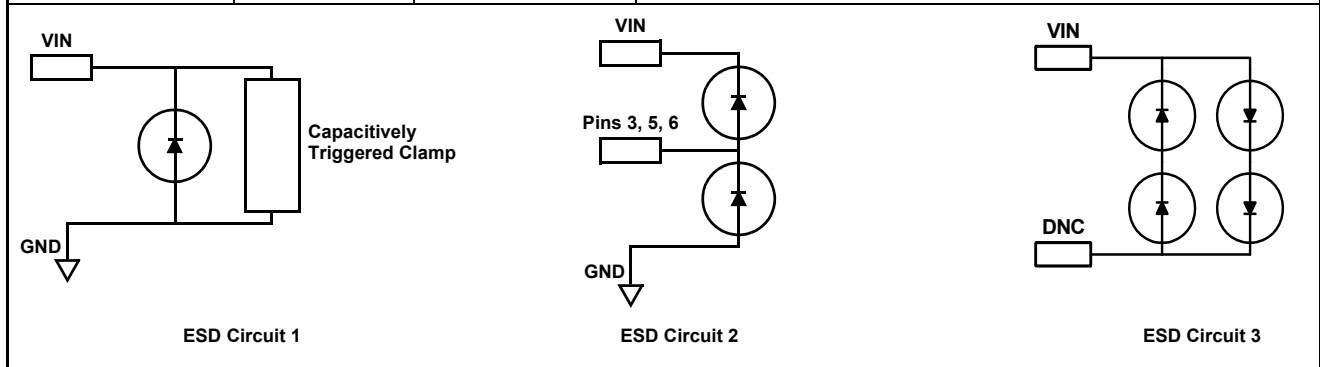

2. Specifications

2.1 Absolute Maximum Ratings

Parameter	Minimum	Maximum	Unit
Max Voltage			
V_{IN} to GND	-0.5	+40	V
V_{OUT} to GND (10s)	-0.5	$V_{OUT} + 0.5$	V
Voltage on any Pin to Ground	-0.5	$V_{OUT} + 0.5$	V
Voltage on DNC pins	No connections permitted to these pins		
Input Voltage Slew Rate (Max)		0.1	V/ μ s
ESD Rating	Value		Unit
Human Body Model (Tested per JS-001-2014)	3		kV
Machine Model (Tested per JESD22-A115-C)	200		V
Charged Device Model (Tested per JS-002-2014)	2		kV
Latch-Up (Tested per JESD-78E; Class 2, Level A) at +125°C	± 100		mA

CAUTION: Do not operate at or near the maximum ratings listed for extended periods of time. Exposure to such conditions may adversely impact product reliability and result in failures not covered by warranty.

2.2 Outgas Testing

Specification (Tested per ASTM E 595, 1.5)	Value	Unit
Total Mass Lost (Note 4)	0.06	%
Collected Volatile Condensable Material (Note 4)	<0.01	%
Water Vapor Recovered	0.03	%

Notes:

- Results meet NASA low outgassing requirements of "Total Mass Lost" of <1% and "Collected Volatile Condensable Material" of <0.1%.

2.3 Thermal Information

Thermal Resistance (Typical)	θ_{JA} (°C/W)	θ_{JC} (°C/W)
8 Ld SOIC Package (Notes 5, 6)	110	60

Notes:

- θ_{JA} is measured with the component mounted on a high-effective thermal conductivity test board in free air. See [TB379](#).
- For θ_{JC} , the "case temp" location is taken at the package top center.

Parameter	Minimum	Maximum	Unit
Continuous Power Dissipation ($T_A = +125^\circ\text{C}$)		217	mW
Maximum Junction Temperature (T_{JMAX})		+150	°C
Storage Temperature Range	-65	+150	°C
Pb-Free Reflow Profile	Refer to TB493		

2.4 Recommended Operating Conditions

Parameter	Minimum	Maximum	Unit
V_{IN}	4.0	+30	V
Temperature Range	-55	+125	°C

2.5 Electrical Specifications

$V_{IN} = 5V$, $I_{OUT} = 0mA$, $C_{OUT} = 0.1\mu F$, $COMP = 1nF$ unless otherwise specified. **Boldface limits apply over the operating temperature range, -55°C to +125°C.**

Description	Parameter	Test Conditions	Min (Note 8)	Typ	Max (Note 8)	Unit
Output Voltage	V_{OUT}	$V_{IN} = 5V$		2.5		V
V_{OUT} Accuracy at $T_A = +25^\circ C$	V_{OA}	$V_{OUT} = 2.5V$ (Note 7)	-0.05		+0.05	%
V_{OUT} Accuracy at $T_A = -55^\circ C$ to $+125^\circ C$		$V_{OUT} = 2.5V$ (Note 7)	-0.15		+0.15	%
Output Voltage Temperature Coefficient (Note 9)	$TC V_{OUT}$				10	ppm/°C
Input Voltage Range	V_{IN}	$V_{OUT} = 2.5V$	4		30	V
Supply Current	I_{IN}			0.92	1.28	mA
Line Regulation	$\Delta V_{OUT} / \Delta V_{IN}$	$V_{IN} = 4V$ to $30V$, $V_{OUT} = 2.5V$		6	18	ppm/V
Load Regulation	$\Delta V_{OUT} / \Delta I_{OUT}$	Sourcing: $0mA \leq I_{OUT} \leq 20mA$		2.5	17	ppm/mA
		Sinking: $-10mA \leq I_{OUT} \leq 0mA$		2.5	17	ppm/mA
Dropout Voltage (Note 10)	V_D	$V_{OUT} = 2.5V$ at $10mA$		1.1	1.7	V
Short-Circuit Current	I_{SC+}	$T_A = +25^\circ C$, V_{OUT} tied to GND		54	75	mA
Short-Circuit Current	I_{SC-}	$T_A = +25^\circ C$, V_{OUT} tied to V_{IN}	-100	-60		mA
Turn-on Settling Time	t_R	90% of final value, $C_L = 1.0\mu F$, $C_C = open$		150		μs
Ripple Rejection		$f = 120Hz$		90		dB
Noise Voltage	e_{np-p}	$0.1Hz \leq f \leq 10Hz$, $V_{OUT} = 2.5V$		1.9		μV_{P-P}
Broadband Voltage Noise	V_n	$10Hz \leq f \leq 1kHz$, $V_{OUT} = 2.5V$		1.6		μV_{RMS}
Noise Voltage Density	e_n	$f = 1kHz$, $V_{OUT} = 2.5V$		50		nV/ \sqrt{Hz}
Long Term Stability	$\Delta V_{OUT} / \Delta t$	$T_A = +25^\circ C$		20		ppm

Notes:

- Post-reflow drift for the ISL71010B25 devices can exceed 100 μV to 1.0mV based on experimental results with devices on FR4 double sided boards. The system engineer must take this into account when considering the reference voltage after assembly.
- Compliance to datasheet limits is assured by one or more methods: production test, characterization, and/or design.
- Over the specified temperature range. Temperature coefficient is measured by the box method whereby the change in V_{OUT} is divided by the temperature range; in this case, $-55^\circ C$ to $+125^\circ C = +180^\circ C$. See "[Specifying Temperature Coefficient \(Box Method\)](#)" on page 11 for more information.
- Dropout Voltage is the minimum $V_{IN} - V_{OUT}$ differential voltage measured at the point where V_{OUT} drops 1mV from $V_{IN} = nominal$ at $T_A = +25^\circ C$.

3. Typical Performance Curves

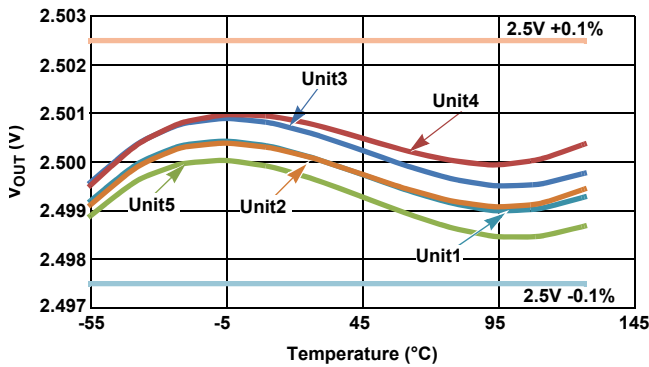

Figure 4. V_{OUT} vs Temperature, Five Units

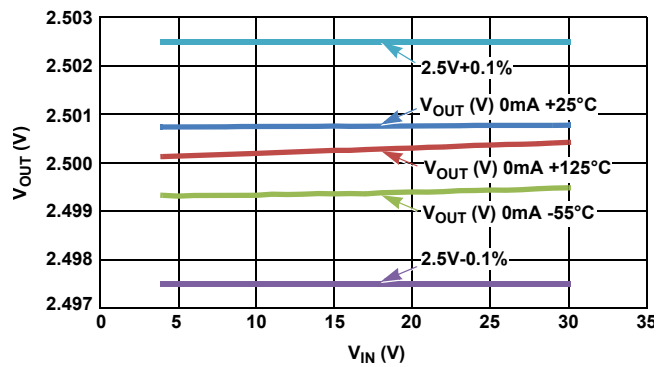

Figure 5. V_{OUT} Accuracy Over-Temperature

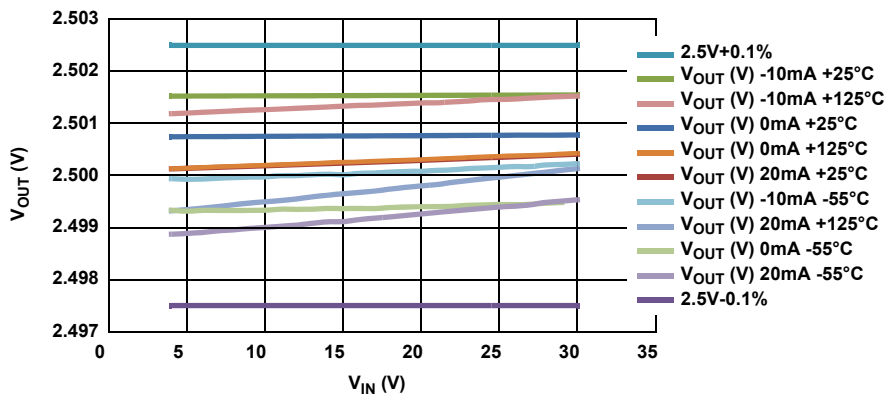

Figure 6. V_{OUT} vs V_{IN} at 0mA, 20mA, and -10mA

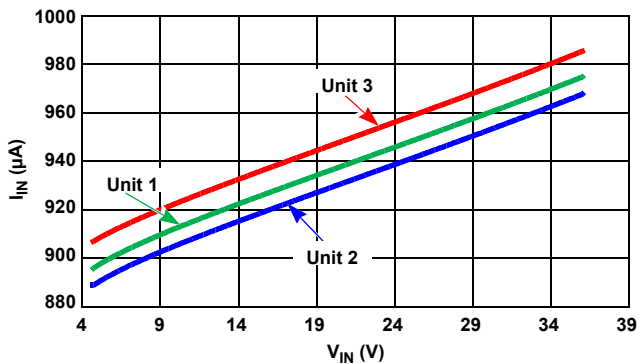

Figure 7. I_{IN} vs V_{IN} , Three Units

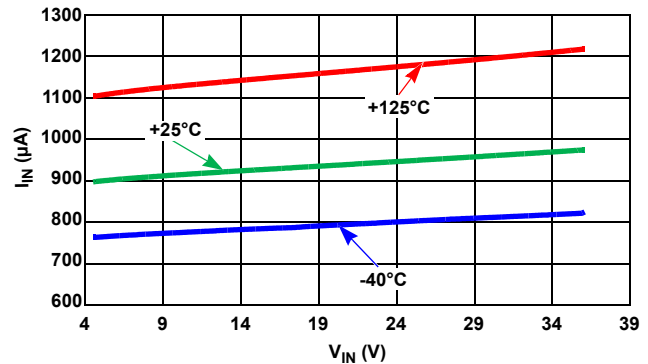

Figure 8. I_{IN} vs V_{IN} , Three Temperatures

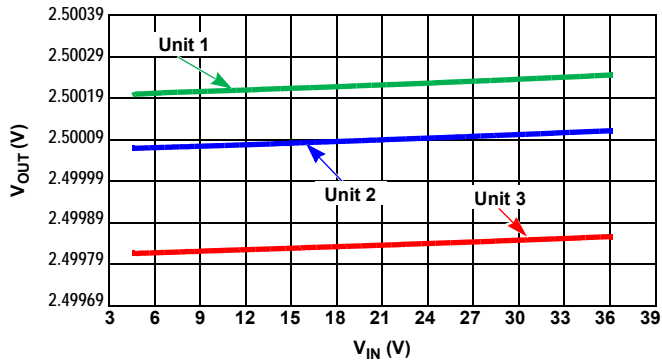

Figure 9. Line Regulation, Three Units

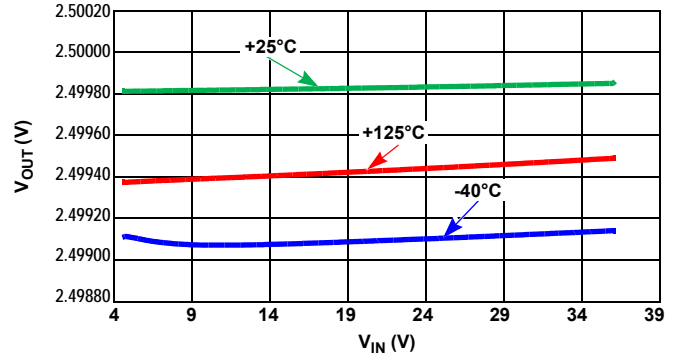

Figure 10. Line Regulation, Three Temperatures

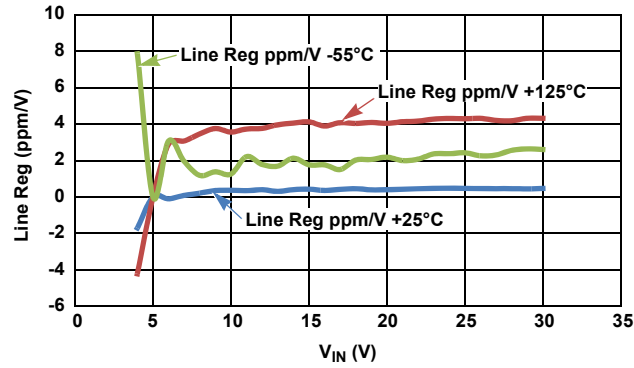

Figure 11. Line Regulation Over-Temperature (0mA)

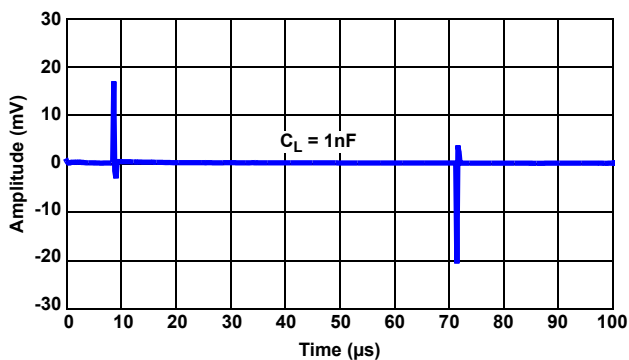

Figure 12. Line Transient with 1nF Load ($\Delta V_{in} = \pm 500mV$)

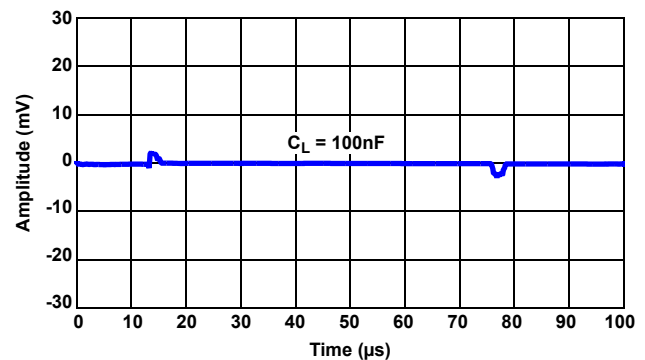

Figure 13. Line Transient with 100nF Load ($\Delta V_{in} = \pm 500mV$)

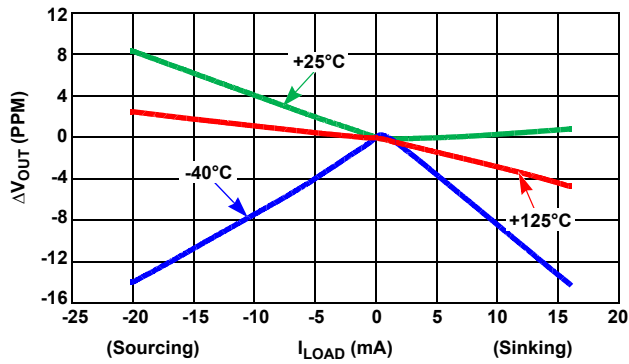

Figure 14. Load Regulation, Three Temperatures

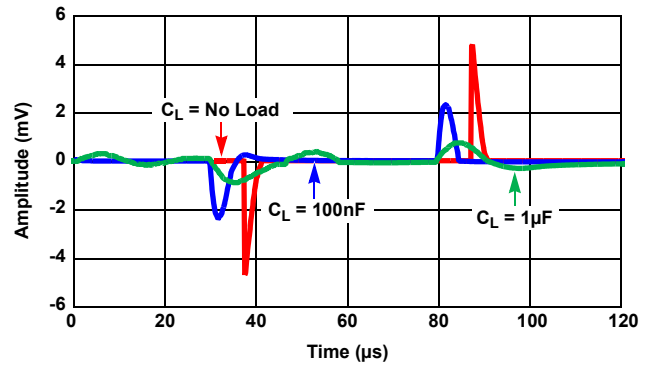

Figure 15. Load Transient ($\Delta I_{LOAD} = \pm 1\text{mA}$)

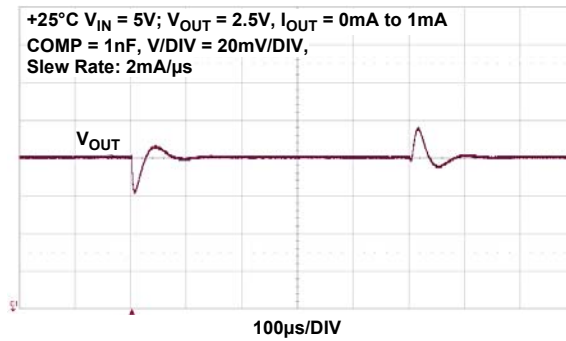

Figure 16. Load Transient (0mA to 1mA)

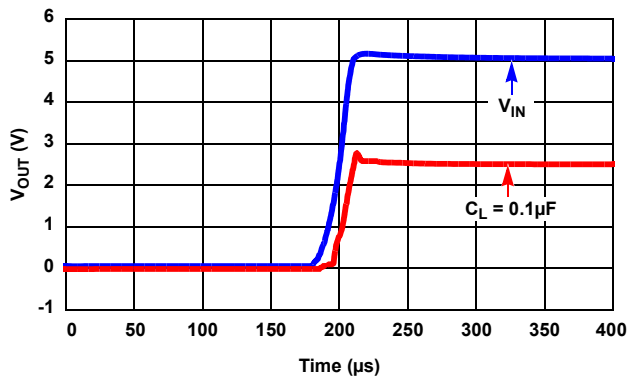

Figure 17. Turn-On Time with 0.1μF

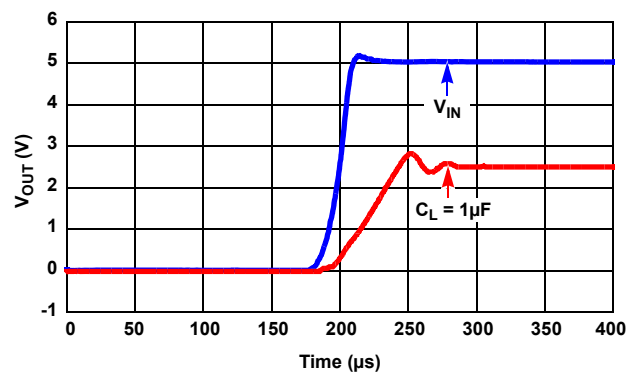

Figure 18. Turn-On Time with 1μF

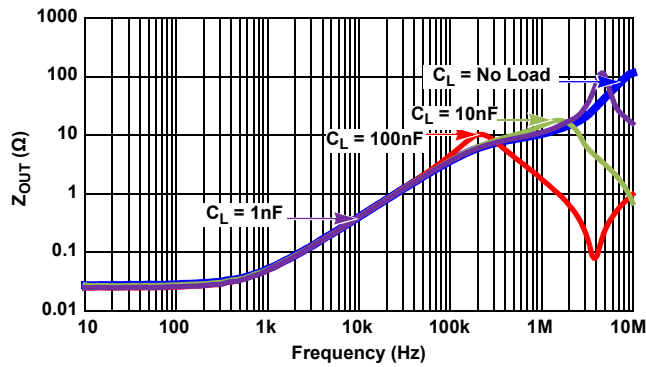

Figure 19. Z_{OUT} vs Frequency

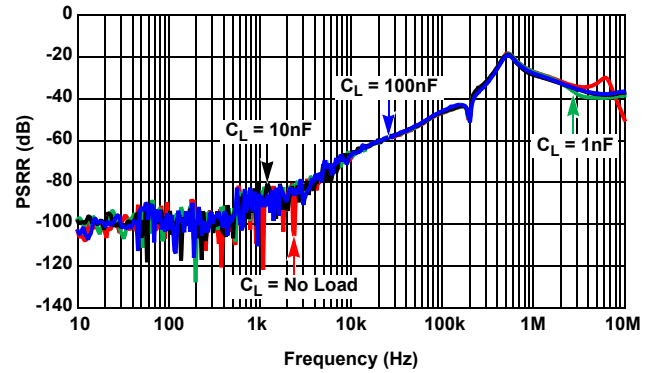

Figure 20. PSRR at Different Capacitive Loads

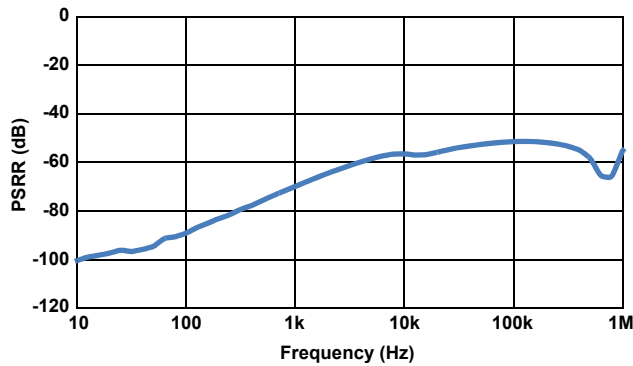

Figure 21. PSRR (+25°C, $V_{IN} = 5V$, $V_{OUT} = 2.5V$, $I_{OUT} = 0mA$, $C_{IN} = C_{OUT} = 0.1\mu F$, $COMP = 1nF$, $VSIG = 300mV_{P-P}$)

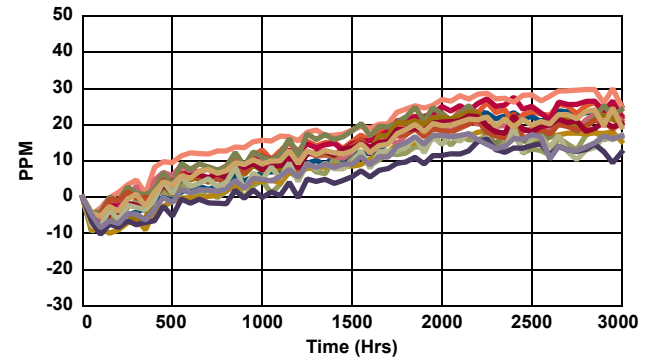

Figure 22. Long Term Stability

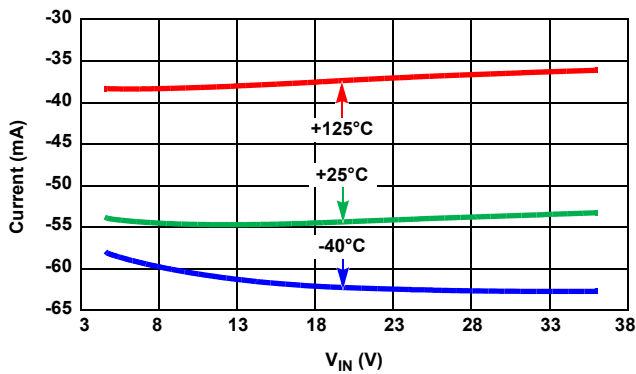

Figure 23. Short-Circuit to GND

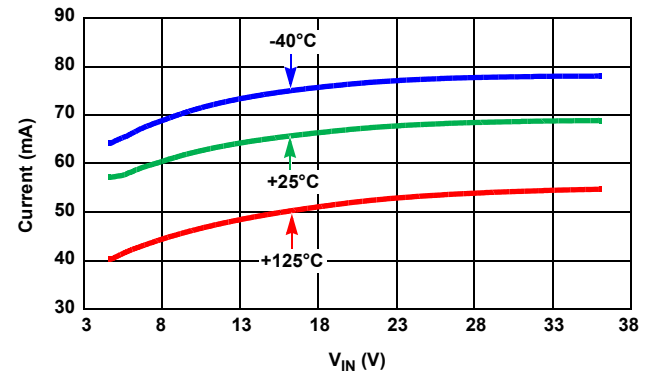

Figure 24. Short-Circuit to V_{IN}

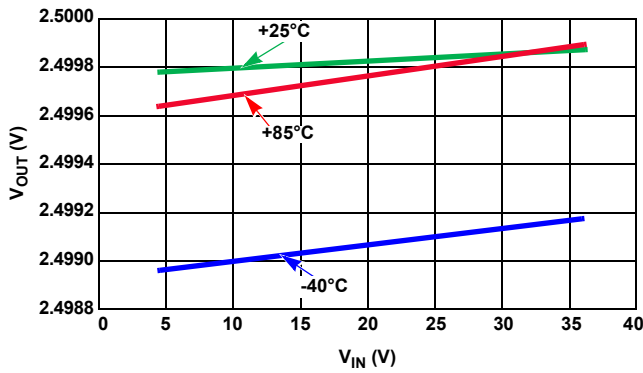

Figure 25. Dropout with -10mA Load

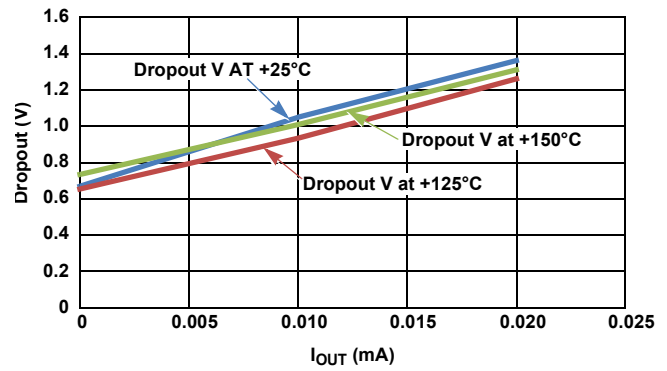

Figure 26. Dropout Voltage for 2.5V

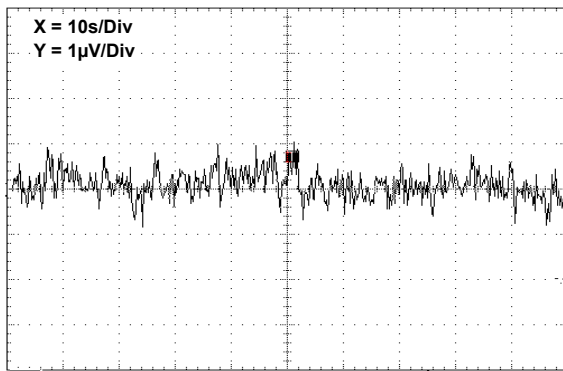

Figure 27. V_{OUT} vs Noise, 0.1Hz to 10Hz

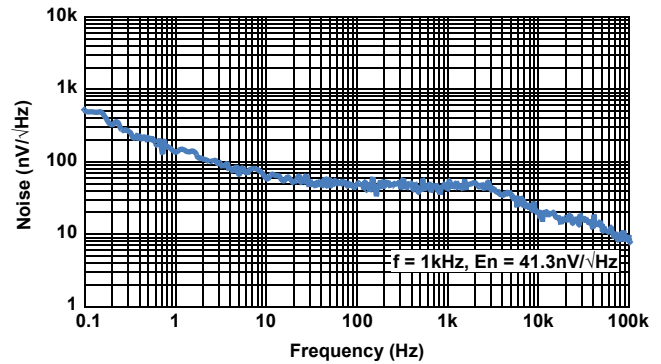

Figure 28. Noise Density vs Frequency ($V_{IN} = 5.0V$, $I_{OUT} = 0mA$, $C_{IN} = 0.1\mu F$, $C_{OUT} = 1\mu F$, $COMP = 1nF$)

4. Applications Information

4.1 Bandgap Precision Reference

The ISL71010B25 uses a bandgap architecture and special trimming circuitry to produce a temperature compensated, precision voltage reference with high input voltage capability and moderate output current drive. Low noise performance is achieved using optimized biasing techniques. Key features for precision low noise portable applications, such as handheld meters and instruments, are supply current (930 μ A) and noise (1.9 μ V_{P-P}, 0.1Hz to 10Hz bandwidth). Data converters in particular can use the ISL71010B25 as an external voltage reference. Low power DAC and ADC circuits will realize maximum resolution with the lowest noise. The device maintains output voltage during conversion cycles with fast response, although it is helpful to add an output capacitor, typically 1 μ F.

4.2 Board Mounting Considerations

For applications requiring the highest accuracy, the board mounting location should be considered. The device uses a plastic SOIC package, which subjects the die to mild stresses when the Printed Circuit Board (PCB) is heated and cooled, which slightly changes the shape. Because of these die stresses, placing the device in areas subject to slight twisting can degrade the reference voltage accuracy. It is normally best to place the device near the edge of a board, or on the shortest side, because the axis of bending is most limited in that location. Mounting the device in a cutout also minimizes flex. Obviously, mounting the device on flexprint or extremely thin PC material will likewise cause loss of reference accuracy.

4.3 Board Assembly Considerations

Some PCB assembly precautions are necessary. Normal output voltage shifts of 100 μ V can be expected with Pb-free reflow profiles or wave solder on multi-layer FR4 PCBs. Precautions should be taken to avoid excessive heat or extended exposure to high reflow or wave solder temperatures.

4.4 Noise Performance and Reduction

The output noise voltage in a 0.1Hz to 10Hz bandwidth is typically 1.9 μ V_{P-P} ($V_{OUT} = 2.5V$). The noise measurement is made with a bandpass filter. The filter is made of a 1-pole high-pass filter, with a corner frequency at 0.1Hz, and a 2-pole low-pass filter, with a corner frequency (3dB) at 9.9Hz, to create a filter with a 9.9Hz bandwidth. Noise in the 10Hz to 1kHz bandwidth is approximately 1.6 μ V_{RMS} ($V_{OUT} = 2.5V$), with 0.1 μ F capacitance on the output. This noise measurement is made with a 2 decade bandpass filter. The filter is made of a 1-pole high-pass filter with a corner frequency at 10Hz of the center frequency, and 1-pole low-pass filter with a corner frequency at 1kHz. Load capacitance up to 10 μ F can be added, but will result in only marginal improvements in output noise and transient response.

4.5 Turn-On Time

Normal turn-on time is typically 150 μ s. The circuit designer must take this into account when looking at power-up delays or sequencing.

4.6 Specifying Temperature Coefficient (Box Method)

The limits stated for temperature coefficient (Tempco) are governed by the method of measurement. The overwhelming standard for specifying the temperature drift of a reference is to measure the reference voltage at two temperatures, which provide for the maximum voltage deviation. Divide the total variation, ($V_{HIGH} - V_{LOW}$) by the temperature extremes of measurement ($T_{HIGH} - T_{LOW}$). The result is divided by the nominal reference voltage (at $T = +25^{\circ}C$) and multiplied by 10^6 to yield ppm/ $^{\circ}C$. This is the "Box" method for specifying temperature coefficient.

4.7 Output Voltage Adjustment

The output voltage can be adjusted above and below the factory-calibrated value using the trim terminal. The trim terminal is the negative feedback divider point of the output operational amplifier. The voltage at the TRIM pin is set at approximately 1.216V by the internal bandgap and amplifier circuitry of the voltage reference.

The suggested method to adjust the output is to connect a 1M Ω external resistor directly to the trim terminal and connect the other end to the wiper of a potentiometer that has a 100k Ω resistance and with outer terminals that connect to V_{OUT} and ground. If a 1M Ω resistor is connected to trim, the output adjust range will be ± 6.3 mV. The TRIM pin should not have any capacitor tied to its output. It is important to minimize the capacitance on the trim terminal during layout to preserve output amplifier stability. It is also best to connect the series resistor directly to the trim terminal, to minimize that capacitance and also to minimize noise injection. Small trim adjustments will not disturb the factory-set temperature coefficient of the reference, but trimming near the extreme values can.

4.8 Output Stage

The output stage of the device has a push-pull configuration with a high-side PNP and a low-side NPN. This helps the device to act as a source and sink. The device can source 20mA and sink 10mA.

4.9 Use of COMP Capacitors

The reference can be compensated for the C_{OUT} capacitors used by adding a capacitor from the COMP pin to GND. See [Table 1](#) for recommended values of the COMP capacitor.

Table 1. COMP Capacitor Recommended Values

C _{OUT} (μ F)	C _{COMP} (nF)
0.1	1
1	1
10	10

5. Radiation Tolerance

The ISL71010B25 is a radiation tolerant device for commercial space applications, Low Earth Orbit (LEO) applications, high altitude avionics, launch vehicles, and other harsh environments. This device's response to Total Ionizing Dose (TID) radiation effects and Single-Event Effects (SEE) has been measured, characterized, and reported in the following sections. However, TID performance is not guaranteed through radiation acceptance testing, nor is the SEE characterized performance guaranteed.

5.1 Total Ionizing Dose (TID) Testing

5.1.1 Introduction

This test was conducted to determine the sensitivity of the part to the total dose environment. Down points were 0krad(Si), 10krad(Si), 20krad(Si), and 30krad(Si). The irradiations were followed by a biased anneal for 168 hours at +100°C.

Total dose testing was performed using a Hopewell Designs N40 panoramic ⁶⁰Co irradiator. The irradiations were performed at 0.00875rad(Si)/s. A PbAl box was used to shield the test fixture and devices under test against low energy secondary gamma radiation.

The characterization matrix consisted of 23 samples irradiated under bias and 12 samples irradiated with all pins grounded. Two control units were used to ensure repeatable data. Two different wafers were used. The bias configuration is shown in [Figure 29](#).

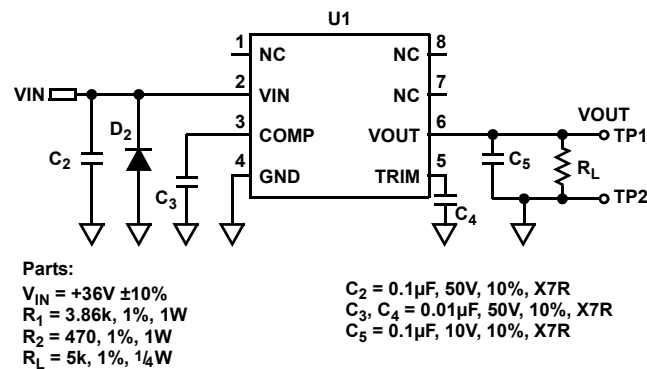

Figure 29. Irradiation Bias Configuration and Power Supply Sequencing for the ISL71010B25

All electrical testing was performed outside the irradiator using the production Automated Test Equipment (ATE), with data logging at each down point (including anneal). Downpoint electrical testing was performed at room temperature.

5.1.2 Results

Table 2 summarizes the attributes data. “Bin 1” indicates a device that passes all datasheet specification limits.

Table 2. ISL71010B25 Total Dose Test Attributes Data

Dose Rate (mrad(Si)/s)	Bias	Sample Size	Down Point	Bin 1	Rejects
8.75	Figure 29	23	Pre-rad	23	0
			10krad(Si)	23	0
			20krad(Si)	23	0
			30krad(Si)	23	0
		11	Anneal	11	0
8.75	Grounded	12	Pre-rad	12	0
			10krad(Si)	12	0
			20krad(Si)	12	0
			30krad(Si)	12	0
			Anneal	12	0

The plots in Figures 30 through 35 show data for key parameters at all down points. The plots show the average as a function of total dose for each of the irradiation conditions; we chose to use the average because of the relatively large sample sizes. All parts showed excellent stability over irradiation.

Table 3 on page 16 shows the average of the key parameters with respect to total dose in tabular form.

5.2 Data Plots

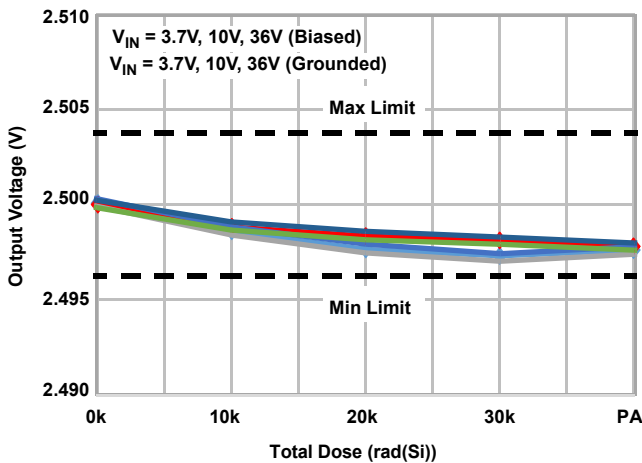

Figure 30. V_{REF} Output Voltage vs TID

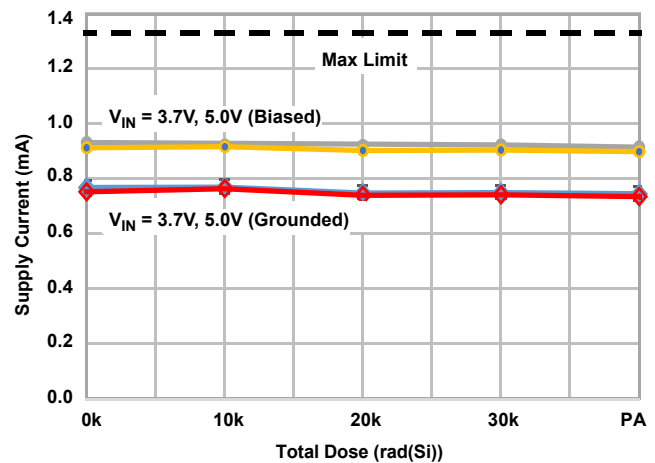

Figure 31. Supply Current vs TID

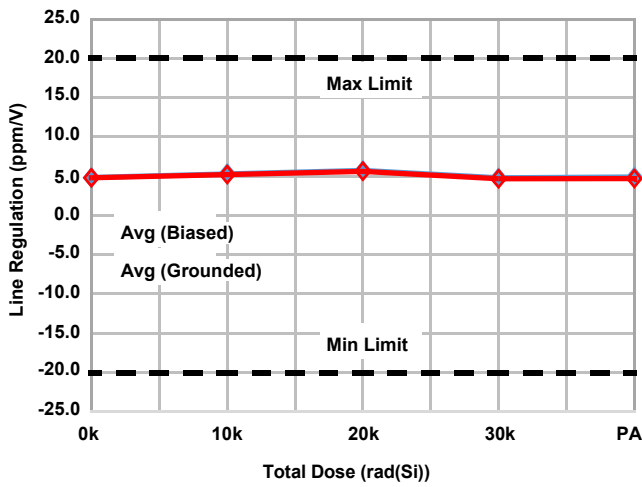

Figure 32. Line Regulation vs TID

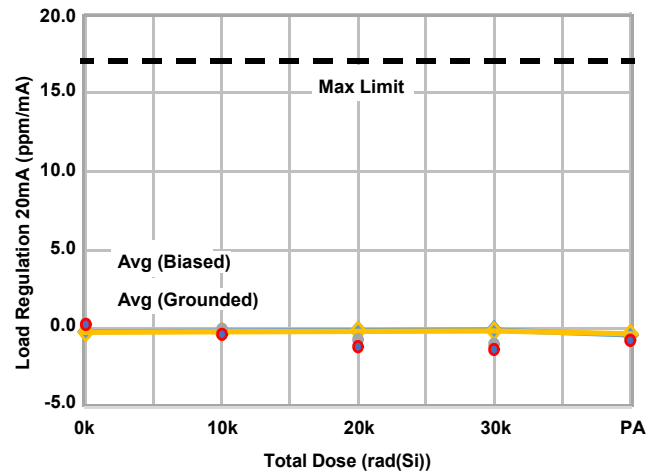

Figure 33. Load Regulation 20mA Sourcing vs TID

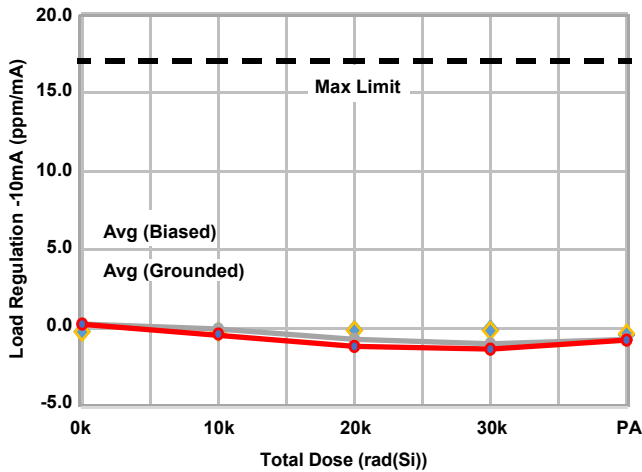

Figure 34. Load Regulation -10mA Sinking vs TID

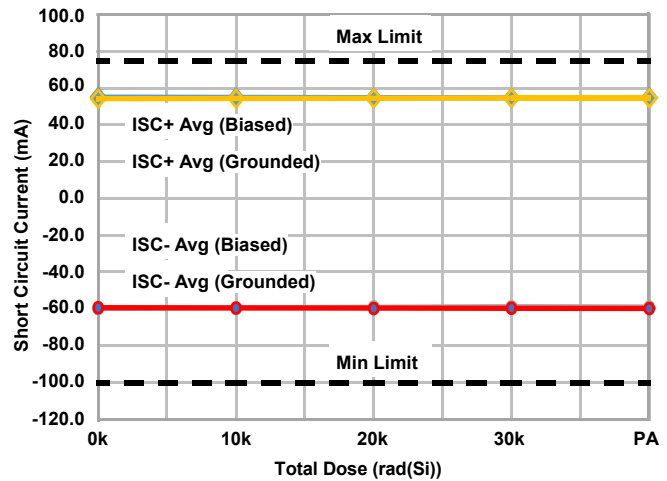

Figure 35. Short-Circuit Current vs TID

5.2.1 Conclusion

ATE characterization testing showed no rejects to the datasheet limits at all down points. Variables data for selected parameters is presented in [Figures 30](#) through [35](#). No differences between biased and unbiased irradiation were noted, and the part is not considered bias sensitive.

Table 3. ISL71010B25 Response of Key Parameters vs TID

Parameter	Symbol	Condition	Bias	0krad(Si)	10krad(Si)	20krad(Si)	30krad(Si)	Anneal	Unit
Output Voltage	V_{OUT}	$V_{IN} = 10V$	Biased	2.500080	2.498605	2.497645	2.497313	2.497611	V
			Grounded	2.500000	2.498824	2.498346	2.498124	2.497802	
		$V_{IN} = 3.7V$	Biased	2.499935	2.498409	2.497462	2.497026	2.497399	
			Grounded	2.499851	2.498677	2.498152	2.497917	2.497603	
		$V_{IN} = 36V$	Biased	2.500326	2.498840	2.497926	2.497422	2.497796	
			Grounded	2.500239	2.499098	2.498607	2.498295	2.497983	
Supply Current	I_{IN}	$V_{CC} = 3.7V$	Biased	0.76974	0.77023	0.74926	0.75103	0.74642	mA
			Grounded	0.75359	0.76480	0.74092	0.74276	0.73603	
		$V_{CC} = 5.0V$	Biased	0.93293	0.92385	0.92188	0.92347	0.91606	
			Grounded	0.91372	0.91735	0.90389	0.90546	0.89972	
Line Regulation	$\Delta V_{OUT} / \Delta V_{IN}$	$V_{IN} = 4V \text{ to } 30V,$ $V_{OUT} = 2.5V$	Biased	4.843	5.348	5.744	4.807	4.909	ppm/V
			Grounded	4.807	5.214	5.626	4.687	4.712	
Load Regulation	$\Delta V_{OUT} / \Delta I_{OUT}$	20mA Sourcing	Biased	-0.193	-0.219	-0.108	-0.079	-0.388	ppm/mA
			Grounded	-0.221	-0.200	-0.128	-0.135	-0.314	
		-10mA Sinking	Biased	0.296	-0.026	-0.684	-0.978	-0.681	
			Grounded	0.285	-0.350	-1.133	-1.315	-0.736	
Short-Circuit Current	I_{SC+}	$V_{OUT} = GND$	Biased	55.141	54.819	54.668	54.693	54.805	mA
			Grounded	54.246	54.329	54.520	54.541	54.617	
	I_{SC-}	$V_{OUT} = V_{IN}$	Biased	-59.807	-59.662	-59.012	-58.797	-58.995	
			Grounded	-59.332	-59.485	-59.814	-59.613	-59.724	

5.3 Single-Event Effects Testing

5.3.1 Introduction

The intense heavy ion environment encountered in space applications can cause a variety of Single-Event Effects (SEE). SEE can lead to system-level performance issues including disruption, degradation, and destruction. For predictable and reliable space system operation, individual electronic components should be characterized to determine their SEE response. The following is a summary of the ISL71010B25 SEE testing.

5.3.2 SEE Test Setup

Testing was performed at the Texas A&M University (TAMU) Cyclotron Institute heavy ion facility.

A schematic of the ISL71010B25 SEE test circuit is shown in [Figure 42 on page 19](#). The test circuit is configured to accept an input voltage from 4V to 30V and generate the 2.5V nominal output voltage. The output current of the reference was adjusted using fixed load resistors on test board. The output capacitor, C_4 , and the compensation capacitor C_2 were 0.1 μ F and 1nF, respectively.

Digital multimeters were used to monitor input voltage (V_{IN}), output voltage (V_{OUT}), and input current (I_{IN}). A LeCroy Waverunner digital oscilloscope was used to monitor, capture and store key signal waveforms. The scope was configured to trigger with V_{OUT} signal levels of $\pm 20mV$.

5.3.3 SEB Testing Results

For the SEB tests, conditions were selected to maximize the electrical and thermal stresses on the Device Under Test (DUT), thus insuring worst-case conditions. The input voltage (V_{IN}) was initially set to 35V and then increased in 1V increments. The output current (I_{OUT}) was set to 20mA which is the maximum recommended current rating for load regulation of the device. Case temperature was maintained at +125°C by controlling the current flowing into a resistive heater bonded to the underside of the DUT. Four DUTs were irradiated with Ag ions at a normal incident angle, resulting in an effective LET of 43MeV•cm²/mg.

The failure criterion for destructive SEE was an increase in operating input current (I_{IN}) greater than 5% measured at 20mA output current. I_{IN} is defined as the total current drawn by the device. Failed devices were not further irradiated.

Four parts passed irradiation to 1×10^7 ions/cm² with 43MeV•cm²/mg at 39V and +125°C case temperature.

5.3.4 Single-Event Transient Testing

SET testing was done on four samples of the ISL71010B25, which were irradiated at room temperature across a range of LET from 2.7MeV•cm²/mg to 28MeV•cm²/mg to observe SET performance. Samples were separately tested to V_{IN} of 4V and 30V. The parts were configured with a 0.1μF output capacitor, a 1nF compensation capacitor, and a 20mA load current to set up the worst conditions for negative going transients. [Table 4](#) shows the SET summary giving the cross section for each input voltage and LET level.

[Figures 36](#) through [41](#) represent output waveform responses of the DUTs at the respective bias conditions and LET levels. The plots are composites of all the transients captured on the scope.

The worst case SET appeared for the case of LET = 28 and V_{IN} = 30V with about 235mV in negative SET and a recovery time of about 20μs.

Table 4. SET Summary of the Fully Functional ISL71010B25

Supply Voltage (V)	Ion/Angle	Eff LET (MeV•cm ² /mg)	Fluence per Run (Particles/cm ²)	Number of Runs	Total SET	Events CS (cm ²)
4	Ne/0	2.7	2.00E+06	4	40	5.00E-06
30	Ne/0	2.7	2.00E+06	4	6	7.50E-07
4	Ar/0	8.5	2.00E+06	4	256	3.20E-05
30	Ar/0	8.5	2.00E+06	4	365	4.56E-05
4	Kr/0	28	2.00E+06	4	439	5.49E-05
30	Kr/0	28	2.00E+06	4	754	9.43E-05

Note: Samples at 4.0V and 30V input voltage, C_{OUT} = 0.1μF, C_{COMP} = 1nF and I_{OUT} = 20mA. Trigger level for the output voltage set to ±20mV.

5.3.5 Data Plots

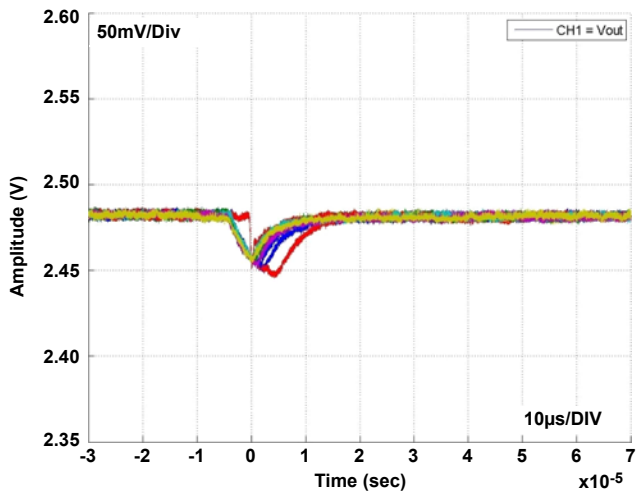

Figure 36. Composite SET Plot for ISL71010B25 at LET 2.7
 $V_{IN} = 4V$, $I_{OUT} = 20mA$, $C_{OUT} = 0.1\mu F$, $C_{COMP} = 1nF$

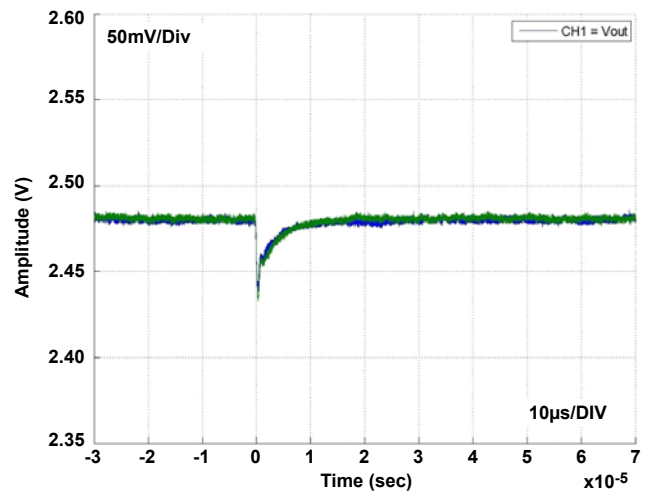

Figure 37. Composite SET Plot for ISL71010B25 at LET 2.7
 $V_{IN} = 30V$, $I_{OUT} = 20mA$, $C_{OUT} = 0.1\mu F$, $C_{COMP} = 1nF$

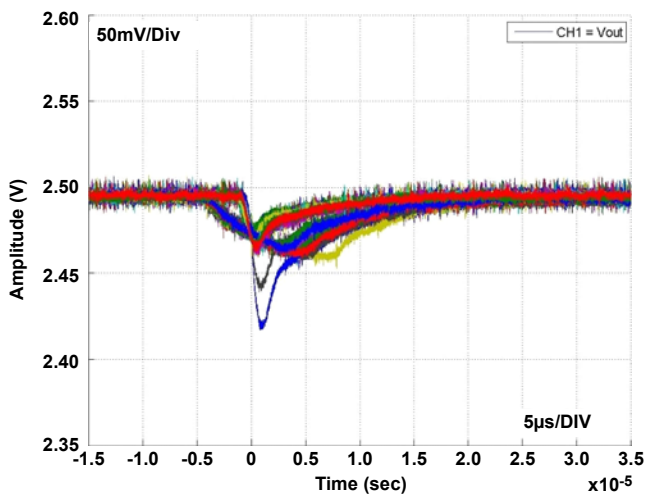

Figure 38. Composite SET Plot for ISL71010B25 at LET 8.5
 $V_{IN} = 4V$, $I_{OUT} = 20mA$, $C_{OUT} = 0.1\mu F$, $C_{COMP} = 1nF$

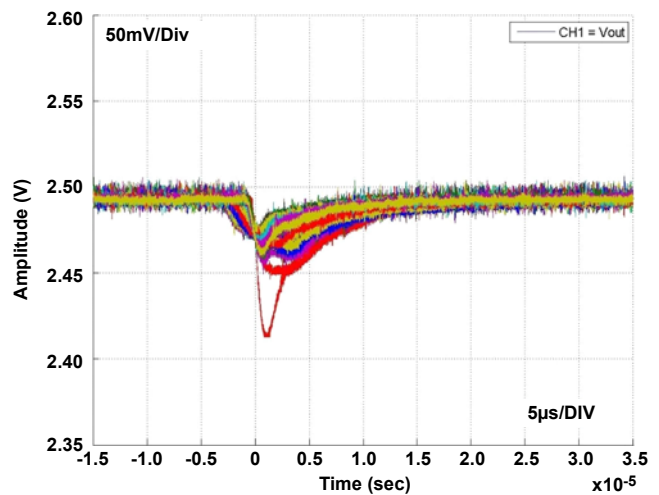

Figure 39. Composite SET Plot for ISL71010B25 at LET 8.5
 $V_{IN} = 30V$, $I_{OUT} = 20mA$, $C_{OUT} = 0.1\mu F$, $C_{COMP} = 1nF$

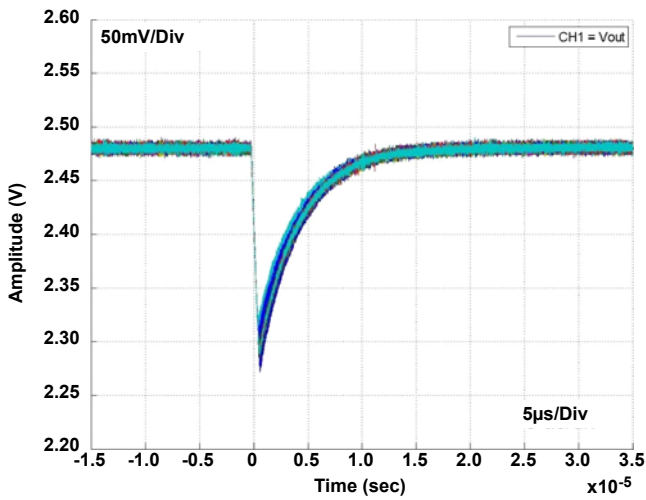

Figure 40. Composite SET Plot for ISL71010B25 at LET 28
 $V_{IN} = 4V, I_{OUT} = 20mA, C_{OUT} = 0.1\mu F, C_{COMP} = 1nF$

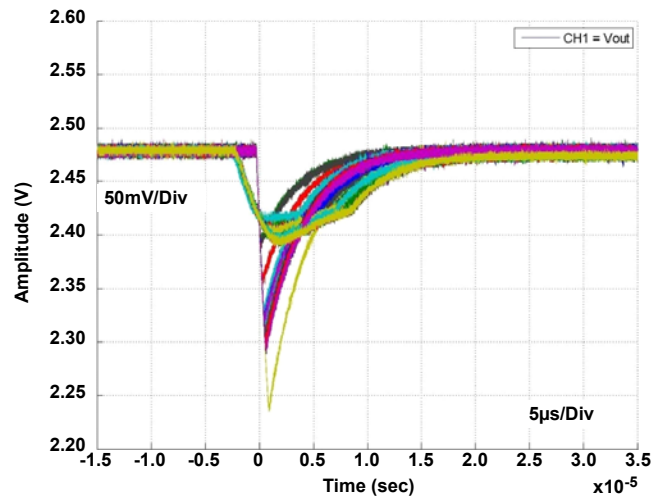

Figure 41. Composite SET Plot for ISL71010B25 at LET 28
 $V_{IN} = 30V, I_{OUT} = 20mA, C_{OUT} = 0.1\mu F, C_{COMP} = 1nF$

5.3.6 Conclusion

SEE testing has demonstrated that the ISL71010B25 is not susceptible to Single Event Burnout (SEB) at an LET of $43MeV \cdot cm^2/mg$ with an input voltage of 39V and a load current of 20mA. This represents conditions that are over 30% above the recommended input voltage of 30V and 100% of the load regulation drive capability of the IC (20mA).

SET testing demonstrated that all transients are negative and the higher the LET level, the greater the magnitude of the negative transient. At $LET = 28MeV \cdot cm^2/mg$ and $V_{IN} = 30V$ with $C_{OUT} = 0.10\mu F$, showed a 235mV negative transient during an SET event. The longest recovery times were about 20 μs .

A larger C_{OUT} capacitance value will suppress the SET magnitude but the SET disturbance duration will stretch out. Capacitor selection represents a compromise between SET magnitude and recovery duration.

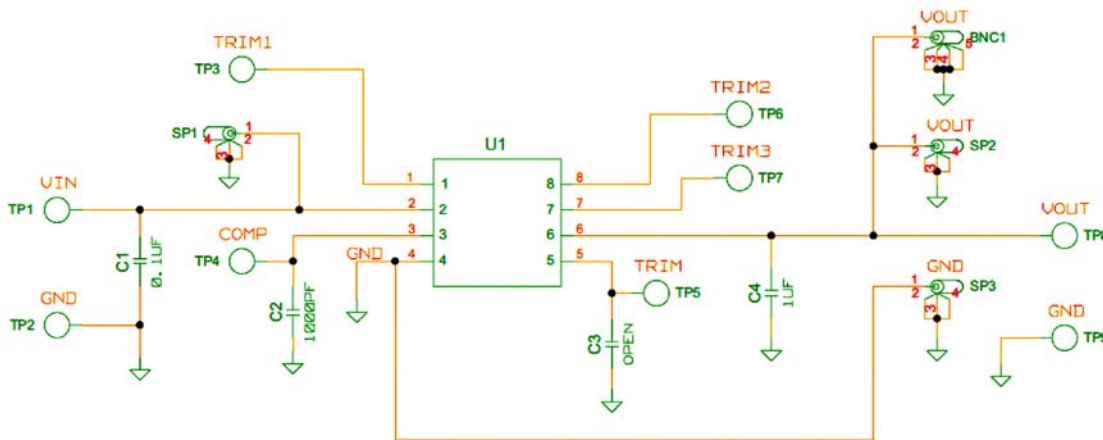

Figure 42. SEE Testing Schematic for the ISL71010B25

6. Revision History

Rev.	Date	Description
1.00	Apr 12, 2018	Added Outgassing Feature bullet. Updated Ordering information by adding -TK part to table and updated Note 1. Added Outgassing specification information. Removed About Intersil and updated disclaimer.
0.00	Sep 26, 2017	Initial release

7. Package Outline Drawing

For the most recent package outline drawing, see [M8.15](#).

M8.15
 8 LEAD NARROW BODY SMALL OUTLINE PLASTIC PACKAGE
 Rev 4, 1/12

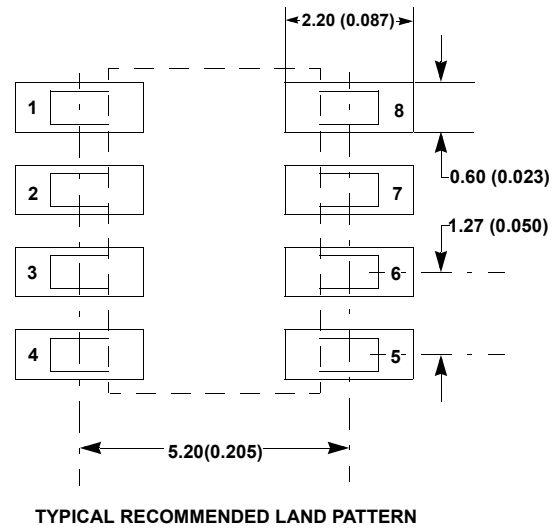
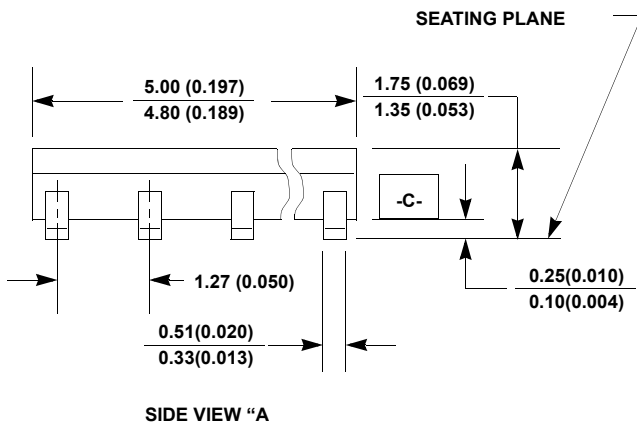
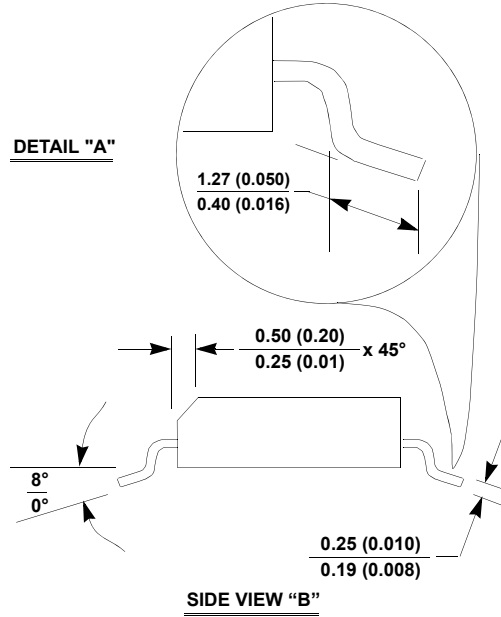
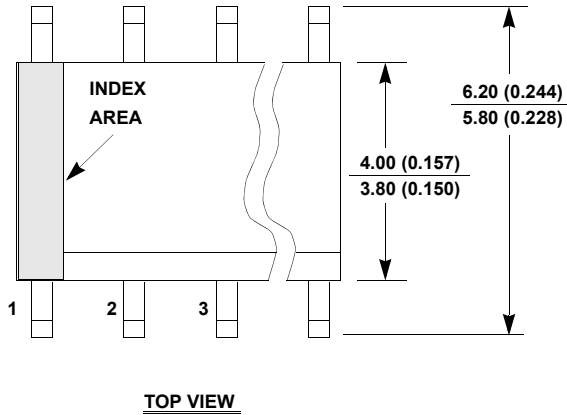

NOTES:

1. Dimensioning and tolerancing per ANSI Y14.5M-1994.
2. Package length does not include mold flash, protrusions or gate burrs. Mold flash, protrusion and gate burrs shall not exceed 0.15mm (0.006 inch) per side.
3. Package width does not include interlead flash or protrusions. Interlead flash and protrusions shall not exceed 0.25mm (0.010 inch) per side.
4. The chamfer on the body is optional. If it is not present, a visual index feature must be located within the crosshatched area.
5. Terminal numbers are shown for reference only.
6. The lead width as measured 0.36mm (0.014 inch) or greater above the seating plane, shall not exceed a maximum value of 0.61mm (0.024 inch).
7. Controlling dimension: MILLIMETER. Converted inch dimensions are not necessarily exact.
8. This outline conforms to JEDEC publication MS-012-AA ISSUE C.

Notice

1. Descriptions of circuits, software and other related information in this document are provided only to illustrate the operation of semiconductor products and application examples. You are fully responsible for the incorporation or any other use of the circuits, software, and information in the design of your product or system. Renesas Electronics disclaims any and all liability for any losses and damages incurred by you or third parties arising from the use of these circuits, software, or information.
2. Renesas Electronics hereby expressly disclaims any warranties against and liability for infringement or any other claims involving patents, copyrights, or other intellectual property rights of third parties, by or arising from the use of Renesas Electronics products or technical information described in this document, including but not limited to, the product data, drawings, charts, programs, algorithms, and application examples.
3. No license, express, implied or otherwise, is granted hereby under any patents, copyrights or other intellectual property rights of Renesas Electronics or others.
4. You shall not alter, modify, copy, or reverse engineer any Renesas Electronics product, whether in whole or in part. Renesas Electronics disclaims any and all liability for any losses or damages incurred by you or third parties arising from such alteration, modification, copying or reverse engineering.
5. Renesas Electronics products are classified according to the following two quality grades: "Standard" and "High Quality". The intended applications for each Renesas Electronics product depends on the product's quality grade, as indicated below.
"Standard": Computers; office equipment; communications equipment; test and measurement equipment; audio and visual equipment; home electronic appliances; machine tools; personal electronic equipment; industrial robots; etc.
"High Quality": Transportation equipment (automobiles, trains, ships, etc.); traffic control (traffic lights); large-scale communication equipment; key financial terminal systems; safety control equipment; etc.
Unless expressly designated as a high reliability product or a product for harsh environments in a Renesas Electronics data sheet or other Renesas Electronics document, Renesas Electronics products are not intended or authorized for use in products or systems that may pose a direct threat to human life or bodily injury (artificial life support devices or systems; surgical implantations; etc.), or may cause serious property damage (space system; undersea repeaters; nuclear power control systems; aircraft control systems; key plant systems; military equipment; etc.). Renesas Electronics disclaims any and all liability for any damages or losses incurred by you or any third parties arising from the use of any Renesas Electronics product that is inconsistent with any Renesas Electronics data sheet, user's manual or other Renesas Electronics document.
6. When using Renesas Electronics products, refer to the latest product information (data sheets, user's manuals, application notes, "General Notes for Handling and Using Semiconductor Devices" in the reliability handbook, etc.), and ensure that usage conditions are within the ranges specified by Renesas Electronics with respect to maximum ratings, operating power supply voltage range, heat dissipation characteristics, installation, etc. Renesas Electronics disclaims any and all liability for any malfunctions, failure or accident arising out of the use of Renesas Electronics products outside of such specified ranges.
7. Although Renesas Electronics endeavors to improve the quality and reliability of Renesas Electronics products, semiconductor products have specific characteristics, such as the occurrence of failure at a certain rate and malfunctions under certain use conditions. Unless designated as a high reliability product or a product for harsh environments in a Renesas Electronics data sheet or other Renesas Electronics document, Renesas Electronics products are not subject to radiation resistance design. You are responsible for implementing safety measures to guard against the possibility of bodily injury, injury or damage caused by fire, and/or danger to the public in the event of a failure or malfunction of Renesas Electronics products, such as safety design for hardware and software, including but not limited to redundancy, fire control and malfunction prevention, appropriate treatment for aging degradation or any other appropriate measures. Because the evaluation of microcomputer software alone is very difficult and impractical, you are responsible for evaluating the safety of the final products or systems manufactured by you.
8. Please contact a Renesas Electronics sales office for details as to environmental matters such as the environmental compatibility of each Renesas Electronics product. You are responsible for carefully and sufficiently investigating applicable laws and regulations that regulate the inclusion or use of controlled substances, including without limitation, the EU RoHS Directive, and using Renesas Electronics products in compliance with all these applicable laws and regulations. Renesas Electronics disclaims any and all liability for damages or losses occurring as a result of your noncompliance with applicable laws and regulations.
9. Renesas Electronics products and technologies shall not be used for or incorporated into any products or systems whose manufacture, use, or sale is prohibited under any applicable domestic or foreign laws or regulations. You shall comply with any applicable export control laws and regulations promulgated and administered by the governments of any countries asserting jurisdiction over the parties or transactions.
10. It is the responsibility of the buyer or distributor of Renesas Electronics products, or any other party who distributes, disposes of, or otherwise sells or transfers the product to a third party, to notify such third party in advance of the contents and conditions set forth in this document.
11. This document shall not be reprinted, reproduced or duplicated in any form, in whole or in part, without prior written consent of Renesas Electronics.
12. Please contact a Renesas Electronics sales office if you have any questions regarding the information contained in this document or Renesas Electronics products.
(Note 1) "Renesas Electronics" as used in this document means Renesas Electronics Corporation and also includes its directly or indirectly controlled subsidiaries.
(Note 2) "Renesas Electronics product(s)" means any product developed or manufactured by or for Renesas Electronics.

(Rev.4.0-1 November 2017)



SALES OFFICES

Renesas Electronics Corporation

<http://www.renesas.com>

Refer to "<http://www.renesas.com/>" for the latest and detailed information.

Renesas Electronics America Inc.
1001 Murphy Ranch Road, Milpitas, CA 95035, U.S.A.
Tel: +1-408-432-8888, Fax: +1-408-434-5351

Renesas Electronics Canada Limited
9251 Yonge Street, Suite 8309 Richmond Hill, Ontario Canada L4C 9T3
Tel: +1-905-237-2004

Renesas Electronics Europe Limited
Dukes Meadow, Millboard Road, Bourne End, Buckinghamshire, SL8 5FH, U.K.
Tel: +44-1628-651-700, Fax: +44-1628-651-804

Renesas Electronics Europe GmbH
Arcadiastrasse 10, 40472 Düsseldorf, Germany
Tel: +49-211-6503-0, Fax: +49-211-6503-1327

Renesas Electronics (China) Co., Ltd.
Room 1709 Quantum Plaza, No.27 ZhichunLu, Haidian District, Beijing, 100191 P. R. China
Tel: +86-10-8235-1155, Fax: +86-10-8235-7679

Renesas Electronics (Shanghai) Co., Ltd.
Unit 301, Tower A, Central Towers, 555 Langao Road, Putuo District, Shanghai, 200333 P. R. China
Tel: +86-21-2226-0888, Fax: +86-21-2226-0999

Renesas Electronics Hong Kong Limited
Unit 1601-1611, 16/F., Tower 2, Grand Century Place, 193 Prince Edward Road West, Mongkok, Kowloon, Hong Kong
Tel: +852-2265-6688, Fax: +852-2886-9022

Renesas Electronics Taiwan Co., Ltd.
13F, No. 363, Fu Shing North Road, Taipei 10543, Taiwan
Tel: +886-2-8175-9600, Fax: +886-2-8175-9670

Renesas Electronics Singapore Pte. Ltd.
80 Bendemeer Road, Unit #06-02 Hyflux Innovation Centre, Singapore 339949
Tel: +65-6213-0200, Fax: +65-6213-0300

Renesas Electronics Malaysia Sdn.Bhd.
Unit 1207, Block B, Menara Amcorp, Amcorp Trade Centre, No. 18, Jln Persiaran Barat, 46050 Petaling Jaya, Selangor Darul Ehsan, Malaysia
Tel: +60-3-7955-9390, Fax: +60-3-7955-9510

Renesas Electronics India Pvt. Ltd.
No.777C, 100 Feet Road, HAL 2nd Stage, Indiranagar, Bangalore 560 038, India
Tel: +91-80-67208700, Fax: +91-80-67208777

Renesas Electronics Korea Co., Ltd.
17F, KAMCO Yangjae Tower, 262, Gangnam-daero, Gangnam-gu, Seoul, 06265 Korea
Tel: +82-2-558-3737, Fax: +82-2-558-5338

X-ON Electronics

Largest Supplier of Electrical and Electronic Components

Click to view similar products for [Voltage References](#) category:

Click to view products by [Renesas](#) manufacturer:

Other Similar products are found below :

[622664A](#) [636116E](#) [748389C](#) [AS431ARTR-E1](#) [NCP431BCSNT1G](#) [NCP432BCSNT1G](#) [NCV431BSNT1G](#) [AP4313UKTR-G1](#)
[TL1431AIYDT](#) [AZ431BR-ATRE1](#) [622668D](#) [NCP432BVSNT1G](#) [5962-8686103XC](#) [NCV431BVDMR2G](#) [AP4306BUKTR-G1](#)
[SC431BVSNT1G](#) [MAX6023EBT30+T](#) [NCV431ASNT1G](#) [LM4040CEM3-5.0/V+T](#) [LT1460KCS3-3#TRM](#) [LT1460KCS3-3.3#TRM](#)
[LT1019AIS8-2.5](#) [LT6660KCDC-10#TRMPBF](#) [LTC6652BHLS8-5#PBF](#) [LTC6652AHLS8-4.096#PBF](#) [LTC6655BHLS8-4.096#PBF](#)
[LT6660HCDC-5#TRMPBF](#) [LM336Z-2.5#PBF](#) [LT1021BMH-10](#) [SC431ILPRAG](#) [TLVH431MIL3T](#) [MAX6023EBT21+T](#) [AP432AQG-7](#)
[ADR4540CRZ](#) [LM4040B25QFTA](#) [TS3325AQPR](#) [REF102AU/2K5](#) [TL4050B25QDBZR](#) [TL4051C12QDCKR](#) [TL431ACZ](#) [KA431SLMF2TF](#)
[KA431SMF2TF](#) [KA431SMFTF](#) [LM385BXZ/NOPB](#) [LM4040QCEM3-3.0/NOPB](#) [LM4041C12ILPR](#) [LM4050AEM3X-5.0/NOPB](#)
[LM4050AIM3X-5.0/NOPB](#) [LM4120AIM5-2.5/NOP](#) [LM431SCCMFX](#)