

## **500MHz Low Power Current Feedback Amplifiers with Enable**

The EL5162, EL5163, EL5262, EL5263, and EL5362 are current feedback amplifiers with a bandwidth of 500MHz. This makes these amplifiers ideal for today's high speed video and monitor applications.

With a supply current of just 1.5mA and the ability to run from a single supply voltage from 5V to 12V, these amplifiers are also ideal for handheld, portable or battery-powered equipment.

The EL5162 also incorporates an enable and disable function to reduce the supply current to 100 $\mu$ A typical per amplifier. Allowing the CE pin to float or applying a low logic level will enable the amplifier.

The EL5162 is available in 6 Ld SOT-23 and 8 Ld SOIC packages, the EL5163 in 5 Ld SOT-23 and SC-70 packages, the EL5262 in the 10 Ld MSOP package, the EL5263 in 8 Ld MSOP and SO packages, and the EL5362 in 16 Ld SOIC (0.150") and QSOP packages. All operate over the industrial temperature range of -40°C to +85°C.

## **Features**

- 500MHz to 3dB bandwidth
- 4000V/ $\mu$ s slew rate
- 1.5mA supply current
- Single and dual supply operation, from 5V to 12V supply span
- Fast enable/disable (EL5162, EL5262 and EL5362 only)
- Available in SOT-23 packages
- Pb-free available (RoHS compliant)
- High speed, 1.4GHz product available (EL5167 and EL5167)
- High speed, 4mA, 630MHz product available (EL5164 and EL5165)

## **Applications**

- Battery-powered equipment
- Handheld, portable devices
- Video amplifiers
- Cable drivers
- RGB amplifiers
- Test equipment
- Instrumentation
- Current to voltage converters

**EL5162, EL5163, EL5262, EL5263, EL5362**

**Ordering Information**

PART NUMBER	PART MARKING	PACKAGE	PKG. DWG. #
EL5162IS	5162IS	8 Ld SOIC (150 mil)	MDP0027
EL5162IS-T7*	5162IS	8 Ld SOIC (150 mil)	MDP0027
EL5162IS-T13*	5162IS	8 Ld SOIC (150 mil)	MDP0027
EL5162ISZ (Note)	5162ISZ	8 Ld SOIC (150 mil) (Pb-free)	MDP0027
EL5162ISZ-T7* (Note)	5162ISZ	8 Ld SOIC (150 mil) (Pb-free)	MDP0027
EL5162ISZ-T13* (Note)	5162ISZ	8 Ld SOIC (150 mil) (Pb-free)	MDP0027
EL5162IW-T7*	j	6 Ld SOT-23	MDP0038
EL5162IW-T7A*	j	6 Ld SOT-23	MDP0038
EL5162IWZ-T7* (Note)	BAKA	6 Ld SOT-23 (Pb-free)	MDP0038
EL5162IWZ-T7A* (Note)	BAKA	6 Ld SOT-23 (Pb-free)	MDP0038
EL5163IW-T7*	d	5 Ld SOT-23	MDP0038
EL5163IW-T7A*	d	5 Ld SOT-23	MDP0038
EL5163IWZ-T7* (Note)	BALA	5 Ld SOT-23 (Pb-free)	MDP0038
EL5163IWZ-T7A* (Note)	BALA	5 Ld SOT-23 (Pb-free)	MDP0038
EL5163IC-T7*	E	5 Ld SC-70 (1.25mm)	P5.049
EL5163IC-T7A*	E	5 Ld SC-70 (1.25mm)	P5.049
EL5163ICZ-T7* (Note)	BDA	5 Ld SC-70 (1.25mm) (Pb-free)	P5.049
EL5163ICZ-T7A* (Note)	BDA	5 Ld SC-70 (1.25mm) (Pb-free)	P5.049
EL5262IY	BLAAA	10 Ld MSOP (3.0mm)	MDP0043
EL5262IY-T7*	BLAAA	10 Ld MSOP (3.0mm)	MDP0043
EL5262IY-T13*	BLAAA	10 Ld MSOP (3.0mm)	MDP0043
EL5262IYZ (Note)	BBTAA	10 Ld MSOP (3.0mm) (Pb-free)	MDP0043
EL5262IYZ-T7* (Note)	BBTAA	10 Ld MSOP (3.0mm) (Pb-free)	MDP0043
EL5262IYZ-T13* (Note)	BBTAA	10 Ld MSOP (3.0mm) (Pb-free)	MDP0043
EL5263IS	5263IS	8 Ld SOIC (150 mil)	MDP0027
EL5263IS-T7*	5263IS	8 Ld SOIC (150 mil)	MDP0027
EL5263IS-T13*	5263IS	8 Ld SOIC (150 mil)	MDP0027
EL5263ISZ (Note)	5263ISZ	8 Ld SOIC (150 mil) (Pb-free)	MDP0027
EL5263ISZ-T7* (Note)	5263ISZ	8 Ld SOIC (150 mil) (Pb-free)	MDP0027
EL5263ISZ-T13* (Note)	5263ISZ	8 Ld SOIC (150 mil) (Pb-free)	MDP0027
EL5263IY	BMAAA	8 Ld MSOP (3.0mm)	MDP0043
EL5263IY-T7*	BMAAA	8 Ld MSOP (3.0mm)	MDP0043
EL5263IY-T13*	BMAAA	8 Ld MSOP (3.0mm)	MDP0043
EL5263IYZ (Note)	BBBJA	8 Ld MSOP (3.0mm) (Pb-free)	MDP0043
EL5263IYZ-T7* (Note)	BBBJA	8 Ld MSOP (3.0mm) (Pb-free)	MDP0043
EL5263IYZ-T13* (Note)	BBBJA	8 Ld MSOP (3.0mm) (Pb-free)	MDP0043
EL5362IS	EL5362IS	16 Ld SOIC (150 mil)	MDP0027
EL5362IS-T7*	EL5362IS	16 Ld SOIC (150 mil)	MDP0027
EL5362IS-T13*	EL5362IS	16 Ld SOIC (150 mil)	MDP0027

**Ordering Information** (Continued)

PART NUMBER	PART MARKING	PACKAGE	PKG. DWG. #
EL5362ISZ (Note)	EL5362ISZ	16 Ld SOIC (150 mil) (Pb-free)	MDP0027
EL5362ISZ-T7* (Note)	EL5362ISZ	16 Ld SOIC (150 mil) (Pb-free)	MDP0027
EL5362ISZ-T13* (Note)	EL5362ISZ	16 Ld SOIC (150 mil) (Pb-free)	MDP0027
EL5362IU	5362IU	16 Ld QSOP (150 mil)	MDP0040
EL5362IU-T7*	5362IU	16 Ld QSOP (150 mil)	MDP0040
EL5362IU-T13*	5362IU	16 Ld QSOP (150 mil)	MDP0040
EL5362IUZ (Note)	5362IUZ	16 Ld QSOP (Pb-free)	MDP0040
EL5362IUZ-T7* (Note)	5362IUZ	16 Ld QSOP (Pb-free)	MDP0040
EL5362IUZ-T13* (Note)	5362IUZ	16 Ld QSOP (Pb-free)	MDP0040

\*Please refer to TB347 for details on reel specifications.

NOTE: These Intersil Pb-free plastic packaged products employ special Pb-free material sets; molding compounds/die attach materials and 100% matte tin plate PLUS ANNEAL - e3 termination finish, which is RoHS compliant and compatible with both SnPb and Pb-free soldering operations. Intersil Pb-free products are MSL classified at Pb-free peak reflow temperatures that meet or exceed the Pb-free requirements of IPC/JEDEC J STD-020.

Pinouts

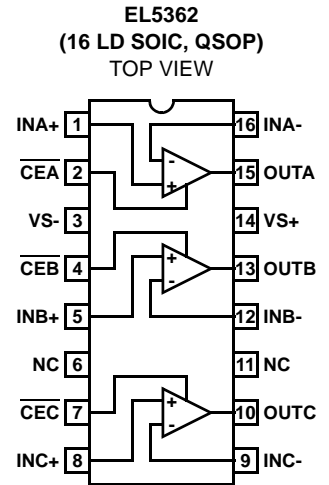
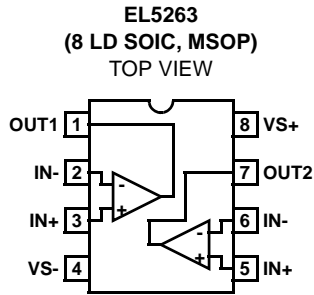
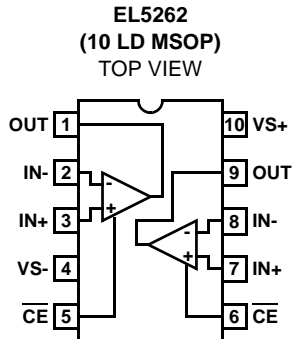
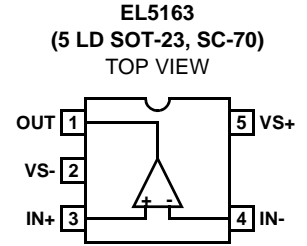
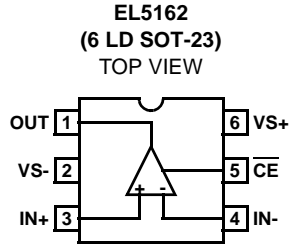
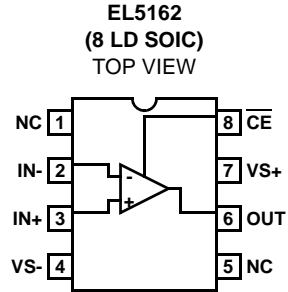

# EL5162, EL5163, EL5262, EL5263, EL5362

## Absolute Maximum Ratings (T<sub>A</sub> = +25°C)

Supply Voltage between V <sub>S+</sub> and V <sub>S-</sub> . . . . .	13.2V
Maximum Continuous Output Current . . . . .	50mA
Slewrate of V <sub>S+</sub> to V <sub>S-</sub> . . . . .	1V/μs
Maximum Voltage between IN+ and IN-, disabled . . . . .	±1.5V
Current into IN+, IN-, CE . . . . .	±5mA
Pin Voltages . . . . .	V <sub>S-</sub> -0.5V to V <sub>S+</sub> +0.5V

## Thermal Information

Storage Temperature . . . . .	-65°C to +150°C
Ambient Operating Temperature . . . . .	-40°C to +85°C
Operating Junction Temperature . . . . .	+125°C
Power Dissipation . . . . .	See Curves
Pb-free reflow profile . . . . .	see link below
	<a href="http://www.intersil.com/pbfree/Pb-FreeReflow.asp">http://www.intersil.com/pbfree/Pb-FreeReflow.asp</a>

**CAUTION:** Do not operate at or near the maximum ratings listed for extended periods of time. Exposure to such conditions may adversely impact product reliability and result in failures not covered by warranty.

**IMPORTANT NOTE:** All parameters having Min/Max specifications are guaranteed. Typical values are for information purposes only. Unless otherwise noted, all tests are at the specified temperature and are pulsed tests, therefore: T<sub>J</sub> = T<sub>C</sub> = T<sub>A</sub>

**Electrical Specifications** V<sub>S+</sub> = +5V, V<sub>S-</sub> = -5V, R<sub>F</sub> = 750Ω for A<sub>V</sub> = 1, R<sub>F</sub> = 400Ω for A<sub>V</sub> = 2, R<sub>L</sub> = 150Ω, T<sub>A</sub> = +25°C unless otherwise specified.

PARAMETER	DESCRIPTION	CONDITIONS	MIN	TYP	MAX	UNIT
<b>AC PERFORMANCE</b>						
BW	-3dB Bandwidth	A <sub>V</sub> = +1, R <sub>L</sub> = 500Ω, R <sub>F</sub> = 598Ω		500		MHz
		A <sub>V</sub> = +2, R <sub>L</sub> = 150Ω, R <sub>F</sub> = 422Ω		233		MHz
BW1	0.1dB Bandwidth			30		MHz
SR	Slew Rate	V <sub>O</sub> = -2.5V to +2.5V, A <sub>V</sub> = +2, R <sub>L</sub> = 100Ω (EL5262, EL5263, EL5362)	2000	2500	4000	V/μs
		V <sub>O</sub> = -2.5V to +2.5V, A <sub>V</sub> = +2, R <sub>L</sub> = 100Ω (EL5162, EL5163)	2800	4000	6000	V/μs
t <sub>S</sub>	0.1% Settling Time	V <sub>OUT</sub> = -2.5V to +2.5V, A <sub>V</sub> = +1		25		ns
e <sub>N</sub>	Input Voltage Noise			3		nV/√Hz
i <sub>N-</sub>	IN- Input Current Noise			10		pA/√Hz
i <sub>N+</sub>	IN+ Input Current Noise			6.5		pA/√Hz
dG	Differential Gain Error (Note 1)	A <sub>V</sub> = +2		0.05		%
dP	Differential Phase Error (Note 1)	A <sub>V</sub> = +2		0.15		°
<b>DC PERFORMANCE</b>						
V <sub>OS</sub>	Offset Voltage		-5	1.5	+5	mV
T <sub>C</sub> V <sub>OS</sub>	Input Offset Voltage Temperature Coefficient	Measured from T <sub>MIN</sub> to T <sub>MAX</sub>		6		μV/°C
R <sub>OL</sub>	Transimpedance		500	1000		kΩ
<b>INPUT CHARACTERISTICS</b>						
CMIR	Common Mode Input Range	Guaranteed by CMRR test	±3	±3.3		V
CMRR	Common Mode Rejection Ratio	V <sub>IN</sub> = ±3V	50	62	75	dB
-ICMR	- Input Current Common Mode Rejection		-1	0.22	+1	μA/V
+I <sub>IN</sub>	+ Input Current		-8	0.5	+8	μA
-I <sub>IN</sub>	- Input Current		-10	2	+10	μA
R <sub>IN</sub>	Input Resistance		0.8	1.6	3	MΩ
C <sub>IN</sub>	Input Capacitance			1		pF
<b>OUTPUT CHARACTERISTICS</b>						
V <sub>O</sub>	Output Voltage Swing	R <sub>L</sub> = 150Ω to GND	±3.35	±3.6	±3.75	V
		R <sub>L</sub> = 1kΩ to GND	±3.75	±3.9	±4.15	V
I <sub>OUT</sub>	Output Current	R <sub>L</sub> = 10Ω to GND	60	100		mA

**EL5162, EL5163, EL5262, EL5263, EL5362**

**Electrical Specifications**  $V_{S+} = +5V$ ,  $V_{S-} = -5V$ ,  $R_F = 750\Omega$  for  $A_V = 1$ ,  $R_F = 400\Omega$  for  $A_V = 2$ ,  $R_L = 150\Omega$ ,  $T_A = +25^\circ C$  unless otherwise specified. **(Continued)**

PARAMETER	DESCRIPTION	CONDITIONS	MIN	TYP	MAX	UNIT
<b>SUPPLY</b>						
$I_{SON}$	Supply Current - Enabled, per Amplifier	No load, $V_{IN} = 0V$	1.3	1.5	2.0	mA
$I_{SOFF-}$	Supply Current - Disabled, per Amplifier	No load, $V_{IN} = 0V$	-25	-14	0	$\mu A$
$I_{SOFF+}$			0	10	+25	$\mu A$
PSRR	Power Supply Rejection Ratio	DC, $V_S = \pm 4.75V$ to $\pm 5.25V$	65	76		dB
-IPSR	- Input Current Power Supply Rejection	DC, $V_S = \pm 4.75V$ to $\pm 5.25V$	-0.5	0.1	+0.5	$\mu A/V$
<b>ENABLE (EL5162, EL5262, EL5362 ONLY)</b>						
$t_{EN}$	Enable Time			380		ns
$t_{DIS}$	Disable Time			800		ns
$I_{IHCE}$	$\overline{CE}$ Pin Input High Current	$\overline{CE} = V_{S+}$	1	5	25	$\mu A$
$I_{ILCE}$	$\overline{CE}$ Pin Input Low Current	$\overline{CE} = (V_{S+}) - 5V$	-1	0	+1	$\mu A$
$V_{IHCE}$	$\overline{CE}$ Input High Voltage for Power-down		$V_{S+} - 1$			V
$V_{ILCE}$	$\overline{CE}$ Input Low Voltage for Power-down				$V_{S+} - 3$	V

NOTE:

- Standard NTSC test, AC signal amplitude = 286mV<sub>p-p</sub>, f = 3.58MHz

Typical Performance Curves

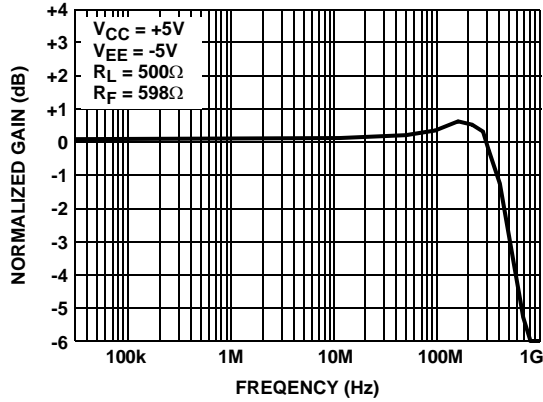

FIGURE 1. FREQUENCY RESPONSE FOR  $A_V = +1$

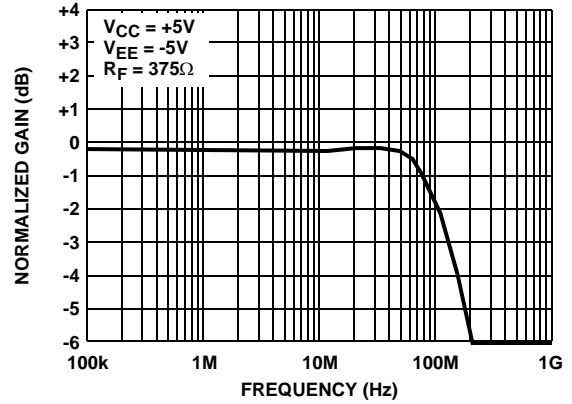

FIGURE 2. FREQUENCY RESPONSE FOR  $A_V = +4.6$

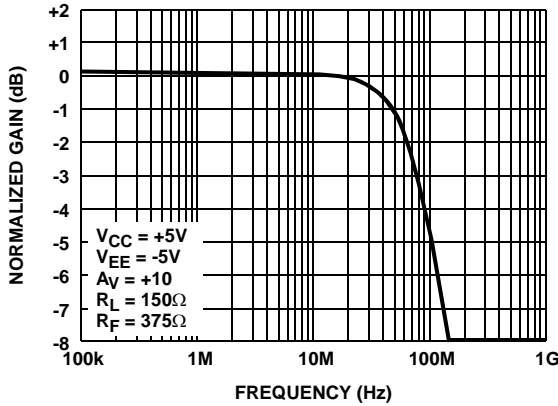

FIGURE 3. FREQUENCY RESPONSE FOR  $A_V = +10$

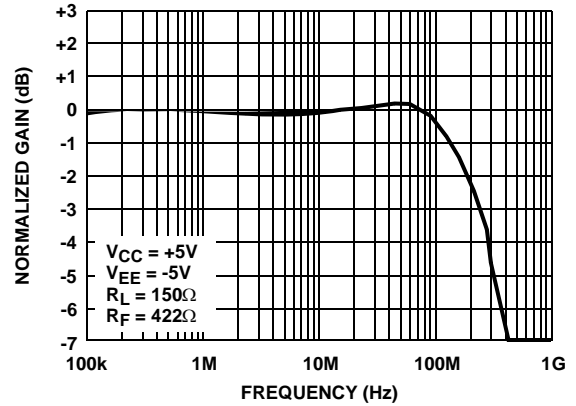

FIGURE 4. FREQUENCY RESPONSE FOR  $A_V = +2$

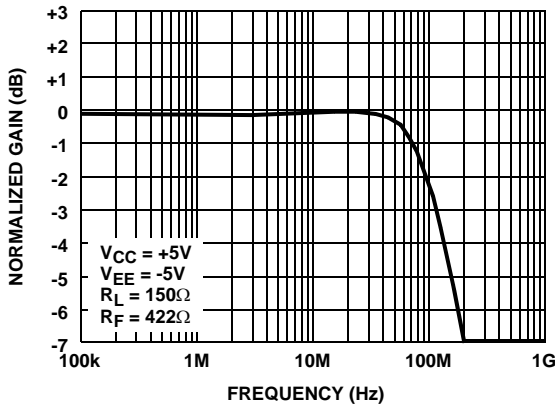

FIGURE 5. FREQUENCY RESPONSE FOR  $A_V = +4$

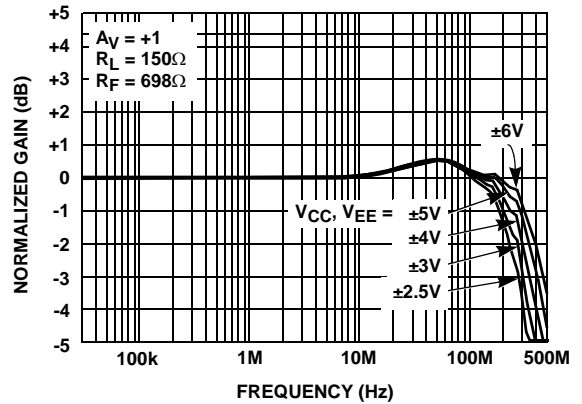

FIGURE 6. FREQUENCY RESPONSE FOR VARIOUS  $V_{CC}$ ,  $V_{EE}$

Typical Performance Curves (Continued)

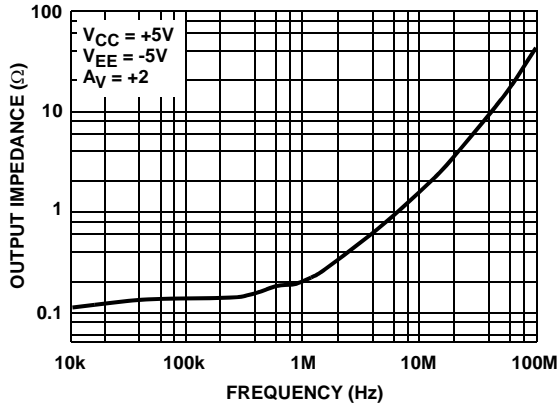

FIGURE 7. CLOSED LOOP OUTPUT IMPEDANCE

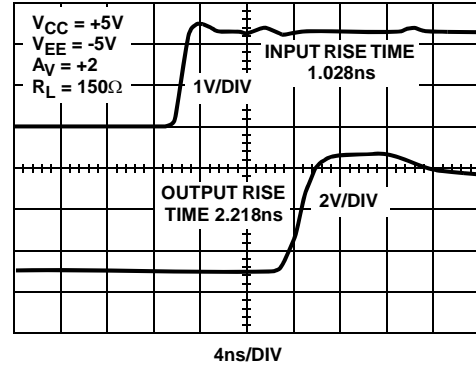

FIGURE 8. EL5262 OUTPUT RISE TIME

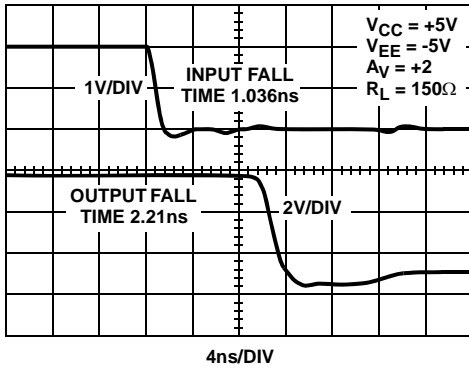

FIGURE 9. EL5262 OUTPUT FALL TIME

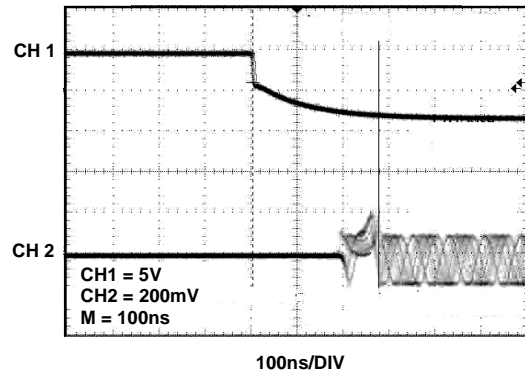

FIGURE 10. TURN ON TIME

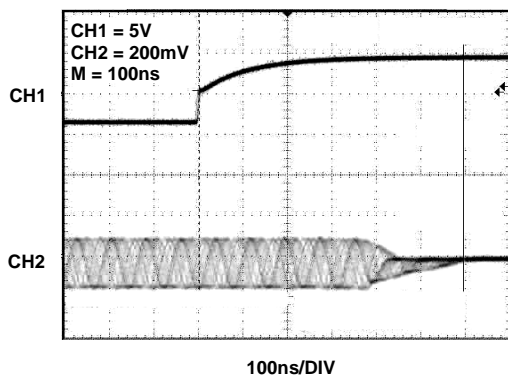

FIGURE 11. TURN OFF TIME

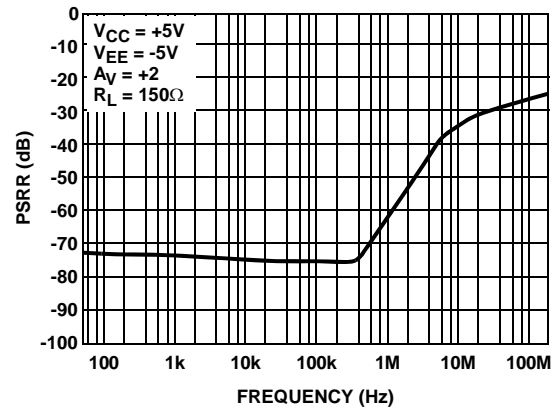

FIGURE 12. PSRR ( $V_{CC}$ )



Typical Performance Curves (Continued)

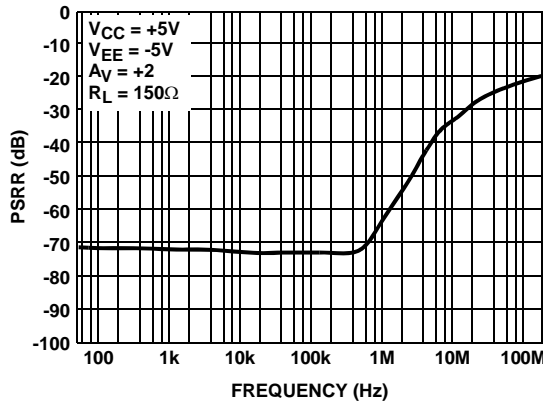

FIGURE 13. PSRR ( $V_{EE}$ )

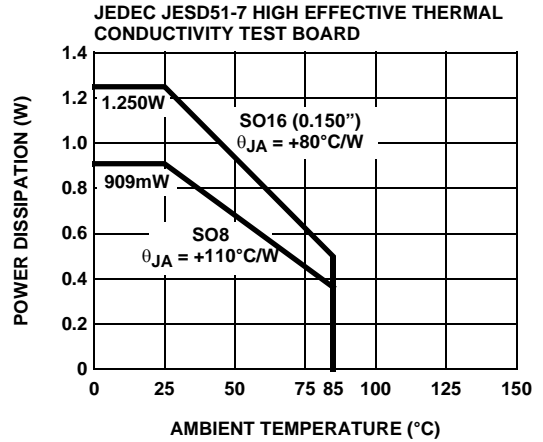

FIGURE 14. PACKAGE POWER DISSIPATION vs AMBIENT TEMPERATURE

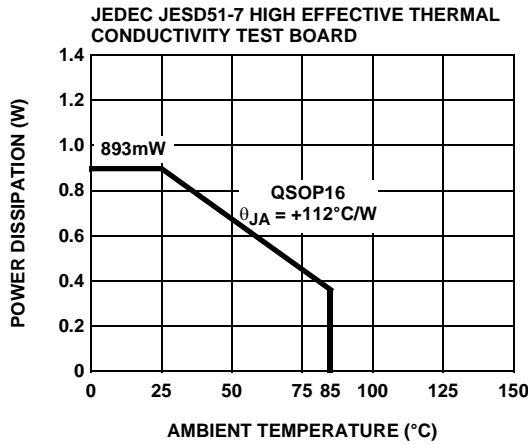

FIGURE 15. PACKAGE POWER DISSIPATION vs AMBIENT TEMPERATURE

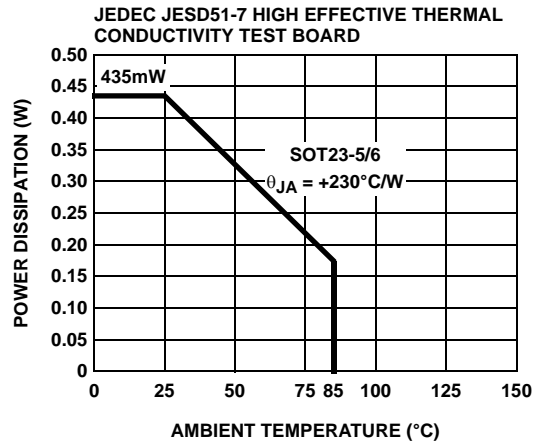

FIGURE 16. PACKAGE POWER DISSIPATION vs AMBIENT TEMPERATURE

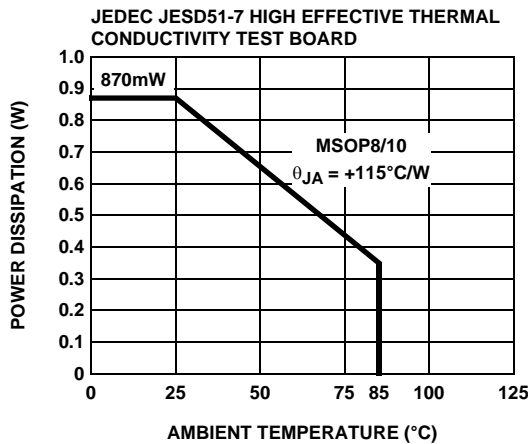

FIGURE 17. PACKAGE POWER DISSIPATION vs AMBIENT TEMPERATURE

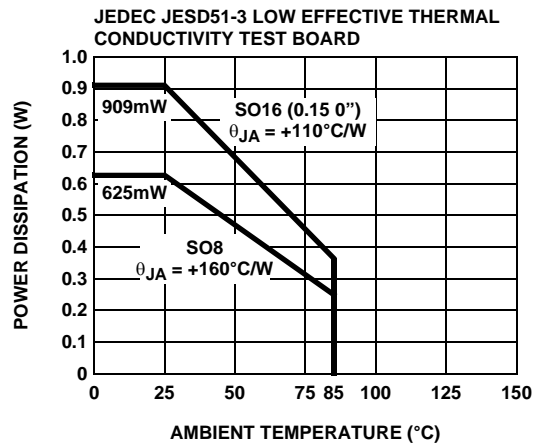

FIGURE 18. PACKAGE POWER DISSIPATION vs AMBIENT TEMPERATURE

Typical Performance Curves (Continued)

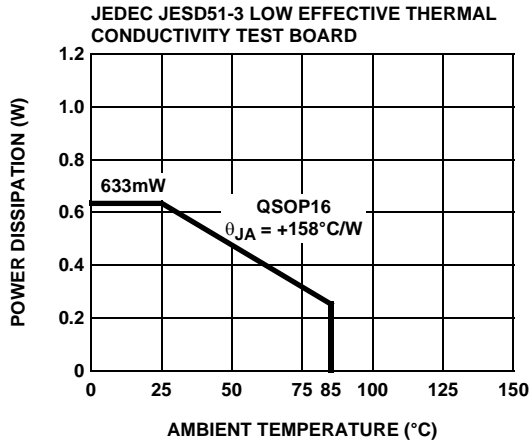

FIGURE 19. PACKAGE POWER DISSIPATION vs AMBIENT TEMPERATURE

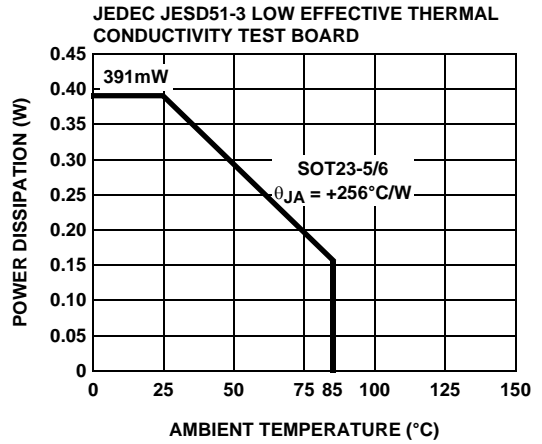

FIGURE 20. PACKAGE POWER DISSIPATION vs AMBIENT TEMPERATURE

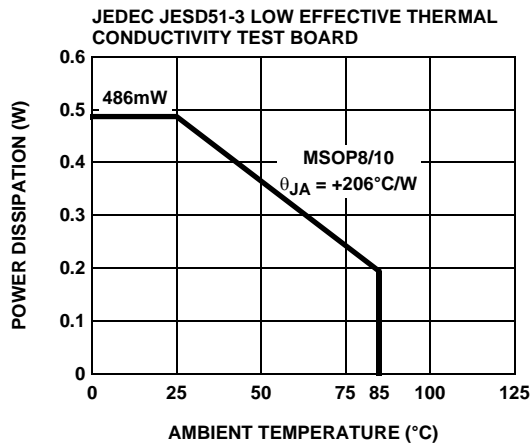
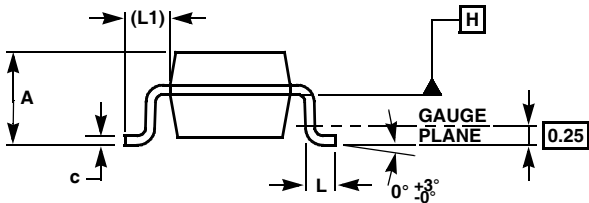
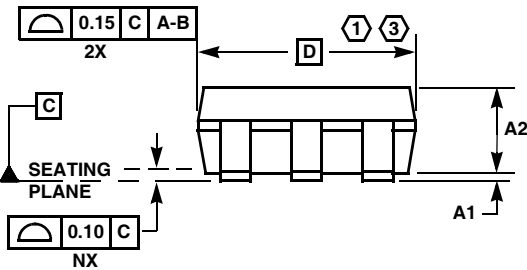
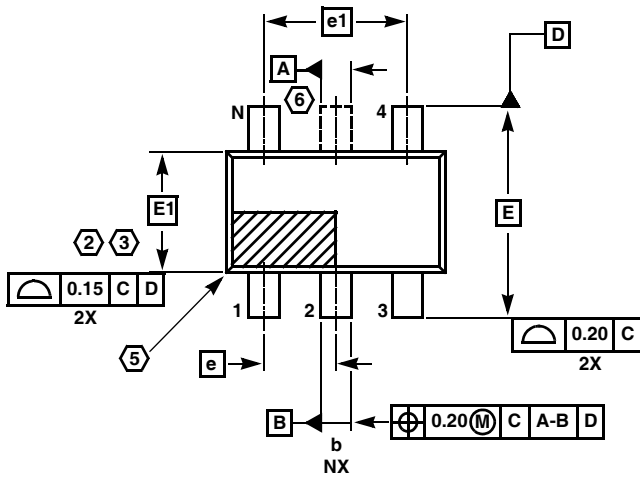

FIGURE 21. PACKAGE POWER DISSIPATION vs AMBIENT TEMPERATURE

SOT-23 Package Family



MDP0038

SOT-23 PACKAGE FAMILY

SYMBOL	MILLIMETERS		TOLERANCE
	SOT23-5	SOT23-6	
A	1.45	1.45	MAX
A1	0.10	0.10	±0.05
A2	1.14	1.14	±0.15
b	0.40	0.40	±0.05
c	0.14	0.14	±0.06
D	2.90	2.90	Basic
E	2.80	2.80	Basic
E1	1.60	1.60	Basic
e	0.95	0.95	Basic
e1	1.90	1.90	Basic
L	0.45	0.45	±0.10
L1	0.60	0.60	Reference
N	5	6	Reference

Rev. F 2/07

NOTES:

1. Plastic or metal protrusions of 0.25mm maximum per side are not included.
2. Plastic interlead protrusions of 0.25mm maximum per side are not included.
3. This dimension is measured at Datum Plane "H".
4. Dimensioning and tolerancing per ASME Y14.5M-1994.
5. Index area - Pin #1 I.D. will be located within the indicated zone (SOT23-6 only).
6. SOT23-5 version has no center lead (shown as a dashed line).

**Small Outline Package Family (SO)**

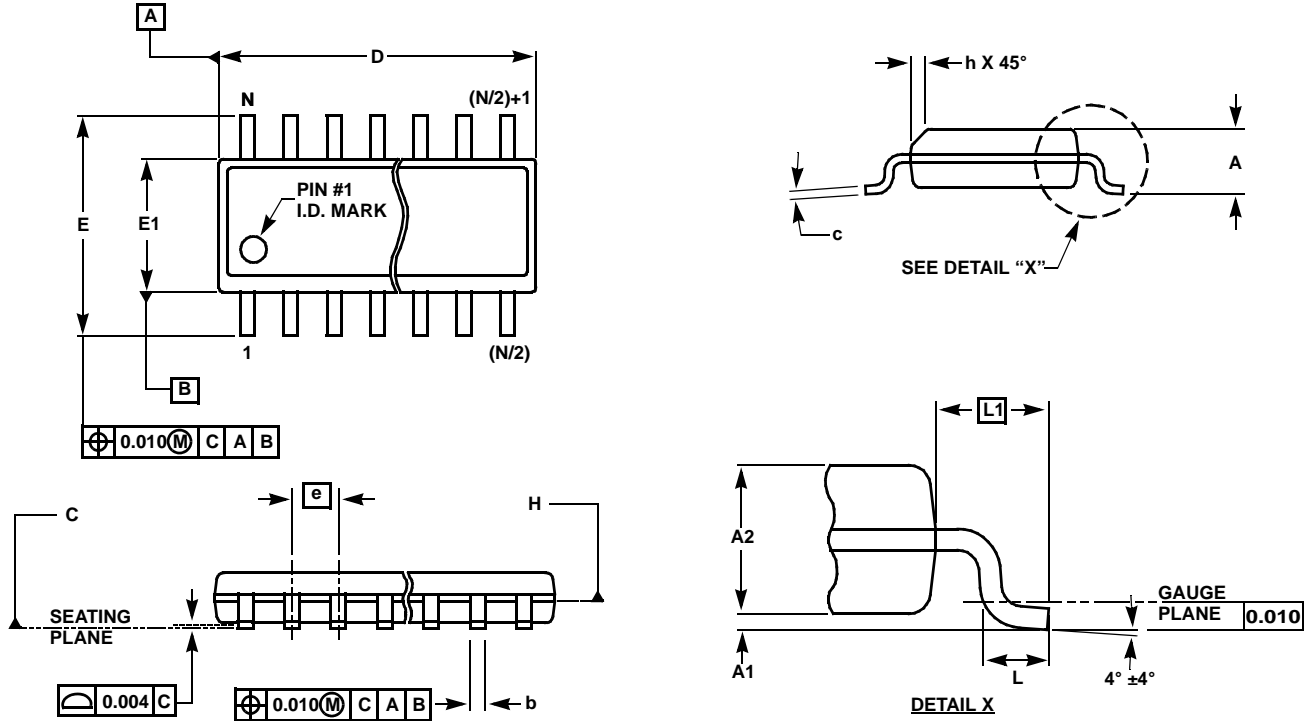

**MDP0027**

**SMALL OUTLINE PACKAGE FAMILY (SO)**

SYMBOL	INCHES							TOLERANCE	NOTES
	SO-8	SO-14	SO16 (0.150")	SO16 (0.300") (SOL-16)	SO20 (SOL-20)	SO24 (SOL-24)	SO28 (SOL-28)		
A	0.068	0.068	0.068	0.104	0.104	0.104	0.104	MAX	-
A1	0.006	0.006	0.006	0.007	0.007	0.007	0.007	±0.003	-
A2	0.057	0.057	0.057	0.092	0.092	0.092	0.092	±0.002	-
b	0.017	0.017	0.017	0.017	0.017	0.017	0.017	±0.003	-
c	0.009	0.009	0.009	0.011	0.011	0.011	0.011	±0.001	-
D	0.193	0.341	0.390	0.406	0.504	0.606	0.704	±0.004	1, 3
E	0.236	0.236	0.236	0.406	0.406	0.406	0.406	±0.008	-
E1	0.154	0.154	0.154	0.295	0.295	0.295	0.295	±0.004	2, 3
e	0.050	0.050	0.050	0.050	0.050	0.050	0.050	Basic	-
L	0.025	0.025	0.025	0.030	0.030	0.030	0.030	±0.009	-
L1	0.041	0.041	0.041	0.056	0.056	0.056	0.056	Basic	-
h	0.013	0.013	0.013	0.020	0.020	0.020	0.020	Reference	-
N	8	14	16	16	20	24	28	Reference	-

Rev. M 2/07

**NOTES:**

1. Plastic or metal protrusions of 0.006" maximum per side are not included.
2. Plastic interlead protrusions of 0.010" maximum per side are not included.
3. Dimensions "D" and "E1" are measured at Datum Plane "H".
4. Dimensioning and tolerancing per ASME Y14.5M-1994

Small Outline Transistor Plastic Packages (SC70-5)

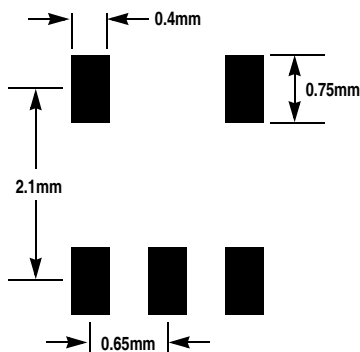
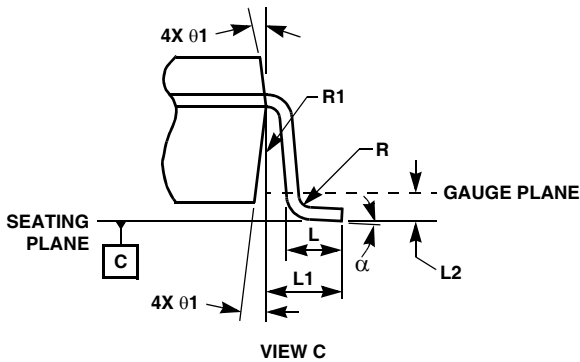
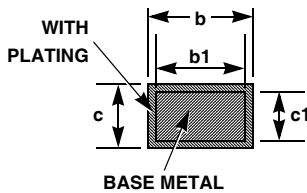
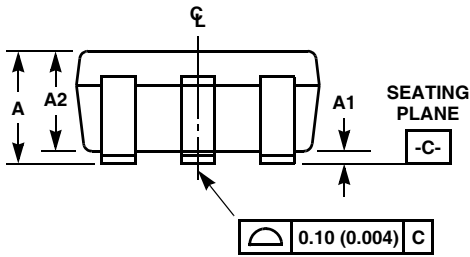
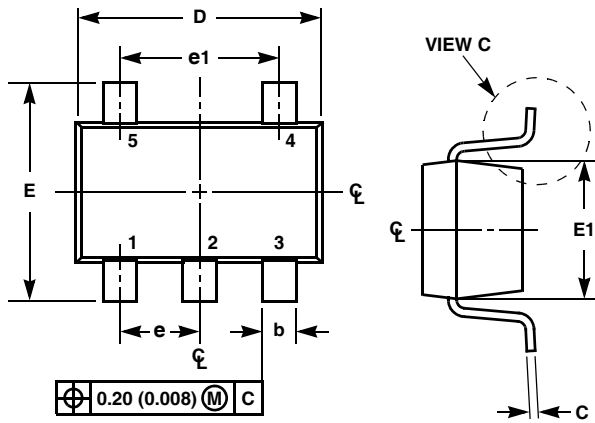

TYPICAL RECOMMENDED LAND PATTERN

P5.049

5 LEAD SMALL OUTLINE TRANSISTOR PLASTIC PACKAGE

SYMBOL	INCHES		MILLIMETERS		NOTES
	MIN	MAX	MIN	MAX	
A	0.031	0.043	0.80	1.10	-
A1	0.000	0.004	0.00	0.10	-
A2	0.031	0.039	0.80	1.00	-
b	0.006	0.012	0.15	0.30	-
b1	0.006	0.010	0.15	0.25	-
c	0.003	0.009	0.08	0.22	6
c1	0.003	0.009	0.08	0.20	6
D	0.073	0.085	1.85	2.15	3
E	0.071	0.094	1.80	2.40	-
E1	0.045	0.053	1.15	1.35	3
e	0.0256 Ref		0.65 Ref		-
e1	0.0512 Ref		1.30 Ref		-
L	0.010	0.018	0.26	0.46	4
L1	0.017 Ref.		0.420 Ref.		-
L2	0.006 BSC		0.15 BSC		-
α	0°	8°	0°	8°	-
N	5		5		5
R	0.004	-	0.10	-	-
R1	0.004	0.010	0.15	0.25	-

Rev. 3 7/07

NOTES:

1. Dimensioning and tolerances per ASME Y14.5M-1994.
2. Package conforms to EIAJ SC70 and JEDEC MO-203AA.
3. Dimensions D and E1 are exclusive of mold flash, protrusions, or gate burrs.
4. Footlength L measured at reference to gauge plane.
5. "N" is the number of terminal positions.
6. These Dimensions apply to the flat section of the lead between 0.08mm and 0.15mm from the lead tip.
7. Controlling dimension: MILLIMETER. Converted inch dimensions are for reference only.

Mini SO Package Family (MSOP)

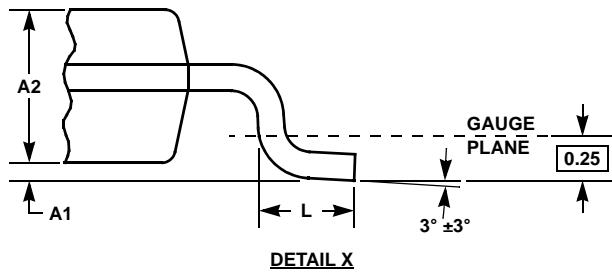
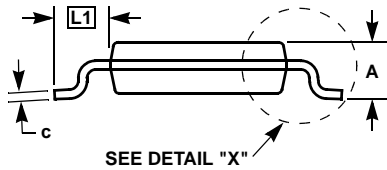
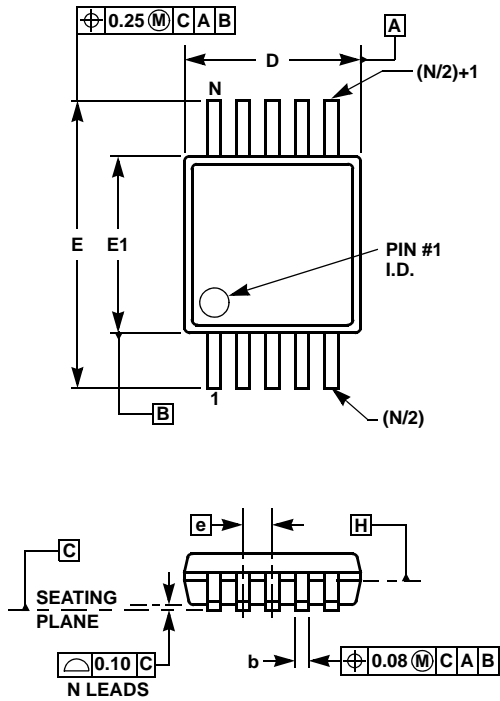

MDP0043  
MINI SO PACKAGE FAMILY

SYMBOL	MILLIMETERS		TOLERANCE	NOTES
	MSOP8	MSOP10		
A	1.10	1.10	Max.	-
A1	0.10	0.10	±0.05	-
A2	0.86	0.86	±0.09	-
b	0.33	0.23	+0.07/-0.08	-
c	0.18	0.18	±0.05	-
D	3.00	3.00	±0.10	1, 3
E	4.90	4.90	±0.15	-
E1	3.00	3.00	±0.10	2, 3
e	0.65	0.50	Basic	-
L	0.55	0.55	±0.15	-
L1	0.95	0.95	Basic	-
N	8	10	Reference	-

Rev. D 2/07

NOTES:

1. Plastic or metal protrusions of 0.15mm maximum per side are not included.
2. Plastic interlead protrusions of 0.25mm maximum per side are not included.
3. Dimensions "D" and "E1" are measured at Datum Plane "H".
4. Dimensioning and tolerancing per ASME Y14.5M-1994.

Quarter Size Outline Plastic Packages Family (QSOP)

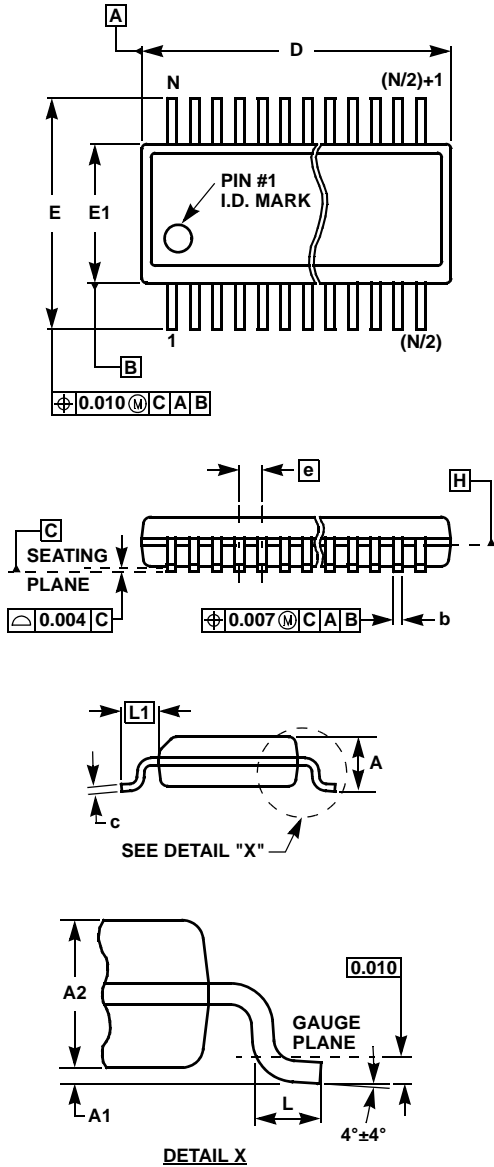

MDP0040

QUARTER SIZE OUTLINE PLASTIC PACKAGES FAMILY

SYMBOL	INCHES			TOLERANCE	NOTES
	QSOP16	QSOP24	QSOP28		
A	0.068	0.068	0.068	Max.	-
A1	0.006	0.006	0.006	$\pm 0.002$	-
A2	0.056	0.056	0.056	$\pm 0.004$	-
b	0.010	0.010	0.010	$\pm 0.002$	-
c	0.008	0.008	0.008	$\pm 0.001$	-
D	0.193	0.341	0.390	$\pm 0.004$	1, 3
E	0.236	0.236	0.236	$\pm 0.008$	-
E1	0.154	0.154	0.154	$\pm 0.004$	2, 3
e	0.025	0.025	0.025	Basic	-
L	0.025	0.025	0.025	$\pm 0.009$	-
L1	0.041	0.041	0.041	Basic	-
N	16	24	28	Reference	-

Rev. F 2/07

NOTES:

1. Plastic or metal protrusions of 0.006" maximum per side are not included.
2. Plastic interlead protrusions of 0.010" maximum per side are not included.
3. Dimensions "D" and "E1" are measured at Datum Plane "H".
4. Dimensioning and tolerancing per ASME Y14.5M-1994.

All Intersil U.S. products are manufactured, assembled and tested utilizing ISO9000 quality systems. Intersil Corporation's quality certifications can be viewed at [www.intersil.com/design/quality](http://www.intersil.com/design/quality)

*Intersil products are sold by description only. Intersil Corporation reserves the right to make changes in circuit design, software and/or specifications at any time without notice. Accordingly, the reader is cautioned to verify that data sheets are current before placing orders. Information furnished by Intersil is believed to be accurate and reliable. However, no responsibility is assumed by Intersil or its subsidiaries for its use; nor for any infringements of patents or other rights of third parties which may result from its use. No license is granted by implication or otherwise under any patent or patent rights of Intersil or its subsidiaries.*

For information regarding Intersil Corporation and its products, see [www.intersil.com](http://www.intersil.com)

## X-ON Electronics

Largest Supplier of Electrical and Electronic Components

*Click to view similar products for [Renesas](#) manufacturer:*

Other Similar products are found below :

[062191EB](#) [099448X](#) [099508GB](#) [10070R-43-54](#) [1214-001](#) [1280-060](#) [1289-004](#) [14450R-500](#) [14550R-500](#) [2308A-1DCG8](#) [23S09E-1HDCGI8](#)  
[2.5MM-NUT-E](#) [2SA1226-T1B-A](#) [2SA1647-Z-AZ](#) [2SA1648-AZ](#) [2SA1741-AZ](#) [2SA1744-AZ](#) [2SA811A-T1B-A](#) [2SB1578-T1-AZ](#)  
[2SB1691WL-TL-E](#) [2SB963-AZ](#) [2SC2223-T1B-A](#) [2SC3518-Z-AZ](#) [2SC3632-AZ](#) [2SC4550-AZ](#) [2SC4552-AZ](#) [2SC4554-AZ](#) [2SD1615-T1-AZ](#)  
[2SD780-T1B-A](#) [2SJ202-T1-A](#) [2SJ496TZ-E](#) [2SJ542-E](#) [2SJ599-AZ](#) [2SJ606-AZ](#) [2SJ687-ZK-E1-AY](#) [2SK1254S-E](#) [2SK1317-01-E](#)  
[2SK1838STR-E](#) [2SK2053-T1-AZ](#) [2SK2413-T-AZ](#) [2SK3054-T1-A](#) [2SK3354-AZ](#) [2SK3367-Z-E1-AZ](#) [2SK3408-T1B-A](#) [2SK3446TZ-E](#)  
[2SK3480-AZ](#) [2SK3483-Z-AZ](#) [2SK3793-AZ](#) [3.5MM-NUT-E](#) [40222R](#)