

## 2-Phase, High Speed CCD Driver

The EL7182 is extremely well suited for driving CCD's, especially where high contrast imaging is desirable. The 16V supply rating is attractive for higher voltage CCD applications, as in color fax machines. The input is TTL and 3V compatible. The low quiescent current requirement is advantageous in portable/battery powered systems. The EL7182 is available in 8 Ld PDIP and 8 Ld SOIC packages.

### Pinout

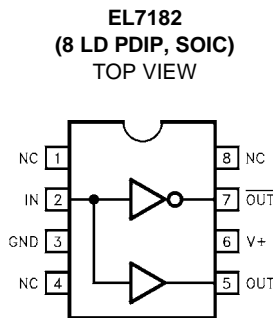

Manufactured under U.S. Patent Nos. 5,334,883, #5,341,047

### Features

- 3V and 5V Input compatible
- Clocking speeds up to 10MHz
- Reduced clock skew
- 20ns Switching/delay time
- 2A Peak drive
- Low quiescent current
- Wide operating voltage: 4.5V–16V
- Pb-free plus anneal available (RoHS compliant)

### Applications

- CCD Drivers requiring high-contrast imaging
- Differential line drivers
- Push-pull circuits

### Ordering Information

| PART NUMBER             | PART MARKING | TEMP. RANGE (°C)                          | PACKAGE                | PKG. DWG. # |
|-------------------------|--------------|---|------------------------|-------------|
| EL7182CN                | EL7182CN     | -40 to +85                                | 8 Ld PDIP              | MDP0031     |
| EL7182CS                | 7182CS       | -40 to +85                                | 8 Ld SOIC              | MDP0027     |
| EL7182CSZ<br>(Note)     | 7182CSZ      | -40 to +85                                | 8 Ld SOIC<br>(Pb-free) | MDP0027     |
| EL7182CSZ-T7<br>(Note)  | 7182CSZ      | 8 Ld SOIC (7" Tape and Reel)<br>(Pb-free) |                        |             |
| EL7182CSZ-T13<br>(Note) | 7182CSZ      | 8 Ld SOIC (7" Tape and Reel)<br>(Pb-free) |                        |             |

NOTE: Intersil Pb-free plus anneal products employ special Pb-free material sets; molding compounds/die attach materials and 100% matte tin plate termination finish, which are RoHS compliant and compatible with both SnPb and Pb-free soldering operations. Intersil Pb-free products are MSL classified at Pb-free peak reflow temperatures that meet or exceed the Pb-free requirements of IPC/JEDEC J STD-020.

**Absolute Maximum Ratings** ( $T_A = 25^\circ\text{C}$ )

|   |                         |  |        |
|---|-------------------------|--|--------|
| Supply (V+ to Gnd) . . . . .            | 16.5V                   | Operating Junction Temperature . . . . . | 125°C  |
| Input Pins . . . . .                    | -0.3V to +0.3V above V+ | Power Dissipation                        |        |
| Combined Peak Output Current . . . . .  | .4A                     | SOIC . . . . .                           | .570mW |
| Storage Temperature Range . . . . .     | -65°C to +150°C         | PDIP . . . . .                           | 1050mW |
| Ambient Operating Temperature . . . . . | -40°C to +85°C          |  |        |

*CAUTION: Stresses above those listed in "Absolute Maximum Ratings" may cause permanent damage to the device. This is a stress only rating and operation of the device at these or any other conditions above those indicated in the operational sections of this specification is not implied.*

*IMPORTANT NOTE: All parameters having Min/Max specifications are guaranteed. Typical values are for information purposes only. Unless otherwise noted, all tests are at the specified temperature and are pulsed tests, therefore:  $T_J = T_C = T_A$*

**Electrical Specifications**  $T_A = 25^\circ\text{C}$ ,  $V = 15\text{V}$  unless otherwise specified

| PARAMETER           | DESCRIPTION               | TEST CONDITIONS           | MIN | TYP | MAX | UNITS         |
|---------------------|---------------------------|---------------------------|-----|-----|-----|---------------|
| <b>INPUT</b>        |                           |                           |     |     |     |               |
| $V_{IH}$            | Logic "1" Input Voltage   |                           | 2.4 |     |     | V             |
| $I_{IH}$            | Logic "1" Input Current   | @V+                       |     | 0.1 | 10  | $\mu\text{A}$ |
| $V_{IL}$            | Logic "0" Input Voltage   |                           |     |     | 0.8 | V             |
| $I_{IL}$            | Logic "0" Input Current   | @0V                       |     | 0.1 | 10  | $\mu\text{A}$ |
| $V_{HVS}$           | Input Hysteresis          |                           |     | 0.3 |     | V             |
| <b>OUTPUT</b>       |                           |                           |     |     |     |               |
| $R_{OH}$            | Pull-Up Resistance        | $I_{OUT} = -100\text{mA}$ |     | 3   | 6   | $\Omega$      |
| $R_{OL}$            | Pull-Down Resistance      | $I_{OUT} = +100\text{mA}$ |     | 4   | 6   | $\Omega$      |
| $I_{PK}$            | Peak Output Current       | Source                    |     | 2   |     | A             |
|                     |                           | Sink                      |     | 2   |     | A             |
| $I_{DC}$            | Continuous Output Current | Source/Sink               | 100 |     |     | mA            |
| <b>POWER SUPPLY</b> |                           |                           |     |     |     |               |
| $I_S$               | Power Supply Current      | Input High                |     | 2.5 | 5   | mA            |
| $V_S$               | Operating Voltage         |                           | 4.5 |     | 16  | V             |

**AC Electrical Specifications**  $T_A = 25^\circ\text{C}$ ,  $V = 15\text{V}$  unless otherwise specified

| PARAMETER                        | DESCRIPTION         | TEST CONDITIONS       | MIN | TYP | MAX | UNITS |
|----------------------------------|---------------------|-----------------------|-----|-----|-----|-------|
| <b>SWITCHING CHARACTERISTICS</b> |                     |                       |     |     |     |       |
| $t_R$                            | Rise Time           | $C_L = 500\text{pF}$  |     | 7.5 |     | ns    |
|                                  |                     | $C_L = 1000\text{pF}$ |     | 10  | 20  | ns    |
| $t_F$                            | Fall Time           | $C_L = 500\text{pF}$  |     | 10  |     | ns    |
|                                  |                     | $C_L = 1000\text{pF}$ |     | 13  | 20  | ns    |
| $t_{D-ON}$                       | Turn-On Delay Time  |                       |     | 18  | 25  | ns    |
| $t_{D-OFF}$                      | Turn-Off Delay Time |                       |     | 20  | 25  | ns    |

**Timing Table**

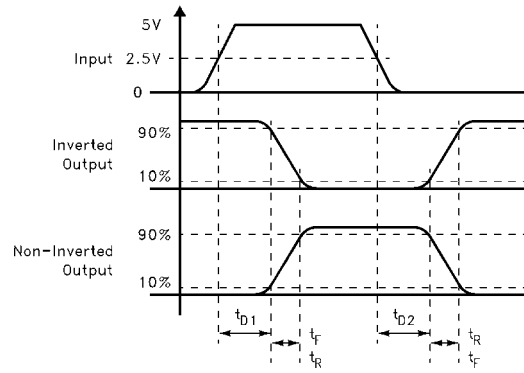

**Standard Test Configuration**

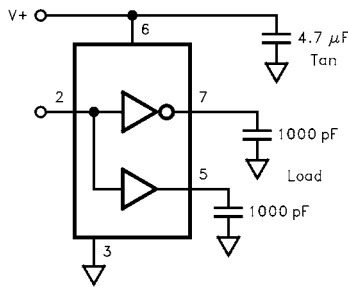

**Simplified Schematic**

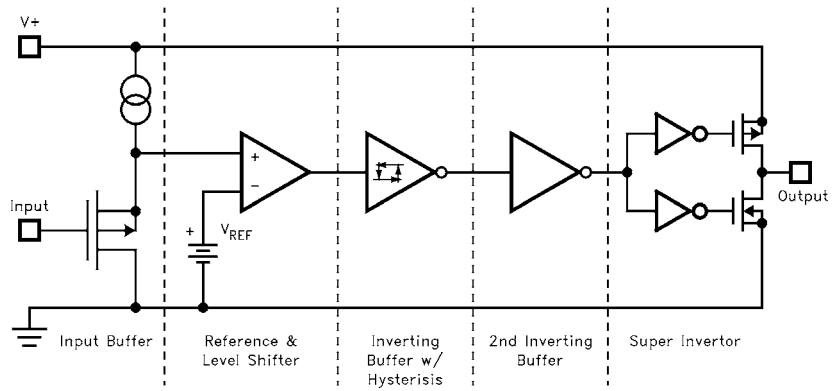

Typical Performance Curves

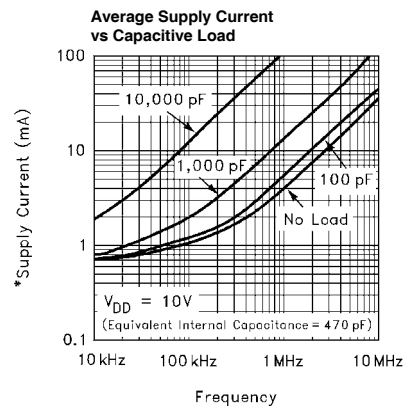
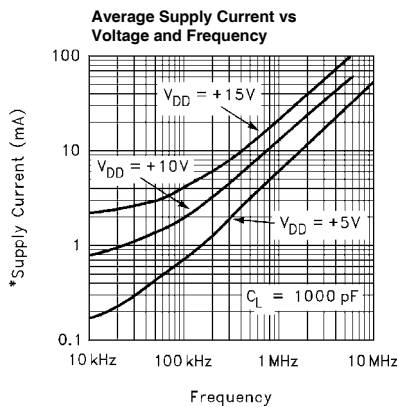
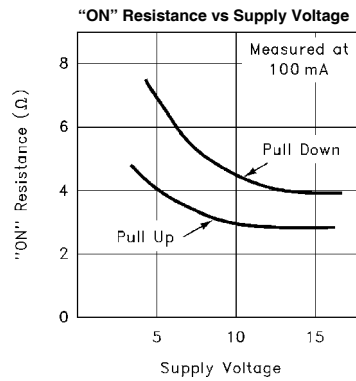
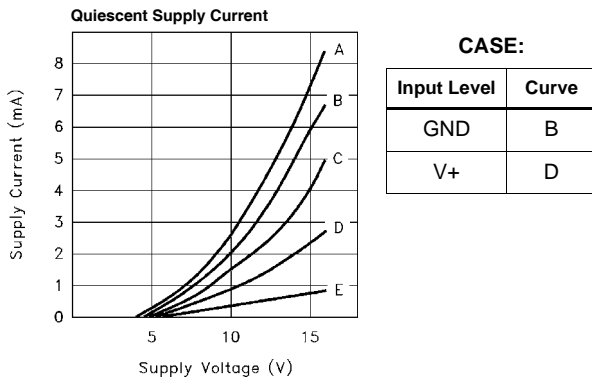
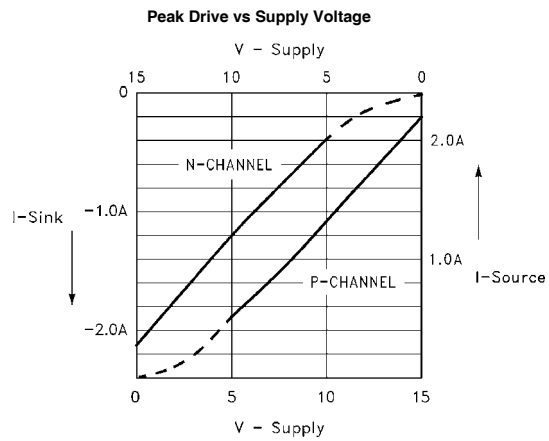
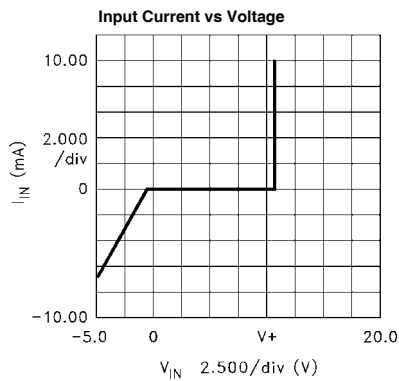
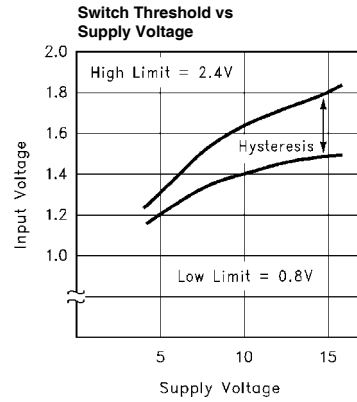
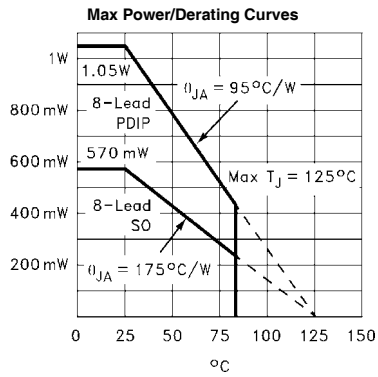

Typical Performance Curves (Continued)

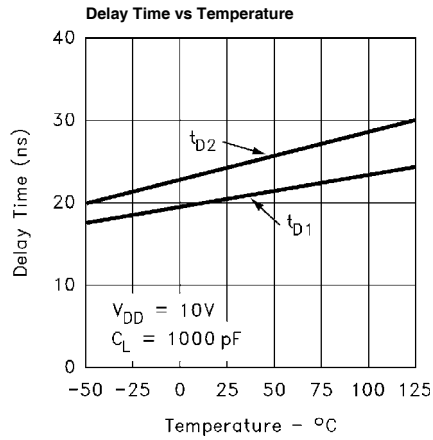
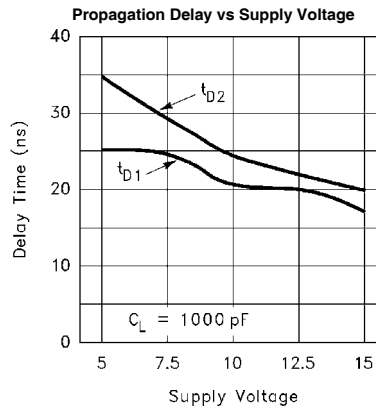
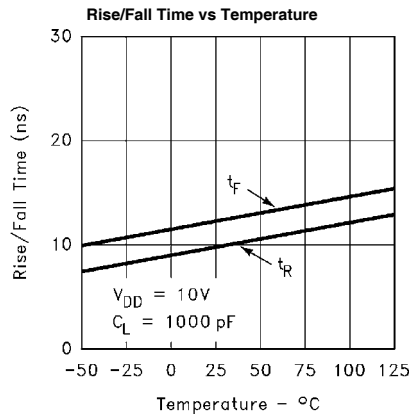
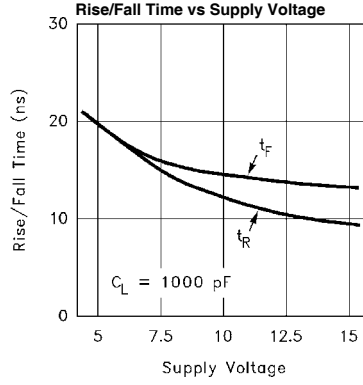
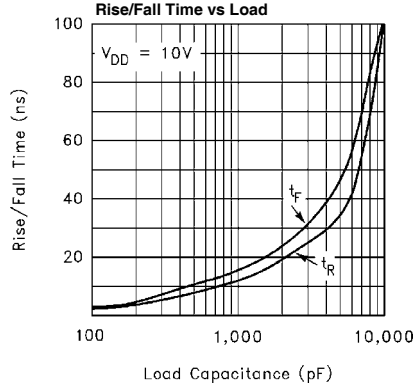

**Small Outline Package Family (SO)**

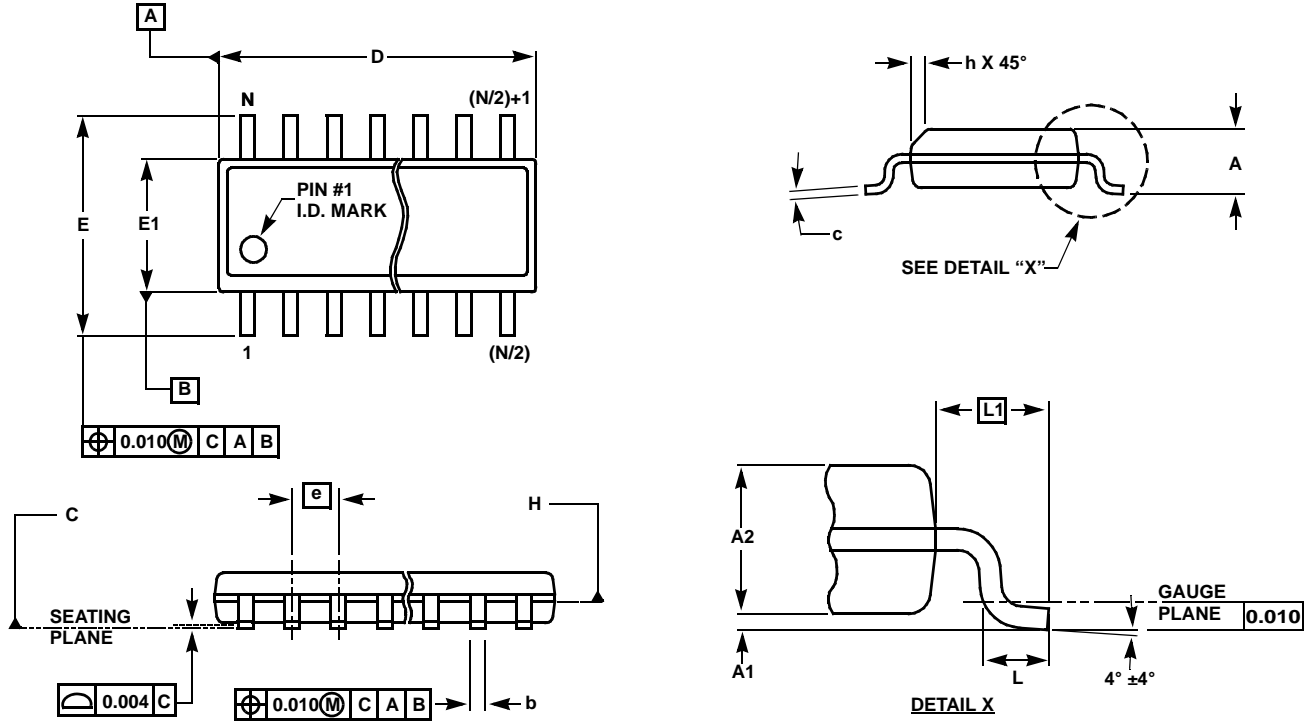

**MDP0027**

**SMALL OUTLINE PACKAGE FAMILY (SO)**

| SYMBOL | SO-8  | SO-14 | SO16<br>(0.150") | SO16 (0.300")<br>(SOL-16) | SO20<br>(SOL-20) | SO24<br>(SOL-24) | SO28<br>(SOL-28) | TOLERANCE | NOTES |
|--------|-------|-------|------------------|---------------------------|------------------|------------------|------------------|-----------|-------|
| A      | 0.068 | 0.068 | 0.068            | 0.104                     | 0.104            | 0.104            | 0.104            | MAX       | -     |
| A1     | 0.006 | 0.006 | 0.006            | 0.007                     | 0.007            | 0.007            | 0.007            | ±0.003    | -     |
| A2     | 0.057 | 0.057 | 0.057            | 0.092                     | 0.092            | 0.092            | 0.092            | ±0.002    | -     |
| b      | 0.017 | 0.017 | 0.017            | 0.017                     | 0.017            | 0.017            | 0.017            | ±0.003    | -     |
| c      | 0.009 | 0.009 | 0.009            | 0.011                     | 0.011            | 0.011            | 0.011            | ±0.001    | -     |
| D      | 0.193 | 0.341 | 0.390            | 0.406                     | 0.504            | 0.606            | 0.704            | ±0.004    | 1, 3  |
| E      | 0.236 | 0.236 | 0.236            | 0.406                     | 0.406            | 0.406            | 0.406            | ±0.008    | -     |
| E1     | 0.154 | 0.154 | 0.154            | 0.295                     | 0.295            | 0.295            | 0.295            | ±0.004    | 2, 3  |
| e      | 0.050 | 0.050 | 0.050            | 0.050                     | 0.050            | 0.050            | 0.050            | Basic     | -     |
| L      | 0.025 | 0.025 | 0.025            | 0.030                     | 0.030            | 0.030            | 0.030            | ±0.009    | -     |
| L1     | 0.041 | 0.041 | 0.041            | 0.056                     | 0.056            | 0.056            | 0.056            | Basic     | -     |
| h      | 0.013 | 0.013 | 0.013            | 0.020                     | 0.020            | 0.020            | 0.020            | Reference | -     |
| N      | 8     | 14    | 16               | 16                        | 20               | 24               | 28               | Reference | -     |

Rev. L 2/01

**NOTES:**

1. Plastic or metal protrusions of 0.006" maximum per side are not included.
2. Plastic interlead protrusions of 0.010" maximum per side are not included.
3. Dimensions "D" and "E1" are measured at Datum Plane "H".
4. Dimensioning and tolerancing per ASME Y14.5M-1994

**Plastic Dual-In-Line Packages (PDIP)**

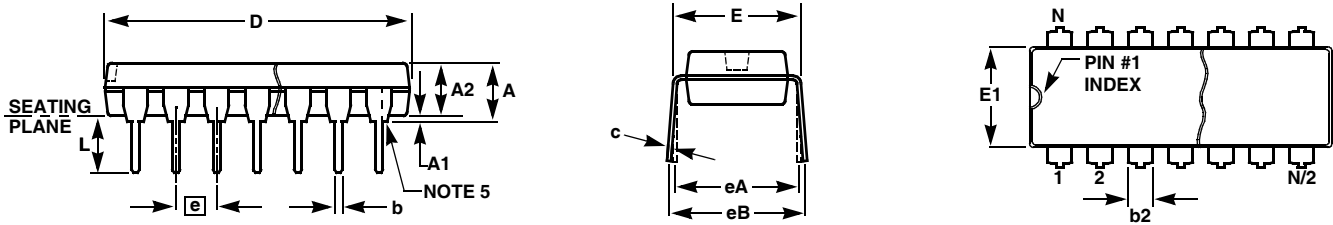

**MDP0031  
PLASTIC DUAL-IN-LINE PACKAGE**

| SYMBOL | PDIP8 | PDIP14 | PDIP16 | PDIP18 | PDIP20 | TOLERANCE     | NOTES |
|--------|-------|--------|--------|--------|--------|---------------|-------|
| A      | 0.210 | 0.210  | 0.210  | 0.210  | 0.210  | MAX           |       |
| A1     | 0.015 | 0.015  | 0.015  | 0.015  | 0.015  | MIN           |       |
| A2     | 0.130 | 0.130  | 0.130  | 0.130  | 0.130  | ±0.005        |       |
| b      | 0.018 | 0.018  | 0.018  | 0.018  | 0.018  | ±0.002        |       |
| b2     | 0.060 | 0.060  | 0.060  | 0.060  | 0.060  | +0.010/-0.015 |       |
| c      | 0.010 | 0.010  | 0.010  | 0.010  | 0.010  | +0.004/-0.002 |       |
| D      | 0.375 | 0.750  | 0.750  | 0.890  | 1.020  | ±0.010        | 1     |
| E      | 0.310 | 0.310  | 0.310  | 0.310  | 0.310  | +0.015/-0.010 |       |
| E1     | 0.250 | 0.250  | 0.250  | 0.250  | 0.250  | ±0.005        | 2     |
| e      | 0.100 | 0.100  | 0.100  | 0.100  | 0.100  | Basic         |       |
| eA     | 0.300 | 0.300  | 0.300  | 0.300  | 0.300  | Basic         |       |
| eB     | 0.345 | 0.345  | 0.345  | 0.345  | 0.345  | ±0.025        |       |
| L      | 0.125 | 0.125  | 0.125  | 0.125  | 0.125  | ±0.010        |       |
| N      | 8     | 14     | 16     | 18     | 20     | Reference     |       |

Rev. B 2/99

**NOTES:**

1. Plastic or metal protrusions of 0.010" maximum per side are not included.
2. Plastic interlead protrusions of 0.010" maximum per side are not included.
3. Dimensions E and eA are measured with the leads constrained perpendicular to the seating plane.
4. Dimension eB is measured with the lead tips unconstrained.
5. 8 and 16 lead packages have half end-leads as shown.

All Intersil U.S. products are manufactured, assembled and tested utilizing ISO9000 quality systems.  
Intersil Corporation's quality certifications can be viewed at [www.intersil.com/design/quality](http://www.intersil.com/design/quality)

*Intersil products are sold by description only. Intersil Corporation reserves the right to make changes in circuit design, software and/or specifications at any time without notice. Accordingly, the reader is cautioned to verify that data sheets are current before placing orders. Information furnished by Intersil is believed to be accurate and reliable. However, no responsibility is assumed by Intersil or its subsidiaries for its use; nor for any infringements of patents or other rights of third parties which may result from its use. No license is granted by implication or otherwise under any patent or patent rights of Intersil or its subsidiaries.*

For information regarding Intersil Corporation and its products, see [www.intersil.com](http://www.intersil.com)

## X-ON Electronics

Largest Supplier of Electrical and Electronic Components

*Click to view similar products for [Gate Drivers](#) category:*

*Click to view products by [Renesas](#) manufacturer:*

Other Similar products are found below :

[00053P0231](#) [8967380000](#) [56956](#) [CR7E-30DB-3.96E\(72\)](#) [57.404.7355.5](#) [LT4936](#) [57.904.0755.0](#) [5803-0901](#) [58410](#) [5882900001](#) [00600P0005](#)  
[00-9050-LRPP](#) [00-9090-RDPP](#) [5951900000](#) [01-1003W-10/32-15](#) [LTLA6E-1S-WH-RC-FN12VXCR1](#) [0131700000](#) [00-2240](#) [LTP70N06](#)  
[LVP640](#) [0158-624-00](#) [5J0-1000LG-SIL](#) [020017-13](#) [LY1D-2-5S-AC120](#) [LY2-0-US-AC120](#) [LY2-US-AC240](#) [LY3-UA-DC24](#) [00-5150](#)  
[00576P0020](#) [00600P0010](#) [LZNQ2M-US-DC5](#) [LZNQ2-US-DC12](#) [LZP40N10](#) [00-8196-RDPP](#) [00-8274-RDPP](#) [00-8275-RDNP](#) [00-8609-](#)  
[RDPP](#) [00-8722-RDPP](#) [00-8728-WHPP](#) [00-8869-RDPP](#) [00-9051-RDPP](#) [00-9091-LRPP](#) [00-9291-RDPP](#) [0207100000](#) [0207400000](#) [60100564](#)  
[01312](#) [0134220000](#) [6035](#) [M15730061](#)