

### GENERAL DESCRIPTION

This document describes the specifications for the IDTF1102 Zero-Distortion™ RF to IF Downconverting Mixer. This device is part of a series of downconverting mixers covering all UTRA bands. See the Part# Matrix for the details of all devices in the series.

The F1102 dual channel device operates with a single 5V supply. It is optimized for operation in a Multi-carrier BaseStation Receiver for RF bands from 698 to 915 MHz with High or Low Side Injection. IF frequencies from 50 to 300 MHz are supported. The F1102 also supports the 400 MHz RF bands with some simple external matching modifications (see page 25). Nominally, the device offers +43 dBm Output IP3 with 330 mA of I<sub>CC</sub>. Alternately one can adjust 4 resistor values and a toggle pin to run the devices in low current mode (LC mode) with +36 dBm Output IP3 and 235 mA of I<sub>CC</sub>.

### COMPETITIVE ADVANTAGE

In typical basestation receivers the mixer limits the linearity performance for the entire receive system. The F1102 with Zero-Distortion technology dramatically improves the maximum IM<sub>3</sub> interference that the BTS can withstand at a desired Signal to Noise Ratio (SNR.) Alternately, one can run the device in LC Mode to reduce Power consumption significantly.

- ✓ IP<sub>30</sub>: ↑ **7 dB** STD Mode, ↑ **3 dB** LC Mode
- ✓ Dissipation: ↓ **40%** LC Mode, ↓ **12%** STD Mode
- ✓ Allows for higher RF gain improving **Sensitivity**



### FEATURES

- Dual Path for Diversity Systems
- Ideal for Multi-Carrier Systems
- 9.0 dB Gain
- Ultra linear:
  - **+43 dBm IP<sub>30</sub> (STD Mode)**
  - +36 dBm IP<sub>30</sub> (LC Mode)
- Low NF < 10 dB
- Extended LO level range for MIMO (-6 dBm)
- 200 Ω output impedance
- Ultra high +13 dBm P1dB<sub>I</sub>
- **Pin Compatible** with existing solutions
- 6x6 36 pin package
- **Power Down mode**
- < 200 nsec settling from Power Down
- Minimizes Synth pulling in Standby Mode
- Low Current Mode : **I<sub>CC</sub> = 235 mA**
- Standard Mode: I<sub>CC</sub> = 330 mA

### DEVICE BLOCK DIAGRAM

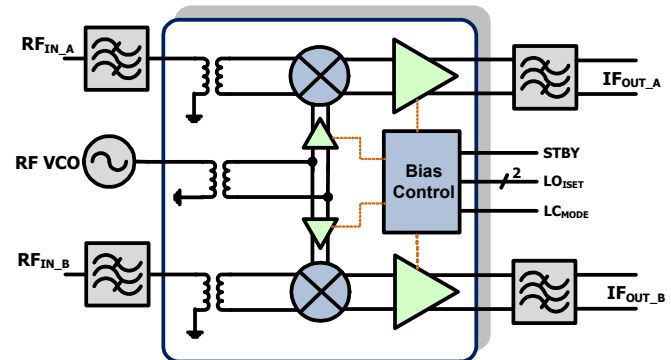

### PART# MATRIX

| Part#              | RF freq range     | UTRA bands   | IF freq range   | Typ. Gain  | Injection   |
|--------------------|-------------------|--|-----------------|------------|-------------|
| F1100              | 698 - 915         | 5,6,8,12,13,14,17,19,20  | 150 - 450       | 8.3        | High Side   |
| <b>F1102</b>       | <b>400 - 1000</b> | <b>5,6,8,12,13,14,17,19,20</b>   | <b>50 - 300</b> | <b>9.0</b> | <b>Both</b> |
| F1150 <sup>2</sup> | 1700 - 2200       | 1,2,3,4,9,10, 33, 34,35, 36, 37,39                                     | 50 - 450        | 8.5        | High Side   |
| F1152              | 1400 - 2200       | 1,2,3,4,9,10, 21 <sup>1</sup> , 24 <sup>1</sup> , 33, 34,35, 36, 37,39 | 50 - 350        | 8.5        | Low Side    |
| F1162              | 2300 – 2700       | 7,38,40,41 <sup>2</sup>  | 50 – 500        | 8.8        | Low Side    |

1 - with High side injection  
2 - With High side or Low side injection

### ORDERING INFORMATION

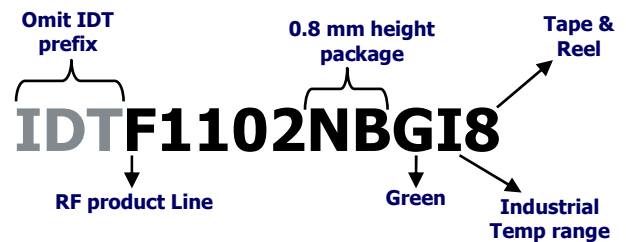

**ABSOLUTE MAXIMUM RATINGS**

|   |                                    |
|---|------------------------------------|
| VCC to GND  | -0.3V to +5.5V                     |
| STBY, LC <sub>MODE</sub>  | -0.3V to (VCC <sub>-</sub> + 0.3V) |
| IF_A+, IF_B+, IF_A-, IF_B-, LO1_ADJ, LO2_ADJ                              | -0.3V to (VCC <sub>-</sub> + 0.3V) |
| LO_IN, LO_IN_ALT, RF_A, RF_B  | -0.3V to +0.3V                     |
| IF_BiasA, IF_BiasB to GND   | -0.3V to +0.3V                     |
| RF Input Power (RF_A, RF_B)   | +20dBm                             |
| Continuous Power Dissipation  | 2.2W                               |
| $\theta_{JA}$ (Junction – Ambient)  | +35°C/W                            |
| $\theta_{JC}$ (Junction – Case) The Case is defined as the exposed paddle | +2.5°C/W                           |
| Operating Temperature Range (Case Temperature)                            | T <sub>C</sub> = -40°C to +100°C   |
| Maximum Junction Temperature  | 150°C                              |
| Storage Temperature Range   | -65°C to +150°C                    |
| Lead Temperature (soldering, 10s) .                                       | +260°C                             |

*Stresses above those listed above may cause permanent damage to the device. Functional operation of the device at these or any other conditions above those indicated in the operational section of this specification is not implied. Exposure to absolute maximum rating conditions for extended periods may affect device reliability.*

**IDTF1102 SPECIFICATION (400 – 1000 MHz MIXER w/HIGH OR LOW SIDE INJECTION)**

Specifications apply at  $V_{CC} = +5.0V$ ,  $F_{RF} = 850 \text{ MHz}$ ,  $F_{IF} = 200 \text{ MHz}$ , Hi-Side,  $P_{LO} = 0 \text{ dBm}$ ,  $T_C = +25^\circ\text{C}$ ,  $STBY = GND$ ,  $LC_{MODE} = V_{IH}$  (STD Mode), EVKit BOM = Standard Mode, Transformer Loss included (not de-embedded) unless otherwise noted.

| Parameter             | Comment   | Symbol           | min         | typ                     | max                    | units           |
|-----------------------|---|------------------|-------------|-------------------------|------------------------|-----------------|
| Logic Input High      | For Standby, $LC_{MODE}$ Pins   | $V_{IH}$         | <b>2</b>    |                         |                        | V               |
| Logic Input Low       | For Standby, $LC_{MODE}$ Pins   | $V_{IL}$         |             |                         | <b>0.8</b>             | V               |
| Logic Current         | For Standby Pin   | $I_{IH}, I_{IL}$ | <b>-30</b>  |                         | <b>+30</b>             | $\mu\text{A}$   |
| Logic Current         | $LC_{MODE}$ Pin   | $I_{IH}, I_{IL}$ | <b>-100</b> |                         | <b>-20</b>             | $\mu\text{A}$   |
| Supply Voltage(s)     | All $V_{CC}$ pins   | $V_{CC}$         |             | 4.75 to 5.25            |                        | V               |
| Operating Temperature | Case Temperature  | $T_{CASE}$       |             | -40 to +100             |                        | degC            |
| Supply Current        | Total $V_{CC}$ , STD Mode<br>▪ Total Both Channels  | $I_{STD}$        |             | <b>330</b>              | <b>370<sup>1</sup></b> | mA              |
| Supply Current        | Total $V_{CC}$ , LC Mode<br>▪ $LC_{MODE} = GND$<br>▪ EVkit BOM = LC Mode<br>▪ Total Both Channels   | $I_{LC}$         |             | <b>235</b>              | <b>260</b>             | mA              |
| Supply Current        | Standby Mode<br>▪ $STBY = V_{IH}$<br>▪ Total Both Channels<br>▪ STD Mode  | $I_{STBY}$       |             | <b>22</b>               | <b>30</b>              | mA              |
| RF Freq Range         | Operating Range   | $F_{RF}$         |             | 400 <sup>3</sup> – 1000 |                        | MHz             |
| IF Freq Range         | Operating Range   | $F_{IF}$         |             | 50 to 300               |                        | MHz             |
| LO Freq Range         | Operating LO Range  | $F_{LO}$         |             | 500 to 1150             |                        | MHz             |
| LO Power              | Operating LO Range  | $P_{LO}$         |             | -6 to +6                |                        | dBm             |
| RF Input Impedance    | Single Ended<br>Return Loss ~17 dB  | $Z_{RF}$         |             | 50                      |                        | $\Omega$        |
| IF Output Impedance   | Differential<br>Return Loss ~ 13 dB   | $Z_{IF}$         |             | 200                     |                        | $\Omega$        |
| LO port Impedance     | Single Ended<br>Return Loss ~15 dB  | $Z_{LO}$         |             | 50                      |                        | $\Omega$        |
| Settling Time         | • Pin = -13 dBm<br>• Gate STBY from $V_{IH}$ to $V_{IL}$<br>• Time for IF Signal to settle to within 0.1 dB of final value                          | $T_{SETT}$       |             | 0.175                   |                        | $\mu\text{sec}$ |
| Gain STD Mode         | Conversion Gain<br>• $F_{RF} = 698 \text{ MHz}$<br>• $LC_{MODE} = V_{IH}$<br>• EVkit BOM = STD Mode<br>• $F_{IF} = 150 \text{ MHz}$ (Low Side Inj.) | $G_{STD}$        | <b>8.5</b>  | <b>9.2</b>              | <b>9.9</b>             | dB              |
| Gain LC Mode          | Conversion Gain<br>• $F_{RF} = 915 \text{ MHz}$<br>• $LC_{MODE} = GND$<br>• EVkit BOM = LC Mode<br>• $F_{IF} = 200 \text{ MHz}$ (High Side Inj.)    | $G_{LC}$         | <b>7.8</b>  | <b>8.5</b>              | <b>9.2</b>             | dB              |

**IDTF1102 SPECIFICATION (CONTINUED)**

| Parameter                             | Comment   | Symbol             | min             | typ         | max | units |
|---------------------------------------|---|--------------------|-----------------|-------------|-----|-------|
| NF STD Mode                           | <ul style="list-style-type: none"> <li>LC<sub>MODE</sub> = V<sub>IH</sub></li> <li>EVkit BOM = STD Mode</li> <li>F<sub>IF</sub> = 200 MHz (High Side Inj.)</li> </ul>   | NF <sub>STD</sub>  |                 | 9.5         |     | dB    |
| NF LC Mode                            | <ul style="list-style-type: none"> <li>LC<sub>MODE</sub> = GND</li> <li>EVkit BOM = LC Mode</li> <li>F<sub>IF</sub> = 200 MHz (High Side Inj.)</li> </ul>   | NF <sub>LC</sub>   |                 | 9.3         |     | dB    |
| NF w/Blocker                          | <ul style="list-style-type: none"> <li>-100 MHz offset blocker</li> <li>P<sub>IN</sub> = +10 dBm</li> <li>F<sub>IF</sub> = 200 MHz</li> </ul>   | NF <sub>BLK</sub>  |                 | 21.7        |     | dB    |
| Output IP3 – Narrowband               | <ul style="list-style-type: none"> <li>P<sub>IN</sub> = -10 dBm per tone</li> <li>800 KHz Tone Separation</li> <li>F<sub>IF</sub> = 200 MHz (High Side Inj.)</li> <li>F<sub>RF</sub> = 850 MHz</li> </ul>   | IP3 <sub>O1</sub>  | 39 <sup>2</sup> | 43          |     | dBm   |
| Output IP3 – Wideband                 | <ul style="list-style-type: none"> <li>P<sub>IN</sub> = -10 dBm per tone</li> <li>15 MHz Tone Separation</li> <li>F<sub>IF</sub> = 200 MHz (High Side Inj.)</li> </ul>  | IP3 <sub>O2</sub>  |                 | 42          |     | dBm   |
| Output IP3 – LC <sub>MODE</sub>       | <ul style="list-style-type: none"> <li>P<sub>IN</sub> = -10 dBm per tone</li> <li>F<sub>IF</sub> = 200 MHz (High Side Inj.)</li> <li>800 KHz Tone Separation</li> <li>LC<sub>MODE</sub> = GND</li> <li>F<sub>RF</sub> = 915 MHz</li> </ul>        | IP3 <sub>O3</sub>  | <b>33</b>       | <b>36</b>   |     | dBm   |
| 2RF – 2LO rejection                   | <ul style="list-style-type: none"> <li>P<sub>RF</sub> = -10 dBm</li> <li>Frequency = F<sub>RF</sub> + ½ F<sub>IF</sub></li> </ul>   | 2x2                |                 | -78         |     | dBc   |
| 1 dB Compression                      | <ul style="list-style-type: none"> <li>Input referred</li> </ul>  | P1dB <sub>I1</sub> | 11.9            | 12.5        |     | dBm   |
| 1 dB Compression - LC <sub>MODE</sub> | <ul style="list-style-type: none"> <li>Input referred</li> <li>LC<sub>MODE</sub> = GND</li> </ul>   | P1dB <sub>I2</sub> | <b>9.0</b>      | <b>10.2</b> |     | dBm   |
| Gain Comp. w/blocker                  | <ul style="list-style-type: none"> <li>Blocker → unmodulated tone</li> <li>P<sub>IN</sub> = +8 dBm, 20 MHz offset</li> <li>Signal Pin Tone = -20 dBm</li> <li>Measure ΔG of signal</li> </ul>   | ΔG <sub>AC</sub>   |                 | 0.15        |     | dB    |
| Spur: 5RF X -4LO                      | <ul style="list-style-type: none"> <li>F<sub>LO</sub> = 1087.5 MHz</li> <li>F<sub>IF</sub> = 190 MHz (High Side Inj.)</li> <li>Desired F<sub>RF</sub> = 897.5 MHz</li> <li>Spur Freq = 908 MHz</li> <li>Pin = +5 dBm</li> <li>STD Mode</li> </ul> | SPUR <sub>1</sub>  |                 | -97         | -89 | dBc   |
| Channel Isolation                     | IF_B Pout vs. IF_A w/ RF_A input  | ISO <sub>C</sub>   | 45              | 51          |     | dB    |
| LO to IF leakage                      |   | ISO <sub>LI</sub>  |                 | -22         | -15 | dBm   |
| RF to IF leakage                      | Pin = -10 dBm   | ISO <sub>RI</sub>  |                 | -26         | -20 | dBm   |
| LO to RF leakage                      |   | ISO <sub>LR</sub>  |                 | -40         |     | dBm   |

**Notes:**

- 1 – Items in min/max columns in ***bold italics*** are Guaranteed by Test
- 2 – All other Items in min/max columns are Guaranteed by Design Characterization
- 3 – Normal RF range is 698 – 915 MHz. See Page 25 for modifications for 400 – 500 MHz operation

**TYPICAL OPERATING CONDITIONS**

Unless otherwise Noted, the following Apply to the Typ Ops Graphs

- 800 KHz Tone Spacing
- High Side injection graphs with 200MHz IF (pages 6 – 10)
- Low Side injection graphs with 150MHz IF (pages 11 – 14)
- Average of Channel A & Channel B
- Pin = – 10 dBm per Tone
- LO port = Pin 19 (Main Port)
- Listed Temperatures are Case Temperature ( $T_C$  or  $T_{CASE}$  = Case Temperature)
- Where noted,  $T_A$  or  $T_{AMB}$  = Ambient Temperature
- Transformer losses are de-embedded

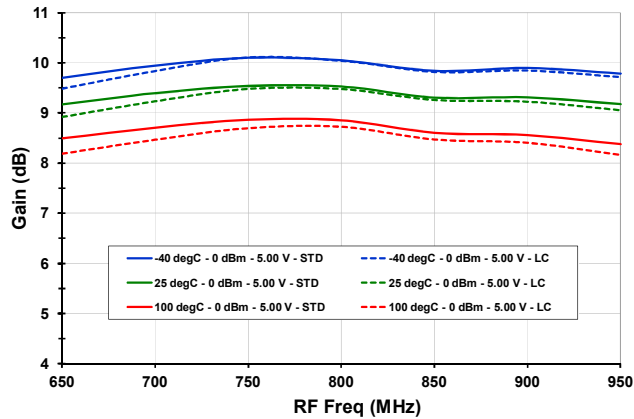
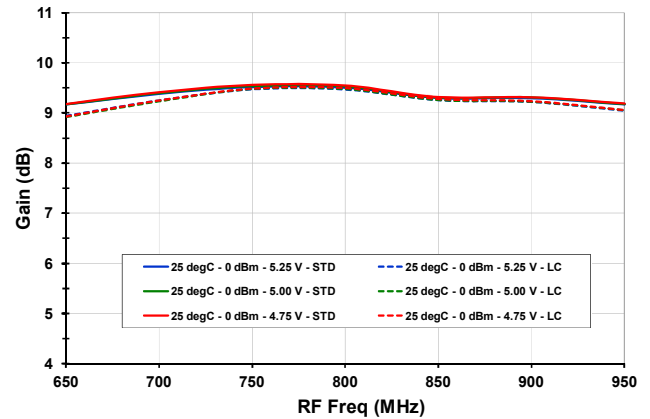
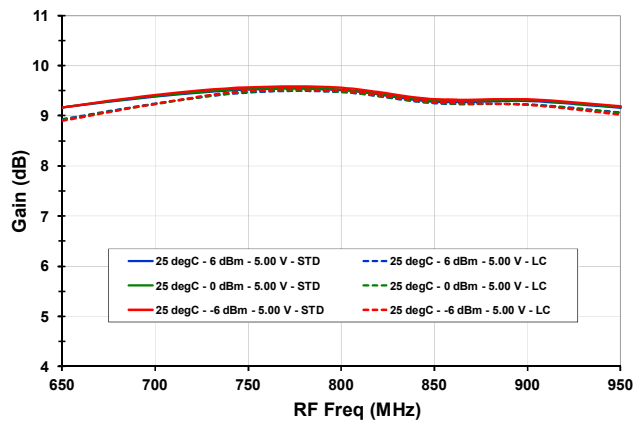
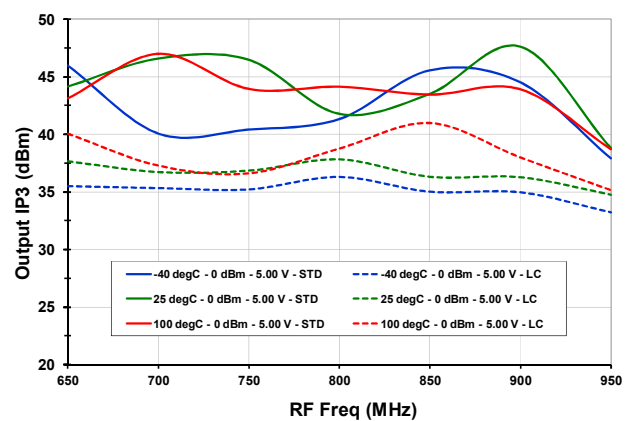
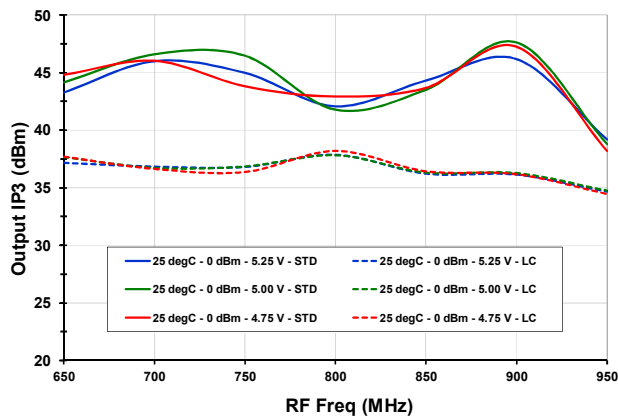
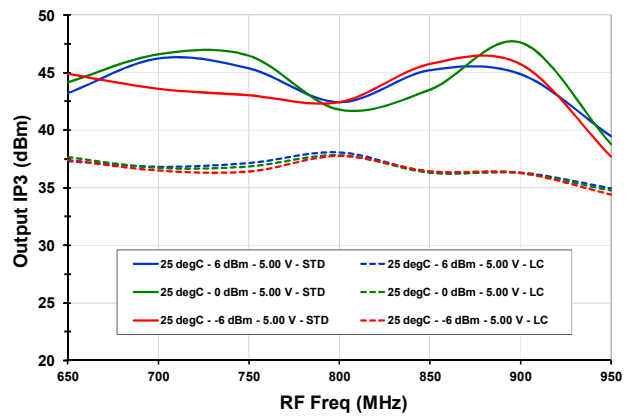
**TYPICAL OPERATING CONDITIONS [IF = 200 MHz, High Side Injection] (-1-)**
**Gain vs. T<sub>CASE</sub>**

**Gain vs. V<sub>CC</sub>**

**Gain vs. LO Level**

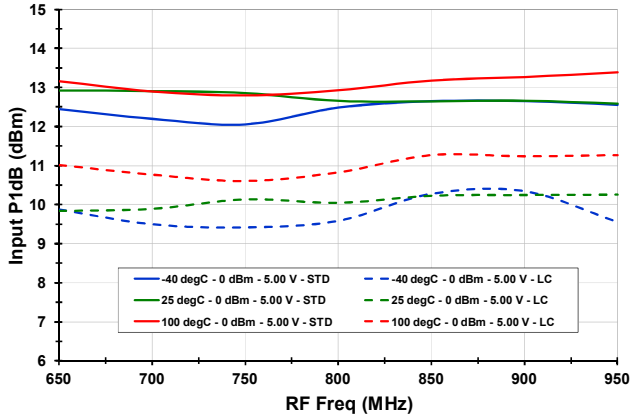
**Output IP3 vs. T<sub>CASE</sub>**

**Output IP3 vs. V<sub>CC</sub>**

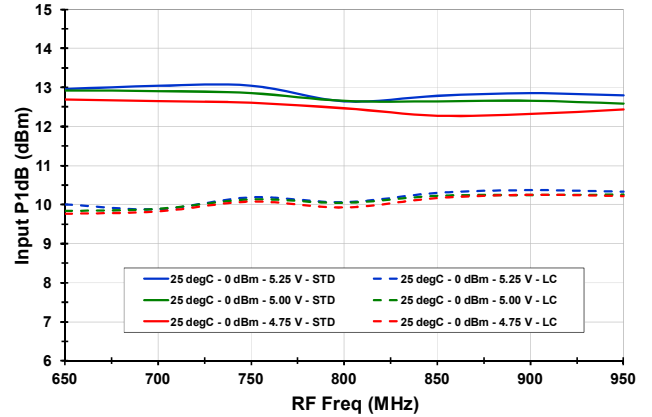
**Output IP3 vs. LO Level**

TYPICAL OPERATING CONDITIONS [IF = 200 MHz, High Side Injection] (-2-)

P1dB vs. T<sub>CASE</sub>



P1dB vs. V<sub>CC</sub>



P1dB vs. LO Level

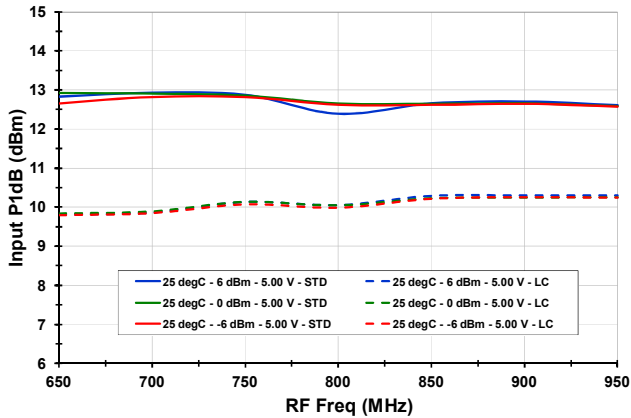

2RF x 2LO rejection vs. T<sub>CASE</sub>

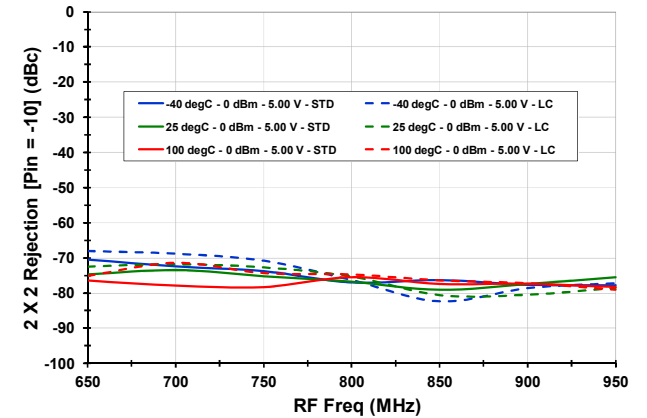

2RF x 2LO Rejection vs. V<sub>CC</sub>

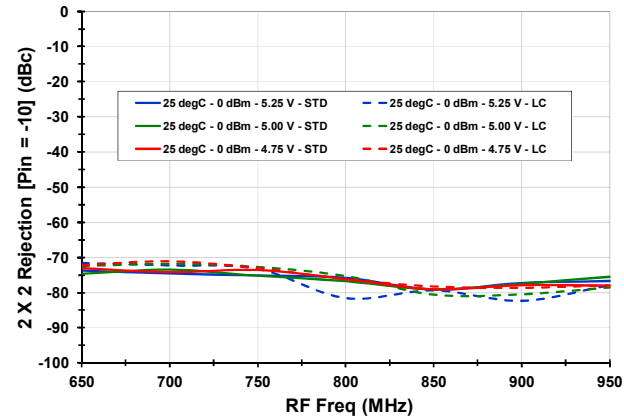

2RF x 2LO Rejection vs. LO Level

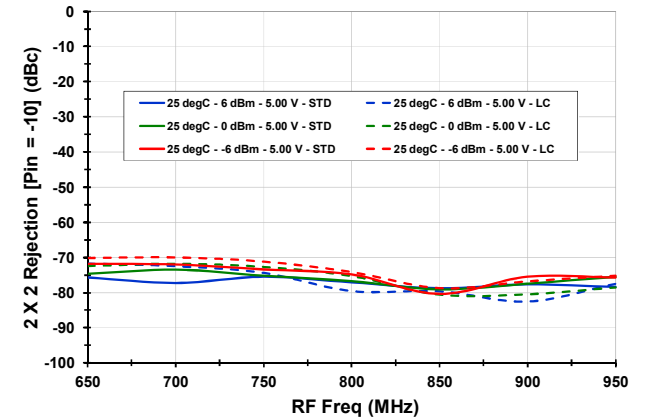

TYPICAL OPERATING CONDITIONS [IF = 200 MHz, High Side Injection] (-3-)

I<sub>CC</sub> vs. T<sub>CASE</sub>

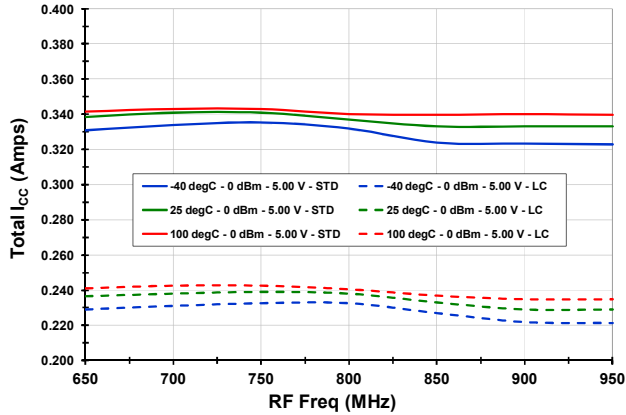

I<sub>CC</sub> vs. V<sub>CC</sub>

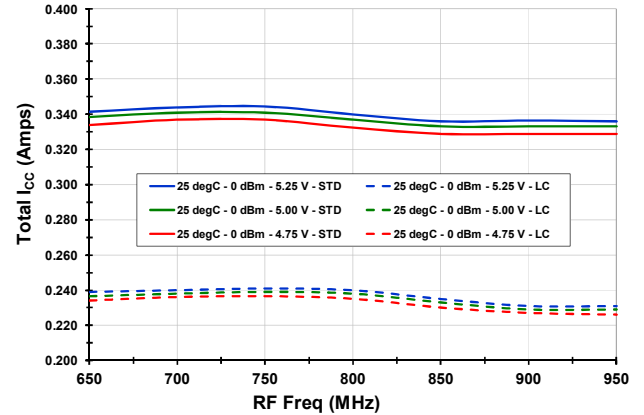

I<sub>CC</sub> vs. LO Level

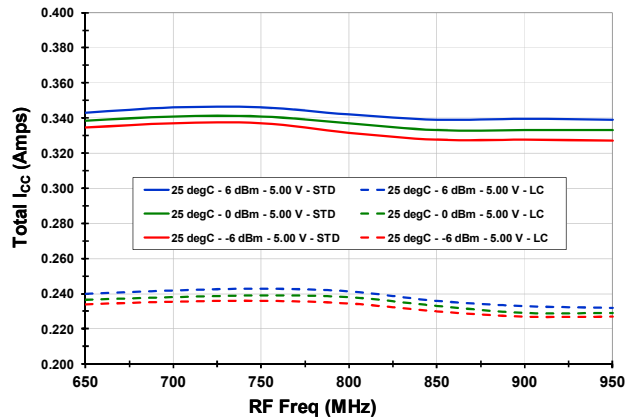

LO-IF Leakage vs. T<sub>CASE</sub>

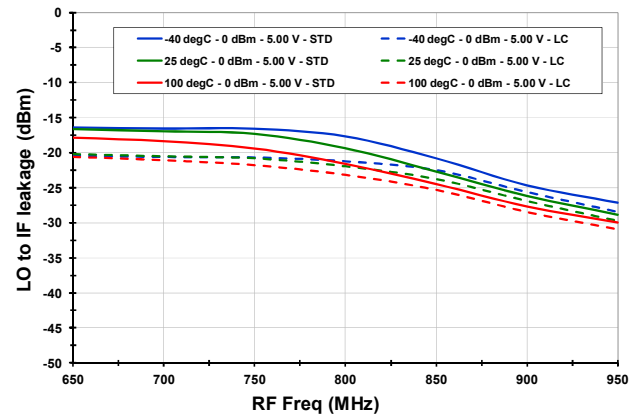

LO-IF Leakage vs. V<sub>CC</sub>

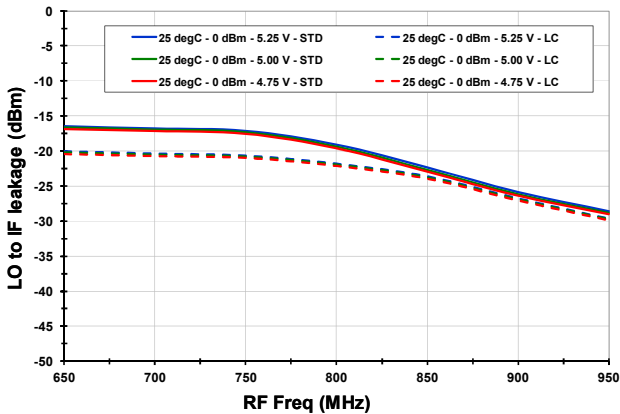

LO-IF Leakage vs. LO Level

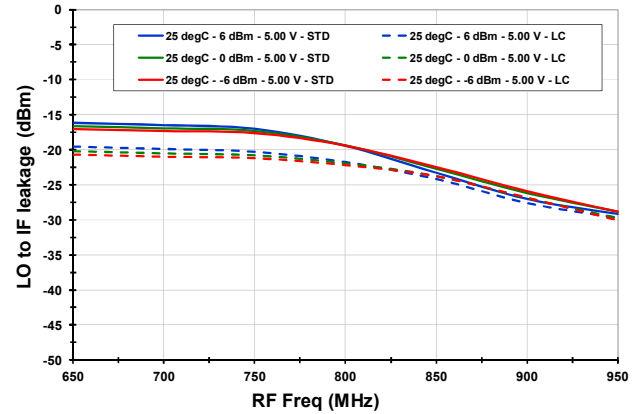



TYPICAL OPERATING CONDITIONS [IF = 200 MHz, High Side Injection] (-4-)

RF-IF Leakage vs. T<sub>CASE</sub>

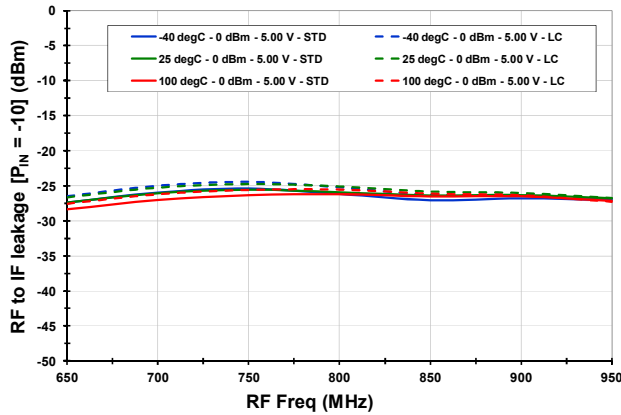

RF-IF Leakage vs. V<sub>CC</sub>

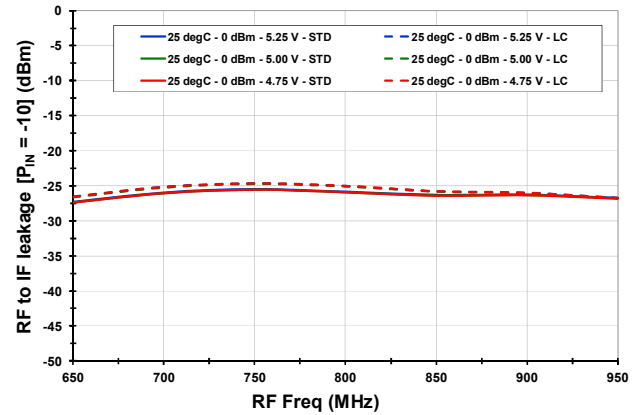

RF-IF Leakage vs. LO Level

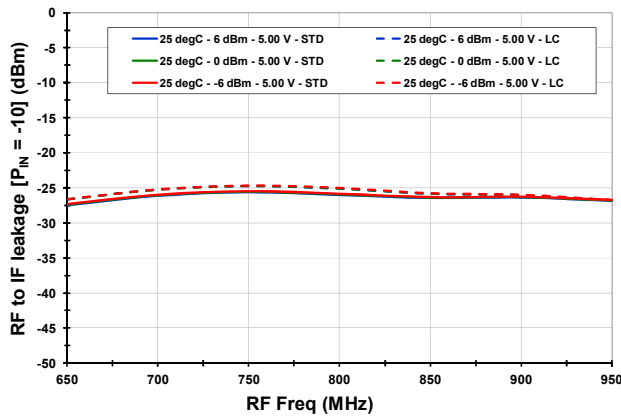

3RF X 3LO Rejection vs. T<sub>CASE</sub>

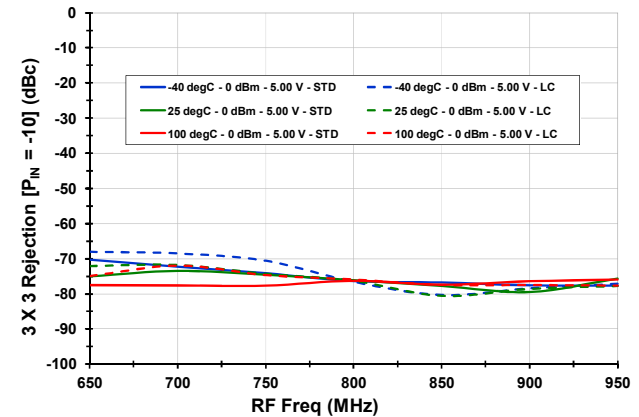

3RF X 3LO Rejection vs. V<sub>CC</sub>

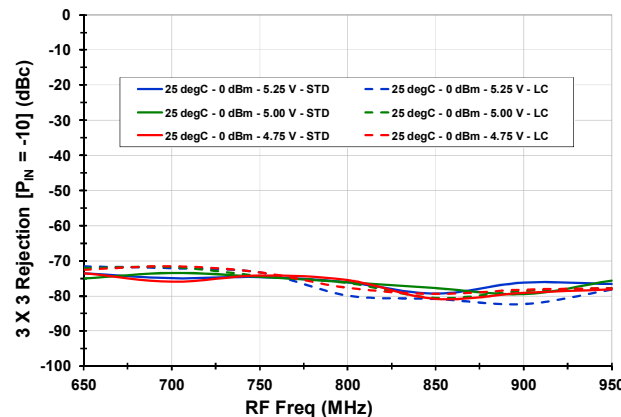

3RF X 3LO Rejection vs. LO Level

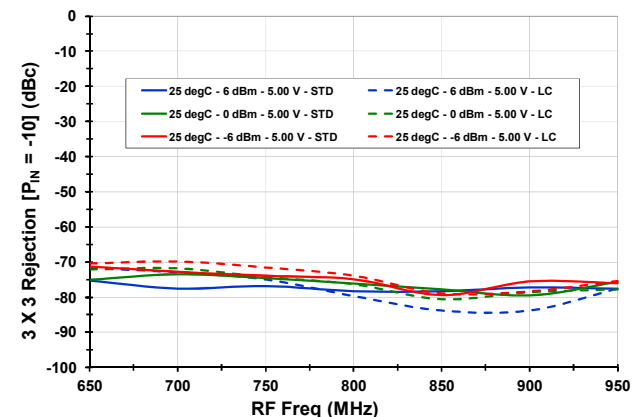

TYPICAL OPERATING CONDITIONS [IF = 200 MHz, High Side Injection] (-5-)

Channel Isolation vs. T<sub>CASE</sub>

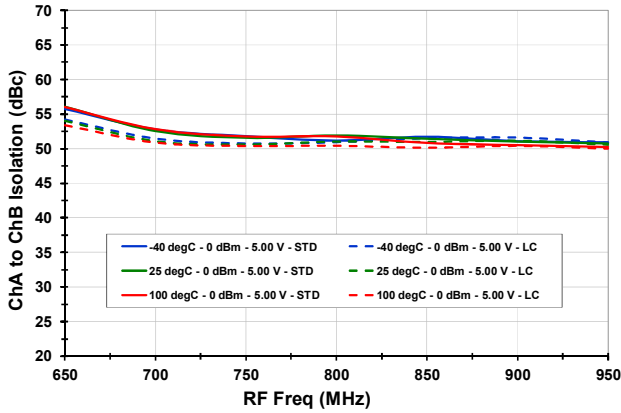

Channel Isolation vs. V<sub>CC</sub>

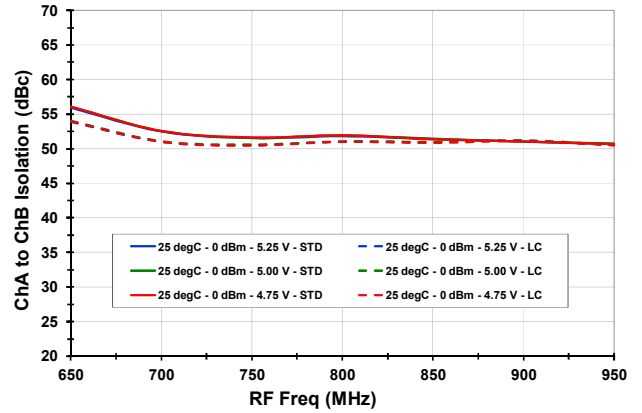

Channel Isolation vs. LO Level

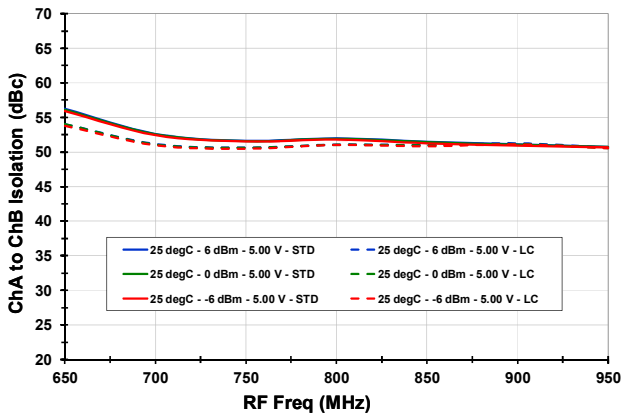

Noise Figure vs. T<sub>CASE</sub> (LC Mode)

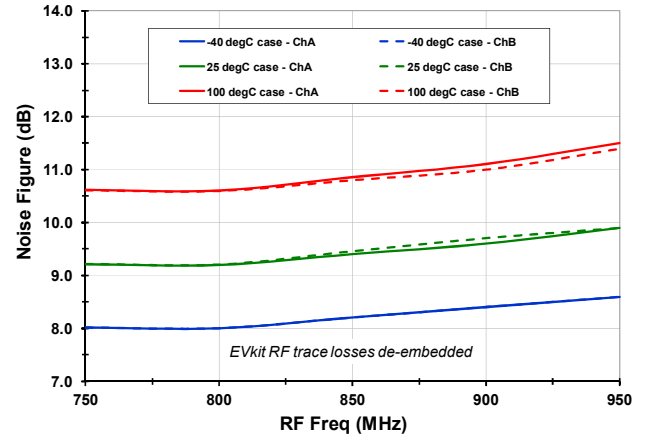

Noise Figure vs. T<sub>CASE</sub> (STD Mode)

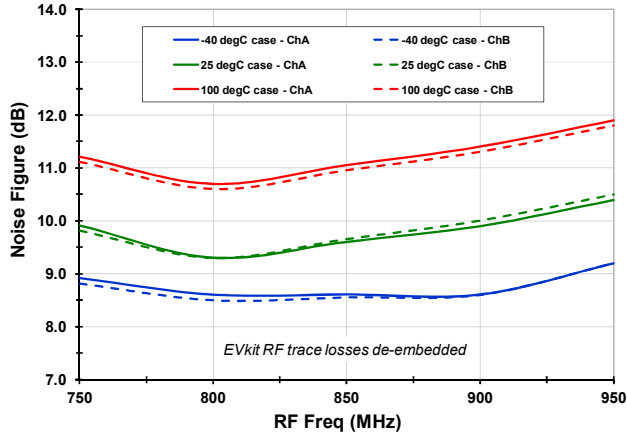

NF vs. Blocker (RF = 850 MHz, IF = 200 MHz, T<sub>A</sub> = 25C)

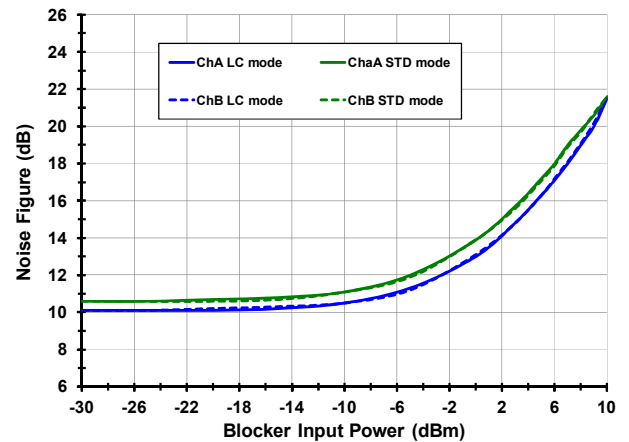

TYPICAL OPERATING CONDITIONS [IF = 150 MHz, Low Side Injection] (-6-)

Gain vs. T<sub>CASE</sub>

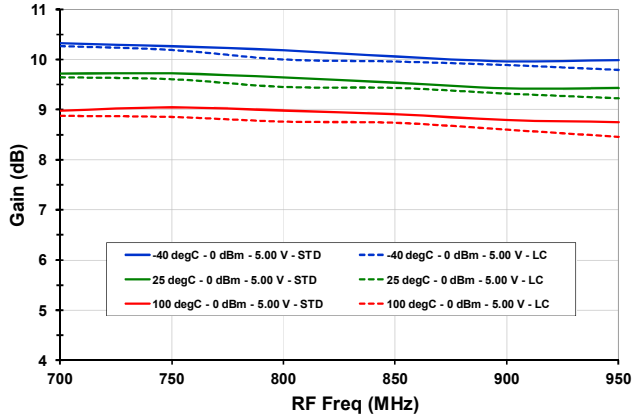

Gain vs. V<sub>CC</sub>

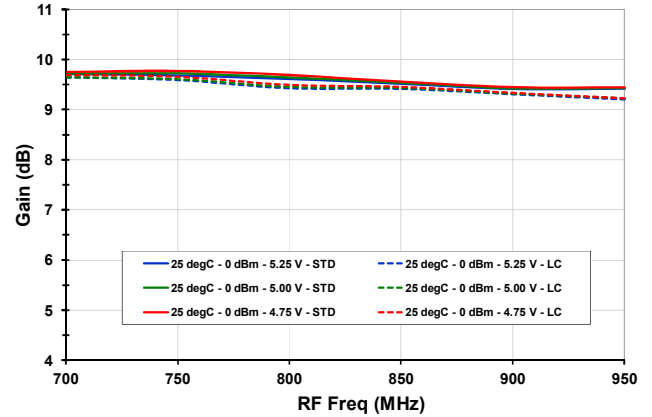

Gain vs. LO level

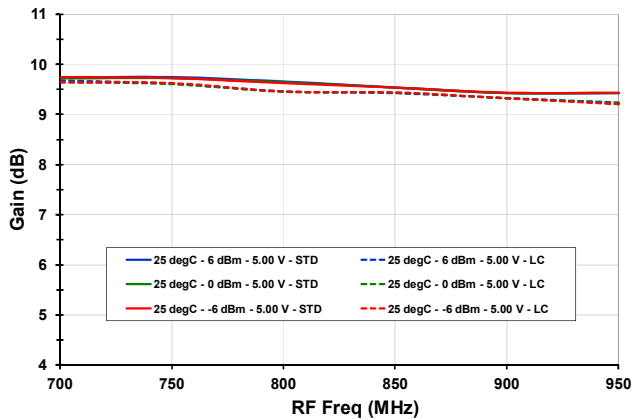

Output IP3 vs. T<sub>CASE</sub>

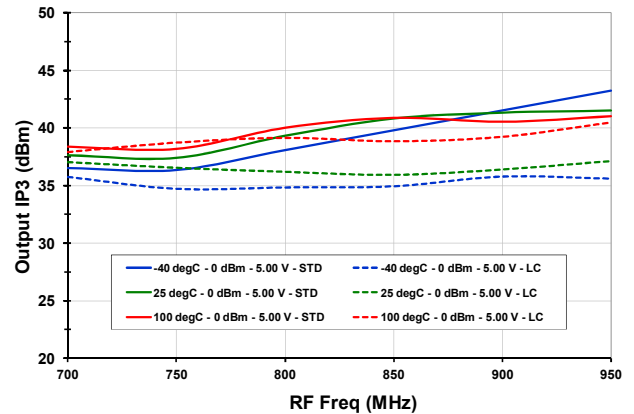

Output IP3 vs. V<sub>CC</sub>

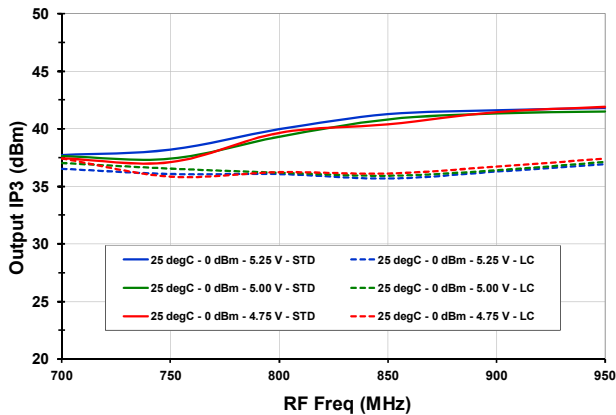

Output IP3 vs. LO Level

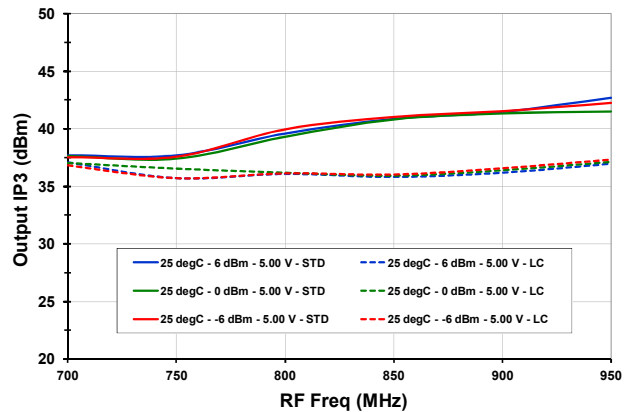

TYPICAL OPERATING CONDITIONS [IF = 150 MHz, Low Side Injection] (-7-)

P1dB vs. T<sub>CASE</sub>

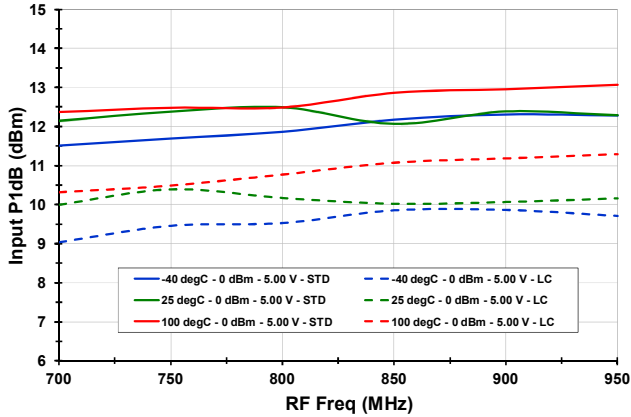

P1dB vs. V<sub>CC</sub>

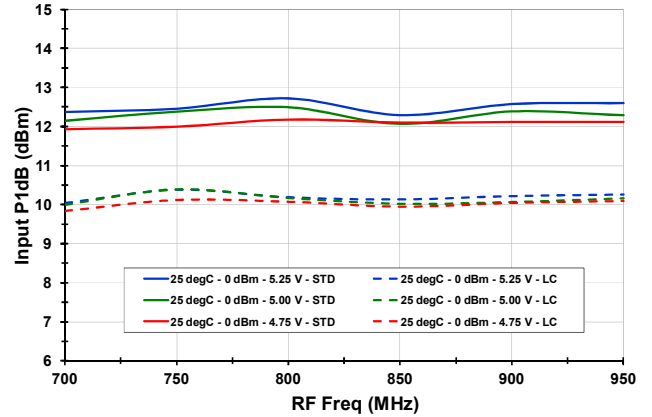

P1dB vs. LO Level

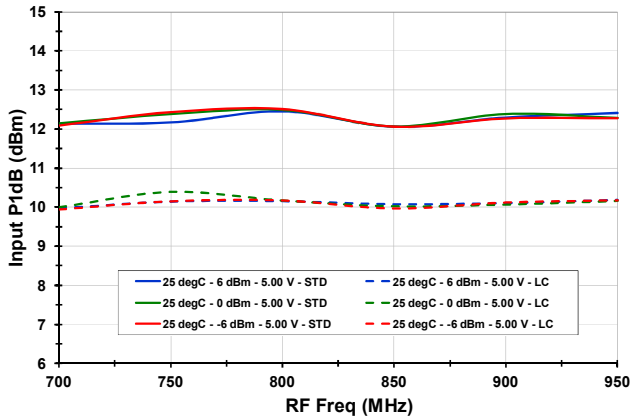

2RF x 2LO rejection vs. T<sub>CASE</sub>

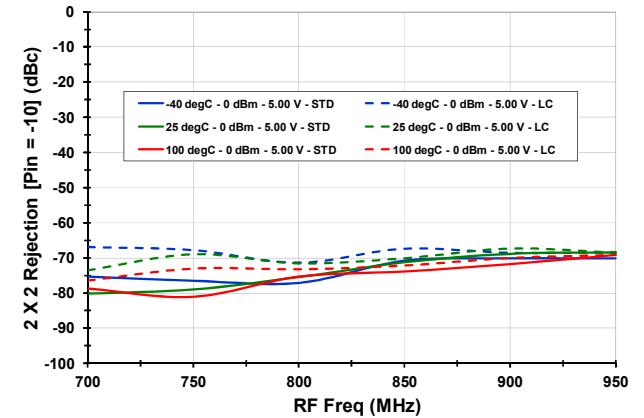

2RF x 2LO Rejection vs. V<sub>CC</sub>

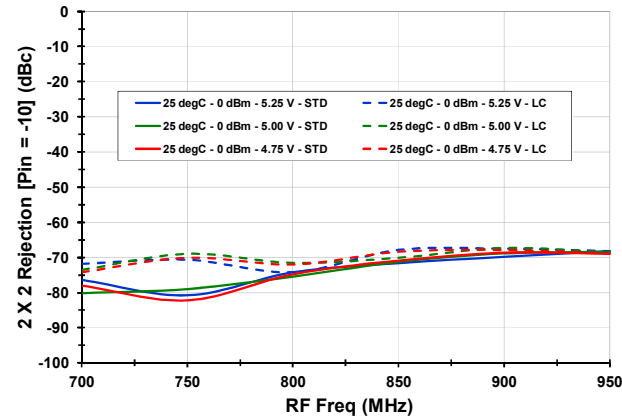

2RF x 2LO rejection vs. LO Level

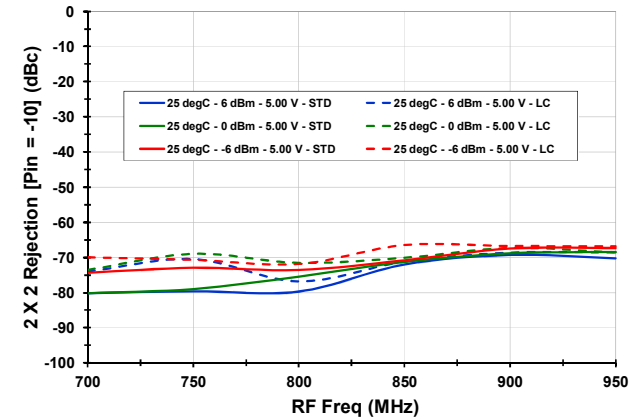

**TYPICAL OPERATING CONDITIONS [IF = 150 MHz, Low Side Injection] (-8-)**

**I<sub>CC</sub> vs. T<sub>CASE</sub>**

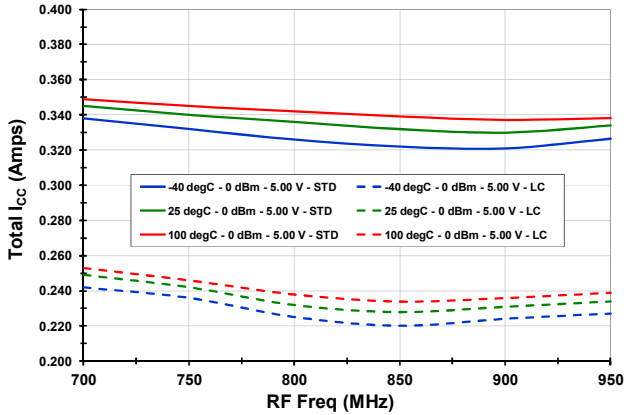

**I<sub>CC</sub> vs. V<sub>CC</sub>**

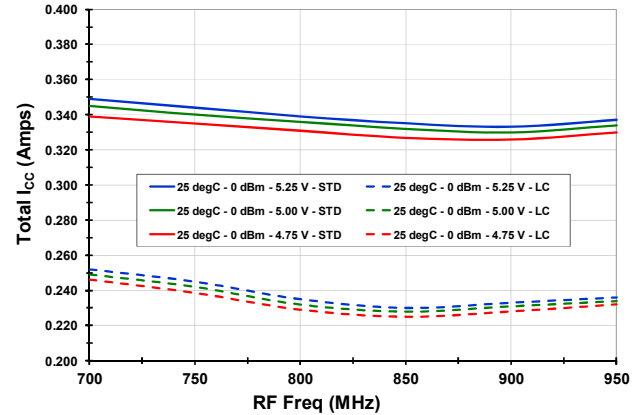

**I<sub>CC</sub> vs. LO Level**

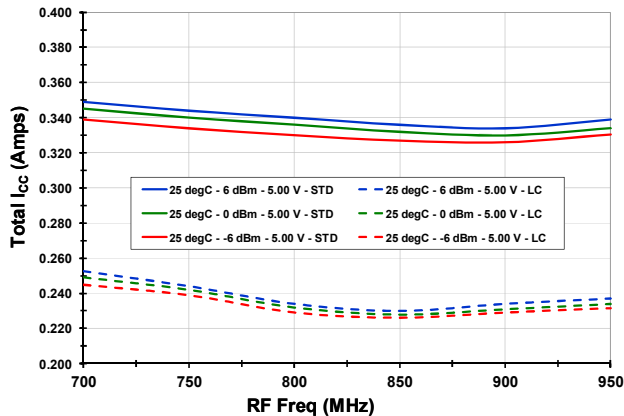

**LO-IF Leakage vs. T<sub>CASE</sub>**

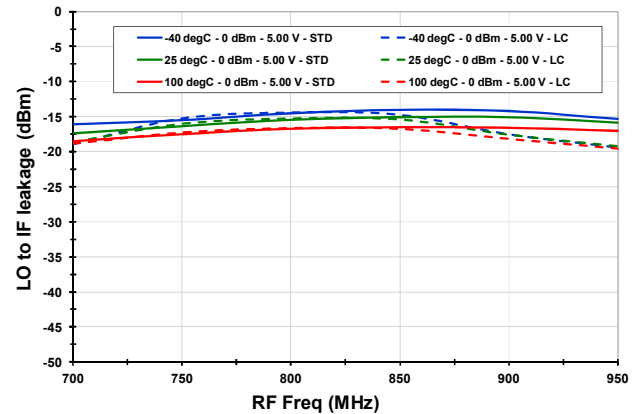

**LO-IF Leakage vs. V<sub>CC</sub>**

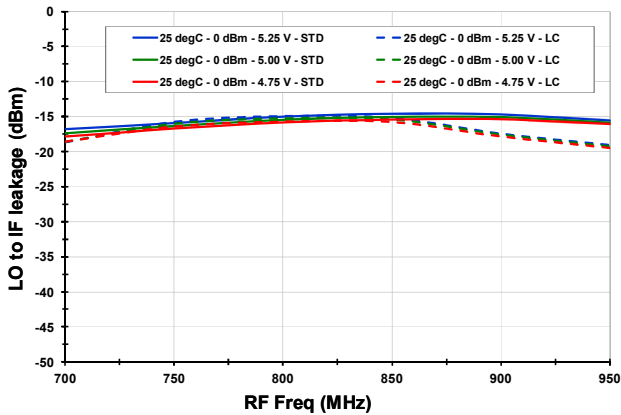

**LO-IF Leakage vs. LO Level**

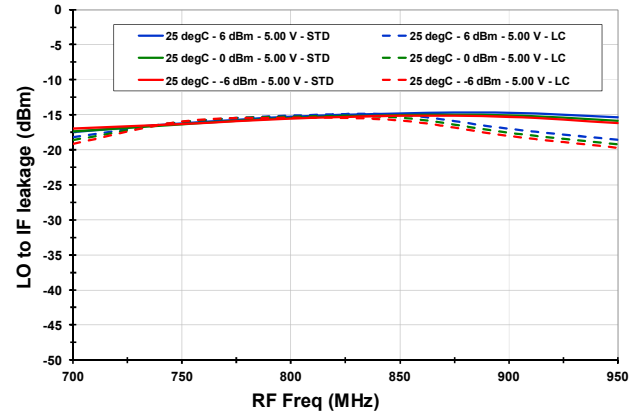

TYPICAL OPERATING CONDITIONS [IF = 150 MHz, Low Side Injection] (-9-)

RF-IF Leakage vs. T<sub>CASE</sub>

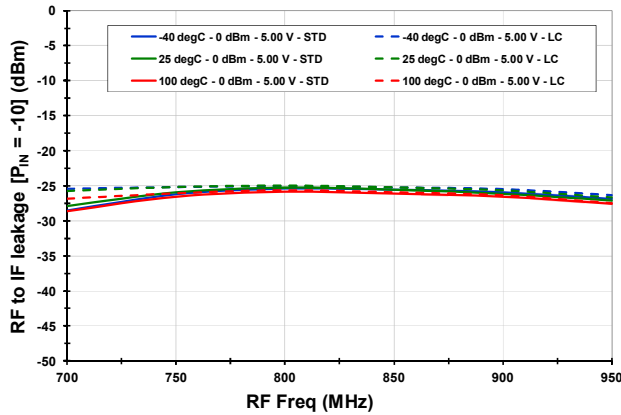

RF-IF Leakage vs. V<sub>CC</sub>

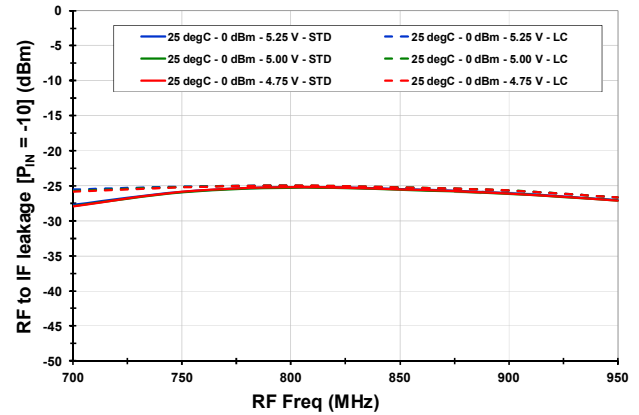

RF-IF Leakage vs. LO Level

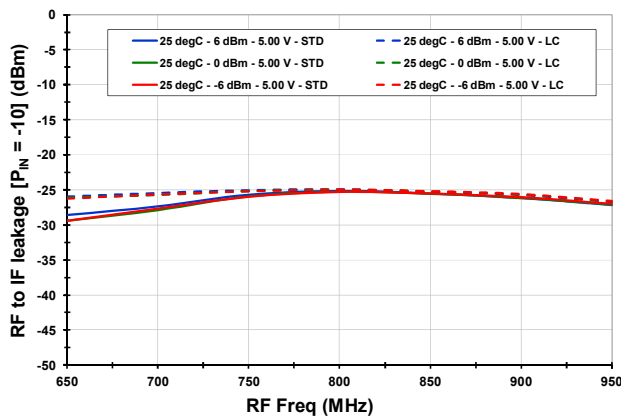

3RF X 3LO Rejection vs. T<sub>CASE</sub>

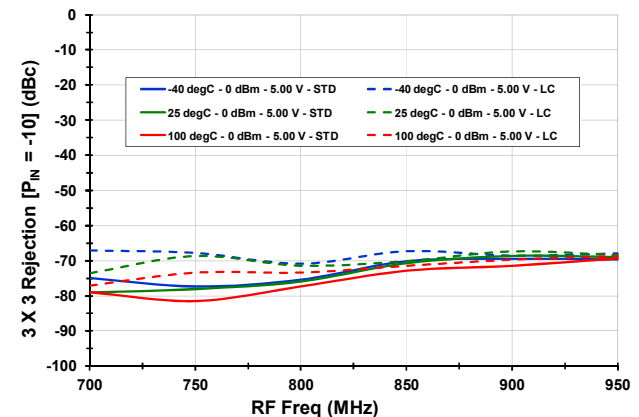

3RF X 3LO Rejection vs. V<sub>CC</sub>

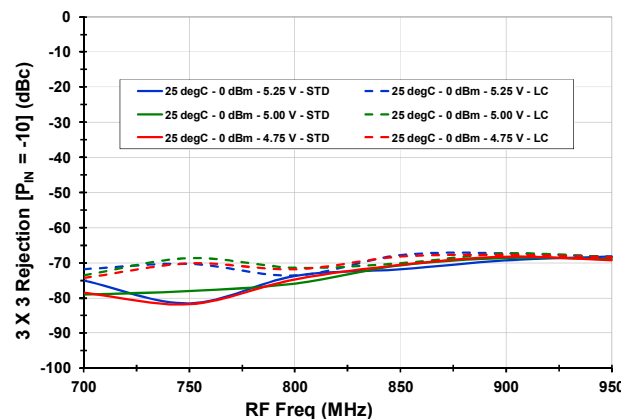

3RF X 3LO Rejection vs. LO Level

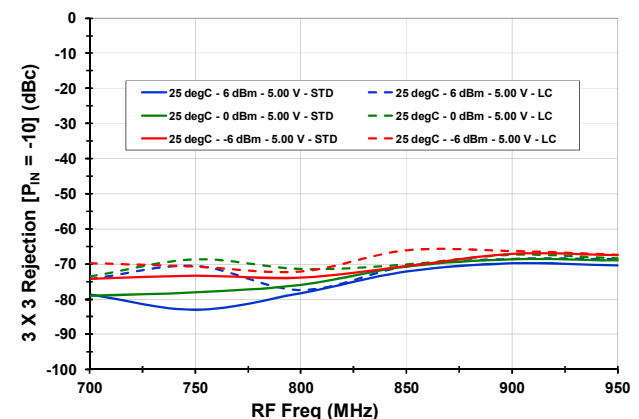

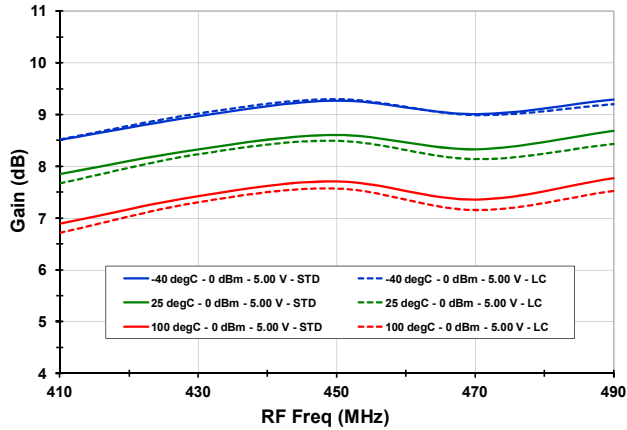
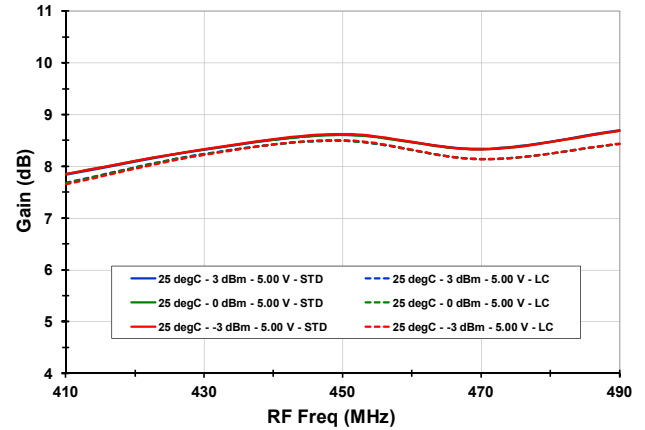
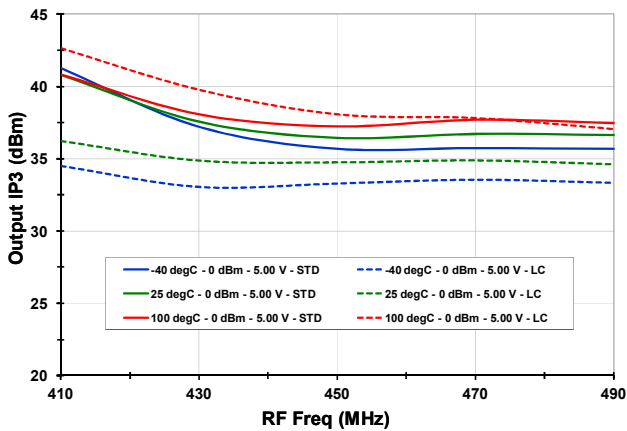
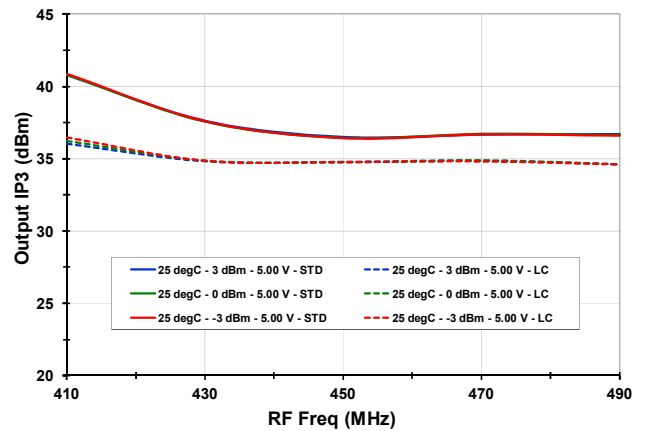
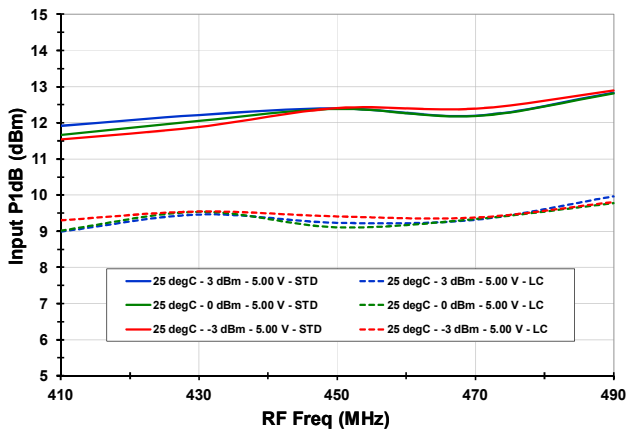
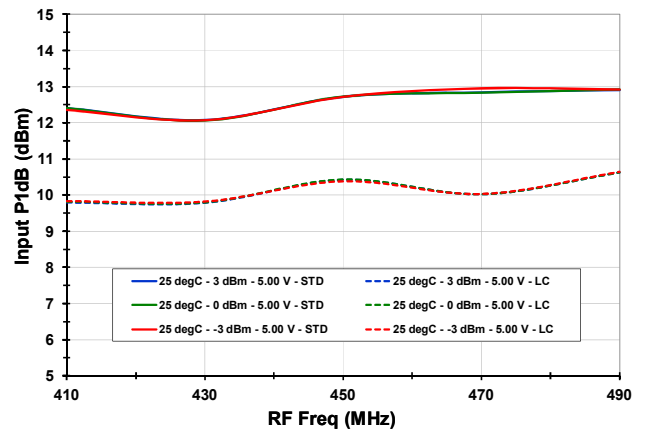
**TYPICAL OPERATING CONDITIONS [400 MHz Bands see modifications on p. 25] (-10-)**
**Gain vs. T<sub>CASE</sub> (130 MHz IF)**

**Gain vs. LO Level (130 MHz IF)**

**Output IP3 vs. T<sub>CASE</sub> (130 MHz IF)**

**Output IP3 vs. LO Level (130 MHz IF)**

**P1dB vs. LO Level (70 MHz IF)**

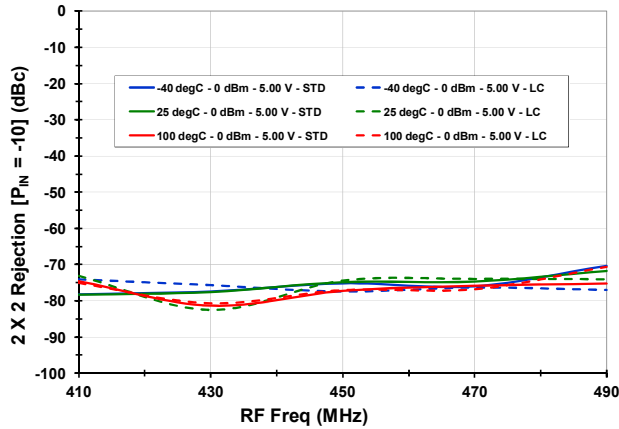
**P1dB vs. LO Level (130 MHz IF)**

RF to IF Dual Downconverting Mixer

400 – 1000 MHz F1102NBGI

TYPICAL OPERATING CONDITIONS [400 MHz Bands see modifications on p. 25] (-11-)

2RF x 2LO vs. T<sub>CASE</sub> (130 MHz IF)



2RF x 2LO vs. LO Level (130 MHz IF)

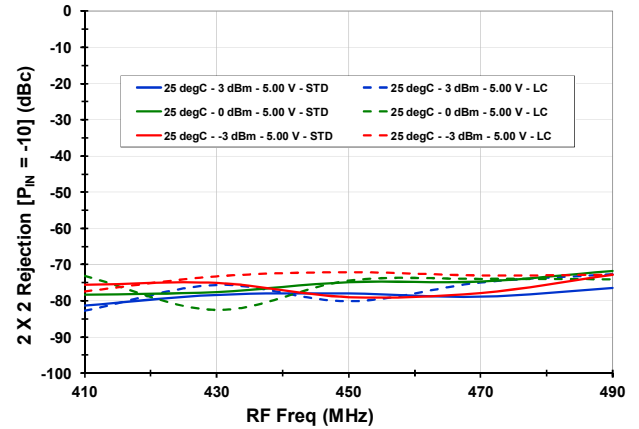

I<sub>CC</sub> vs. T<sub>CASE</sub> (130 MHz IF)

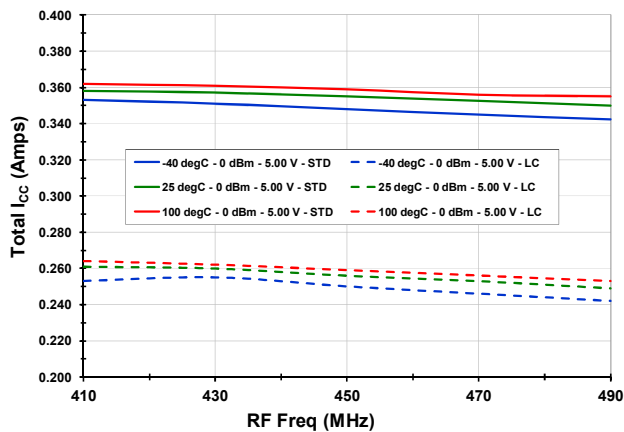

I<sub>CC</sub> vs. LO Level (130 MHz IF)

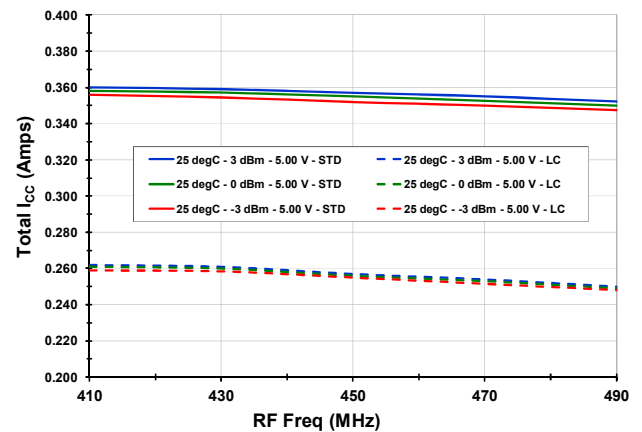

LO to IF Leakage vs. T<sub>CASE</sub> (130 MHz IF)

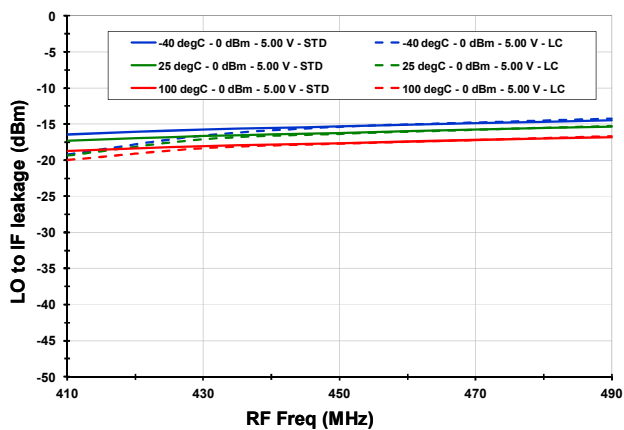

LO to IF Leakage vs. LO Level (130 MHz IF)

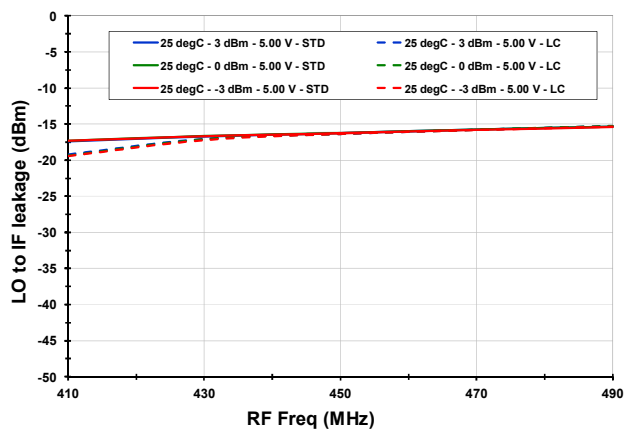



TYPICAL OPERATING CONDITIONS [400 MHz Bands see modifications on p. 25] (-12-)

RF to IF Leakage vs. T<sub>CASE</sub> (130 MHz IF)

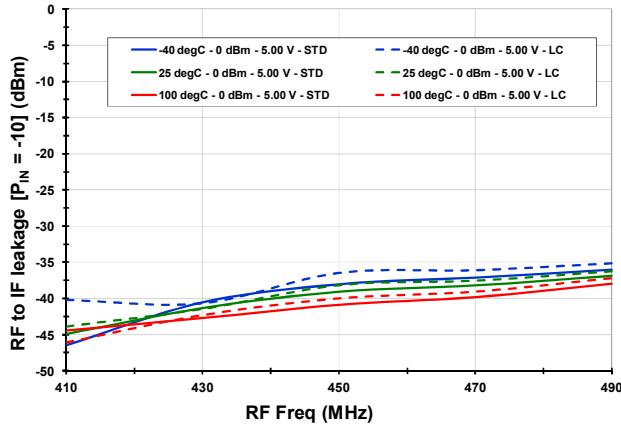

RF to IF Leakage vs. LO Level (130 MHz IF)

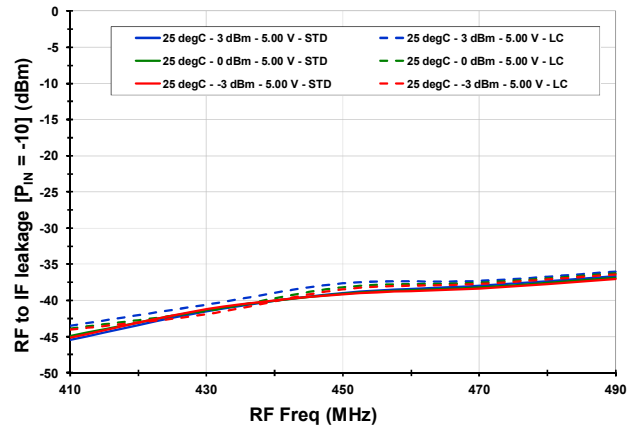

3RF x 3LO rejection vs. T<sub>CASE</sub> (130 MHz IF)

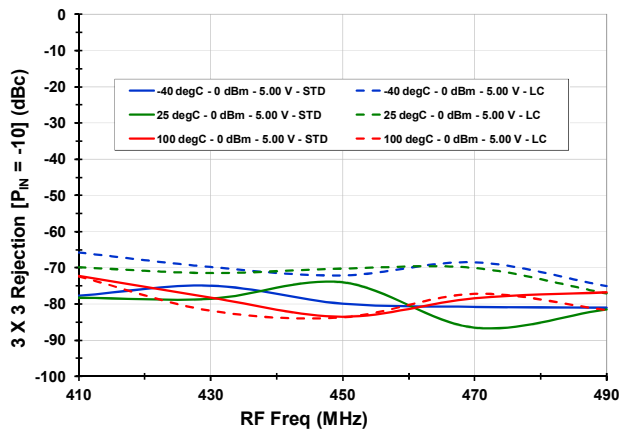

3RF x 3LO rejection vs. LO Level (130 MHz IF)

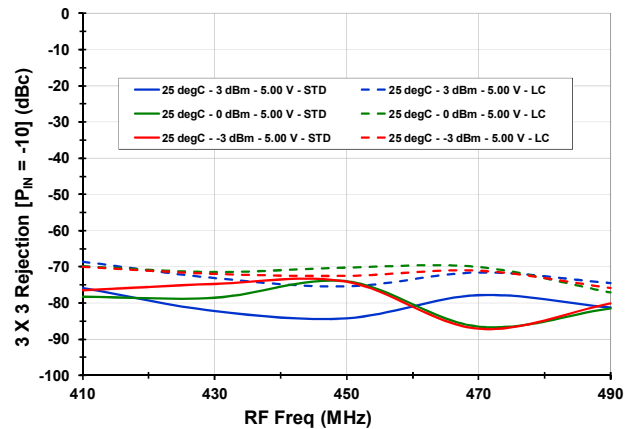

Channel Isolation vs. LO level (130 MHz IF)

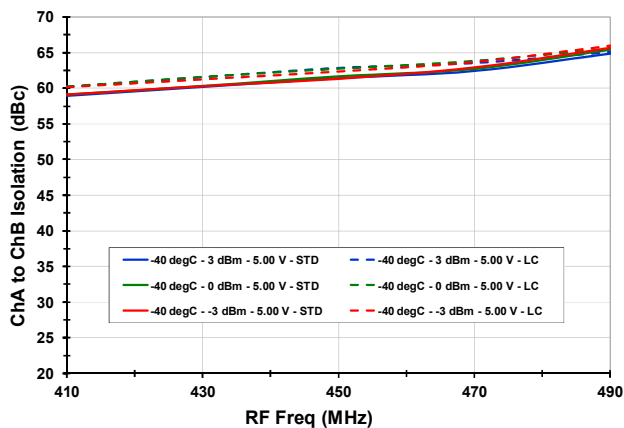

Noise Figure (T<sub>CASE</sub> = 25C)

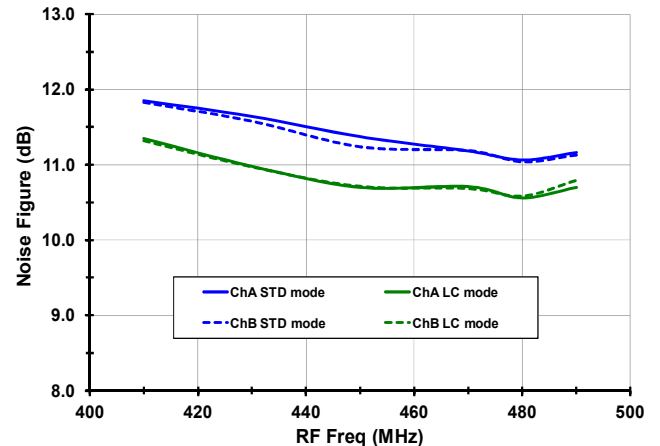

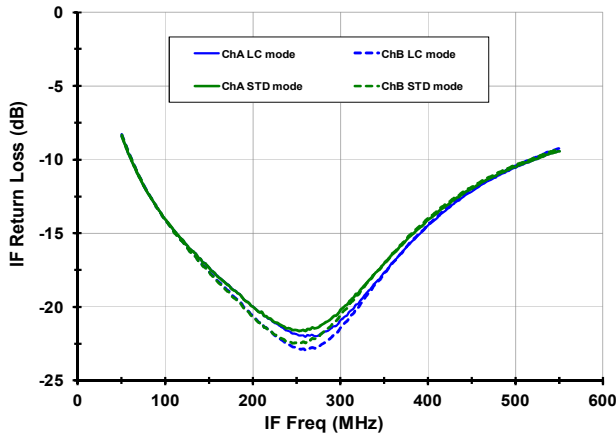
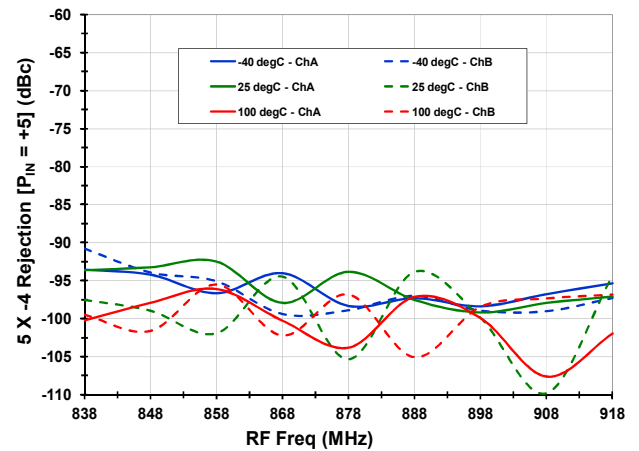
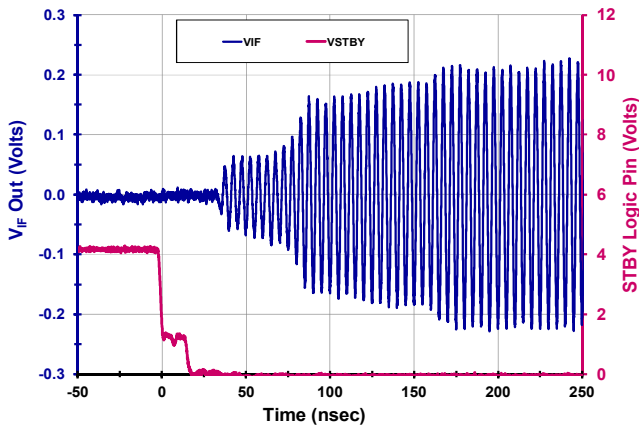
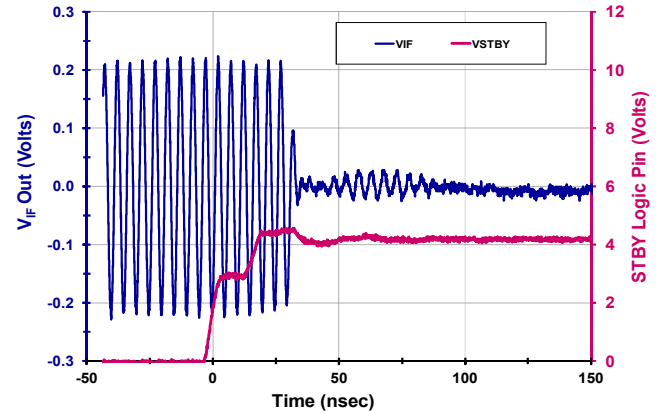
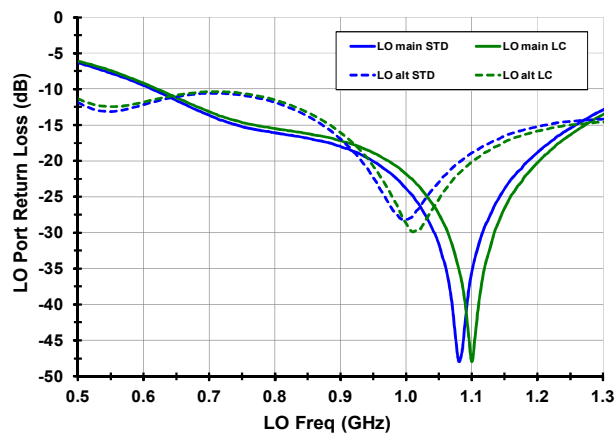
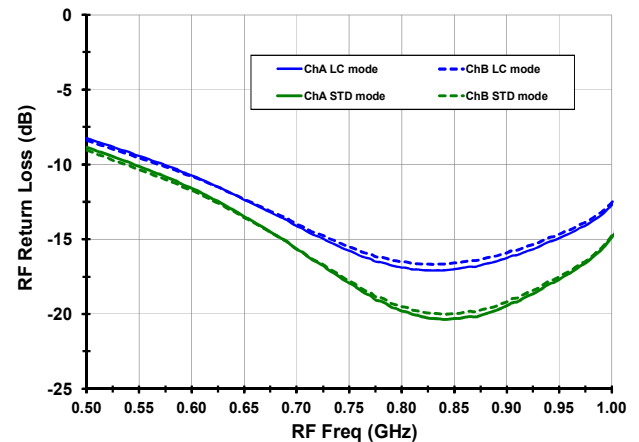
**TYPICAL OPERATING CONDITIONS [General] (-13-)**
**EVkit IF Port Match ( $T_A = 25C$ )**

**SRF X -4LO Rejection (IF = 190M, STD Mode)**

**Settling Time (STBY ->  $V_{IL}$ )**

**Settling Time (STBY ->  $V_{IH}$ )**

**EVkit LO Port Match ( $T_A = 25C, P_{MEAS} = 0 \text{ dBm}$ )**

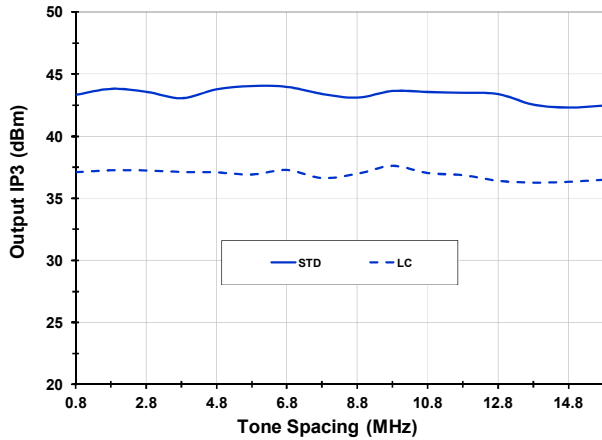
**EVkit RF Port Match ( $T_A = 25C$ )**

RF to IF Dual Downconverting Mixer

400 – 1000 MHz F1102NBGI

TYPICAL OPERATING CONDITIONS [General] (-14-)

IP3<sub>O</sub> vs. Δf (T<sub>A</sub> = 25C, Freq = 850 MHz, IF = 200 MHz)



IP3<sub>O</sub> vs. P<sub>IN</sub> (T<sub>A</sub> = 25C, Freq = 850 MHz, IF = 200 MHz)

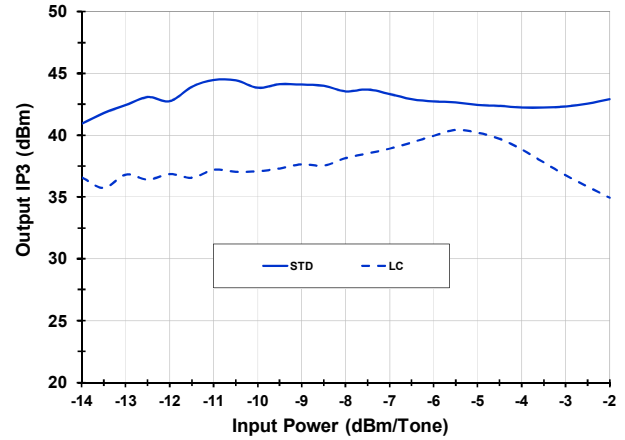

EVkit Input RF Trace Loss (T<sub>A</sub> = 25C)

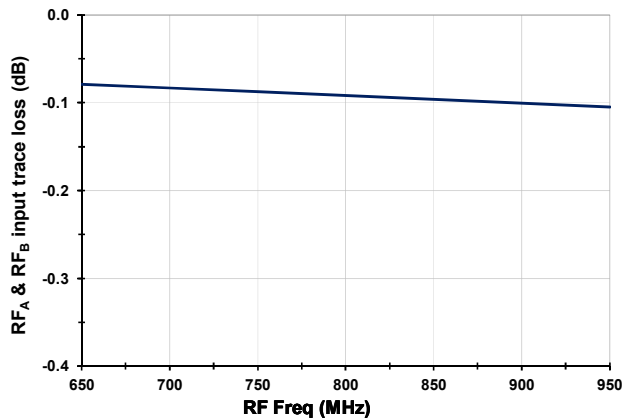

TC4-1T Transformer Loss

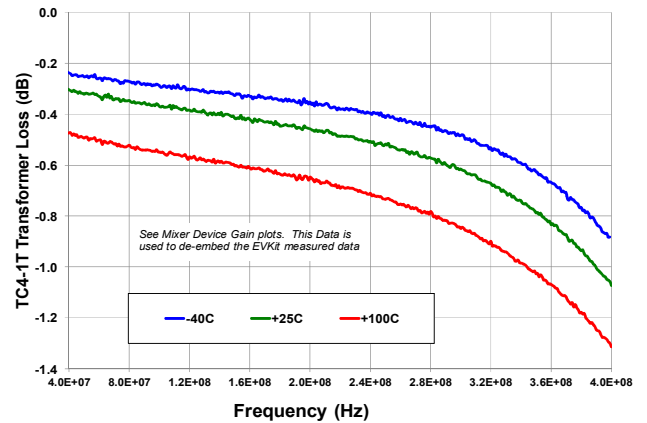

IP3<sub>O</sub> Distribution (F<sub>RF</sub> = 850 MHz, LC mode, N = 1598)

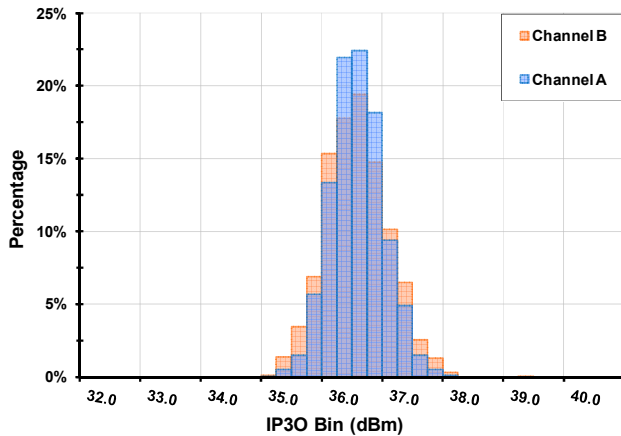

Gain Distribution (F<sub>RF</sub> = 915 MHz, LC mode, N = 1598)

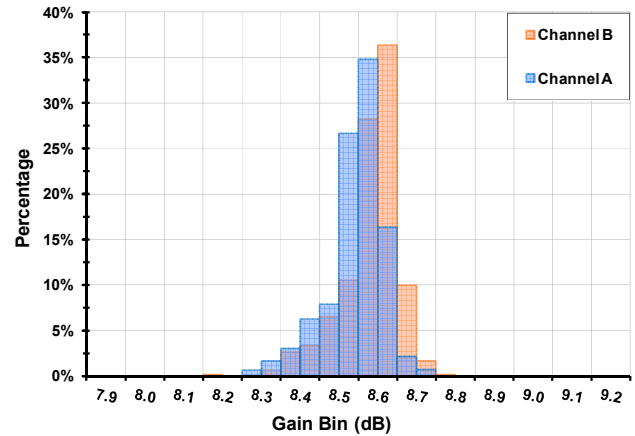



**PINOUTS**

Black Text denotes recommended external connection

Red Text denotes internal Function or Connection

- DB GND = Downbonded to Paddle
- Internal NC = Pin not connected

**Please Note!**

- Only connect to one LO feed
- Choose Either Pin 19 or Pin 27
- Do not connect the unused LO pin to ensure good LO return loss

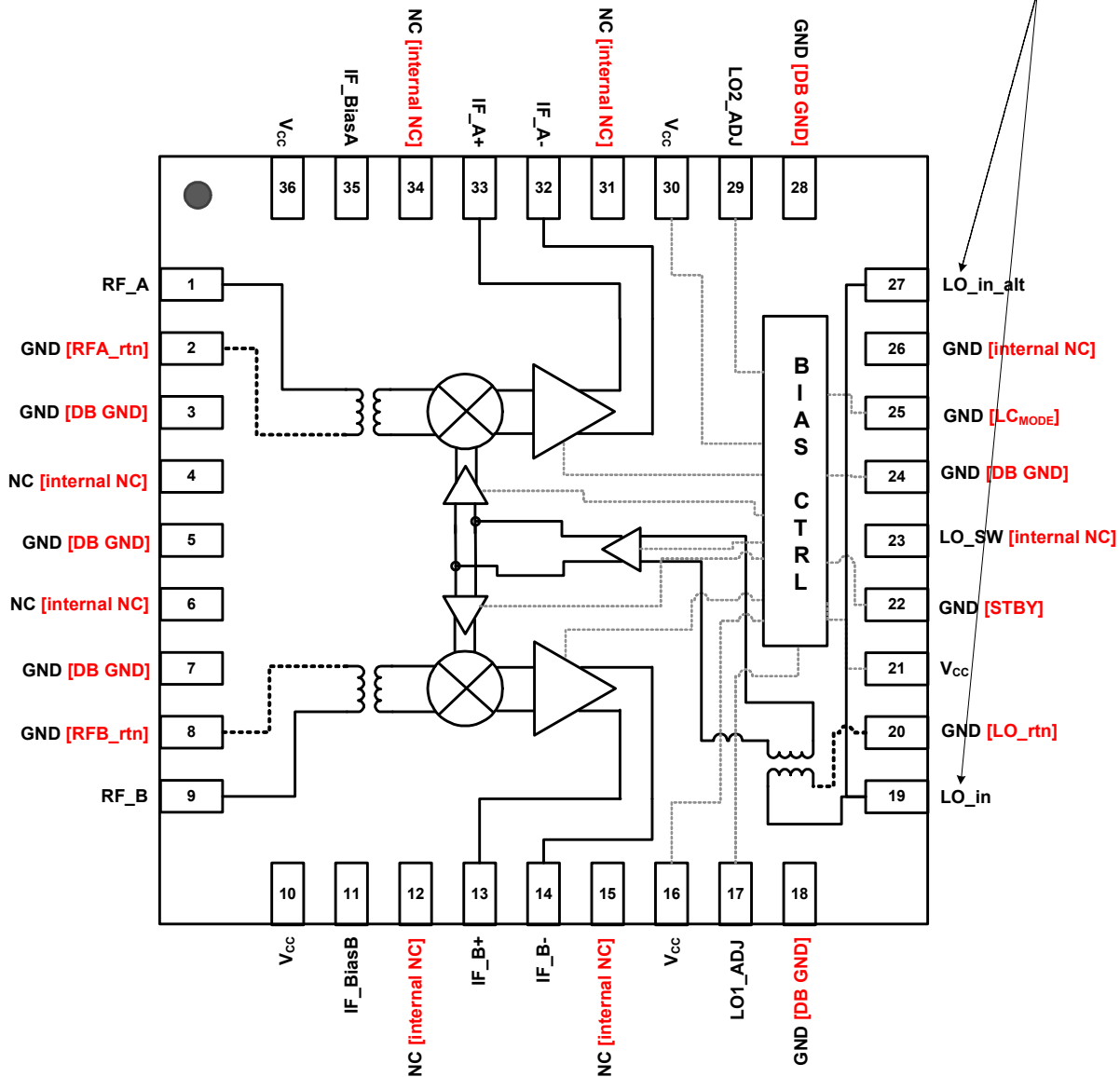

**PIN DESCRIPTIONS**

| Pin                             | Name                        | Function   |
|---------------------------------|-----------------------------|--|
| 1                               | RF_A                        | Main Channel RF Input. Internally matched to 50Ω. DO NOT apply DC to these pins  |
| 2, 8, 20                        | RF_Artn,<br>RF_Brtn, LO_rtn | Transformer Ground Returns. Ground these pins.   |
| 3, 5, 7, 18, 24,<br>28          | GND                         | Ground these pins.   |
| 4, 6, 12, 15,<br>31, 23, 26, 34 | N.C.                        | No Connection. Not internally connected. OK to connect to Vcc. OK to connect to GND  |
| 10, 16, 21, 30,<br>36           | VCC                         | Power Supply. Bypass to GND with capacitors shown in the Typical Application Circuit as close as possible to pin.  |
| 9                               | RF_B                        | Diversity Channel RF Input. Internally matched to 50Ω  |
| 11                              | IF_BiasB                    | Connect the specified resistor from this pin to ground to set the bias for the Diversity IF amplifier. This is NOT a current set resistor  |
| 13, 14                          | IFB+, IFB-                  | Diversity Mixer Differential IF Output. Connect pullup inductors from each of these pins to VCC (see the Typical Application Circuit).   |
| 17                              | LO1_ADJ                     | Connect the specified resistor for either Standard or LC mode from this pin to ground to set the LO common buffer Icc  |
| 19, 27                          | LO_in<br>LO_in_alt          | Local Oscillator Input. Connect the LO to this port through the recommended coupling capacitor. <b>Note that you can only drive one LO port at a time. Remove the series capacitor from the unused port.</b>   |
| 25                              | LC_MODE                     | Low_Current Mode. Set this pin to low or ground for LC mode. Set to high or No-Connect for Standard mode. There is an internal pull-up resistor.   |
| 22                              | STBY                        | STBY Mode. Pull this pin high for Standby mode (~20 mA). Pull low or Ground for normal Operation   |
| 29                              | LO2_ADJ                     | Connect the specified resistor for either Standard or LC mode from this pin to ground to set the LO drive buffers Icc  |
| 32, 33                          | IFA-, IFA+                  | Main Mixer Differential IF Output. Connect pullup inductors from each of these pins to VCC (see the Typical Application Circuit).  |
| 35                              | IF_BiasA                    | Connect the specified resistor from this pin to ground to set the bias for the Main IF amplifier. This is NOT a current set resistor   |
|                                 | — EP                        | Exposed Pad. Internally connected to GND. Solder this exposed pad to a PCB pad that uses multiple ground vias to provide heat transfer out of the device into the PCB ground planes. These multiple via grounds are also required to achieve the noted RF performance. |
|                                 |                             |  |

EVKIT SCHEMATIC

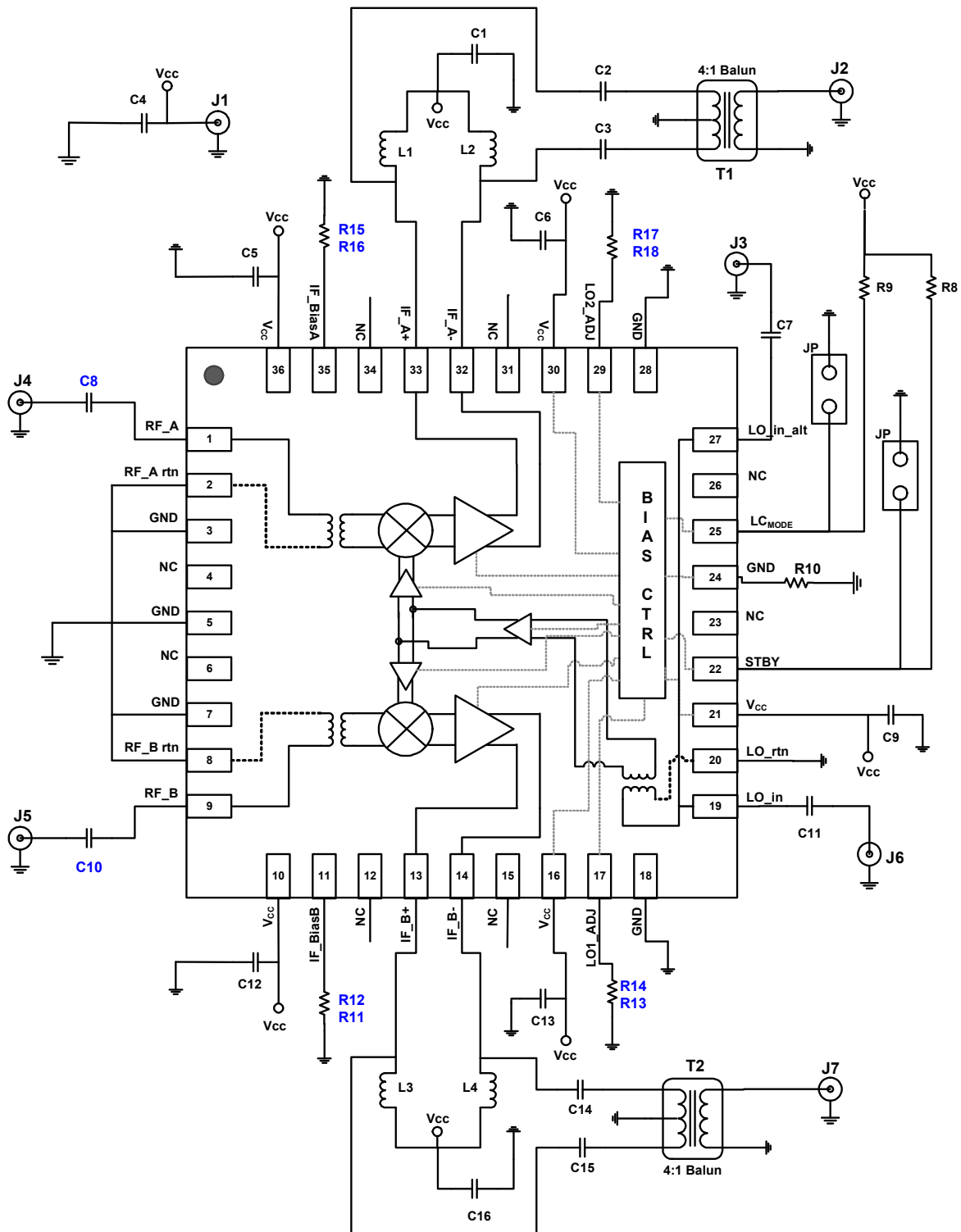



**EVKIT PICTURE/LAYOUT/OPERATION**

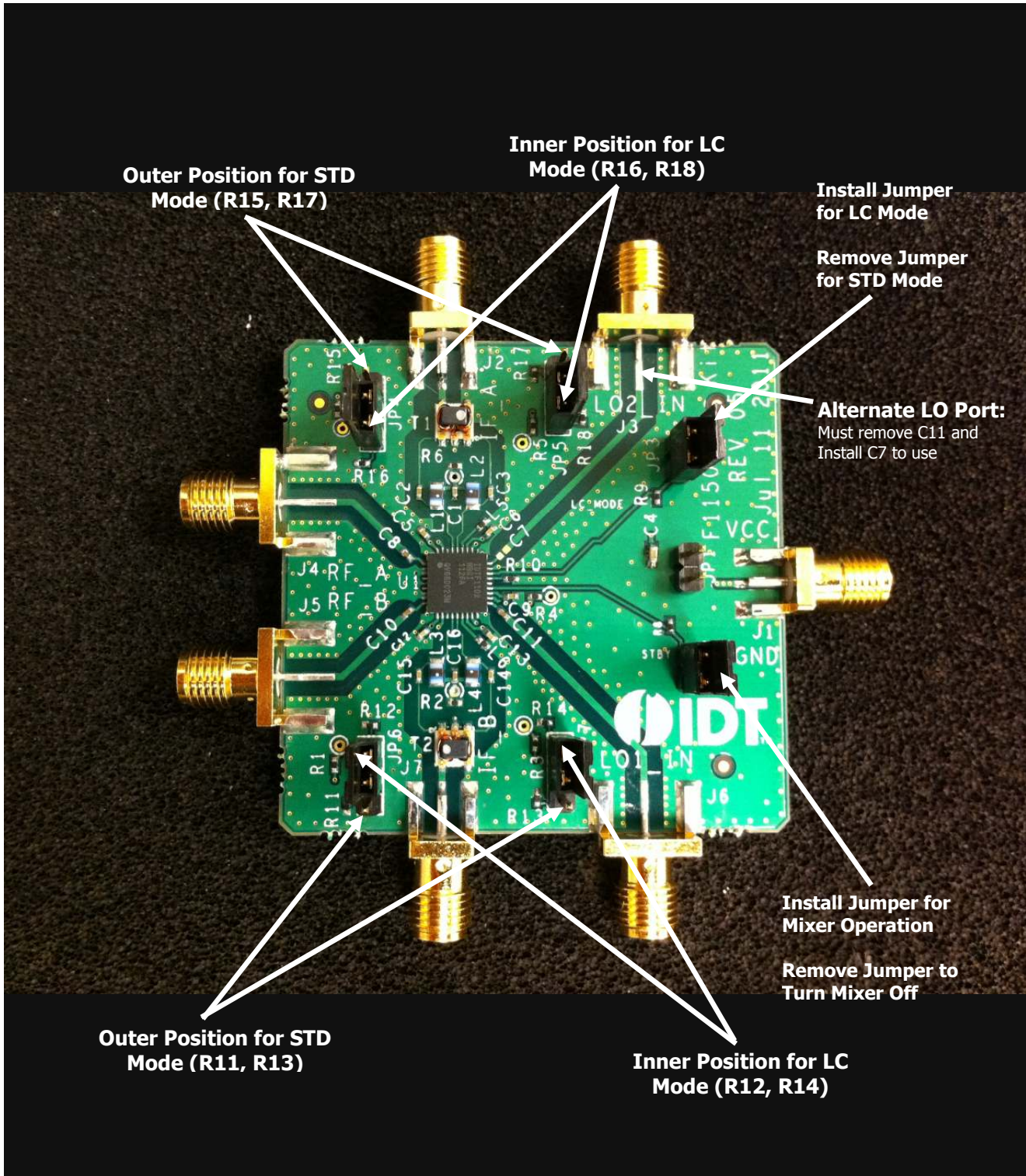



**EVKIT BOM**
**Default BOM:**

For Standard Mode, Open the LC<sub>MODE</sub> jumper in conjunction with positioning the 4 dual jumpers to select the resistors in **red**.

For Low Current Mode close the LC<sub>MODE</sub> jumper in conjunction with positioning the 4 dual jumpers to select the resistors in **blue**.

**F1102 BOM**

| Item # | Value          | Size   | Desc   | Mfr. Part #        | Mfr.            | Part Reference    | Qty |
|--------|----------------|--------|--|--------------------|-----------------|-------------------|-----|
| 1      | 10nF           | 0402   | CAP CER 10000PF 16V 10% X7R 0402   | GRM155R71C103KA01D | MURATA          | C1,5,6,9,12,13,16 | 7   |
| 2      | 1000pF         | 0402   | CAP CER 1000PF 50V C0G 0402  | GRM1555C1H102JA01D | MURATA          | C2,3,14,15        | 4   |
| 3      | 150pF          | 0402   | CAP CER 150PF 50V C0G 0402   | GRM1555C1H151JA01D | MURATA          | C8,10,11          | 3   |
| 4      | 9 pF           | 0402   | Note: C7 and C11 cannot be installed together. C7 for Pin27 LO feed. C11 for Pin19 LO feed |                    |                 | C7                | 1   |
| 5      | 10uF           | 0603   | CAP CER 10UF 6.3V X5R 0603   | GRM188R60J106ME47D | MURATA          | C4                | 1   |
| 6      | Header 2 Pin   | TH 2   | CONN HEADER VERT SGL 2POS GOLD   | 961102-6404-AR     | 3M              | JP1,2,3           | 3   |
| 7      | Header 3 Pin   | TH 3   | CONN HEADER VERT SGL 3POS GOLD   | 961103-6404-AR     | 3M              | JP4,5,6,7         | 4   |
| 8      | SMA_END_LAUNCH | .062   | SMA_END_LAUNCH (Small)   | 142-0711-821       | Emerson Johnson | J1,2,7            | 3   |
| 9      | SMA_END_LAUNCH | .062   | SMA_END_LAUNCH (Big)   | 142-0701-851       | Emerson Johnson | J3,4,5,6          | 4   |
| 10     | 270nH          | 0805   | 0805CS (2012) Ceramic Chip Inductor  | 0805CS-271XJLB     | COILCRAFT       | L1,2,3,4          | 4   |
| 11     | 27             | 0402   | RES 27 OHM 1/10W 1% 0402 SMD   | ERJ-2RKF27R0X      | Panasonic       | R11,15            | 2   |
| 12     | 62             | 0402   | RES 62.0 OHM 1/10W 1% 0402 SMD   | ERJ-2RKF62R0X      | Panasonic       | R12,16            | 2   |
| 13     | 91             | 0402   | RES 91.0 OHM 1/10W 1% 0402 SMD   | ERJ-2RKF91R0X      | Panasonic       | R13               | 1   |
| 14     | 180            | 0402   | RES 180 OHM 1/10W 1% 0402 SMD  | ERJ-2RKF1800X      | Panasonic       | R14               | 1   |
| 15     | 1.91K          | 0402   | RES 1.91K OHM 1/10W 1% 0402 SMD  | ERJ-2RKF1911X      | Panasonic       | R18               | 1   |
| 16     | 1.21K          | 0402   | RES 1.21K OHM 1/10W 1% 0402 SMD  | ERJ-2RKF1211X      | Panasonic       | R17               | 1   |
| 17     | 47K            | 0402   | RES 47.0K OHM 1/16W 1% 0402 SMD  | RC0402FR-0747KLL   | Yageo           | R8,9              | 2   |
| 18     | 0              | 0402   | RES 0.0 OHM 1/10W 0402 SMD   | ERJ-2GE0R00X       | Panasonic       | R1,2,3,4,5,6,7,10 | 8   |
| 19     | 4:1 Balun      | SM-22  | 4:1 Center Tap Balun   | TC4-1TG2+          | Mini Circuits   | T1,2              | 2   |
| 20     | F1102          | QFN-36 | Diversity Downconverter (400 - 1000 MHz)   | F1102NBGI          | IDT             | U1                | 1   |
| 21     | PCB            |        | EV Kit   | F1102 EVkit Rev5   |                 |                   | 1   |

**Modified BOM and EVKit (for 400 MHz bands):**

EVkit Modifications for High Side Injection 400 MHz operation (see TOCs on pages 15 – 17)

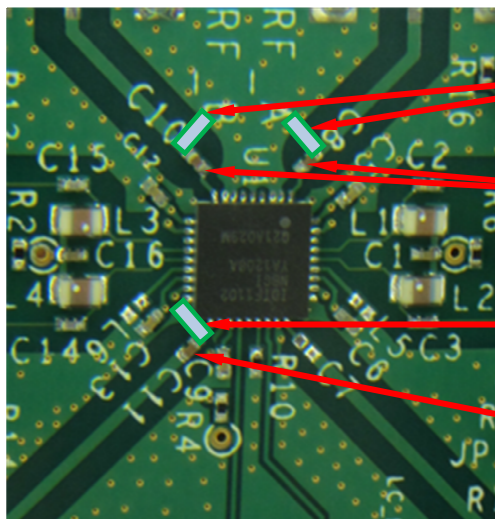

Scrape resist from ground and add shunt 8 pF

Replace C8 and C10 with 18 pF

Scrape resist from ground and add shunt 1.8 pF

Replace C11 with 6.8 pF

RF to IF Dual Downconverting Mixer

400 – 1000 MHz F1102NBGI

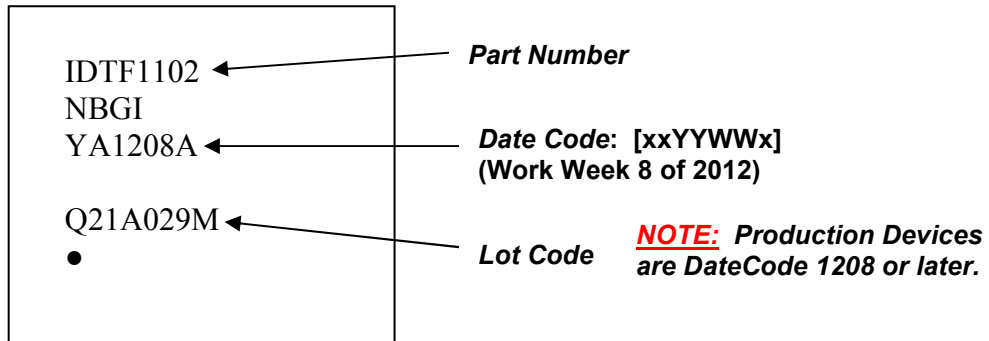
**TOPMARKINGS**

## IMPORTANT NOTICE AND DISCLAIMER

RENESAS ELECTRONICS CORPORATION AND ITS SUBSIDIARIES (“RENESAS”) PROVIDES TECHNICAL SPECIFICATIONS AND RELIABILITY DATA (INCLUDING DATASHEETS), DESIGN RESOURCES (INCLUDING REFERENCE DESIGNS), APPLICATION OR OTHER DESIGN ADVICE, WEB TOOLS, SAFETY INFORMATION, AND OTHER RESOURCES “AS IS” AND WITH ALL FAULTS, AND DISCLAIMS ALL WARRANTIES, EXPRESS OR IMPLIED, INCLUDING, WITHOUT LIMITATION, ANY IMPLIED WARRANTIES OF MERCHANTABILITY, FITNESS FOR A PARTICULAR PURPOSE, OR NON-INFRINGEMENT OF THIRD PARTY INTELLECTUAL PROPERTY RIGHTS.

These resources are intended for developers skilled in the art designing with Renesas products. You are solely responsible for (1) selecting the appropriate products for your application, (2) designing, validating, and testing your application, and (3) ensuring your application meets applicable standards, and any other safety, security, or other requirements. These resources are subject to change without notice. Renesas grants you permission to use these resources only for development of an application that uses Renesas products. Other reproduction or use of these resources is strictly prohibited. No license is granted to any other Renesas intellectual property or to any third party intellectual property. Renesas disclaims responsibility for, and you will fully indemnify Renesas and its representatives against, any claims, damages, costs, losses, or liabilities arising out of your use of these resources. Renesas' products are provided only subject to Renesas' Terms and Conditions of Sale or other applicable terms agreed to in writing. No use of any Renesas resources expands or otherwise alters any applicable warranties or warranty disclaimers for these products.

(Rev.1.0 Mar 2020)

### Corporate Headquarters

TOYOSU FORESIA, 3-2-24 Toyosu,  
Koto-ku, Tokyo 135-0061, Japan  
[www.renesas.com](http://www.renesas.com)

### Contact Information

For further information on a product, technology, the most up-to-date version of a document, or your nearest sales office, please visit:  
[www.renesas.com/contact/](http://www.renesas.com/contact/)

### Trademarks

Renesas and the Renesas logo are trademarks of Renesas Electronics Corporation. All trademarks and registered trademarks are the property of their respective owners.

## X-ON Electronics

Largest Supplier of Electrical and Electronic Components

*Click to view similar products for [Up-Down Converters](#) category:*

*Click to view products by [Renesas](#) manufacturer:*

Other Similar products are found below :

[F1102NBGI8](#) [LA8153QA-WH](#) [F1162NBGI](#) [F1178NBGI](#) [SKY73062-11](#) [MY87C](#) [CSM2-10](#) [CHR3762-QDG](#) [HMC966LP4E](#) [HMC977LP4E](#)  
[F1152NBGI](#) [CMX975Q4](#) [MAX2673EUA+](#) [HSP50216KIZ](#) [MAX2680EUT+T](#) [MAX2660EUT+T](#) [MAX2681EUT+T](#) [MAX2671EUT+T](#)  
[MAX2682EUT+T](#) [LM15851NKE](#) [LM97593VH/NOPB](#) [TFF1015HNN1,115](#)