

GENERAL DESCRIPTION

This document describes the specifications for the IDTF1192B Dual Wideband, Gain-Settable, Zero-Distortion™ Flat-Noise™, RF to IF Downconverting Mixer.

The F1192B has been optimized for GSM systems as well as those utilizing LTE.

The F1192B offers very low power consumption with excellent linearity. In addition to this and the four dynamically adjustable gain settings, the F1192B performance is exceptional across an extremely broad range of RF and IF frequencies. All of this makes it ideal for myriad applications including:

- 2G/3G/4G/5G/Multimode Remote Radio Units
- High order MIMO systems, µcells, picocells, DAS
- Point to Point µWave Backhaul systems
- Broadband Repeaters
- Public Safety Infrastructure
- Any radio system operating between 400 MHz and 4000 MHz

COMPETITIVE ADVANTAGE

F1192B offers maximum performance and flexibility at minimum power consumption. The unique and patented settable-gain feature allows it to be used in a very wide variety of radiocard applications, even allowing for dynamic adjustment of gain to maximize performance on the fly. The extremely wide RF and IF bandwidths are achieved with a fixed BOM with all internal matching. The device can function with as little as -6 dBm LO power and with independent channel shutdown modes for ease of integration into high order TDD MIMO systems.

BAND PERFORMANCE SUMMARY

RF Frequency (MHz)	900	1900	2600	3500
Gain (max G ₁₁ setting)	11.0	10.8	10.3	9.0
Gain (min G ₂ setting)	2.5	2.3	1.8	0.5
NF @ max gain (dB)	8.9	8.7	10.0	10.9
IIP3 @ min gain (dBm)	28	27	29	30
OIP3 @ G ₈ (dBm)	37	34	35	35
IP1dB @ min gain (dBm)	13.6	14.7	14.6	15.8
2x2 @ min gain (dBc)	-75	-82	-73	-68
Channel Isolation (dB)	48	47	48	45
Pdiss (mW)	792	835	875	935

FEATURES

- RF range: 400MHz to 3800MHz
- LO range: 400MHz to 3600MHz
- IF Range: 50MHz to 600MHz
- Dual Path for MIMO
- 4 Gain Settings; 11dB, 8dB, 5dB, 2dB
- 2 bit gain step control
- Ideal for Multi-Carrier Systems
- +35dBm OIP3
- Low Noise Figure at any gain setting via IDT's FlatNoise™ technology
- Z = 200 Ω IF balanced, 50 Ω RF, 50 Ω LO single ended
- All internally matched. Single BOM for all RF, LO and IF frequencies
- 4 mm x 4 mm, 24-pin TQFN package
- Independent Path Standby mode
- 75 nsec settling for gain adjustment
- VCC = 3.3V, 835 mW, 620 mW (low power mode)

FUNCTIONAL BLOCK DIAGRAM

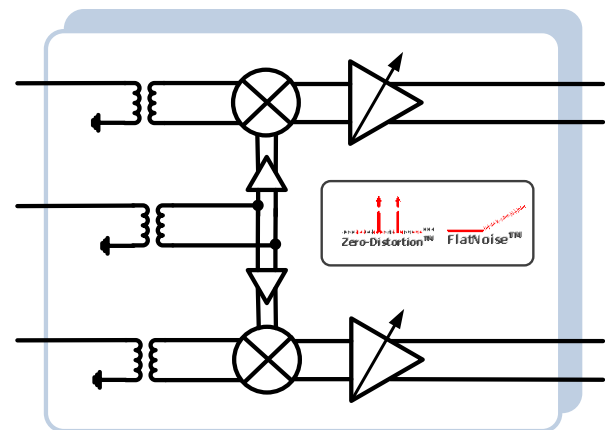

ABSOLUTE MAXIMUM RATINGS

Parameter	Symbol	Min	Max	Units
VCC to GND	V _{CC}	-0.5	+3.6	V
STBY_A, STBY_B, Gain_Select1, Gain_Select2, RF_A, RF_B, LO1_ADJ, LO2_ADJ	V _{CTRL}	-0.5	V _{CC} + 0.5	V
IF_A+, IF_A-, IF_B+, IF_B-	IF _{OUT}	2.4	V _{CC} + 0.5	V
LO_IN	LO _{IN}	-0.5	+0.5	V
IF_BiasA, IF_BiasB	IF _{BIAS}		50	ohms
IF_Ref_Bias	IF _{REF}		500	ohms
RF Input Power (RF_A, RF_B) continuous	RF _{MAX}		+20	dBm
LO Input Power (LO_IN) continuous	LO _{MAX}		+20	dBm
Continuous Power Dissipation	P _{DISS}		1.5	W
Junction Temperature	T _J		150	°C
Storage Temperature Range	T _{ST}	-65	150	°C
Lead Temperature (soldering, 10s)	T _{LEAD}		260	°C
ElectroStatic Discharge – HBM (JEDEC/ESDA JS-001-2012)			Class 2 (2500 V)	
ElectroStatic Discharge – CDM (JEDEC 22-C101F)			Class C3 (1000 V)	

Stresses above those listed above may cause permanent damage to the device. Functional operation of the device at these or any other conditions above those indicated in the operational section of this specification is not implied. Exposure to absolute maximum rating conditions for extended periods may affect device reliability.

PACKAGE THERMAL AND MOISTURE CHARACTERISTICS

θ_{JA} (Junction – Ambient)	45 °C/W
θ_{JC} (Junction – Case) [The Case is defined as the exposed paddle]	2.1 °C/W
Moisture Sensitivity Rating (Per J-STD-020)	MSL1

F1192B RECOMMENDED OPERATING CONDITIONS

Parameter	Symbol	Comment	min	typ	max	Units
Supply Voltage(s)	V_{CC}	All V_{CC} pins	3.15		3.45	V
Operating Temperature Range	T_{CASE}	Case Temperature	-40		+105	deg C
RF Freq Range	F_{RF}		400		3800	MHz
LO Freq Range	F_{LO}		400		3600	
IF Range	F_{IF}		50		600	
LO Power	P_{LO}	Operating Range	-6		+6	dBm

IDTF1192B SPECIFICATION (GENERAL)

Typical Application Circuit, $V_{CC} = +3.3V$, $T_C = +25^\circ C$, $F_{RF} = 900MHz$, $F_{IF} = 199MHz$, $F_{LO} = 1100MHz$, $P_{LO} = 0\text{ dBm}$, $P_{IN} = -10\text{dBm}$ per tone for all gain settings unless otherwise stated, $STBY_A = STBY_B = LOW$. EVkit IF transformer losses are de-embedded unless otherwise noted.

Parameter	Symbol	Comment	min	typ	max	units
Logic Input High ³	V_{IH}	For all control pins	1.1¹			V
Logic Input Low ³	V_{IL}	For all control pins			0.65	V
Logic Current	I_{IH}, I_{IL}	For all control pins	-5		+100	μA
Supply Current	$I_{1CHA\ LB}$	Single channel - low band LO		134	154	mA
	$I_{1CHA\ MB}$	Single channel - mid band LO		140	160	
	$I_{1CHA\ HB}$	Single channel - high band LO		147	166	
	$I_{2CHA\ LB}$	Dual channel - low band LO		240	275	
	$I_{2CHA\ MB}$	Dual channel - mid band LO		253	287	
	$I_{2CHA\ HB}$	Dual channel - high band LO		265	299	
Supply Current – reduced linearity		<ul style="list-style-type: none"> Dual channel $F_{RF} = 2.2GHz$, $F_{LO} = 2GHz$ OIP3 = +20dBm max gain IFRef_Bias resistor = 3.9Kohm 		194	220	
Shutdown current	$I_{SD\ 2CHA}$	Both Channels		3	6	
Settling Time	T_{SETT}	<ul style="list-style-type: none"> Pin = -13 dBm Gate STBY pins per Independent Channel Standby table Time for IF Signal to settle from 50% CTRL to within 90% of final value 		340		nsec
		<ul style="list-style-type: none"> Pin = -13 dBm Gate STBY pins per Independent Channel Standby table Time for IF Signal to settle from 50% CTRL to within 0.1 dB of final value 		920		
		<ul style="list-style-type: none"> Pin = -13 dBm Gate Gain Select pins per Gain Control table Time for IF Signal to settle from 50% Gain Select to within 90% of final value 		75		
RFIN Impedance	Z_{RFIN}	Single Ended		50		Ω
LO Port Impedance	Z_{LO}	Single Ended		50		
IF Output Impedance	Z_{IF}	Differential		200		
IF Return Loss	RL_{IF}	Differential 200 ohm with 4:1 Balun		-15		dB
LO Return Loss	RL_{LO}	Single Ended 50 ohm		-15		dB

Note 1: Items in min/max columns in **bold italics** are Guaranteed by Test.

Note 2: Items in min/max columns that are not bold/italics are Guaranteed by Design Characterization.

Note 3: JEDEC 3.3V and JEDEC 1.8V logic

IDTF1192B SPECIFICATION (LOW BAND)

Typical Application Circuit, $V_{CC} = +3.3V$, $T_C = +25^\circ C$, $F_{RF} = 900MHz$, $F_{IF} = 199MHz$, $F_{LO} = 1100MHz$, $P_{LO} = 0 dBm$, $P_{IN} = -10dBm$ per tone for all gain settings unless otherwise stated, $STBY_A = STBY_B = LOW$. EVkit IF transformer losses are de-embedded unless otherwise noted. Gain Setting = G_5 (~ 5 dB gain).

Parameter	Symbol	Comment	min	typ	max	units
Power Gain	G_{11}	Gain setting = G_{11}		11.1		dB
	G_8	Gain setting = G_8		8.3		
	G_5	Gain setting = G_5	4.05	5.4	6.75	
	G_2	Gain setting = G_2		2.5		
G5 Gain Change over temp	$G5_{TempDrift}$	Tcase -40C to +105C referenced to +25C		+0.7 -0.7		dB
Gain Slope	$Gain_{SLOPE}$	<ul style="list-style-type: none"> IF center 200MHz 100MHz BW 		+ 0.006		dB/MHz
Noise Figure	NF_{G11}	Gain setting = G_{11}		8.9		dB
	NF_{G8}	Gain setting = G_8		9.4		
	$NF_{G5}^{4,5}$	Gain setting = G_5		10.1	11.7	
	NF_{G2}	Gain setting = G_2		10.7		
Input IP3	$IIP3_{G11}$	Gain setting = G_{11} 800 kHz tone separation		24		dBm
	$IIP3_{G8}$	Gain setting = G_8 800 kHz tone separation		29		
	$IIP3_{G5}^4$	Gain setting = G_5 800 kHz tone separation	26	28		
	$IIP3_{G2}$	Gain setting = G_2 800 kHz tone separation		28		
G3 IIP3 change over temp	$IIP3_{G3TempDrift}$	Tcase -40C / +105C referenced to +25C		-2.6/ +0.6		dB
Output IP3	$OIP3_{G11}$	Gain setting = G_{11} 800 kHz tone separation		35		dBm
	$OIP3_{G8}$	Gain setting = G_8 800 kHz tone separation		37		
	$OIP3_{G5}$	Gain setting = G_5 800 kHz tone separation		32		
		<ul style="list-style-type: none"> Gain setting = G_5 $T_c = +105^\circ C$ LO power = -3dBm $V_{cc} = 3.15V$ 	33	34		
	$OIP3_{G2}$	Gain setting = G_2 800 kHz tone separation		30		

IDTF1192B SPECIFICATION (LOW BAND) CONTINUED

Typical Application Circuit, $V_{CC} = +3.3V$, $T_C = +25^\circ C$, $F_{RF} = 900MHz$, $F_{IF} = 199MHz$, $F_{LO} = 1100MHz$, $P_{LO} = 0\text{ dBm}$, $P_{IN} = -10\text{dBm}$ per tone for all gain settings unless otherwise stated, $STBY_A = STBY_B = LOW$. EVkit IF transformer losses are de-embedded unless otherwise noted. Gain Setting = G_5 (~ 5 dB gain).

Parameter	Symbol	Comment	min	typ	max	units
Input P1dB	IP1dB _{G11}	Gain setting = G_{11}		7.0		dBm
	IP1dB _{G8}	Gain setting = G_8		9.2		
	IP1dB _{G5} ⁴	Gain setting = G_5	10.4	11.8		
	IP1dB _{G2}	Gain setting = G_2		13.6		
Maximum saturated output power	Psat	Pin up to +20dBm		17		dBm
2RF – 2LO rejection	2x2 ⁶	<ul style="list-style-type: none"> ▪ $P_{RF} = -10\text{ dBm}$ ▪ $F_{RFspur} = F_{LO} - F_{IF}/2$ 		-75	-73	dBc
3RF – 3LO rejection	3x3	<ul style="list-style-type: none"> ▪ $P_{RF} = -10\text{ dBm}$ ▪ $F_{RFspur} = F_{LO} - F_{IF}/3$ 		-75		dBc
Channel Isolation	ISO _C	IF_B Pout versus IF_A w/ RF_A input	47	48		dB
LO to IF leakage	ISO _{LI}			-38	-35	dBm
2LO to IF leakage	ISO _{LI2}			-25		dBm
3LO to IF leakage	ISO _{LI3}			-49		dBm
4LO to IF leakage	ISO _{LI4}			-45		dBm
RF to IF leakage	ISO _{RI}	RF output power compared to measured IF output power		-25	-23	dBc
LO to RF leakage	ISO _{LR}			-52		dBm
RF Return Loss	RL _{RF}	Single Ended 50 ohm		-12		dB

- 1 – Items in min/max columns in ***bold italics*** are Guaranteed by Test
- 2 – All other Items in min/max columns are Guaranteed by Design Characterization
- 3 – JEDEC 3.3V and JEDEC 1.8V logic
- 4 – Specification limits over voltage and temperature
- 5 – Max limit at Tcase = +105C
- 6 – Max limit over temperature extremes

IDTF1192B SPECIFICATION (MID BAND)

Typical Application Circuit, $V_{CC} = +3.3V$, $T_C = +25^\circ C$, $F_{RF} = 1900\text{ MHz}$, $F_{IF} = 199\text{ MHz}$, $F_{LO} = 1700\text{ MHz}$, $P_{LO} = 0\text{ dBm}$, $P_{IN} = -10\text{ dBm}$ per tone for all gain settings unless otherwise stated, $STBY_A = STBY_B = \text{LOW}$. EVkit IF transformer losses are de-embedded unless otherwise noted. Gain Setting = G_5 (~ 5 dB gain)

Parameter	Symbol	Comment	min	typ	max	units
Power Gain	G_{11}	Gain setting = G_{11}		10.8		dB
	G_8	Gain setting = G_8		8.1		
	G_5	Gain setting = G_5	3.75	5.1	6.45	
	G_2	Gain setting = G_2		2.3		
G5 Gain Change over temp	$G5_{TempDrift}$	Tcase -40C to +105C referenced to +25C		+0.7 -0.6		dB
Gain Slope	$Gain_{SLOPE}$	<ul style="list-style-type: none"> IF center 200MHz 100MHz BW 		+0.006		dB/MHz
Noise Figure	NF_{G11}	Gain setting = G_{11}		8.7		dB
	NF_{G8}	Gain setting = G_8		9.1		
	$NF_{G5}^{4,5}$	Gain setting = G_5		9.8	11.4	
	NF_{G2}	Gain setting = G_2		10.7		
Blocking NF	NF_{BLK}	<ul style="list-style-type: none"> Gain Setting = G_{11} +100MHz offset blocker Pin = +4dBm 		17		dB
Input IP3	$IIP3_{G11}$	Gain setting = G_{11} 800 kHz tone separation		23		dBm
	$IIP3_{G8}$	Gain setting = G_8 800 kHz tone separation		25		
	$IIP3_{G5}^4$	Gain setting = G_5 800 kHz tone separation	25	26		
	$IIP3_{G2}$	Gain setting = G_2 800 kHz tone separation		27		
G3 IIP3 change over temp	$IIP3_{G3TempDrift}$	Tcase -40C / +105C referenced to +25C		-0.2/ +5		dB
Output IP3	$OIP3_{G11}$	Gain setting = G_{11} 800 kHz tone separation		33.6		dBm
	$OIP3_{G8}$	Gain setting = G_8 800 kHz tone separation		33.6		
	$OIP3_{G5}$	Gain setting = G_5 800 kHz tone separation	29	31.0		
		<ul style="list-style-type: none"> Gain setting = G_5 $T_c = +105^\circ C$ LO power = -3dBm $V_{cc} = 3.15V$ 	28.8	29.5		
$OIP3_{G2}$	Gain setting = G_2 800 kHz tone separation		29.0			

IDTF1192B SPECIFICATION (MID BAND) CONTINUED

Typical Application Circuit, $V_{CC} = +3.3V$, $T_C = +25^\circ C$, $F_{RF} = 1900\text{ MHz}$, $F_{IF} = 199\text{ MHz}$, $F_{LO} = 1700\text{ MHz}$, $P_{LO} = 0\text{ dBm}$, $P_{IN} = -10\text{ dBm}$ per tone for all gain settings unless otherwise stated, $STBY_A = STBY_B = \text{LOW}$. EVkit IF transformer losses are de-embedded unless otherwise noted. Gain Setting = G_5 (~ 5 dB gain)

Parameter	Symbol	Comment	min	typ	max	units
Input P1dB	$IP1dB_{G11}$	Gain setting = G_{11}	6.0	7.7		dBm
	$IP1dB_{G8}$	Gain setting = G_8		10.1		
	$IP1dB_{G5}^4$	Gain setting = G_5	11.3	12.7		
	$IP1dB_{G2}$	Gain setting = G_2		14.7		
Maximum saturated output power	$Psat$	Pin up to +20dBm		17		dBm
2RF – 2LO rejection	$2x2^6$	<ul style="list-style-type: none"> ▪ $P_{RF} = -10\text{ dBm}$ ▪ $F_{RFspur} = F_{LO} + F_{IF}/2$ 		-82	-71	dBc
3RF – 3LO rejection	$3x3$	<ul style="list-style-type: none"> ▪ $P_{RF} = -10\text{ dBm}$ ▪ $F_{RFspur} = F_{LO} + F_{IF}/3$ 		-76		dBc
Channel Isolation	ISO_C	IF_B Pout versus IF_A w/ RF_A input	40	47		dB
LO to IF leakage	ISO_{LI}			-31	-22	dBm
2LO to IF leakage	ISO_{LI2}			-20		dBm
3LO to IF leakage	ISO_{LI3}			-59		dBm
4LO to IF leakage	ISO_{LI4}			-44		dBm
RF to IF leakage	ISO_{RI}	RF output power compared to measured IF output power		-25	-20	dBc
LO to RF leakage	ISO_{LR}			-46		dBm
RF Return Loss	RL_{RF}	Single Ended 50 ohm		-13		dB

- 1 – Items in min/max columns in ***bold italics*** are Guaranteed by Test
- 2 – All other Items in min/max columns are Guaranteed by Design Characterization
- 3 – JEDEC 3.3V and JEDEC 1.8V logic
- 4 – Specification limits over voltage and temperature
- 5 – Max limit at $T_{case} = +105^\circ C$
- 6 – Max limit over temperature extremes

IDTF1192B SPECIFICATION (HIGH BAND)

Typical Application Circuit, $V_{CC} = +3.3V$, $T_C = +25^\circ C$, $F_{RF} = 2600MHz$, $F_{IF} = 199MHz$, $F_{LO} = 2400MHz$, $P_{LO} = 0\text{ dBm}$, $P_{IN} = -10dBm$ per tone for all gain settings unless otherwise stated, $STBY_A = STBY_B = LOW$. EVkit IF transformer losses are de-embedded unless otherwise noted. Gain Setting = G_5 (~ 5 dB gain)

Parameter	Symbol	Comment	min	typ	max	units
Power Gain	G_{11}	Gain setting = G_{11}		10.3		dB
	G_8	Gain setting = G_8		7.5		
	G_5	Gain setting = G_5	3.25	4.6	5.95	
		<ul style="list-style-type: none"> • Gain setting = G_5 • $F_{IF} = 469MHz$ • $F_{LO} = 2130MHz$ 	2.4	4.0	5.6	
	G_2	Gain setting = G_2		1.8		
G5 Gain Change over temp	$G5_{TempDrift}$	Tcase -40C to +105C referenced to +25C		+0.7 -0.7		dB
Gain Slope	$Gain_{SLOPE1}$	<ul style="list-style-type: none"> • IF center 200MHz • 100MHz BW 		+0.006		dB/MHz
	$Gain_{SLOPE2}$	<ul style="list-style-type: none"> • IF center 370MHz • 200MHz BW 		+0.008		dB/MHz
Noise Figure	NF_{G11}	Gain setting = G_{11}		10.0		dB
	NF_{G8}	Gain setting = G_8		10.4		
	$NF_{G5}^{4,5}$	Gain setting = G_5		11.1	13	
		<ul style="list-style-type: none"> • Gain setting = G_5 • $F_{IF} = 469MHz$ • $F_{LO} = 2130MHz$ 		11.8		
	NF_{G2}	Gain setting = G_2		11.9		
Input IP3	$IIP3_{G11}$	Gain setting = G_{11} 800 kHz tone separation		24		dBm
	$IIP3_{G8}$	Gain setting = G_8 800 kHz tone separation		28		
	$IIP3_{G5}^4$	Gain setting = G_5 800 kHz tone separation	25	28		
	$IIP3_{G2}$	Gain setting = G_2 800 kHz tone separation		29		
G3 IIP3 change over temp	$IIP3_{G3TempDrift}$	Tcase -40C / +105C referenced to +25C		-0.8/ +1.8		dB

IDTF1192B SPECIFICATION (HIGH BAND) CONTINUED

Typical Application Circuit, $V_{CC} = +3.3V$, $T_C = +25^\circ C$, $F_{RF} = 2600MHz$, $F_{IF} = 199MHz$, $F_{LO} = 2400MHz$, $P_{LO} = 0\text{ dBm}$, $P_{IN} = -10\text{dBm}$ per tone for all gain settings unless otherwise stated, $STBY_A = STBY_B = LOW$. EVkit IF transformer losses are de-embedded unless otherwise noted. Gain Setting = G_5 (~ 5 dB gain)

Parameter	Symbol	Comment	min	typ	max	units
Output IP3	OIP3 _{G11}	Gain setting = G_{11} 800 kHz tone separation		34.7		dBm
	OIP3 _{G8}	Gain setting = G_8 800 kHz tone separation		35.4		
	OIP3 _{G5}	Gain setting = G_5 800 kHz tone separation		32.5		
		• Gain setting = G_5 • $T_C = +105^\circ C$ • LO power = -3dBm • $V_{CC} = 3.15V$	28.4	29.3		
		• Gain setting = G_5 • $F_{IF} = 469MHz$ • $F_{LO} = 2130MHz$		31.0		
OIP3 _{G2}	Gain setting = G_2 800 kHz tone separation		30.5			
Input P1dB	IP1dB _{G11}	Gain setting = G_{11}		8.3		dBm
	IP1dB _{G8}	Gain setting = G_8		10.8		
	IP1dB _{G5} ⁴	Gain setting = G_5	11.8	13.2		
		• Gain setting = G_5 • $F_{IF} = 469MHz$ • $F_{LO} = 2130MHz$		13.1		
IP1dB _{G2}	Gain setting = G_2		14.6			
Maximum saturated output power	Psat	Pin up to +20dBm		17		dBm
2RF – 2LO rejection	2x2 ⁶	<ul style="list-style-type: none"> $P_{RF} = -10\text{ dBm}$ $F_{RFspur} = F_{LO} + F_{IF}/2$ 		-73	-69	dBc
3RF – 3LO rejection	3x3	<ul style="list-style-type: none"> $P_{RF} = -10\text{ dBm}$ $F_{RFspur} = F_{LO} + F_{IF}/2$ 		-76		dBc
Channel Isolation	ISO _C	IF_B Pout versus IF_A w/ RF_A input	46	48		dB
LO to IF leakage	ISO _{LI}			-40	-38	dBm
2LO to IF leakage	ISO _{LI2}			-44		dBm
3LO to IF leakage	ISO _{LI3}			-68		dBm
4LO to IF leakage	ISO _{LI4}			-71		dBm
RF to IF leakage	ISO _{RI}	RF output power compared to measured IF output power		-32	-30	dBc
LO to RF leakage	ISO _{LR}			-51		dBm
RF Return Loss	RL _{RF}	Single Ended 50 ohm		-17		dB

1 – Items in min/max columns in ***bold italics*** are Guaranteed by Test

2 – All other Items in min/max columns are Guaranteed by Design Characterization

3 – JEDEC 3.3V and JEDEC 1.8V logic

4 – Specification limits over voltage and temperature

5 – Max limit at Tcase = +105C

6 – Max limit over temperature extremes

SPUR MEASUREMENTS

NxM (dBc, Gset=5 dB, LO=1700 MHz, IF=200 MHz, Rfund=0 dBm at 1900 MHz, RFspur(MHz)=(N*LO(MHz)+IF(MHz))/M)											
		N (LO)									
		1	2	3	4	5	6	7	8	9	10
M (RF)	1	0.0	37.7	22.0	64.3	39.4	73.3	52.4			
	2	54.3	69.5	53.7	64.2	50.4	57.0	61.3	71.8	62.1	88.7
	3	61.8	73.1	56.0	78.6	60.0	79.1	69.2	83.8	82.2	96.4
	4	68.0	88.8	94.4	91.5	97.2	96.7	87.7	94.1	87.1	98.7
	5	>99	>99	81.1	95.7	94.9	97.8	94.9	>99	86.6	97.3
	6	>99	>99	>99	>99	>99	>99	>99	>99	>99	>99
	7	>99	>99	>99	>99	>99	>99	93.3	>99	>99	>99
	8	>99	>99	>99	>99	>99	>99	>99	>99	>99	>99
	9	>99	>99	>99	>99	>99	>99	>99	>99	>99	>99
	10	>99	>99	>99	>99	>99	>99	>99	>99	>99	>99

NxM (dBc, Gset=5 dB, LO=1700 MHz, IF=200 MHz, Rfund=0 dBm at 1500MHz, RFspur(MHz)=(N*LO(MHz)-IF(MHz))/M)											
		N (LO)									
		1	2	3	4	5	6	7	8	9	10
M (RF)	1	0.0	42.1	19.0	61.0	36.5	77.2	50.1			
	2	49.0	72.4	57.0	60.0	53.9	57.1	63.1	68.0	62.5	85.7
	3	69.8	78.6	51.5	75.9	62.1	75.3	66.0	84.5	76.2	91.4
	4	72.9	86.3	98.3	91.1	97.5	>99	88.2	95.8	93.2	>99
	5	>99	>99	85.2	96.9	86.7	>99	93.2	98.2	88.6	98.3
	6	>99	>99	>99	>99	>99	>99	>99	>99	>99	>99
	7	>99	>99	>99	>99	>99	>99	89.5	>99	>99	>99
	8	>99	>99	>99	>99	>99	>99	>99	>99	>99	>99
	9	>99	>99	>99	>99	>99	>99	>99	>99	>99	>99
	10	>99	>99	>99	>99	>99	>99	>99	>99	>99	98.2

TYPICAL OPERATING CONDITIONS (TOC)

Unless otherwise Noted, the following Apply to the Typ Ops Graphs

- High Side Injection for RF frequencies below 1.2 GHz
- Low Side Injection for RF frequencies from 1.3 to 2.7 GHz
- 199MHz IF
- 800KHz Tone Spacing
- All measurements fully de-embedded for trace, connector, transformer losses
- Pin = -10dBm for 2x2, 3x3, Gain
- Pout = 0 dBm/Tone for IP3
- LO level = 0 dBm, $V_{CC} = 3.30\text{ V}$
- Listed Temperatures are Case Temperature (TC = Case Temperature)
- Where noted, TA or TAMB = Ambient Temperature

TOCs (-1-) Fixed IF = 199 MHz - IIP3, OIP3, and Gain

IIP3 vs. Temperature and Gain Setting

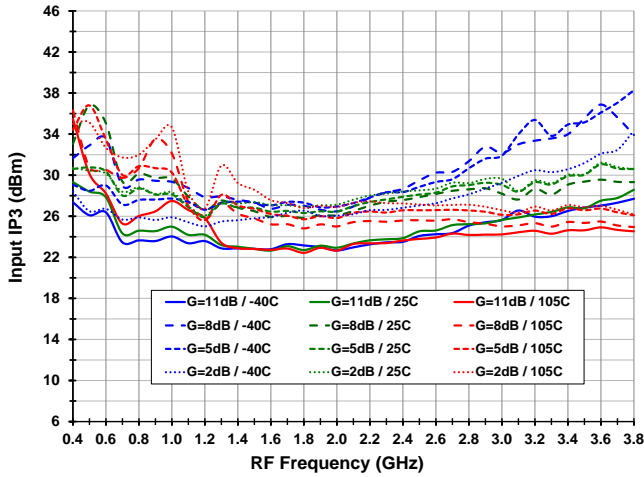

IIP3 vs. LO Power and Gain Setting (Vcc = 3.15, Tcase = 105C)

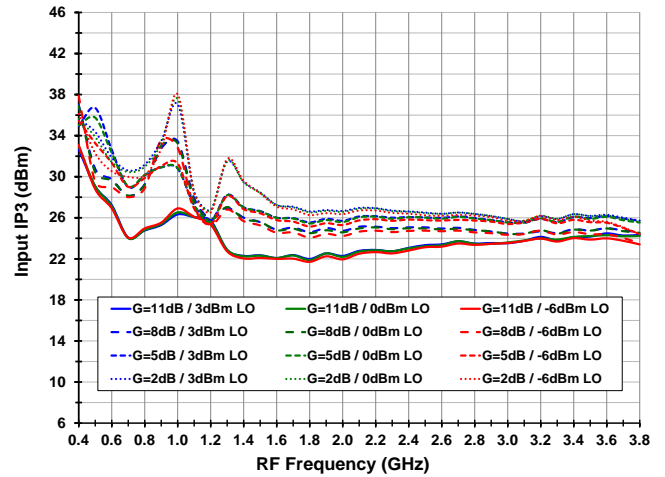

OIP3 vs. Temperature and Gain Setting

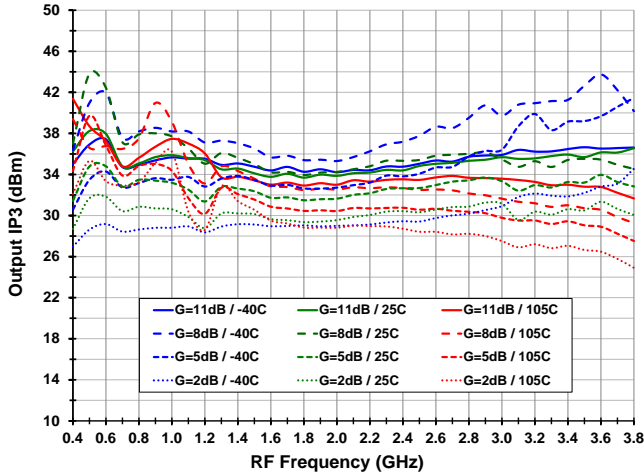

OIP3 vs. LO Power and Gain Setting (Vcc = 3.15, Tcase = 105C)

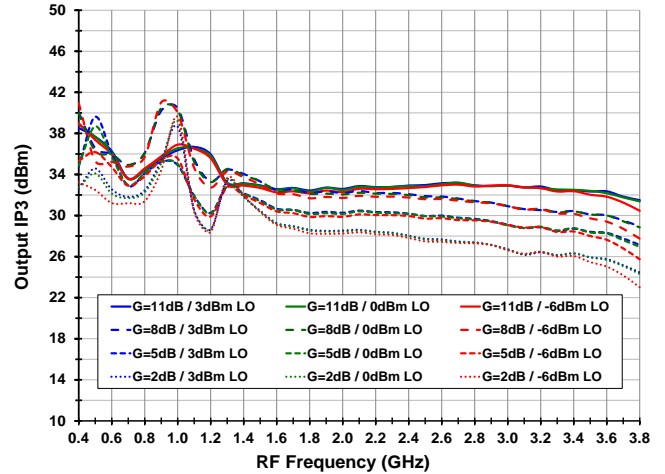

Gain vs. Temperature and Gain Setting

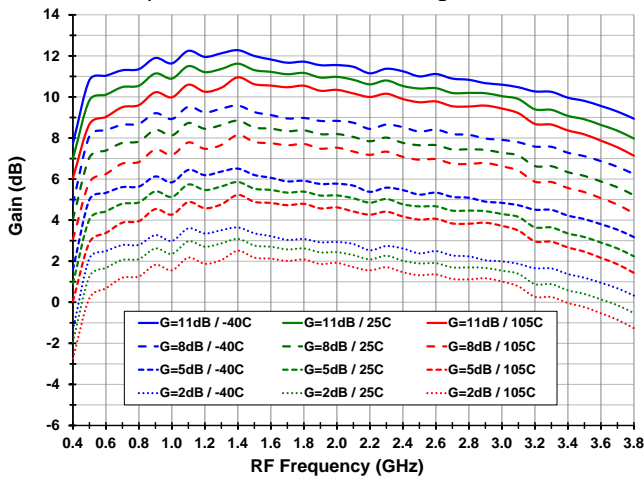

Gain vs. LO Power and Gain Setting (Vcc = 3.15, Tcase = 105C)

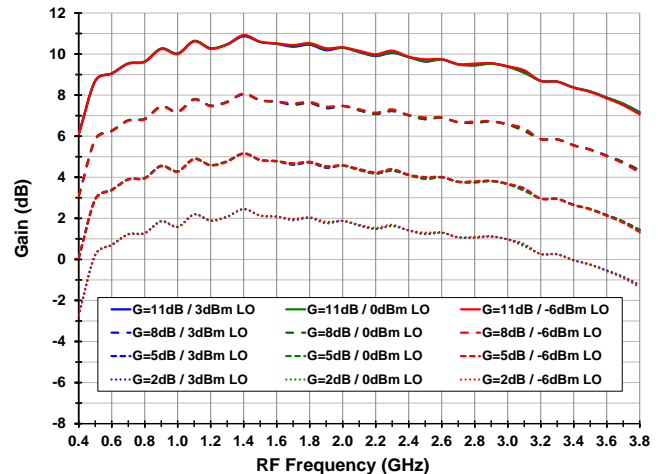

TOCs (-2-) Fixed IF = 199 MHz - 2x2 Rejection, 3x3 Rejection, and P1dB

2x2 Rejection vs. Temperature and Gain Setting

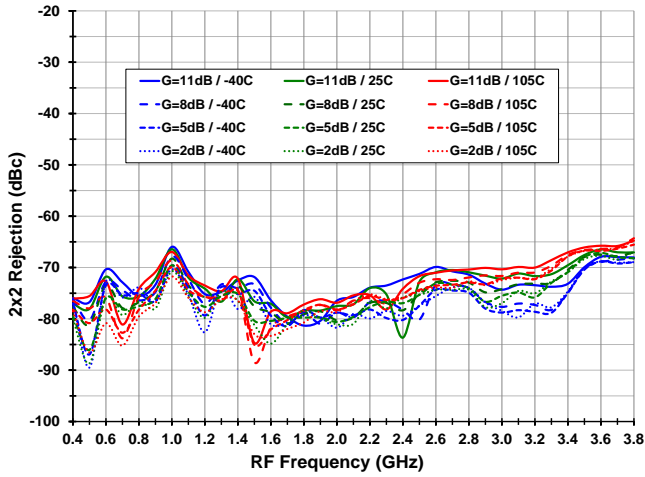

2x2 Rejection vs. LO Power and Gain Setting (Vcc = 3.15, Tcase = 105C)

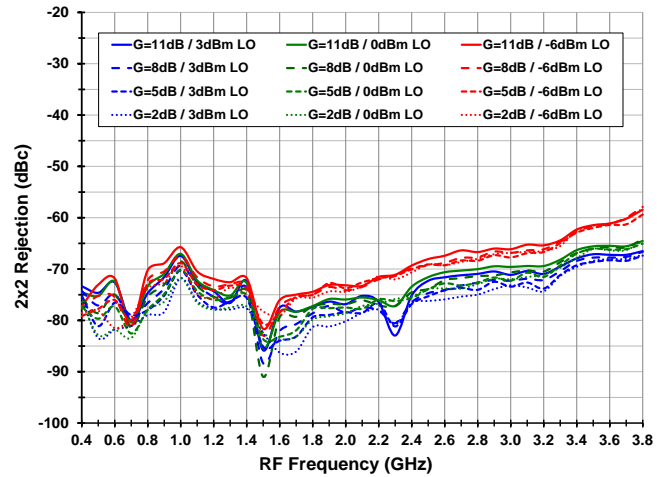

3x3 Rejection vs. Temperature and Gain Setting

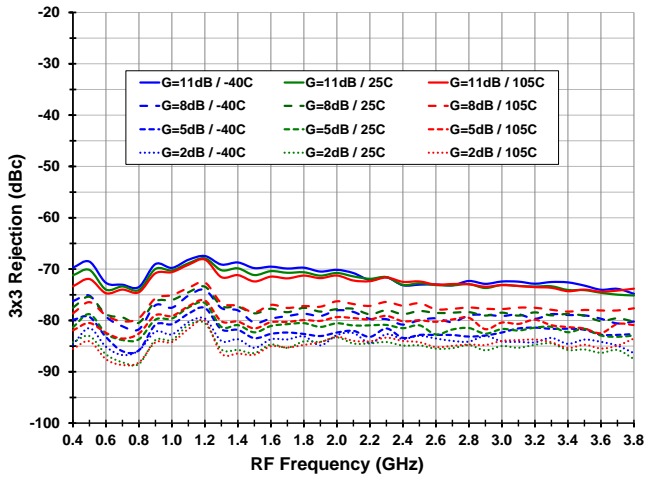

3x3 Rejection vs. LO Power and Gain Setting (Vcc = 3.15, Tcase = 105C)

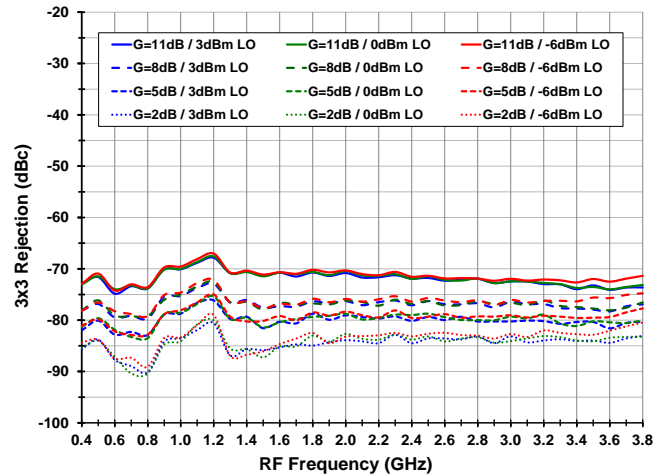

Input P1dB vs. Temperature and Gain Setting

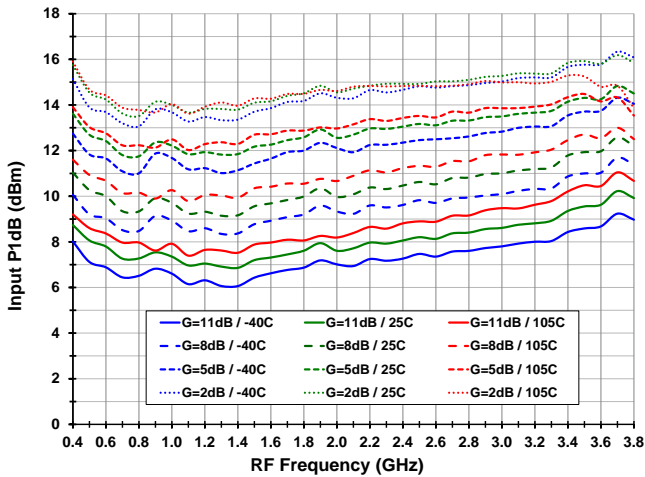

Input P1dB vs. LO Level and Gain Setting (Vcc = 3.15, Tcase = -40C)

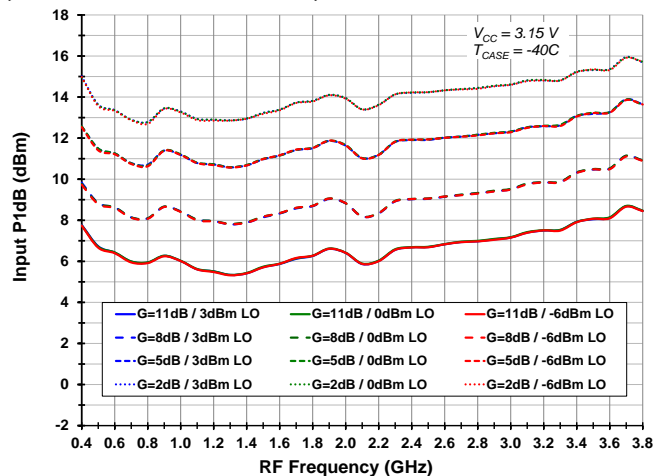

TOCs (-3-) Fixed IF = 199 MHz – Power Consumption, LO to IF Leakage, and RF to IF

Power Consumption vs. Temperature and Gain Setting

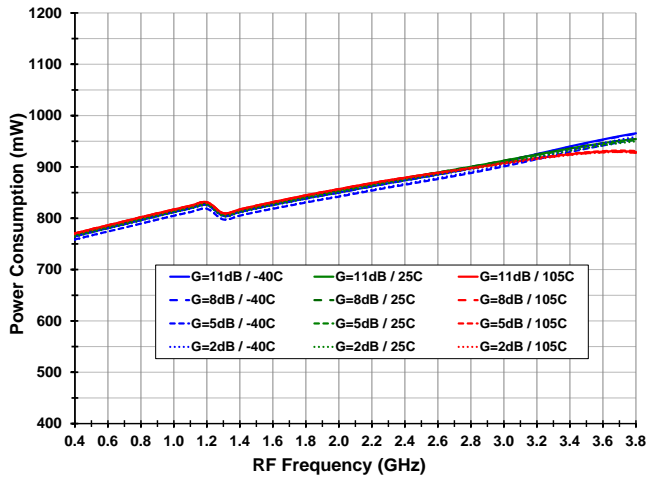

LO to IF Leakage vs. Temperature and Gain Setting

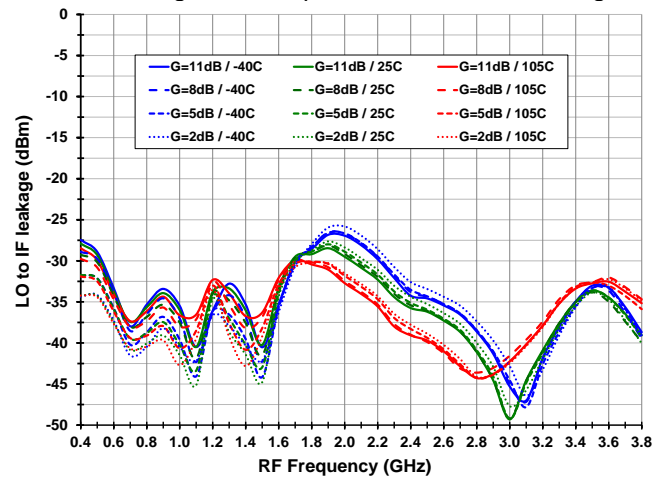

Power Consumption vs. Temperature and Gain Setting (Vcc = 3.15, Tcase = 105C)

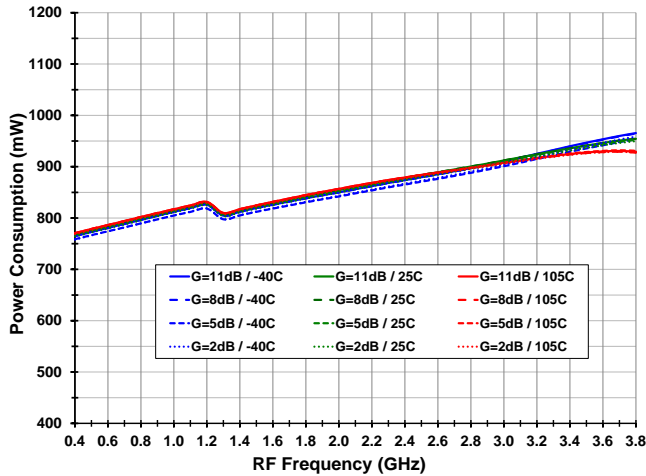

RF to IF Leakage vs. Temperature and Gain Setting

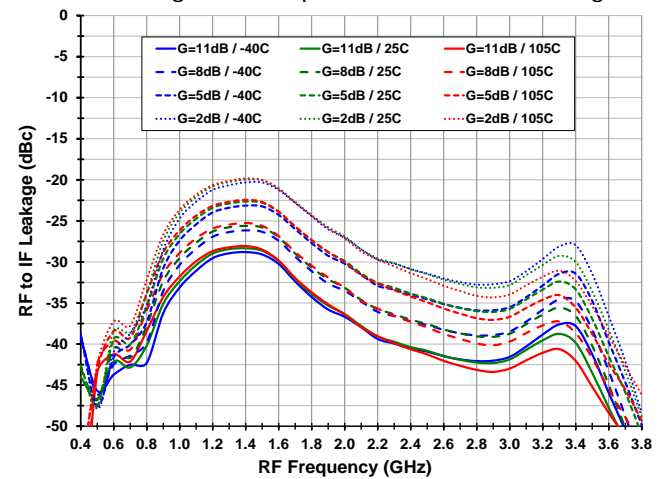

Power Consumption vs. Temperature and Gain Setting (Vcc = 3.45, Tcase = -45C)

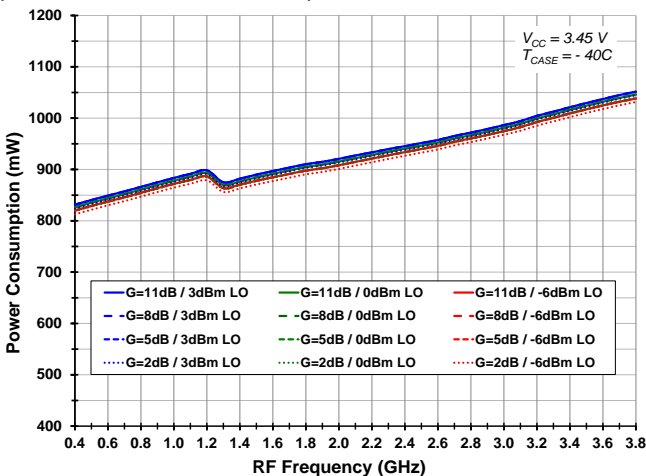

TOCs (-4-) Fixed IF = 199 MHz – Output IP2, Channel Isolation, Noise Figure

Output IP2 vs. Temperature and Gain Setting

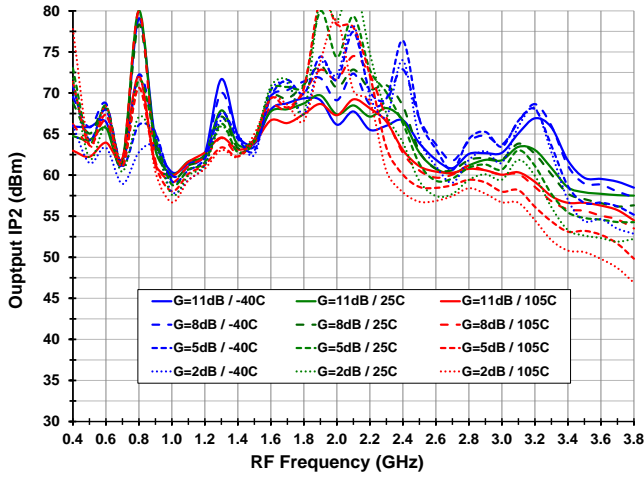

Output IP2 vs. Temperature and Gain Setting (Vcc = 3.15, Tcase = 105C)

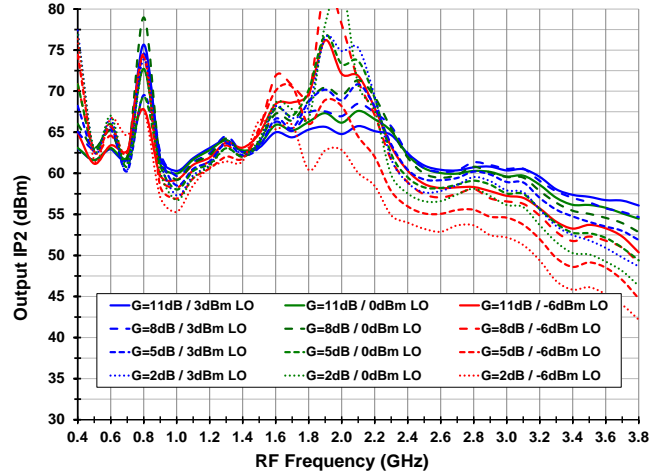

Channel Isolation vs. Temperature and Gain Setting

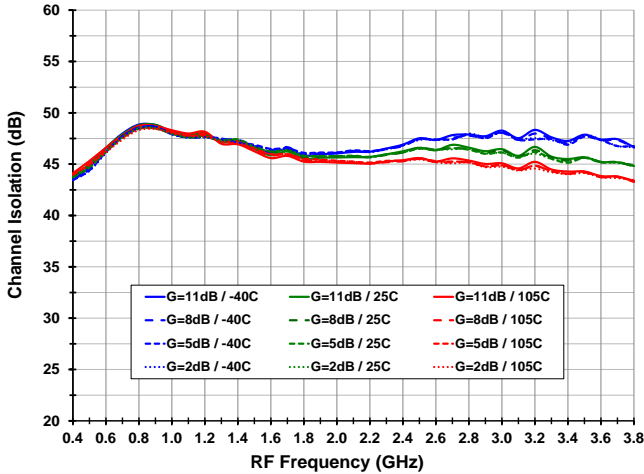

Channel Isolation vs. LO Power and Gain Setting (Vcc = 3.15, Tcase = 105C)

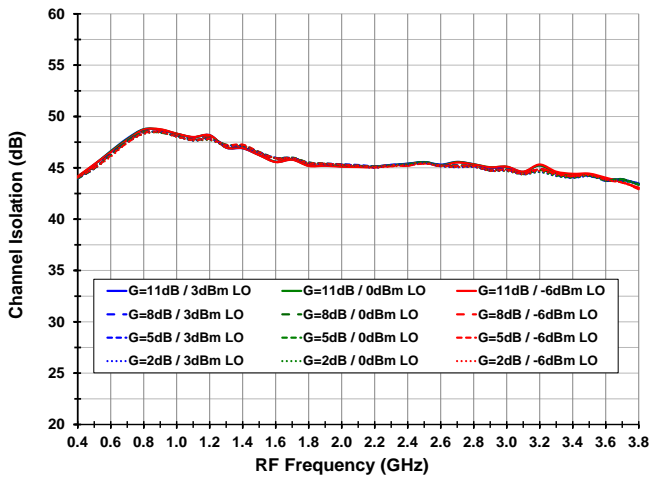

Noise Figure vs. Temperature and Gain Setting

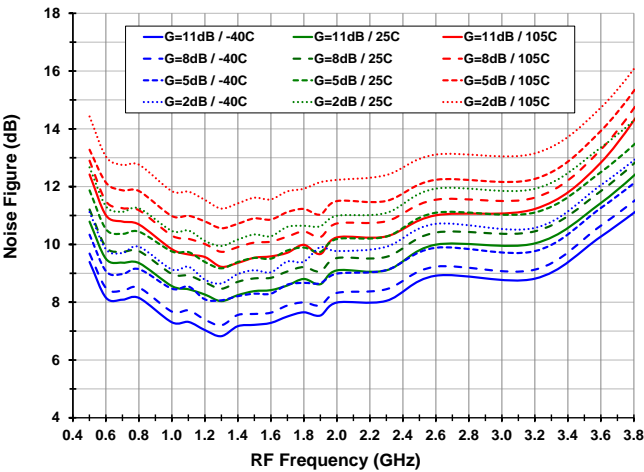

Blocking Noise Figure (Max Gain, LO=1700MHz, RF=1899MHz, Blocker=1999MHz, 25C ambient)

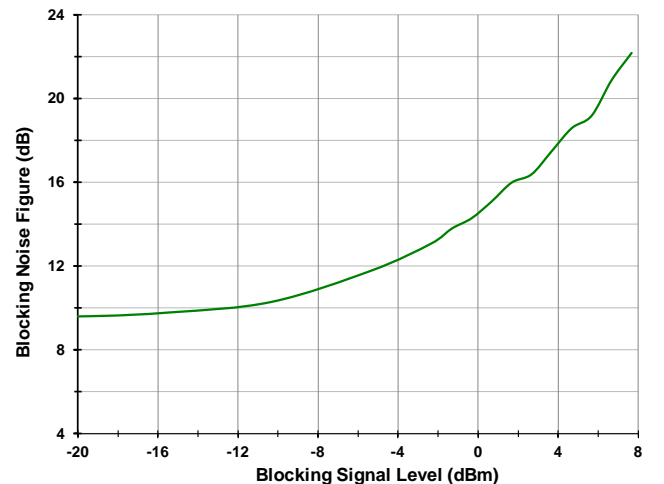

TOCs (-5-) Fixed LO = 1.1 GHz, 1.7 GHz, 2.25 GHz, 3.13 GHz – Input IP3

Input IP3 vs. Temperature and Gain Setting
(LO=1.1 GHz)

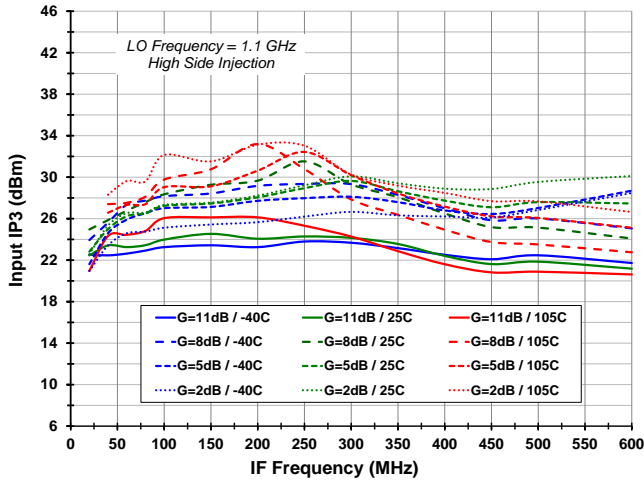

Input IP3 vs. Temperature and Gain Setting
(LO=2.25 GHz)

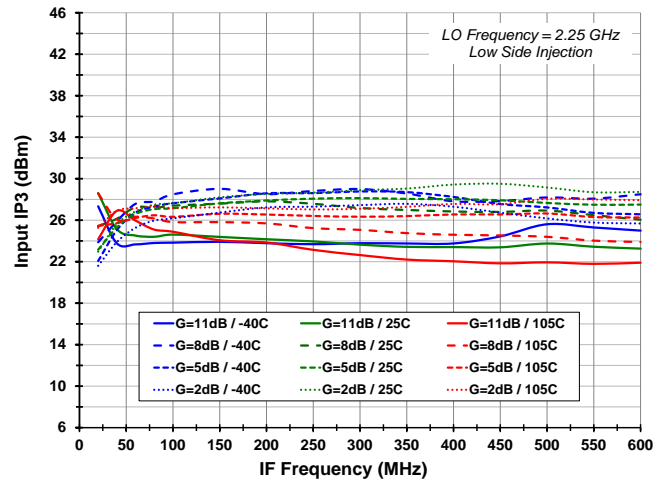

Input IP3 vs. Temperature and Gain Setting
(LO=1.7 GHz)

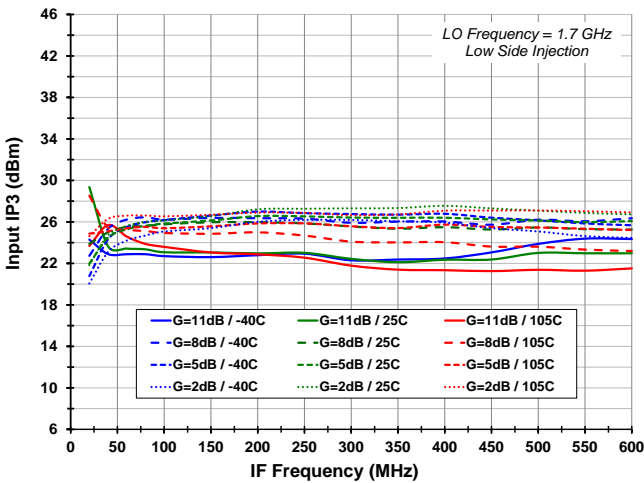

Input IP3 vs. Temperature and Gain Setting
(LO=3.13 GHz)

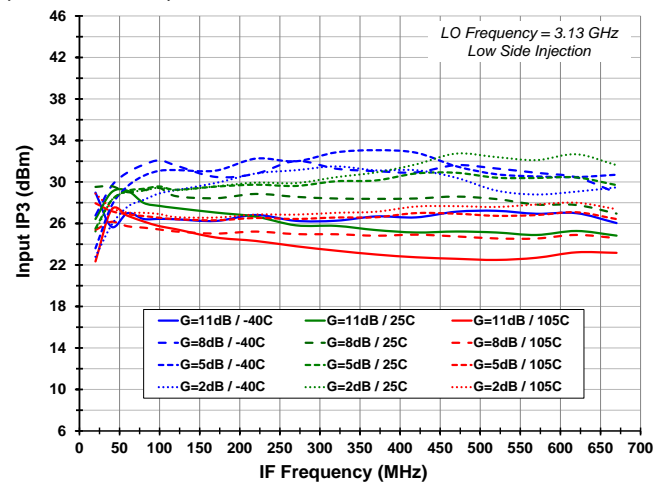

TOCs (-6) Fixed LO = 1.1 GHz, 1.7 GHz, 2.25 GHz, 3.13 GHz – Output IP3

Output IP3 vs. Temperature and Gain Setting
(LO=1.1 GHz)

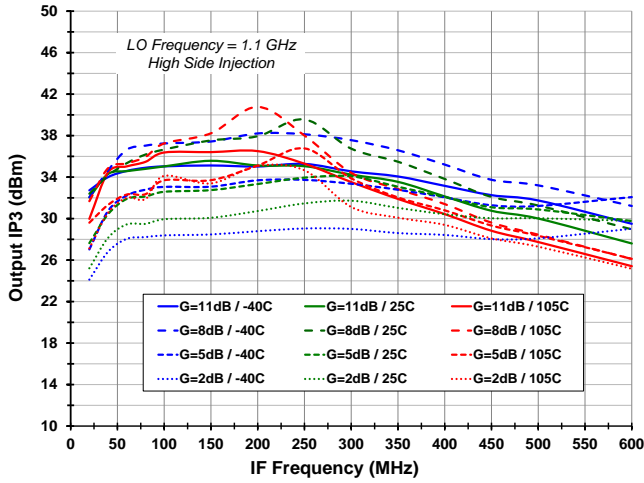

Output IP3 vs. Temperature and Gain Setting
(LO=2.25 GHz)

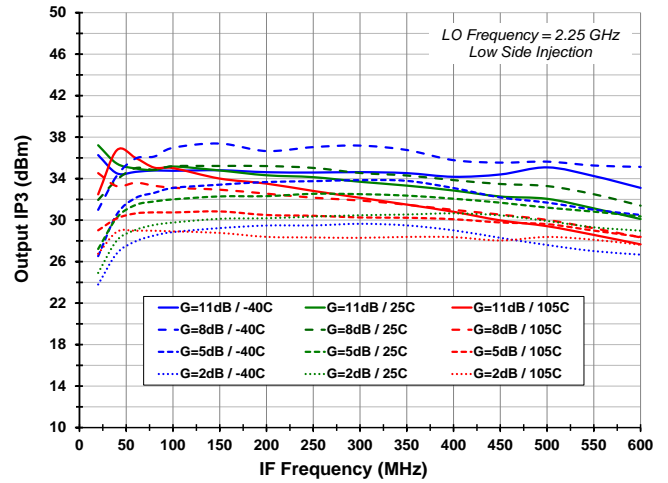

Output IP3 vs. Temperature and Gain Setting
(LO=1.7 GHz)

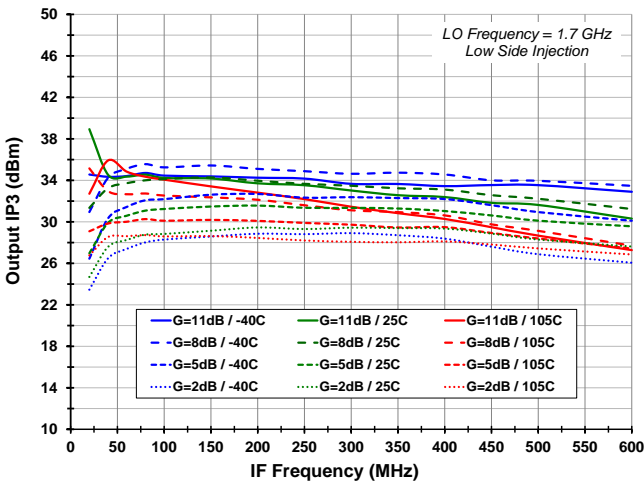

Output IP3 vs. Temperature and Gain Setting
(LO=3.13 GHz)

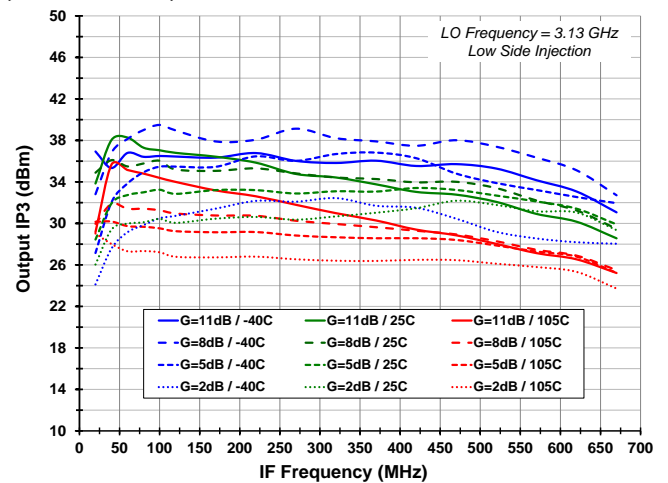

TOCs (-7-) Fixed LO = 1.1 GHz, 1.7 GHz, 2.25 GHz, 3.13 GHz – Gain

Gain vs. Temperature and Gain Setting
(LO=1.1 GHz)

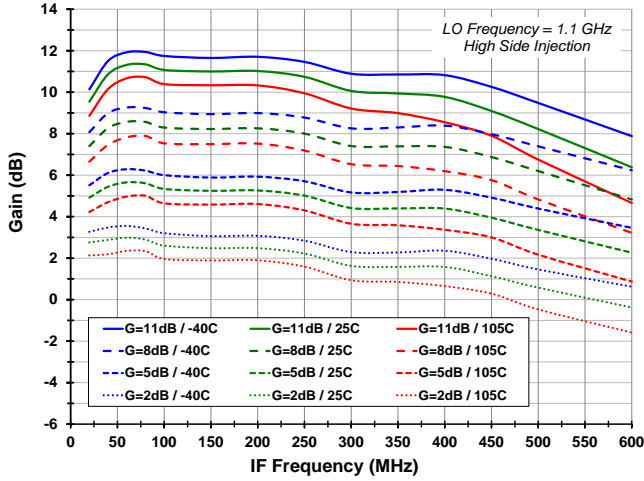

Gain vs. Temperature and Gain Setting
(LO=2.25 GHz)

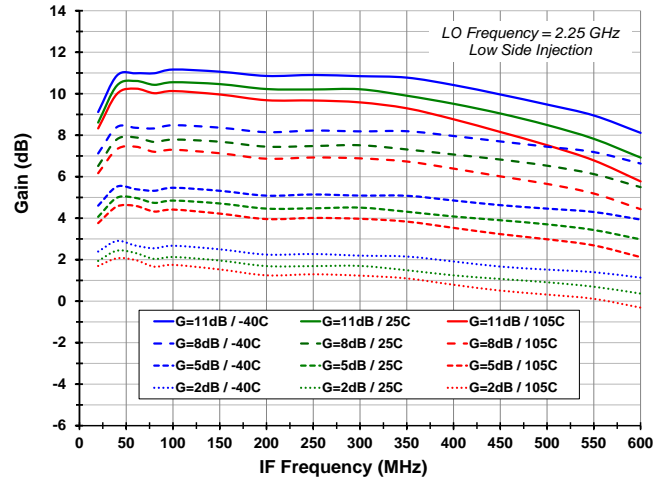

Gain vs. Temperature and Gain Setting
(LO=1.7 GHz)

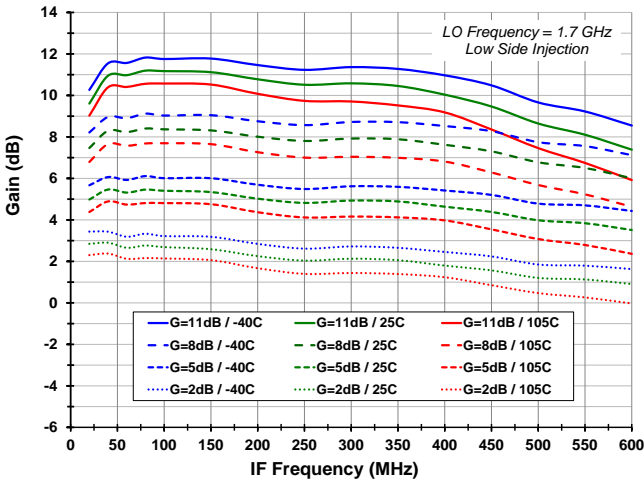

Gain vs. Temperature and Gain Setting
(LO=3.13 GHz)

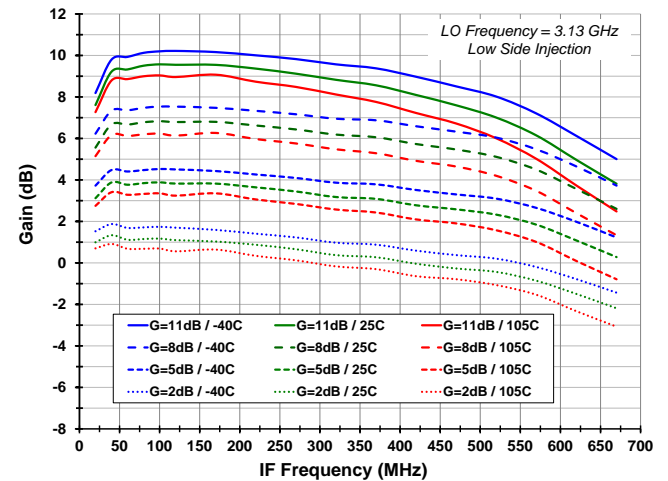

TOCs (-8-) Fixed LO = 1.1 GHz, 1.7 GHz, 2.25 GHz, 3.13 GHz – Input P1dB

Input P1dB vs. Temperature and Gain Setting (LO=1.1 GHz)

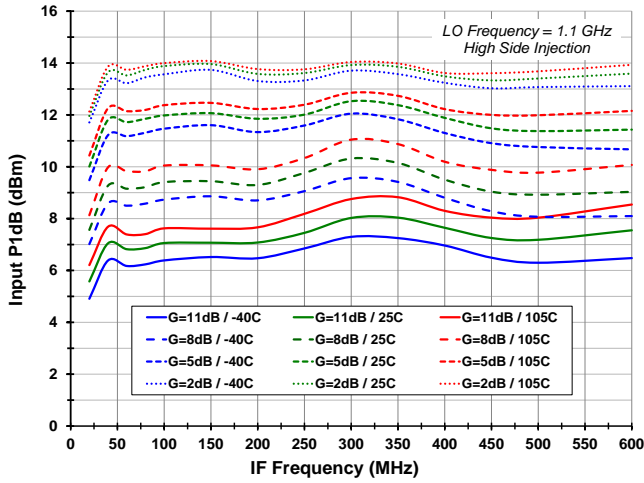

Input P1dB vs. Temperature and Gain Setting (LO=2.25 GHz)

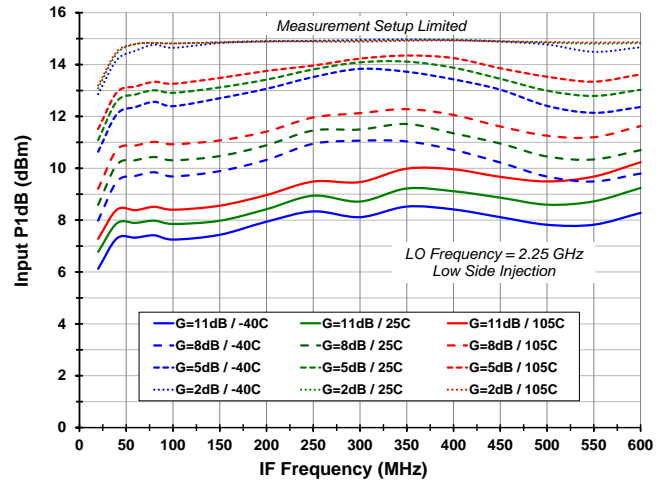

Input P1dB vs. Temperature and Gain Setting (LO=1.7 GHz)

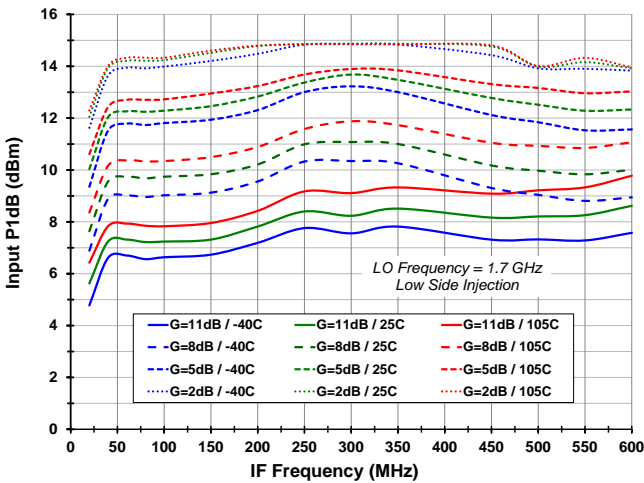

Input P1dB vs. Temperature and Gain Setting (LO=3.13 GHz)

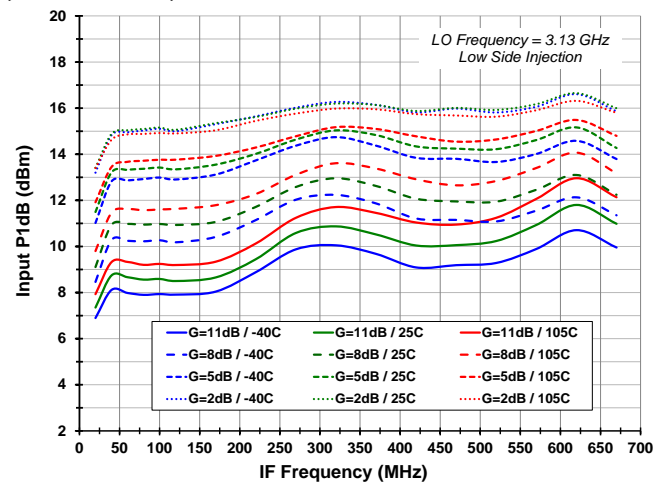

TOCs (-9-) Fixed LO = 1.1 GHz, 1.7 GHz, 2.25 GHz, 3.13 GHz – 2x2 Rejection

2x2 Rejection vs. Temperature and Gain Setting (LO=1.1 GHz)

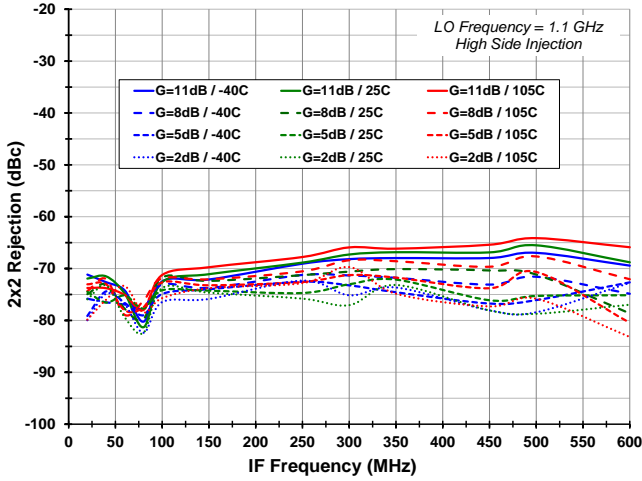

2x2 Rejection vs. Temperature and Gain Setting (LO=2.25 GHz)

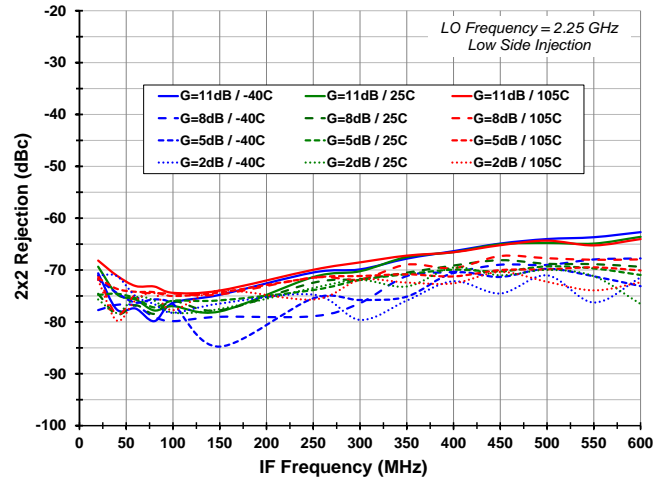

2x2 Rejection vs. Temperature and Gain Setting (LO=1.7 GHz)

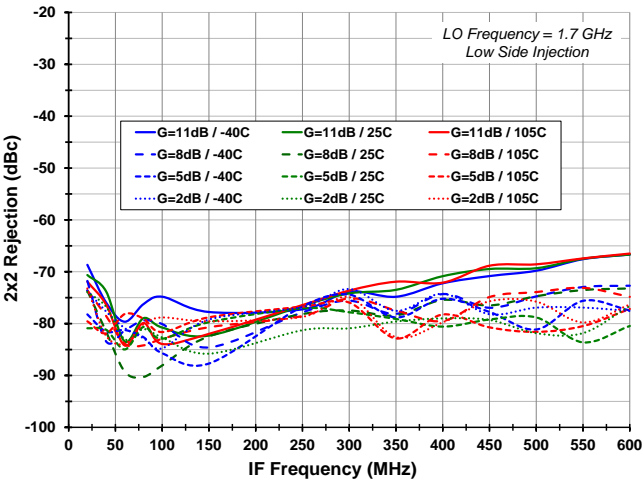

2x2 Rejection vs. Temperature and Gain Setting (LO=3.13 GHz)

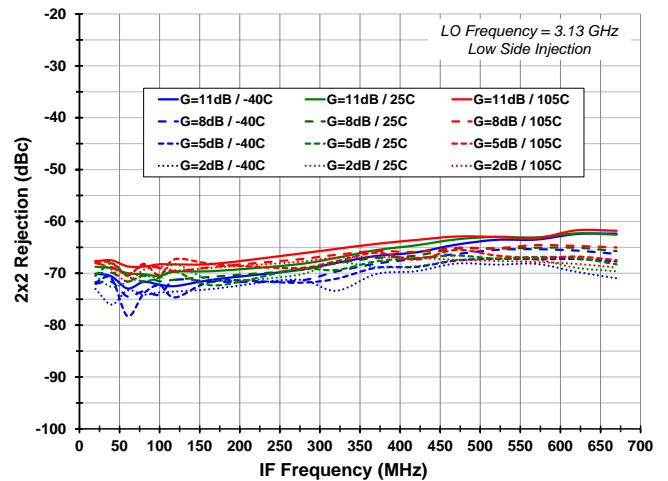

TOCs (-10-) Fixed LO = 1.1 GHz, 1.7 GHz, 2.25 GHz, 3.13 GHz – 3x3 Rejection

3x3 Rejection vs. Temperature and Gain Setting (LO=1.1 GHz)

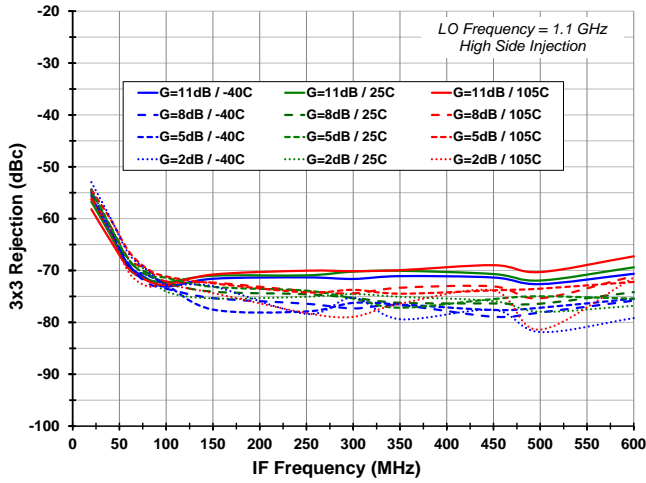

3x3 Rejection vs. Temperature and Gain Setting (LO=2.25 GHz)

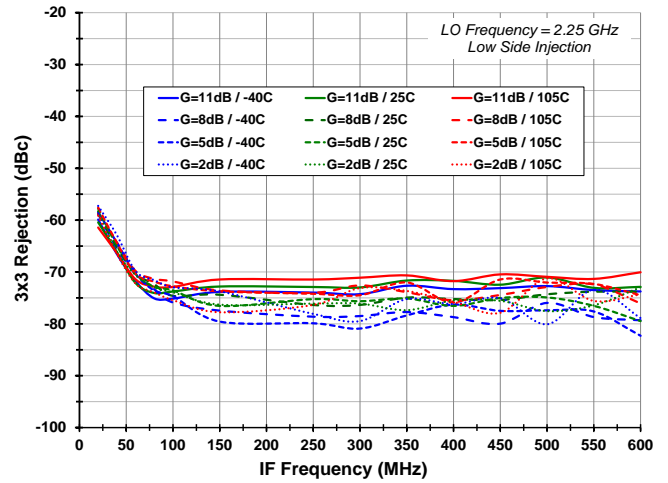

3x3 Rejection vs. Temperature and Gain Setting (LO=1.7 GHz)

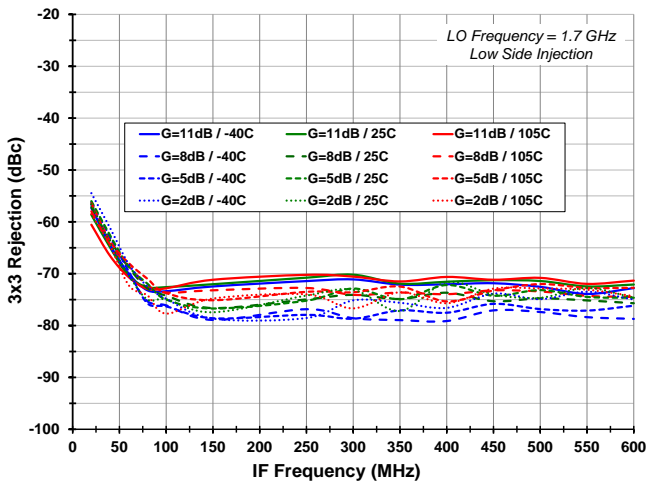

3x3 Rejection vs. Temperature and Gain Setting (LO=3.13 GHz)

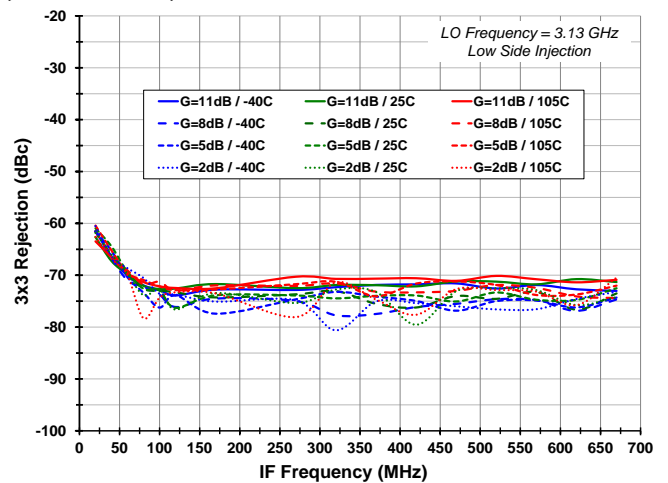

TOCs (-11-) Fixed LO = 1.1 GHz, 1.7 GHz, 2.25 GHz, 3.13 GHz – Output IP2

Output IP2 vs. Temperature and Gain Setting (LO=1.1 GHz)

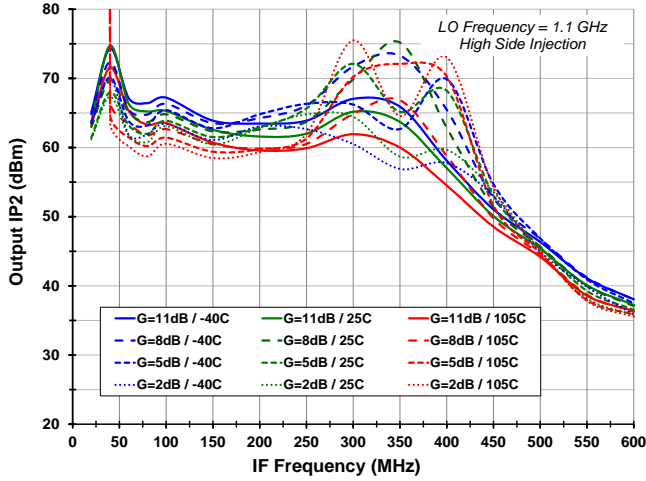

Output IP2 vs. Temperature and Gain Setting (LO=2.25 GHz)

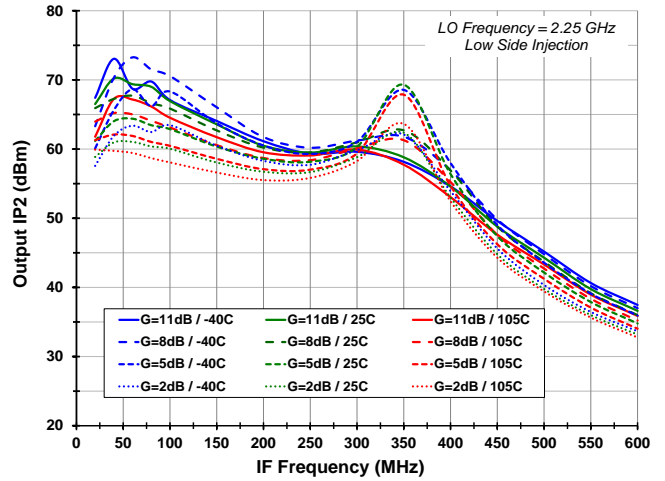

Output IP2 vs. Temperature and Gain Setting (LO=1.7 GHz)

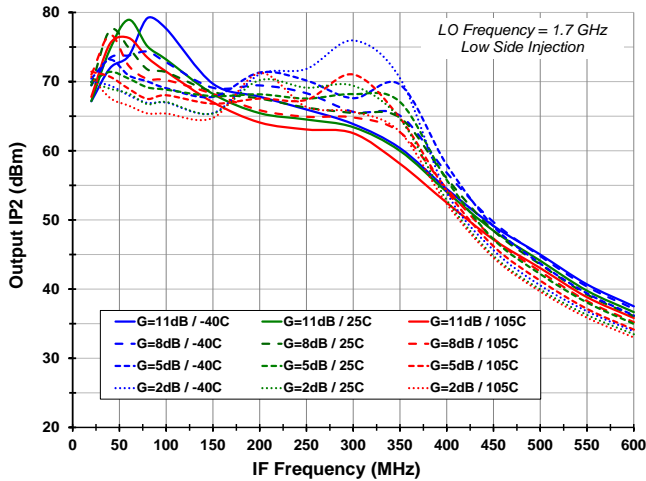

Output IP2 vs. Temperature and Gain Setting (LO=3.13 GHz)

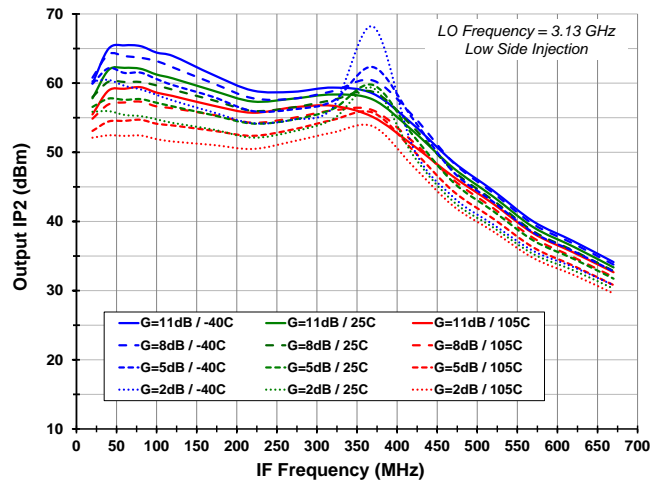

TOCs (-12-) Return Losses, Evaluation Kit Losses, STBY Settling Time

IF Port Return Loss vs. Gain Setting

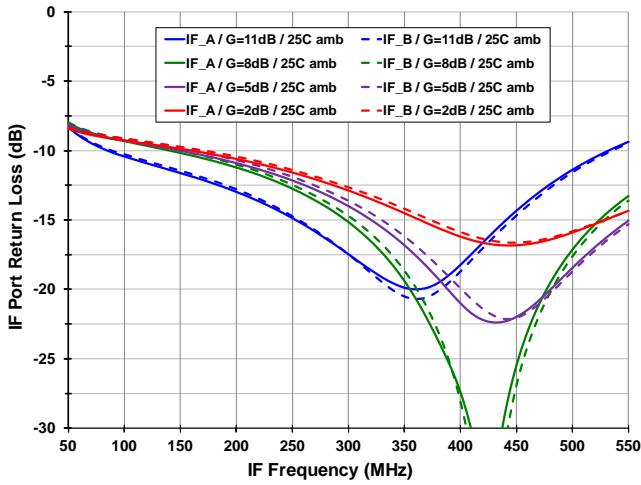

Evaluation Kit IF Transformer Loss vs. Temperature

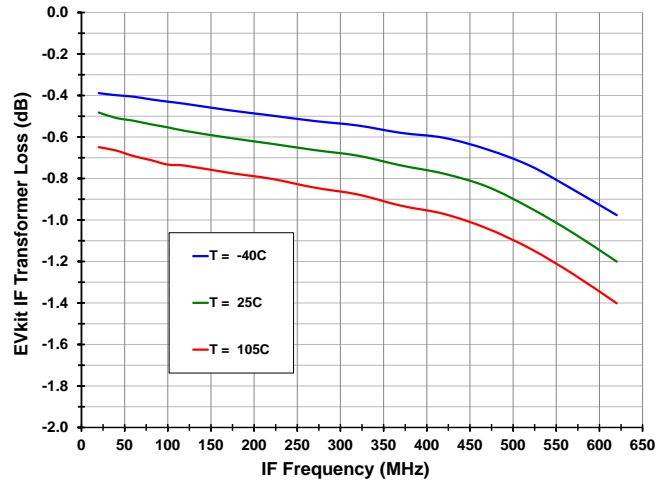

RF Port Return Loss vs. LO Frequency

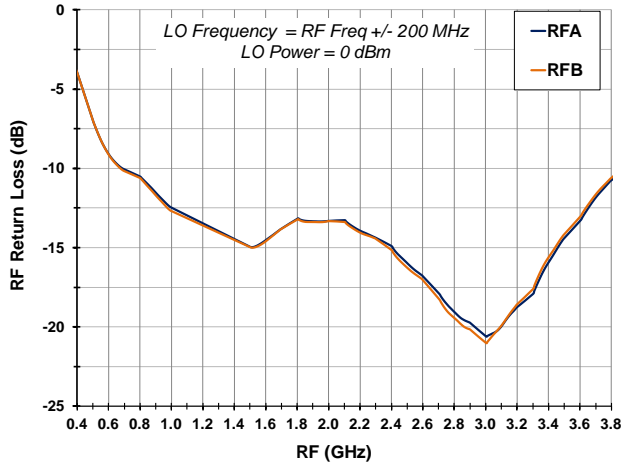

Evaluation Kit RF Trace Loss vs. Temperature

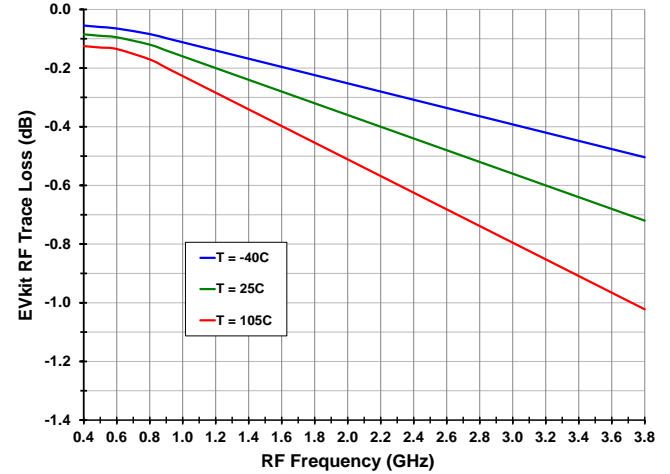

LO Port Return Loss vs. LO Power Level

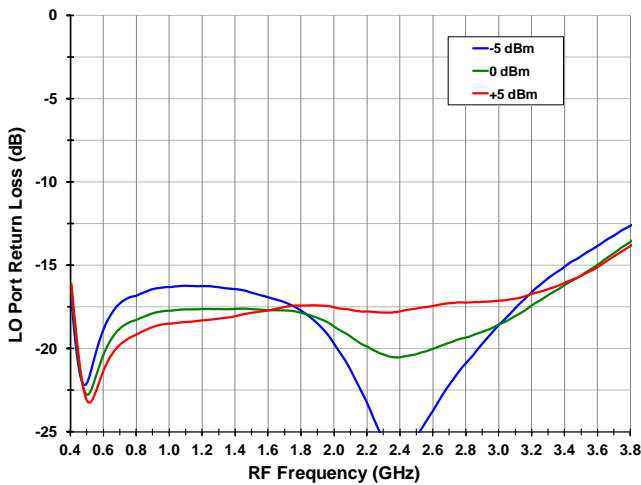

STBY Settling Time

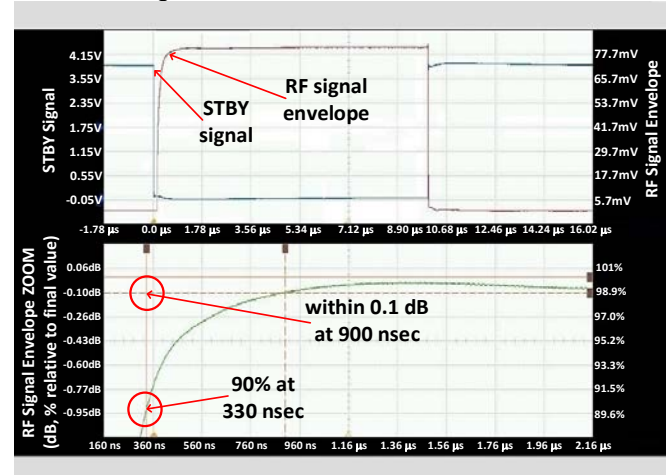

TOCs (-13-) Gain Settling Time

Gain Settling Time for 11 dB to 8 dB Gain Setting

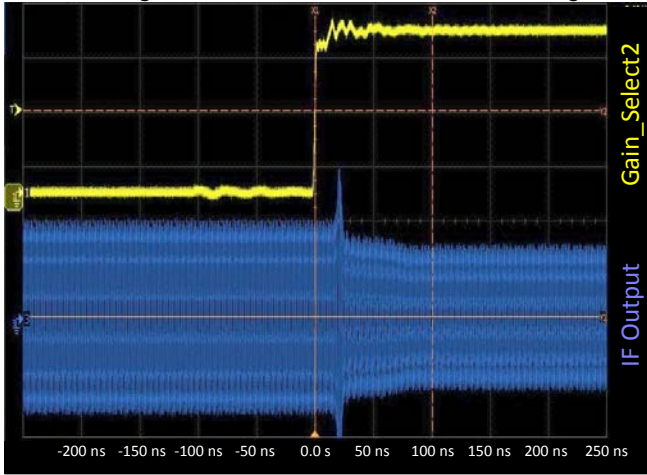

Gain Settling Time for 5 dB to 8 dB Gain Setting

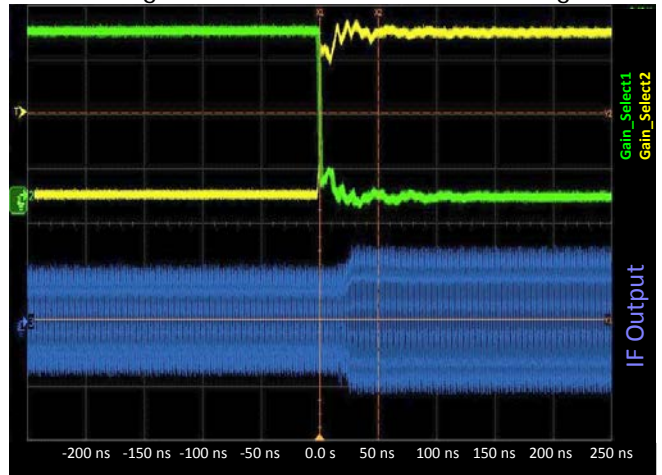

Gain Settling Time for 8 dB to 11 dB Gain Setting

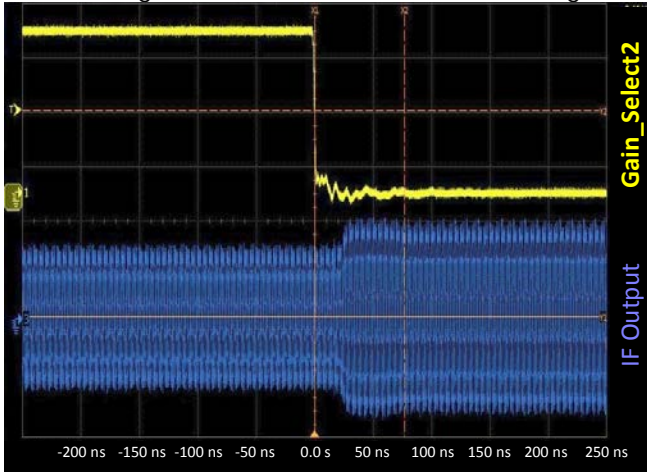

Gain Settling Time for 5 dB to 2 dB Gain Setting

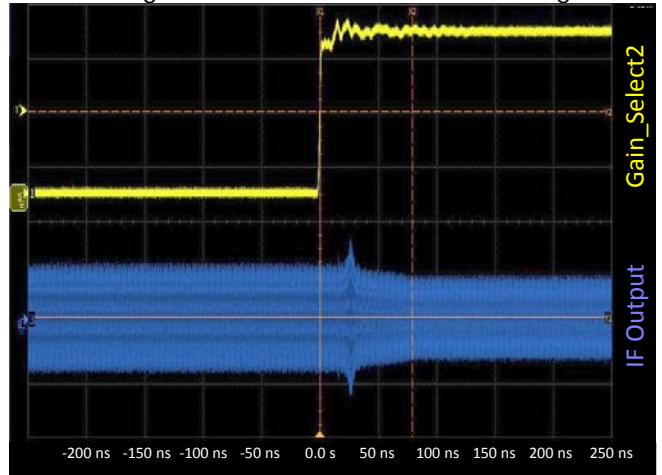

Gain Settling Time for 8 dB to 5 dB Gain Setting

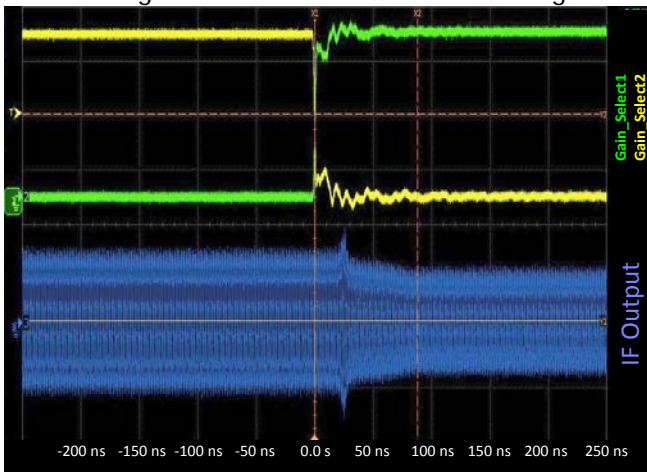

Gain Settling Time for 2 dB to 5 dB Gain Setting

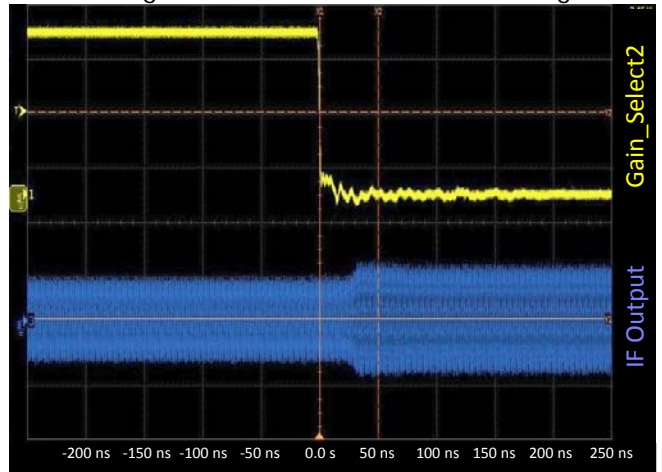

PACKAGE DRAWING

(4mm x 4mm 24-pin TQFN) with EPAD Option P1

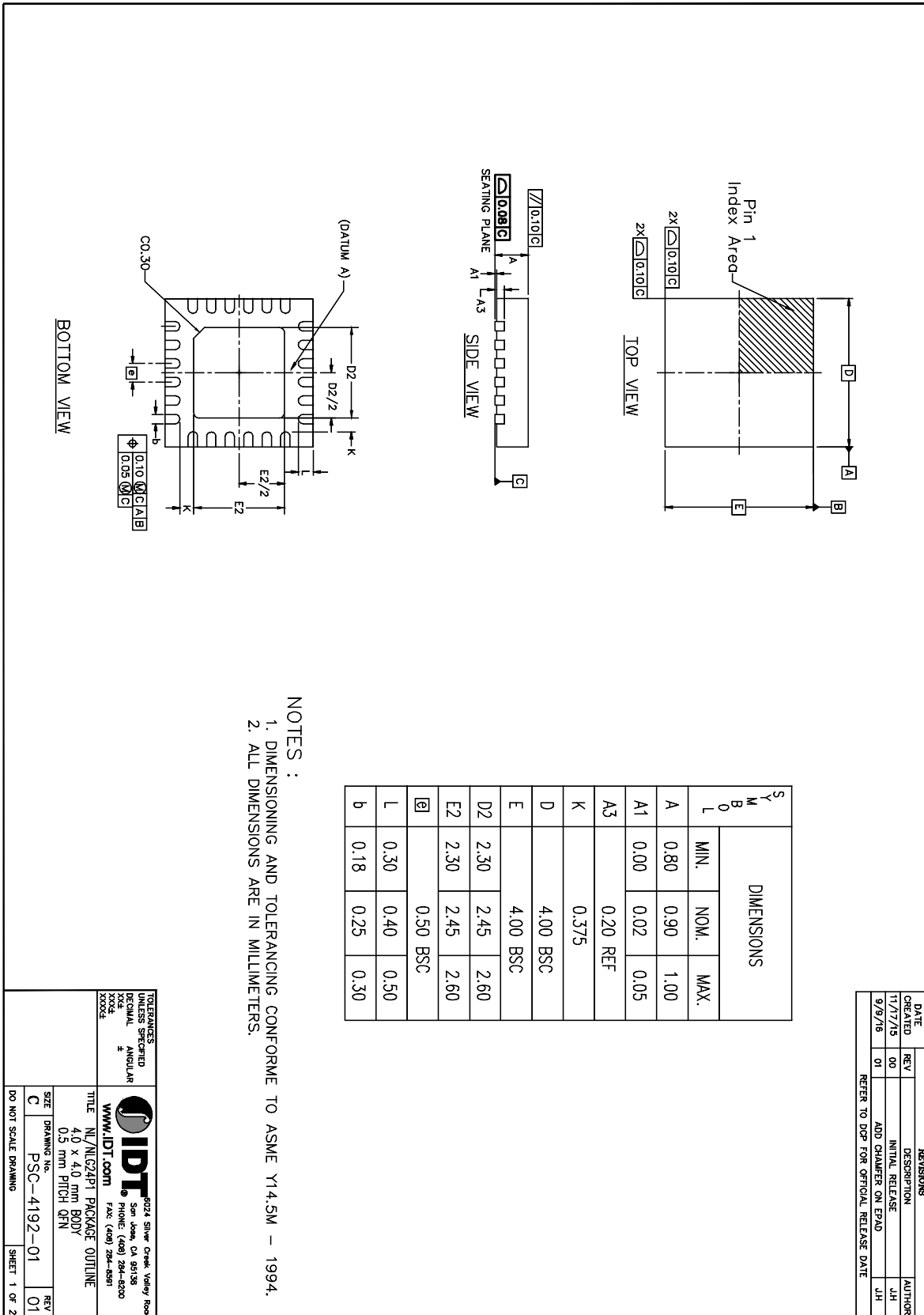

LAND PATTERN

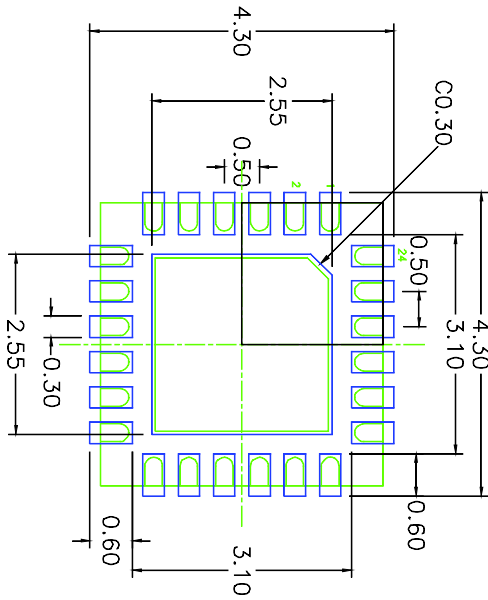

RECOMMENDED LAND PATTERN DIMENSION

- NOTES:
1. ALL DIMENSIONS ARE IN MM. ANGLES IN DEGREES.
 2. TOP DOWN VIEW, AS VIEWED ON PCB.
 3. COMPONENT OUTLINE SHOWS FOR REFERENCE IN GREEN.
 4. LAND PATTERN IN BLUE. NSMD PATTERN ASSUMED.
 5. LAND PATTERN RECOMMENDATION PER IPC-7351B GENERIC REQUIREMENT FOR SURFACE MOUNT DESIGN AND LAND PATTERN.

DATE		REVISIONS		AUTHOR
CREATED	REV	DESCRIPTION		
11/17/15	00	INITIAL RELEASE		JH
9/9/16	01	ADD CHAMFER ON EPAD		JH

REFER TO DCP FOR OFFICIAL RELEASE DATE

UNLESS SPECIFIED DIMENSIONAL SYSTEM IS METRIC UNLESS OTHERWISE INDICATED	024 Silver Creek Valley Road San Jose, CA 95128 Phone: (408) 284-8000 Fax: (408) 284-8599
TITLE N/N1624P1 PACKAGE OUTLINE SIZE 4.0 x 4.0 mm BODY 0.5 mm PITCH QFN	IDT WWW.IDT.COM
DRAWING No. PSC-4192-01	REV 01
DO NOT SCALE DRAWING	SHEET 2 OF 2

PIN DIAGRAM

Red denotes internal connection

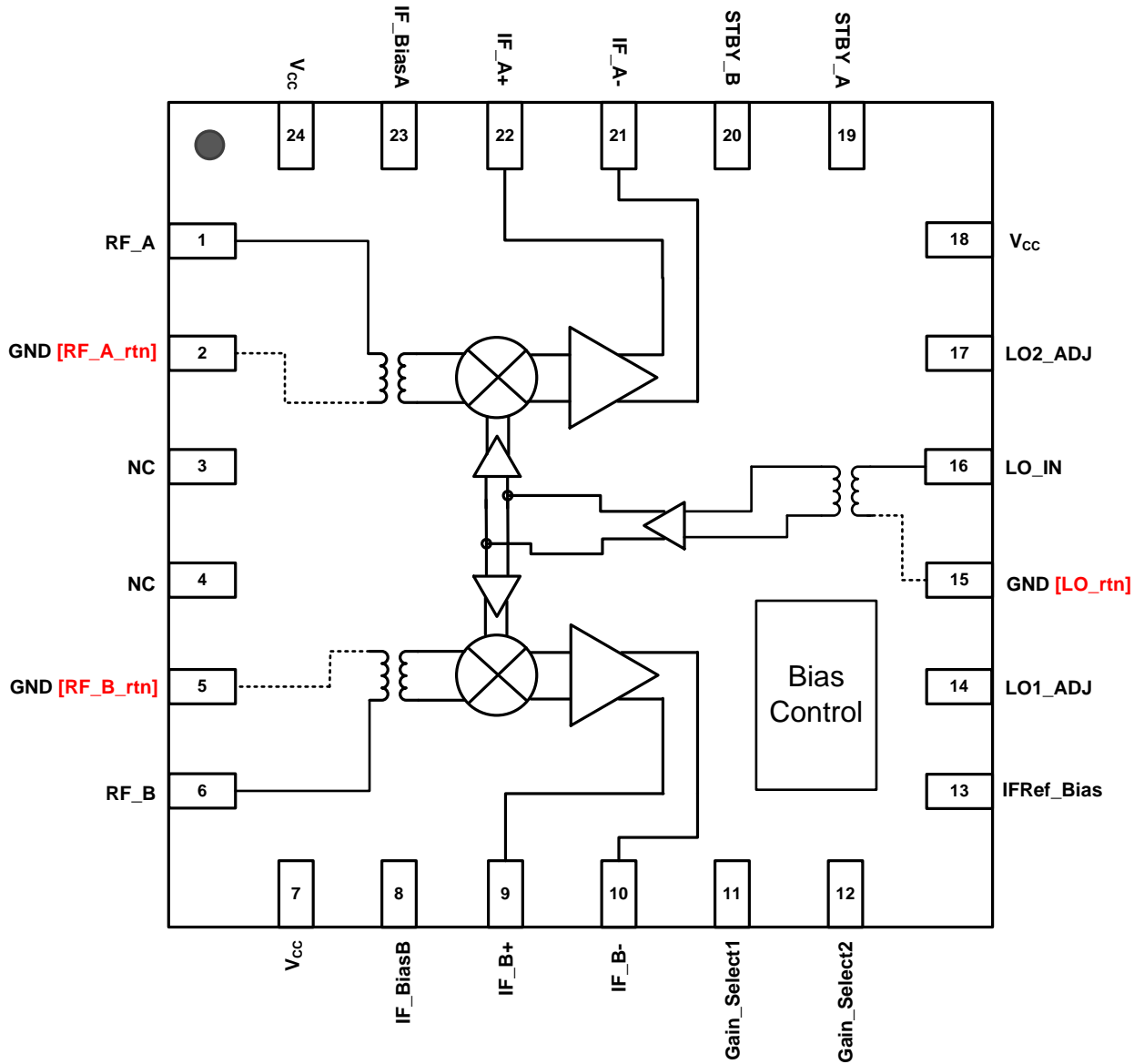

PIN DESCRIPTION

Pin	Name	Function
1	RF_A	Main Channel RF Input. Matched to 50 ohms. DO NOT apply DC to this pin.
2, 5, 15	RF_A_rtn, RF_B_rtn, LO_rtn	Transformer Ground Returns. Ground these pins.
3, 4	N.C.	Not Connected
6	RF_B	Diversity Channel RF Input. Matched to 50 ohms. DO NOT apply DC to this pin.
7, 18, 24	VCC	Power Supply. Bypass to GND with capacitors shown in the Typical Application Circuit as close as possible to pin.
8	IF_BiasB	Connect the specified resistor from this pin to ground to set the bias for the Diversity IF amplifier.
9, 10	IFB+, IFB-	Diversity Mixer Differential IF Output. Connect pullup inductors from each of these pins to VCC (see the Typical Application Circuit).
11	Gain_Select1	Gain select control pin logic includes internal pull-down resistor. See gain select truth table for desired setting
12	Gain_Select2	Gain select control pin logic includes internal pull-down resistor. See gain select truth table for desired setting
13	IFRef_Bias	Connect the specified resistor from this pin to ground to set the IF amplifier reference current.
14	LO1_ADJ	Connect 0 ohm resistor to GND for best performance.
16	LO_IN	Local Oscillator Input. DO NOT apply DC to this pin.
17	LO2_ADJ	Connect 0 ohm resistor to GND for best performance.
19	STBY_A	Standby Channel A (Low/Open = Channel A power ON, High = Channel A power OFF). Includes internal pull-down resistor.
20	STBY_B	Standby Channel B (Low/Open = Channel B power ON, High = Channel B power OFF). Includes internal pull-down resistor.
21, 22	IFA-, IFA+	Main Mixer Differential IF Output. Connect pullup inductors from each of these pins to VCC (see the Typical Application Circuit).
23	IF_BiasA	Connect the specified resistor from this pin to ground to set the bias for the Main IF amplifier.
	— EP	Exposed Pad. Internally connected to GND. Solder this exposed pad to a PCB pad that uses multiple ground vias to provide heat transfer out of the device into the PCB ground planes. These multiple via grounds are also required to achieve the specified RF performance.

EvKIT PICTURE

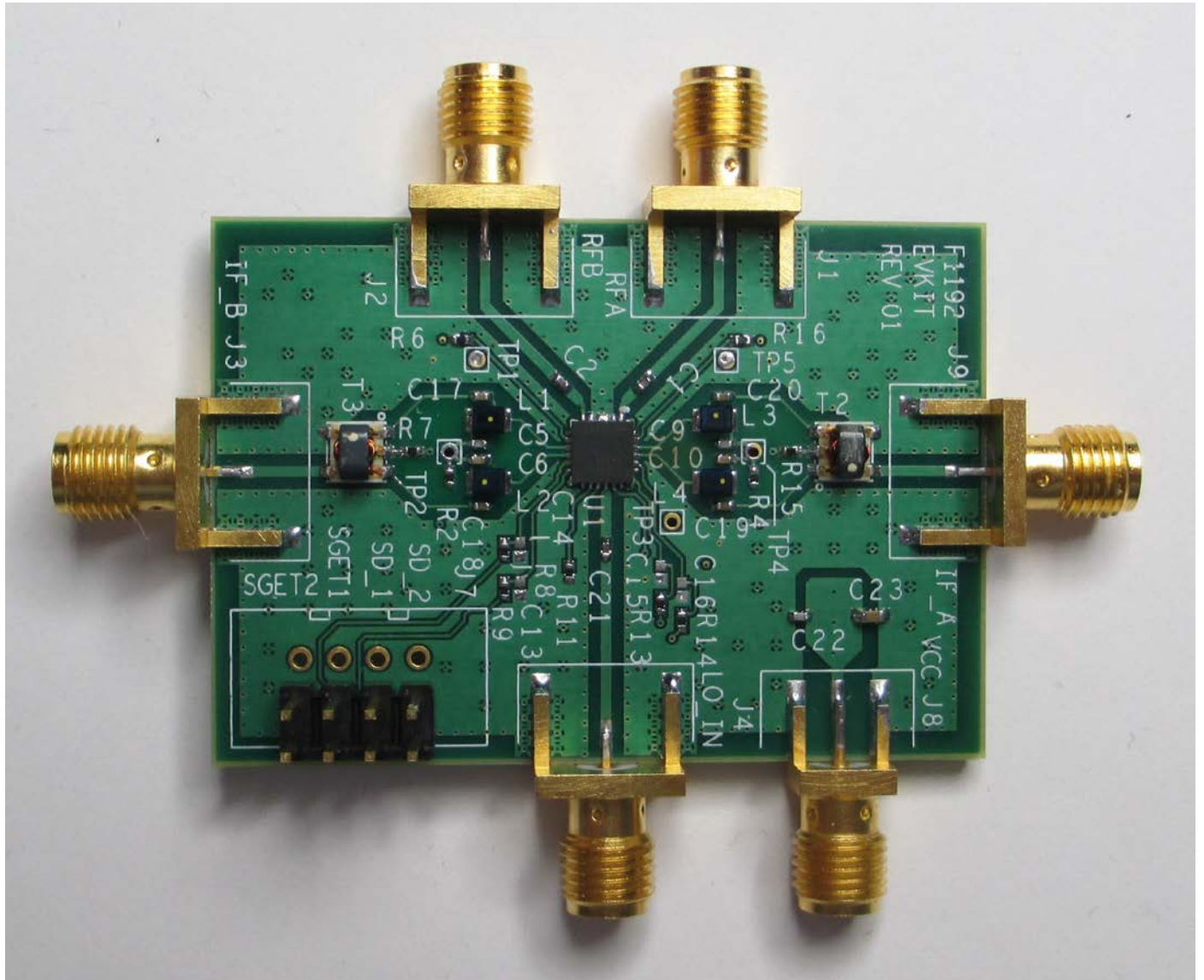

EVKIT / APPLICATIONS CIRCUIT

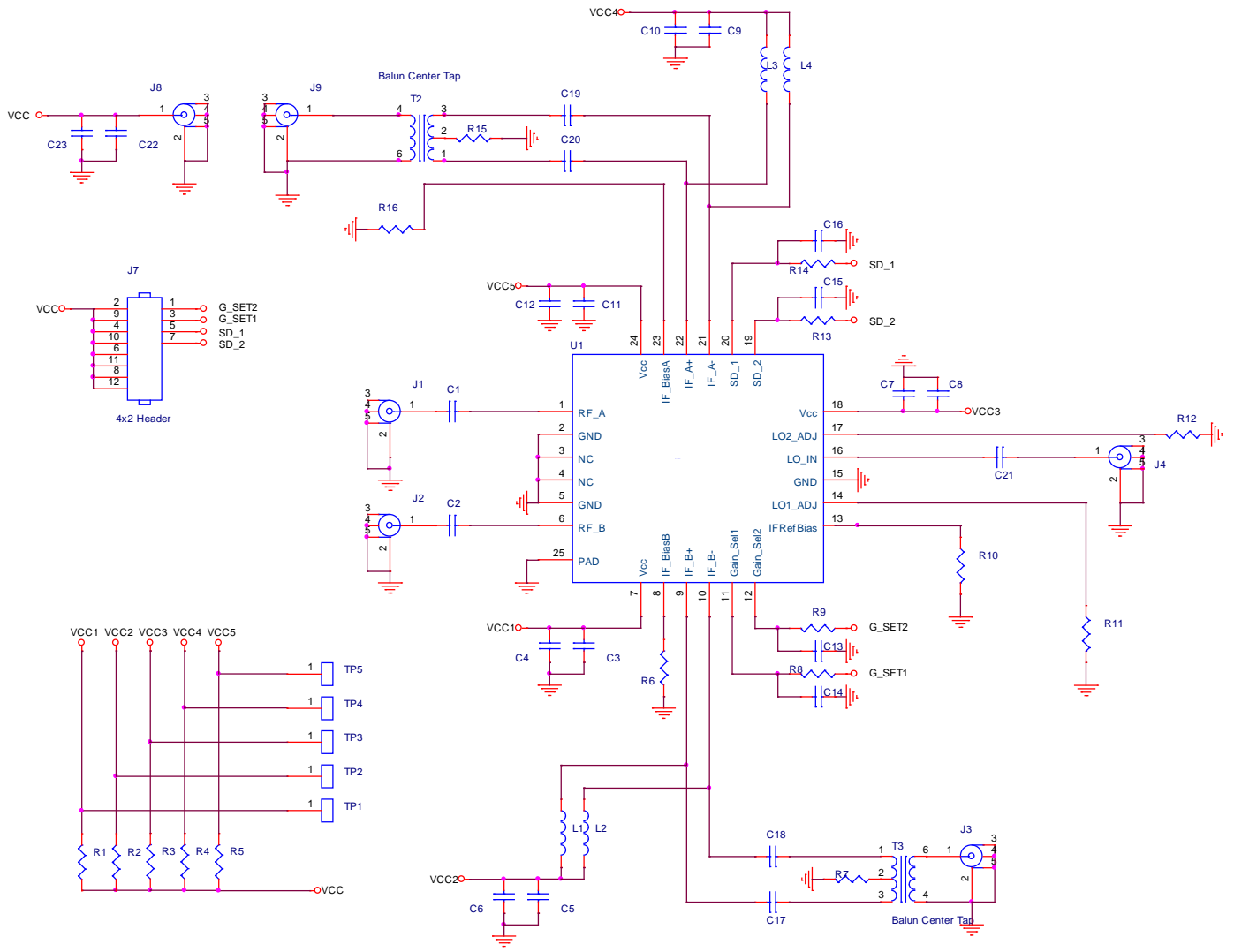

EVKIT BOM

Part Reference	QTY	DESCRIPTION	Mfr. Part #	Mfr.
C3, C5, C7, C9, C11, C22	6	1000pF ±5%, 50V, COG Ceramic Capacitor (0402)	GRM1555C1H102J	Murata
C4, C6, C8, C10, C12, C17-C20, C23	10	10,000pF ±10%, 50V, X7R Ceramic Capacitor (0603)	GRM188R71H103KA01D	Murata
C21	1	1000pF ±5%, 50V, COG Ceramic Capacitor (0402)	GRM1555C1H102J	Murata
C1, C2	2	39pF ±5%. 5V, COG Ceramic Capacitor (0402)	GRM1555C1H390J	Murata
R1-R5, R7, R8, R9, R11, R12, R13, R14, R15	13	0 Ohm, 1/10W, Resistor (0402)	ERJ-2GE0R00X	Panasonic
R6, R16	2	390 Ohm ±1%, 1/10W, Resistor (0402)	ERJ-2RKF3900X	Panasonic
R10	1	1.74 kOhm ±1%, 1/10W, Resistor (0402)	ERJ-2RKF1741X	Panasonic
L1-4	4	390nH ±5%, 0.29 A, Ceramic Chip Inductor (0805)	0805CS-391XJL	Coilcraft
T1-T2	2	4:1 Center Tap Balun	TC4-6TG2+	Mini-Circuits
J7	1	CONN HEADER VERT DBL 4POS GOLD	67997-108HLF	FCI
J2-J6	3	Edge Launch SMA Connector (Big)	142-0701-851	Emerson Johnson
J1	1	Edge Launch SMA Connector (Small)	142-0711-821	Emerson Johnson
U1	1	RF Dual Wideband Gain-Settable Downconverting Mixer 4x4 TQFN24	F1192BNLGK	IDT
	1	Printed Circuit Board	F1192 EVKIT REV 01	IDT

APPLICATIONS INFORMATION

Power Supplies

A common VCC power supply should be used for all pins requiring DC power. All supply pins should be bypassed with external capacitors to minimize noise and fast transients. Supply noise can degrade noise figure and fast transients can trigger ESD clamps and cause them to fail. Supply voltage change or transients should have a slew rate smaller than $1V/20\mu S$. In addition, all control pins should remain at 0V (+/-0.3V) while the supply voltage ramps or while it returns to zero.

Control Pin Interface

If control signal integrity is a concern and clean signals cannot be guaranteed due to overshoot, undershoot, ringing, etc., provisions for an R-C circuit at the input of each control pin is recommended. This applies to pins 11, 12, 19, and 20 as shown below.

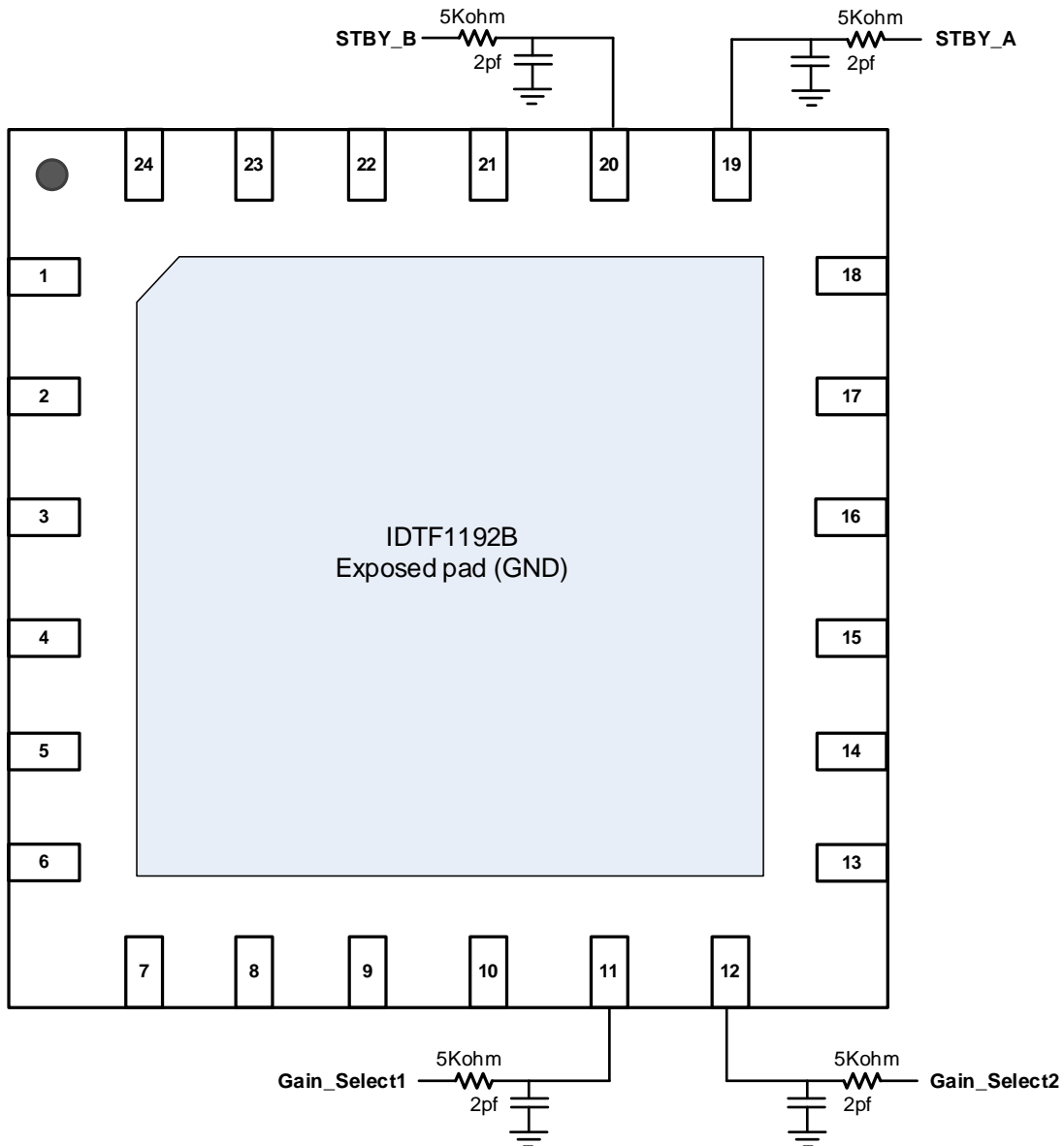

INDEPENDENT CHANNEL STANDBY

F1192B provides an independent path standby feature to reduce power consumption with a dedicated pin for each path. The following table summarizes the required pin logic to achieve the desired standby setting. Internal pull down resistors are included requiring no control to enable both channels.

Channel A	STBY_A Pin 19
ON	0
OFF	1
Channel B	STBY_B Pin 20
ON	0
OFF	1

GAIN SELECT

F1192B provides a gain select feature requiring 2 pins for logic control. The following table summarizes the required pin logic to achieve the desired gain setting. Internal pull down resistors are included requiring no control to set both channels to maximum gain.

Desired Power Gain (dB)	Gain Select1 Pin 11	Gain Select2 Pin 12
11	0	0
8	0	1
5	1	0
2	1	1

DEFAULT START-UP

Upon start-up, the device gain will be whatever the gain select pins are set for as defined in the table above.

Ordering Information

Orderable Part Number	Package	MSL Rating	Shipping Packaging	Temperature
F1192BNLGK	4.0 x 4.0 x 0.90 mm QFN	1	Tray	-40° to +105°C
F1192BNLGK8	4.0 x 4.0 x 0.90 mm QFN	1	Tape and Reel	-40° to +105°C
F1192BEVBI	Evaluation Board			

Marking Diagram

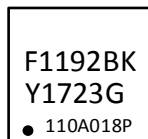

1. Line 1 is the part number.
2. Line 2 "Y" is for die version.
3. Line 2 "1723" = yyww has two digits for the year and week the part was assembled.
4. Line 2 "G" denotes Assembly Site.
5. Line 3 "110A018P" is the Assembly Lot number.

REVISION HISTORY SHEET

Rev	Date	Description of Change
0	August 29, 2017	Initial release.

IMPORTANT NOTICE AND DISCLAIMER

RENESAS ELECTRONICS CORPORATION AND ITS SUBSIDIARIES (“RENESAS”) PROVIDES TECHNICAL SPECIFICATIONS AND RELIABILITY DATA (INCLUDING DATASHEETS), DESIGN RESOURCES (INCLUDING REFERENCE DESIGNS), APPLICATION OR OTHER DESIGN ADVICE, WEB TOOLS, SAFETY INFORMATION, AND OTHER RESOURCES “AS IS” AND WITH ALL FAULTS, AND DISCLAIMS ALL WARRANTIES, EXPRESS OR IMPLIED, INCLUDING, WITHOUT LIMITATION, ANY IMPLIED WARRANTIES OF MERCHANTABILITY, FITNESS FOR A PARTICULAR PURPOSE, OR NON-INFRINGEMENT OF THIRD PARTY INTELLECTUAL PROPERTY RIGHTS.

These resources are intended for developers skilled in the art designing with Renesas products. You are solely responsible for (1) selecting the appropriate products for your application, (2) designing, validating, and testing your application, and (3) ensuring your application meets applicable standards, and any other safety, security, or other requirements. These resources are subject to change without notice. Renesas grants you permission to use these resources only for development of an application that uses Renesas products. Other reproduction or use of these resources is strictly prohibited. No license is granted to any other Renesas intellectual property or to any third party intellectual property. Renesas disclaims responsibility for, and you will fully indemnify Renesas and its representatives against, any claims, damages, costs, losses, or liabilities arising out of your use of these resources. Renesas' products are provided only subject to Renesas' Terms and Conditions of Sale or other applicable terms agreed to in writing. No use of any Renesas resources expands or otherwise alters any applicable warranties or warranty disclaimers for these products.

(Rev.1.0 Mar 2020)

Corporate Headquarters

TOYOSU FORESIA, 3-2-24 Toyosu,
Koto-ku, Tokyo 135-0061, Japan
www.renesas.com

Contact Information

For further information on a product, technology, the most up-to-date version of a document, or your nearest sales office, please visit:
www.renesas.com/contact/

Trademarks

Renesas and the Renesas logo are trademarks of Renesas Electronics Corporation. All trademarks and registered trademarks are the property of their respective owners.

X-ON Electronics

Largest Supplier of Electrical and Electronic Components

Click to view similar products for [RF Mixer](#) category:

Click to view products by [Renesas](#) manufacturer:

Other Similar products are found below :

[HMC337-SX](#) [HMC404-SX](#) [mamx-009646-23dbml](#) [HMC339-SX](#) [HMC8192-SX](#) [MIQ24MS-2](#) [HMC220BMS8GETR](#) [M85C](#) [HMC554A-SX](#)
[HMC8192LG](#) [HMC521A-SX](#) [HMC521ACHIPS](#) [CMD258C4](#) [LT5511EFE](#) [MAMX-011023-SMB](#) [HMC399MS8TR](#) [HMC333TR](#)
[HMC214MS8TR](#) [HMC175MS8TR](#) [MAMXSS0012TR-3000](#) [109728-HMC129LC4](#) [CSM1-13](#) [SA612AD/01.112](#) [HMC785LP4ETR](#)
[LT5579IUH#PBF](#) [HMC773ALC3BTR](#) [HMC558ALC3B](#) [HMC329ALC3B](#) [MY63H](#) [AD8343ARUZ-REEL7](#) [AD608AR](#) [AD608ARZ](#)
[AD831APZ](#) [AD831APZ-REEL7](#) [AD8342ACPZ-REEL7](#) [AD8343ARUZ](#) [AD8344ACPZ-REEL7](#) [ADL5350ACPZ-R7](#) [ADL5363ACPZ-R7](#)
[ADL5365ACPZ-R7](#) [ADL5801ACPZ-R7](#) [ADL5802ACPZ-R7](#) [HMC1056LP4BE](#) [HMC1057-SX](#) [HMC1063LP3E](#) [HMC1093-SX](#) [HMC1106-](#)
[SX](#) [HMC129](#) [HMC143](#) [HMC400MS8ETR](#)