

## GENERAL DESCRIPTION

This document describes the specification for the IDTF1358 Digital Pre-Distortion Demodulator for PA linearization. This series of devices is offered in 3 variants to cover common UTRA bands.

## COMPETITIVE ADVANTAGE

In typical basestation transmitters, digital pre-distortion is employed to improve the Transmitter performance. The signal coming out of the PA is sampled and the incoming Tx chain I&Q data is pre-distorted to counteract the distortion inherent in the PA. The PA signal is adjusted via a digital step attenuator to a lower level and then sub-sampled at an IF frequency of ~200 MHz which necessitates the need for a highly linear demodulator to downmix to quadrature IF from the Transmit frequency. By sampling IF\_I and IF\_Q independently and then digitally combining these signals, an effective doubling of the sample rate can be achieved. Any distortion in this path will degrade the performance of the DPD algorithm. By utilizing an ultra-linear demodulator w/integrated DSA such as the IDTF1358, the ACLR and/or power consumption of the full Tx system can be improved significantly.

- ✓ GlitchFree™ Technology gives better gain control
- ✓ Zero-Distortion™ eliminates the need for a second IF amplifier in the channel
- ✓ ACLR is reduced for the full channel
- ✓ Power Consumption is reduced by 40%
- ✓ Integrates 2 BPFs, 2 Baluns, and a SPDT RF switch

## FEATURES

- Wide flat performance IF BW
- Wide RF and LO BWs (~ 800 MHz)
- LO can be High or Low Side
- Ideal for Multi-Carrier Systems
- Drives ADC directly
- Ultra linear +41 dBm OIP3
- Excellent ACLR performance
- 200 Ω output impedance
- Fully integrated DPD demodulator
- Standby Mode w/Fast Recovery
- Current draw is 216 mA
- 6 x 6 mm 36 pin package

## FUNCTION BLOCK DIAGRAM

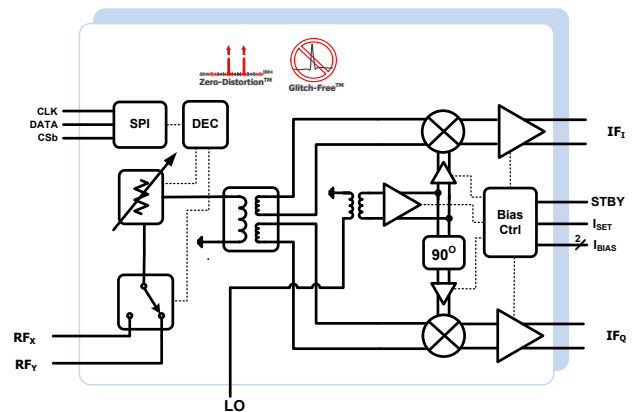

## ORDERING INFORMATION

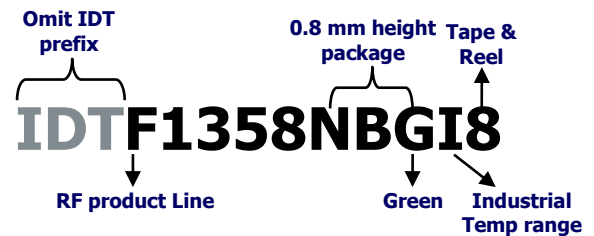

## ABSOLUTE MAXIMUM RATINGS

Parameter	Symbol	Min	Max	Units
V <sub>CC</sub> to GND	V <sub>CC</sub>	-0.3	+5.5	V
DATA,CSb, CLK, SW_Latch	V <sub>Logic</sub>	0.0	3.6	V
STBY	V <sub>Logic-Stby</sub>	0.0	V <sub>CC</sub>	
IF_I+, IF_I-, IF_Q+, IF_Q-,	I <sub>IF</sub>	1.00	V <sub>CC</sub> + 0.30	V
RF_INX, RF_INY	V <sub>RF</sub>	-0.3	+0.30	V
LO_IN	V <sub>LO</sub>	-0.3	+0.30	V
LO_ADJ to Ground	V <sub>LObias</sub>	+2.1	+4.0	V
IF_BiasI, IF_BiasQ to Ground	V <sub>IFbias</sub>	-0.3	+1.20	V
Maximum RF Input Power (RFIN_X, RFIN_Y)	P <sub>RFIN</sub>		+27	dBm
Continuous Power Dissipation	P <sub>diss</sub>		2.5	W
Junction Temperature	T <sub>j</sub>		150	°C
Storage Temperature Range	T <sub>st</sub>	-65	150	°C
Lead Temperature (soldering, 10s)			260	°C
ElectroStatic Discharge – HBM (JEDEC/ESDA JS-001-2012)			1000 (Class 1C)	Volts
ElectroStatic Discharge – CDM (JEDEC 22-C101F)			500 (Class C4)	Volts

Stresses above those listed above may cause permanent damage to the device. Functional operation of the device at these or any other conditions above those indicated in the operational section of this specification is not implied. Exposure to absolute maximum rating conditions for extended periods may affect device reliability.

### ESD CAUTION

This product features proprietary protection circuitry. However, it may be damaged if subjected to high energy ESD. Please use proper ESD precautions when handling to avoid damage or loss of performance.



### PACKAGE THERMAL AND MOISTURE CHARACTERISTICS

$\theta_{JA}$ (Junction – Ambient)	40 °C/W
$\theta_{JC}$ (Junction – Case) [The Case is defined as the exposed paddle]	3 °C/W
Moisture Sensitivity Rating (Per J-STD-020)	MSL1

## F1358 RECOMMENDED OPERATING CONDITIONS

Parameter	Symbol	Conditions	Min	Typ	Max	Unit
Supply Voltage(s)	$V_{CC}$	All VCC pins	4.75	5.00	5.25	V
Operating Temperature Range	$T_{CASE}$	Case Temperature	-40		105	°C
RF Freq Range - Linearity	$F_{RF-LIN}$	ATTN = 0 dB $P_{RF} = -11$ dBm/Tone $F_{IF} = 200$ MHz OIP3 > +35 dBm	3200		4000	MHz
RF Freq Range - Oversampled	$F_{RF-OS}$	ATTN = 0 dB RF_INX $F_{LO} = 3180-3500$ MHz Gain Delta < 2.5 dB	3200		4000	MHz
LO Freq Range	$F_{LO}$		3100		3800	MHz
LO Power	$P_{LO}$		-3		3	dBm
IF Freq Range - Linearity	$F_{IF-LIN}$	ATTN = 0 dB RF_INX $P_{RF} = -11$ dBm/Tone $F_{RF} = 3600$ MHz OIP3 > +35 dBm	100		300	MHz
IF Freq Range- Oversampled	$F_{IF-OS}$	ATTN = 0 dB RF_INX $F_{LO} = 3180-3500$ MHz Gain Delta < 2.5 dB	20		500	MHz
RF Source Impedance	$Z_{RF\_INX}$ $Z_{RF\_INY}$	Single Ended		50		$\Omega$
LO Source Impedance	$Z_{LO}$	Single Ended		50		$\Omega$
IF Load Impedance	$Z_{IF\_I}$ $Z_{IF\_O}$	Differential		200		$\Omega$

## F1358 SPECIFICATION

Specifications apply at  $V_{CC} = +5.00$  V,  $T_{CASE} = +25$  °C,  $F_{RF} = 3455$  MHz,  $G_{max}$ ,  $P_{RF} = -11$  dBm,  $F_{LO} = 3255$  MHz,  $P_{LO} = 0$  dBm,  $STBY = GND$ ,  $V_{IH} = 3.3$  V,  $V_{IL} = 0.0$  V unless otherwise noted. Trace, Connector, and external transformer losses are de-embedded.

Parameter	Symbol	Conditions	Min	Typ	Max	Units
Logic Input High	$V_{IH}$	All Control Pins	<b>2</b>			V
Logic Input Low	$V_{IL}$	All Control Pins			<b>0.5</b>	V
Logic Current	$I_{IH}, I_{IL}$	All Control Pins	<b>-130</b>		<b>+10</b>	$\mu$ A
Standby Mode Logic	STBY	STBY = $V_{IH}$	Power OFF			
		STBY = $V_{IL}$	Power ON			
Supply Current	$I_{CC\_ON}$		<b>180</b>	216	<b>250<sup>1</sup></b>	mA
	$I_{CC\_STBY}$	Standby Mode		20	<b>25</b>	
Attenuator Range				25.5		dB
Attenuator Step	LSB			0.5		dB
Gain	$G_{max}$	ATTN = 0 dB	<b>8.7</b>	10.2	<b>11.7</b>	dB
	$G_{min}$	ATTN = 25.5 dB	<b>-16.5</b>	-15	<b>-13.5</b>	
Return Loss, RF ports	$S_{RFX}, S_{RFY}$			16		dB
Return Loss, LO port	$S_{LO}$			15		dB
Return Loss, IF ports	$S_{IFI}, S_{IFI}$	Single Ended		20		dB
Noise Figure	$NF_0$	ATTN = 0 dB		19		dB
Output IP3	$OIP3_0$	ATTN = 0 dB	<b>36</b>	41		dBm
	$OIP3_{20}$	ATTN = 20 dB, $P_{RF} = +9$ dBm		42		
Output IP2	$OIP2_0$	ATTN = 0 dB		59		dBm
Second Harmonic	$H2_0$	ATTN = 0 dB, $P_{IF} = -6$ dBm		-72		dBc
Input Compression	$IP1dB-C_0$	ATTN = 0 dB Gain delta for RF input power set at +5 dBm and RF Input power set at -11 dBm.		0.2	<b>1</b>	dB
Gain Ripple	$G_{ripple}$	$F_{LO} = 3380$ MHz $F_{RF} = 3400$ to 3880 MHz		1.6	$2.5^2$	dB
Group Delay Distortion	GDD	$F_{LO} = 3380$ MHz $F_{RF} = 3400$ to 3880 MHz		5		ns
Attenuator Step Accuracy	DNL			0.2		dB
Absolute Attenuator Accuracy	INL		<b>-0.75</b>	-0.1	<b>0.75</b>	dB

Note 1: Items in min/max columns in **bold italics** are Guaranteed by Test.

Note 2: Items in min/max columns that are not bold/italics are Guaranteed by Design Characterization.

Note 3: Timing measurements are measured after SPI programming is completed (data latched with LE = HIGH).

Note 4: Gain across the entire frequency band is affected by the inclusion of the RF switch.

## F1358 SPECIFICATION

Specifications apply at  $V_{CC} = +5.00\text{ V}$ ,  $T_{CASE} = +25\text{ °C}$ ,  $F_{RF} = 3455\text{ MHz}$ ,  $G_{max}$ ,  $P_{RF} = -11\text{ dBm}$ ,  $F_{LO} = 3255\text{ MHz}$ ,  $P_{LO} = 0\text{ dBm}$ ,  $STBY = GND$ ,  $V_{IH} = 3.3\text{ V}$ ,  $V_{IL} = 0.0\text{ V}$  unless otherwise noted. Trace, Connector, and external transformer losses are de-embedded.

Parameter	Symbol	Conditions	Min	Typ	Max	Units
Quadrature Amplitude Balance	$BAL_G$	Over Oversampled Range	<b>-0.3</b>		<b>0.3</b>	dB
Quadrature Amplitude Balance over environmental	$BAL_{G\Delta}$	$T_{Amb} = -40\text{ to }+85\text{ °C}$ $P_{LO} = -3\text{ to }+3\text{ dBm}$	-0.5		+0.5	dB
Quadrature Phase Balance	$BAL_\phi$		-1	0.3	1.5	degrees
Quadrature Phase Balance over environmental	$BAL_{\phi\Delta}$	$T_{Amb} = -40\text{ to }+85\text{ °C}$ $P_{LO} = -3\text{ to }+3\text{ dBm}$	-1.5	0.5	+2.5	degrees
LO to IF Leakage	$ISO_{LI}$	Output Balun not de-embedded.		-37	-32	dBm
RF to IF Isolation	$ISO_{RI}$	Output Balun not de-embedded. Reference to $P_{IF}$ .		-42	-32	dBc
LO to RF Leakage	$ISO_{LR}$			-41		dBm
RF Switch Isolation	$ISO_{RFX-RXY}$			-40		dB
Switch Time		RF_INX: 3600 MHz, -11 dBm LO: 3415 MHz, 0 dBm 50% CSb to 10%/90% settled to within 0.1dB of final value of power at IF_I.				ns
	$\tau_{EN\_ON}$	EN Bit set high		100		
	$\tau_{EN\_OFF}$	EN Bit set low		50		
	$\tau_{RF\_XY}$	Switched from RF_INX to RF_INY. No power at RF_INY.		150		
DSA Settling time		RF_INX: 3600 MHz, -11 dBm LO: 3415 MHz, 0 dBm 50% CSb to 10%/90% settled to within 0.1dB of final value of power at IF_I.				ns
	$\tau_{SET}$					
	$\tau_{SET1}$	ATTN= 0.0 dB to 25.5 dB		300		
	$\tau_{SET2}$	ATTN= 25.5 dB to 0.0 dB		300		
	$\tau_{SET3}$	ATTN= 15.5 dB to 16.0 dB		250		
	$\tau_{SET4}$	ATTN= 16.0 dB to 15.5 dB		250		
Control Interface	$SPI_{BIT}$			16		bit
Serial Clock Speed	$SPI_{CLK}$			20	<b>50</b>	MHz

Note 1: Items in min/max columns in **bold italics** are Guaranteed by Test.

Note 2: Items in min/max columns that are not bold/italics are Guaranteed by Design Characterization.

Note 3: Timing measurements are measured after SPI programming is completed (data latched with CSb = HIGH).

Note 4: Gain across the entire frequency band is affected by the inclusion of the RF switch.

## POWER-ON SEQUENCE

The power-on sequence will ensure that the F1358 works in the default mode once powered on. If the F1358 is programmed after applying DC power, the following power-on sequence is not needed.

Note: To use power on sequence, SW\_LATCH cannot be grounded permanently.

The power-on sequence should be:

1. CSb & SW\_LATCH must be set low at power-on.
2. Once powered on, first set SW\_LATCH high, then set CSb high.
3. Proceed with normal programming.

The default state after using power-on sequence:

- Maximum attenuation
- RF\_INX selected
- Normal operation (not Standby Mode)

## REGARDING PHASE OF I & Q:

- When LO is high-side injected, IF\_I leads IF\_Q by 90 degrees
- When LO is low-side injected, IF\_Q leads IF\_I by 90 degrees

## OPERATING MODE

There are two hardware pin, STBY on Pin 14 SW\_Latch on Pin 1, which allows multiple operating modes.

**Table 1 - Operating Mode Logic Table**

STBY	SW_Latch	Mode	Write Access	Comment
0	0	Operating Mode	A2,A0 Enabled, D7:D0 Enabled	RF Switch control (A2). Software Standby allowed (A0). Attenuator control (D7:D0).
0	1	Operating Mode	A2,A0 Disabled, D7:D0 Enabled	No RF Switch control. No Software Standby allowed. Attenuator control (D7:D0).
1	0	Off	A2,A0 Enabled, D7:D0 Enabled	RF Switch control (A2). Software Standby allowed (A0). Attenuator control (D7:D0). Device is in Standby mode.
1	1	Off	A2,A0 Disabled, D7:D0 Enabled	No RF Switch control. No Software Standby allowed. Attenuator control (D7:D0). Device is in Standby mode.

## SERIAL CONTROL MODE

Data is clocked in MSB first via serial mode. Serial data is formatted as a 16-bit word. The 16-bit word contains logic for switching the RF switch, 6-bit attenuator setting, and Enabling (software standby). Each word contains the following sequence:

**Table 2 - 16 Bit SPI Word Sequence**

A7	Reserved
A6	Reserved
A5	Reserved
A4	Reserved
A3	Reserved
A2	RF Switch
A1	Reserved
A0	Enable Off=0, On=1
D7	Reserved
D6	Attenuator 16 dB Control Bit
D5	Attenuator 8 dB Control Bit
D4	Attenuator 4 dB Control Bit
D3	Attenuator 2 dB Control Bit
D2	Attenuator 1 dB Control Bit
D1	Attenuator 0.5 dB Control Bit
D0	Reserved

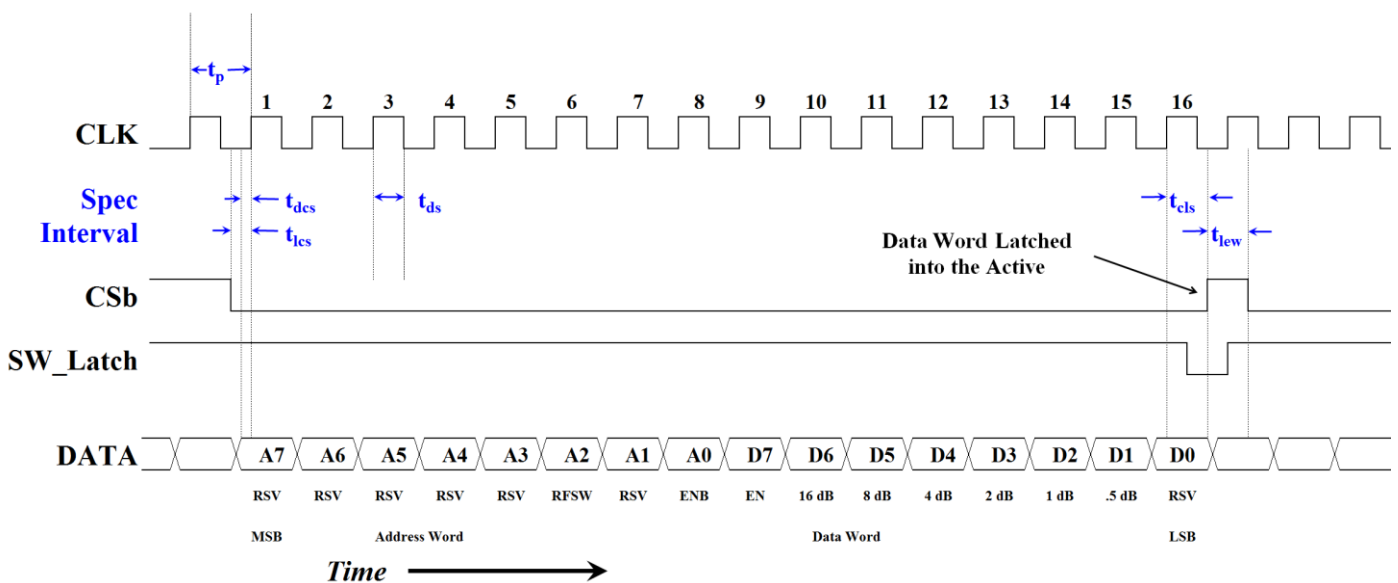

**Figure 1 - Serial Register Timing Diagram**

**Table 3 - Serial Mode Timing Table**

Interval Symbol	Description	Min Spec	Max Spec	Units
$t_p$	Clock Pulse Width	<b>10</b>		ns
$t_{ds}$	Clock high pulse width	<b>5</b>		ns
$t_{cls}$	Clock to CSb Hold Time. From the rising edge of CLK pulse for D0 to Csb rising edge minus half the clock period.	<b>10</b>		ns
$t_{lew}$	CSb pulse width	<b>3</b>		ns
$t_{dcs}$	Data Setup Time - From the starting edge of Data bit to rising edge of CLK	<b>3</b>		ns
$t_{dht}$	Data Hold Time - From rising edge of CLK to falling edge of the Data bit.	<b>10</b>		ns

**To program the serial interface:**

If CSb is de-asserted (set to high), the serial interface will ignore the CLK line. Once CSb is asserted (set to low), the serial interface will recognize the CLK and any data present on DATA will be clocked into the registers with each rising CLK edge. After the 16<sup>th</sup> CLK cycle, and before the 17<sup>th</sup> CLK cycle, CSb must be de-asserted to successfully program the part with the desired bytes. If CSb is de-asserted before the 16<sup>th</sup> CLK cycle, or after the 17<sup>th</sup> CLK cycle, there is no guarantee that the correct bytes will be programmed and the user will have to re-program the interface in accordance with the aforementioned procedure.

**SW\_LATCH programming sequence**

- When SW\_LATCH is pinned high during the programming sequence, "RFSW" and "ENb" registers cannot be programmed and therefore will not toggle.
- If SW\_LATCH is pinned low during the programming sequence, the "RFSW" and "ENb" register will toggle. This can be prevented with the "Programming Sequence" below.

**Sequence for programming registers A2, A0**

1. SW\_Latch = 1; CSb = 0
2. CLK in 8- or 16-bit word, do not de-assert (pull high) CSb
3. Set SW\_LATCH = 0 while CSb = 0 remains)
4. With SW\_Latch = 0, set CSb = 1
5. Set SW\_Latch = 1
6. Program complete

**F1358 Attenuation Table**

The F1358 attenuation setting is controlled by 6 bits in the data word. The device provides for an attenuation range from 0 dB to 25.5 dB in 0.5 dB steps. A "high" or "1" bit corresponds to attenuation stepped IN, while a "low" or "0" bit corresponds to attenuation stepped OUT.

Because the first and last bits of the Data Word are not presently used by the F1358, two additional hex character pairs exist for each of those in this table. For example, data words of either H00, H80, or H01 (binary "00000000," "10000000," or "00000001") will place the F1358 in its minimum attenuation state.



Likewise, data words of either H66, HE6, or H67 (binary "01100110" or "11100110" or "01100111") will place the F1358 in its maximum attenuation state of 25.5 added attenuation.

**Table 4 - Attenuation Digital Word Table**

State	Attenuation (dB)	Hex	Binary D7 – D0	State	Attenuation (dB)	Hex	Binary D7 – D0
0	0.0	00	00000000	26	13.0	34	00110100
1	0.5	02	00000010	27	13.5	36	00110110
2	1.0	04	00000100	28	14.0	38	00111000
3	1.5	06	00000110	29	14.5	3A	00111010
4	2.0	08	00001000	30	15.0	3C	00111100
5	2.5	0A	00001010	31	15.5	3E	00111110
6	3.0	0C	00001100	32	16.0	40	01000000
7	3.5	0E	00001110	33	16.5	42	01000010
8	4.0	10	00010000	34	17.0	44	01000100
9	4.5	12	00010010	35	17.5	46	01000110
10	5.0	14	00010100	36	18.0	48	01001000
11	5.5	16	00010110	37	18.5	4A	01001010
12	6.0	18	00011000	38	19.0	4C	01001100
13	6.5	1A	00011010	39	19.5	4E	01001110
14	7.0	1C	00011100	40	20.0	50	01010000
15	7.5	1E	00011110	41	20.5	52	01010010
16	8.0	20	00100000	42	21.0	54	01010100
17	8.5	22	00100010	43	21.5	56	01010110
18	9.0	24	00100100	44	22.0	58	01011000
19	9.5	26	00100110	45	22.5	5A	01011010
20	10.0	28	00101000	46	23.0	5C	01011100
21	10.5	2A	00101010	47	23.5	5E	01011110
22	11.0	2C	00101100	48	24.0	60	01100000
23	11.5	2E	00101110	49	24.5	62	01100010
24	12.0	30	00110000	50	25.0	64	01100100
25	12.5	32	00110010	51	25.5	66	01100110

## TYPICAL OPERATING CONDITIONS (TOC)

Unless otherwise noted for the TOC graphs on the following pages, the following conditions apply.

- **IF = 200 MHz**
- **Tone spacing = 5 MHz**
- **Pin = -11 dBm / Tone**
- **Pout ~ 0 dBm / Tone**
- **RF\_INX, IF\_Q selected**
- **Minimum Attenuation selected (0 dB ATTN)**
- **VCC = 5.00 V**
- **LO level = 0 dBm**
- **Case Temperature = +25 °C**
- **All Temperatures are Case Temperature ( $T_{CASE}$ )**
- **Output Transformers are de-embedded**
- **Input RF trace losses are de-embedded**

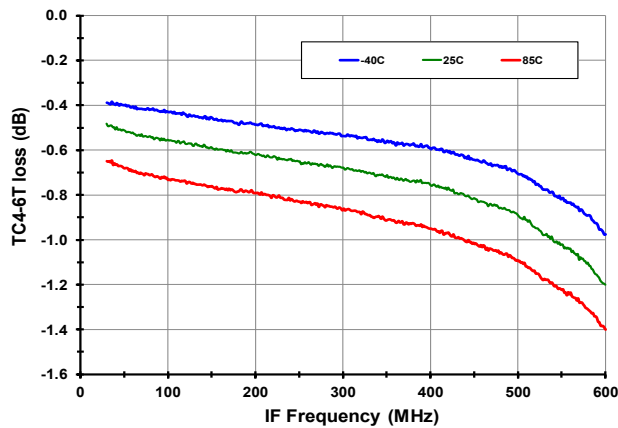

## TYPICAL OPERATING CONDITIONS (- 1 -)

Gain vs.  $T_{case}$  [Low Side LO,  $RF_X$ ]

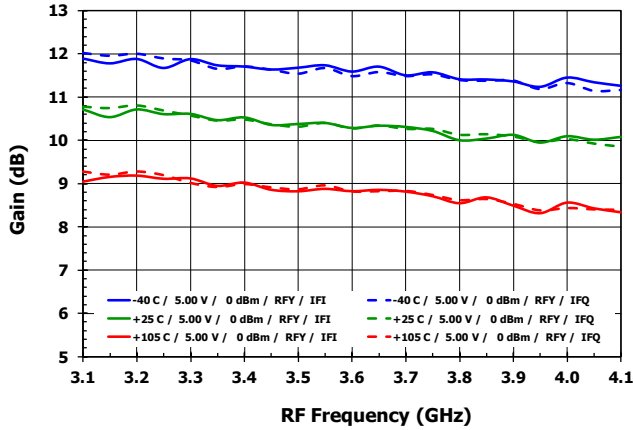

Gain vs.  $T_{case}$  [Low Side LO,  $RF_Y$ ]

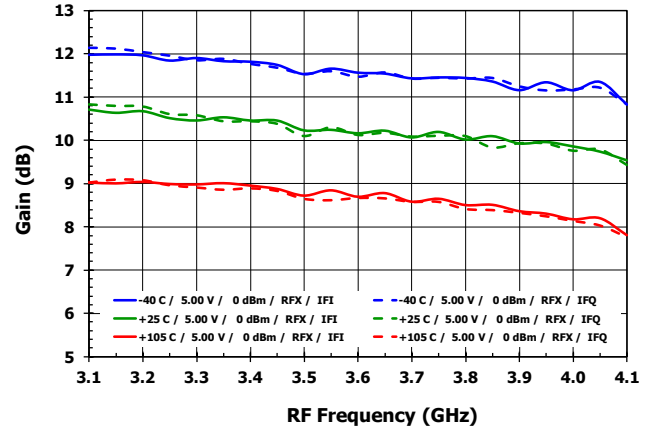

Gain vs.  $V_{cc}$ [Low Side LO,  $RF_X$ ]

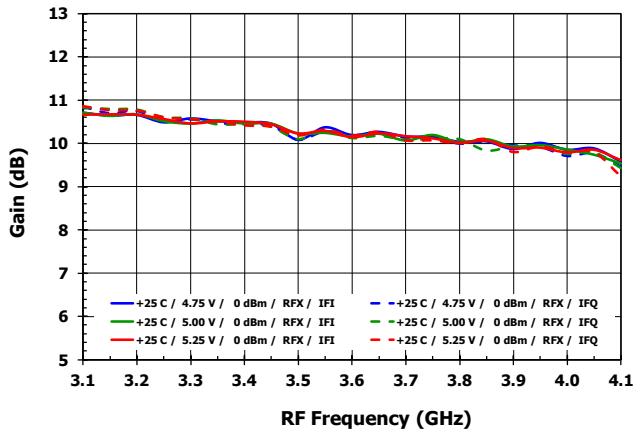

Gain vs.  $V_{cc}$ [Low Side LO,  $RF_Y$ ]

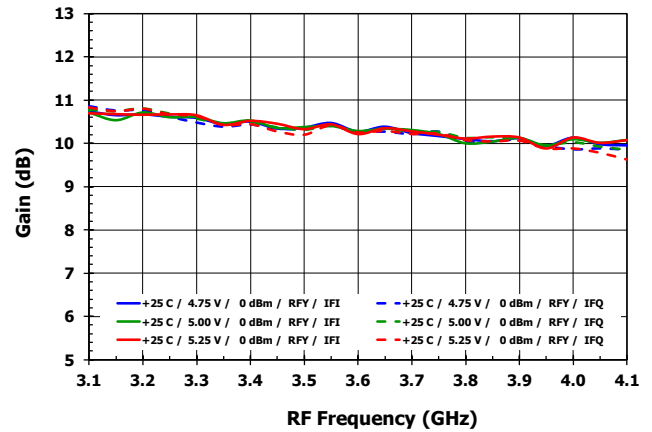

Gain vs. LO Power [Low Side LO,  $RF_X$ ]

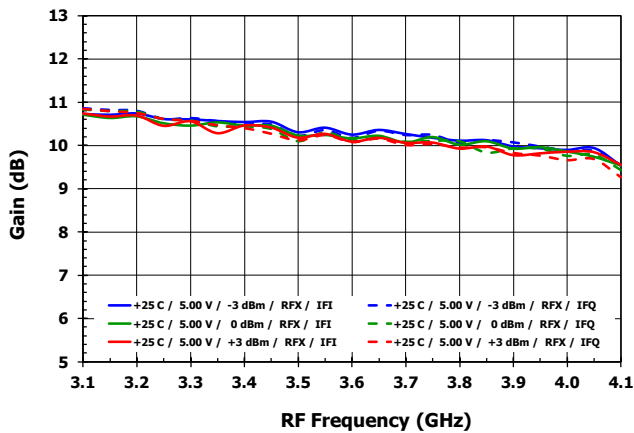

Gain vs. LO Power [Low Side LO,  $RF_Y$ ]

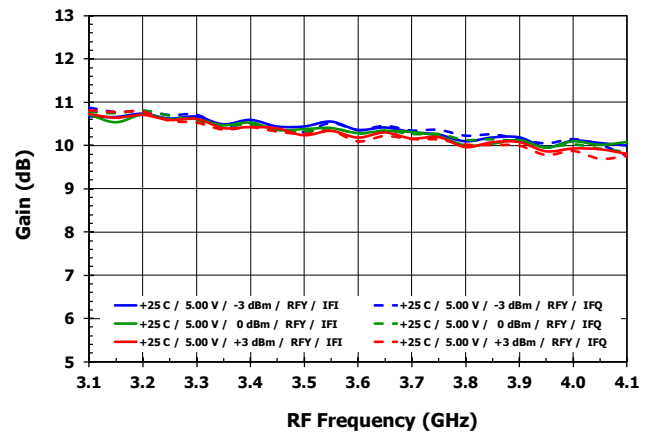

## TYPICAL OPERATING CONDITIONS (- 2 -)

Gain vs.  $T_{case}$  [High Side LO,  $RF_X$ ]

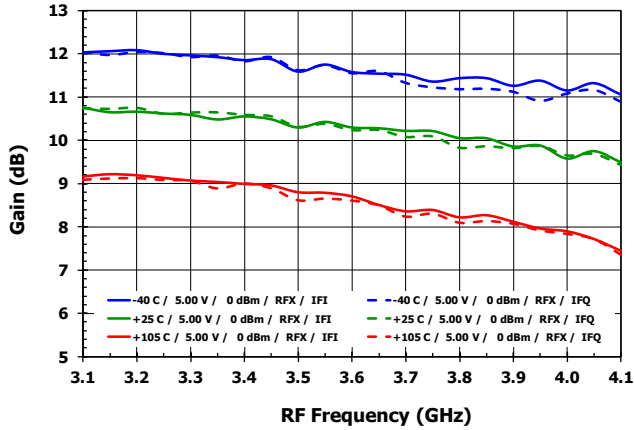

Gain vs.  $T_{case}$  [High Side LO,  $RF_Y$ ]

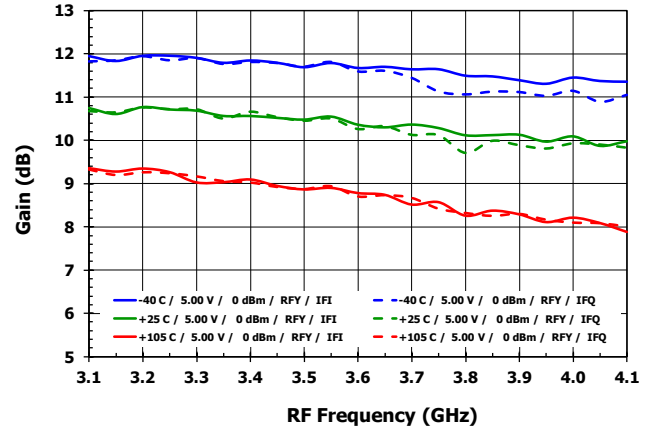

Gain vs.  $V_{cc}$ [High Side LO,  $RF_X$ ]

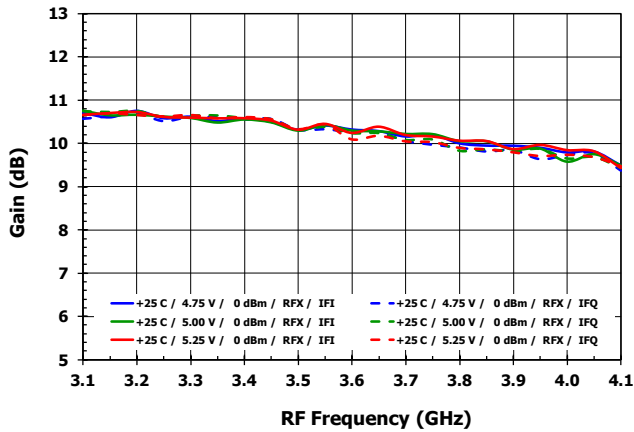

Gain vs.  $V_{cc}$ [High Side LO,  $RF_Y$ ]

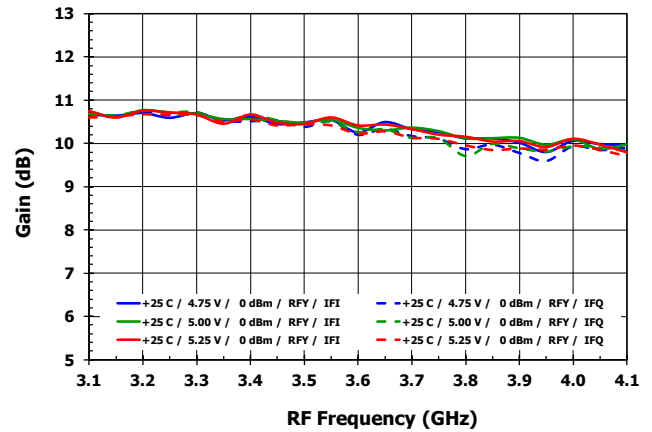

Gain vs. LO Power [High Side LO,  $RF_X$ ]

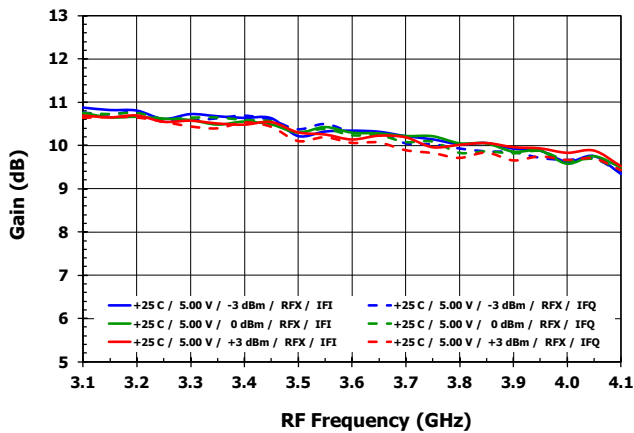

Gain vs. LO Power [High Side LO,  $RF_Y$ ]

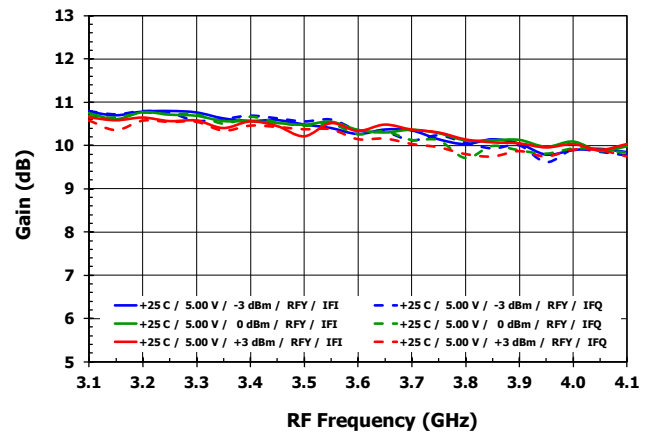

## TYPICAL OPERATING CONDITIONS (- 3 -)

OIP3 vs.  $T_{case}$  [Low Side LO,  $RF_X$ ]

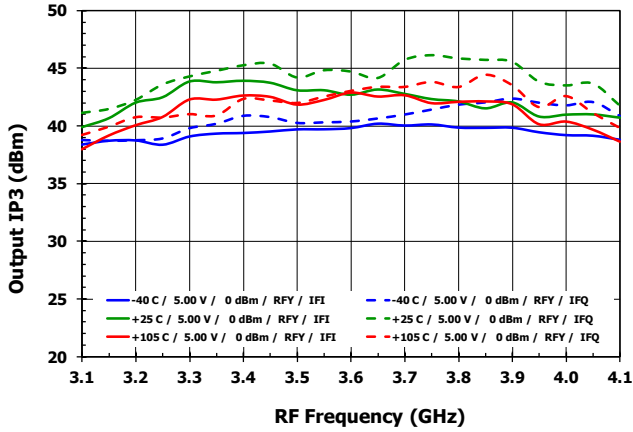

OIP3 vs.  $T_{case}$  [Low Side LO,  $RF_Y$ ]

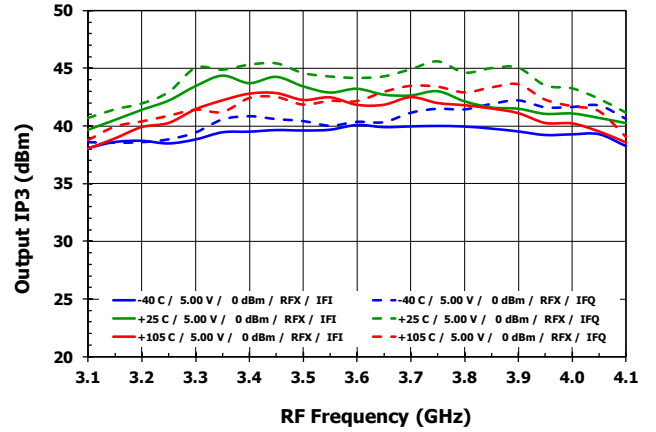

OIP3 vs.  $V_{cc}$  [Low Side LO,  $RF_X$ ]

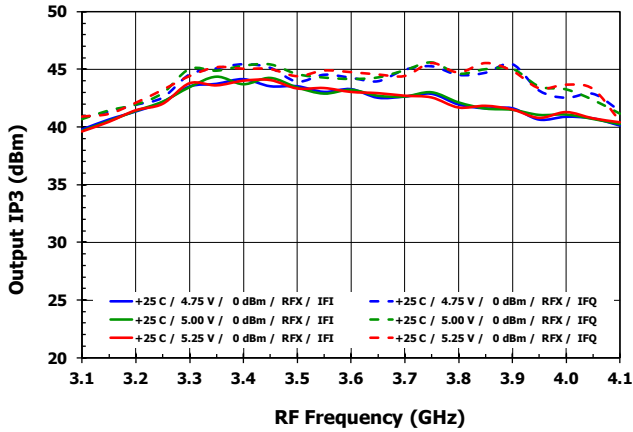

OIP3 vs.  $V_{cc}$  [Low Side LO,  $RF_Y$ ]

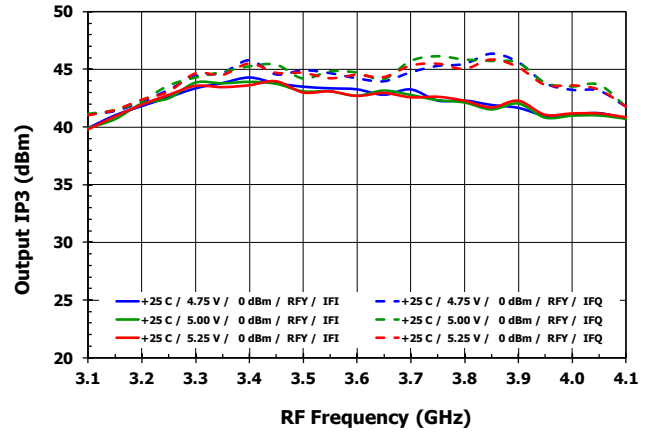

OIP3 vs. LO Power [Low Side LO,  $RF_X$ ]

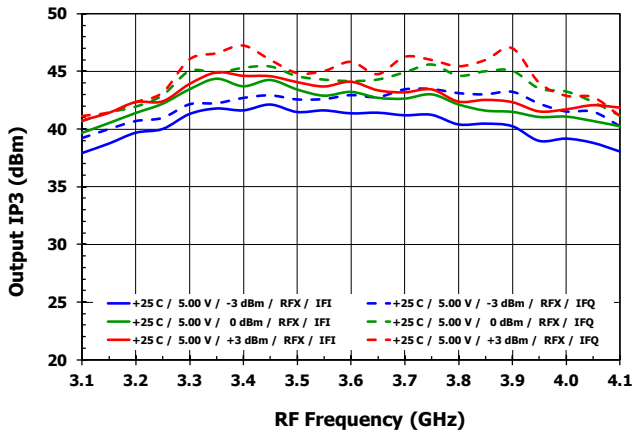

OIP3 vs. LO Power [Low Side LO,  $RF_Y$ ]

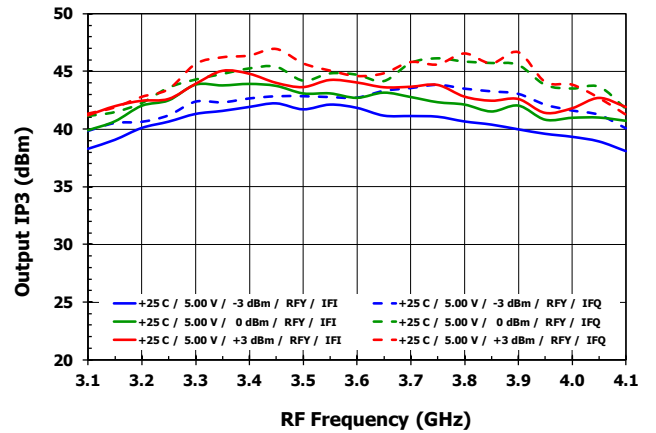

## TYPICAL OPERATING CONDITIONS (- 4 -)

OIP3 vs.  $T_{case}$  [High Side LO,  $RF_X$ ]

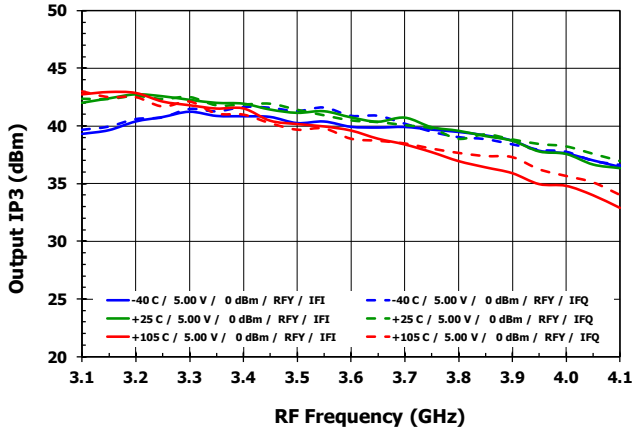

OIP3 vs.  $T_{case}$  [High Side LO,  $RF_Y$ ]

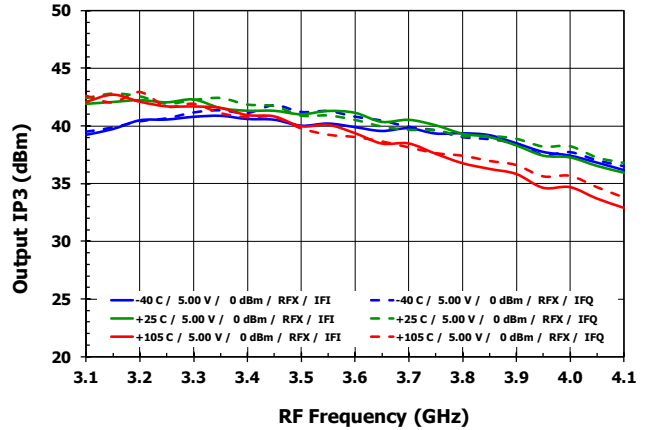

OIP3 vs.  $V_{cc}$  [High Side LO,  $RF_X$ ]

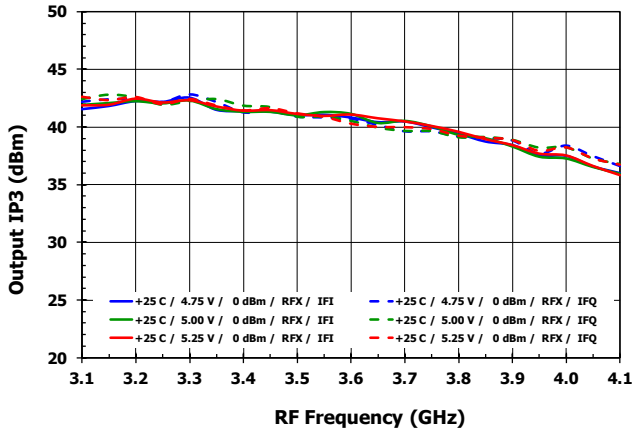

OIP3 vs.  $V_{cc}$  [High Side LO,  $RF_Y$ ]

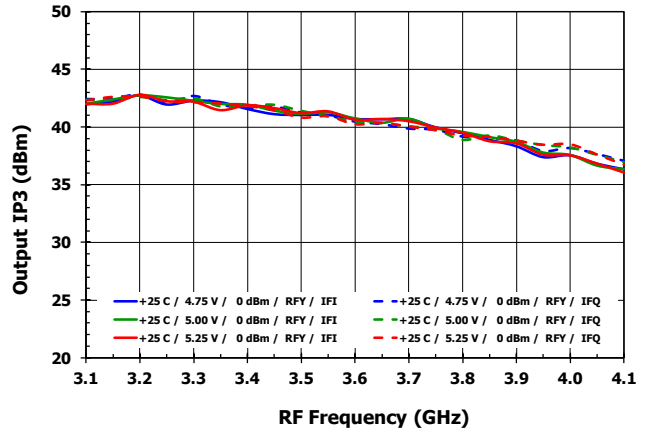

OIP3 vs. LO Power [High Side LO,  $RF_X$ ]

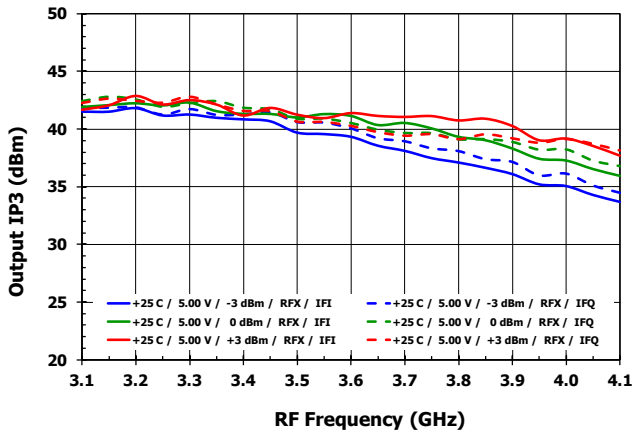

OIP3 vs. LO Power [High Side LO,  $RF_Y$ ]

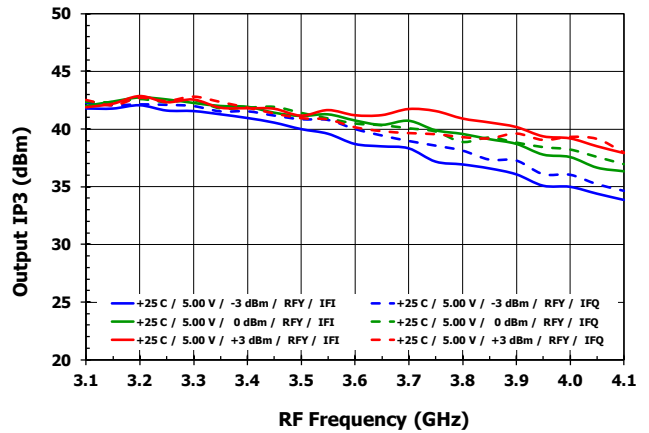

## TYPICAL OPERATING CONDITIONS (- 5 -)

### OIP2 vs. T<sub>case</sub> [Low Side LO, RF<sub>X</sub>]

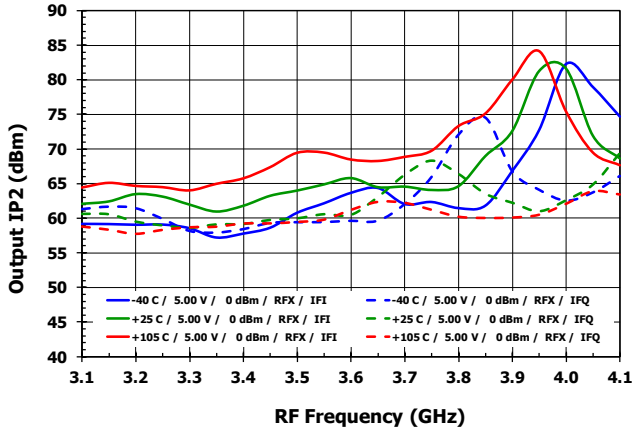

### OIP2 vs. T<sub>case</sub> [Low Side LO, RF<sub>Y</sub>]

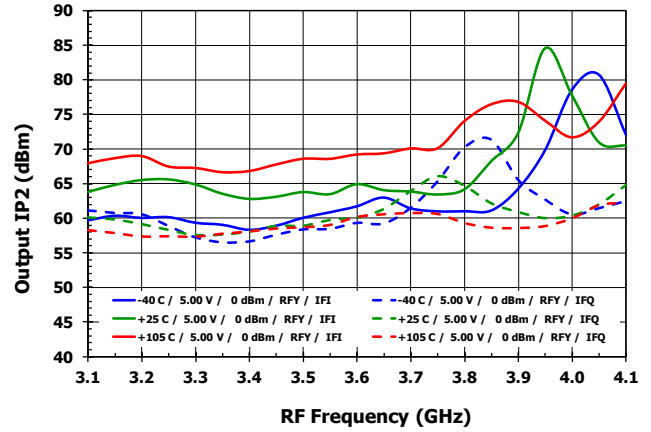

### OIP2 vs. V<sub>cc</sub>[Low Side LO, RF<sub>X</sub>]

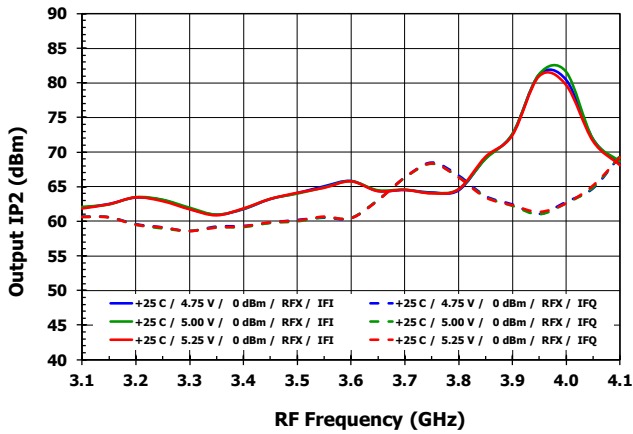

### OIP2 vs. V<sub>cc</sub>[Low Side LO, RF<sub>Y</sub>]

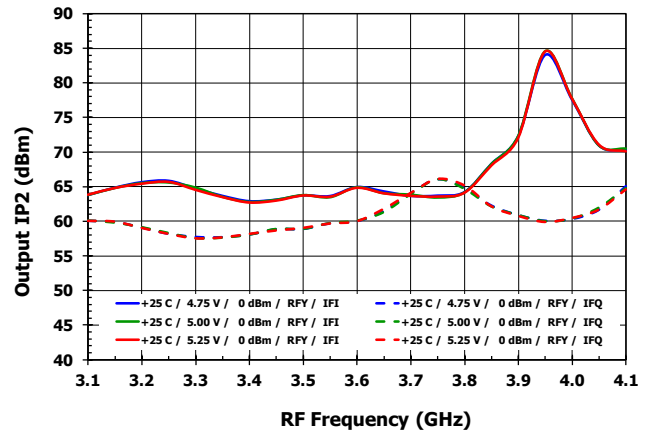

### OIP2 vs. LO Power [Low Side LO, RF<sub>X</sub>]

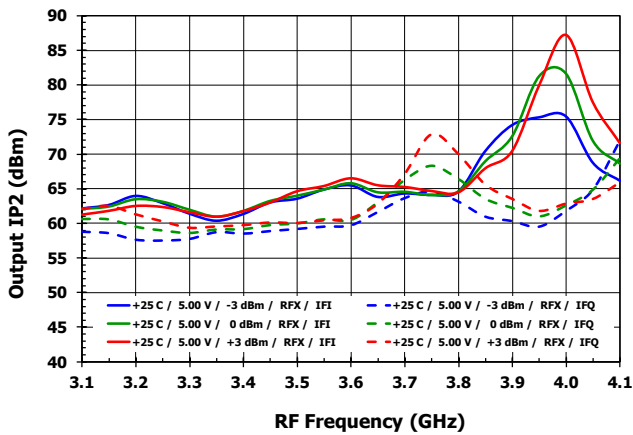

### OIP2 vs. LO Power [Low Side LO, RF<sub>Y</sub>]

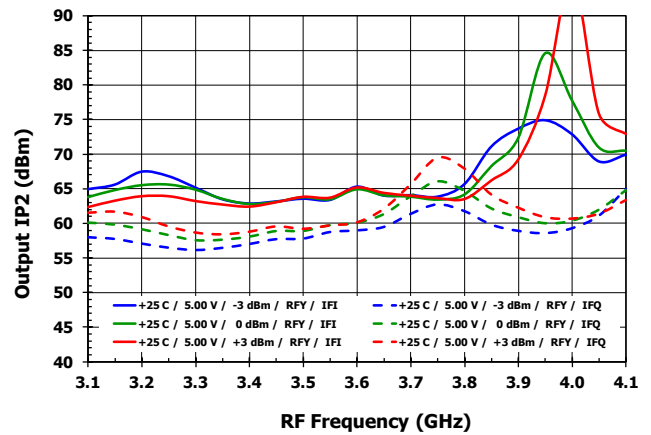

## TYPICAL OPERATING CONDITIONS (- 6 -)

OIP2 vs.  $T_{case}$  [High Side LO,  $RF_X$ ]

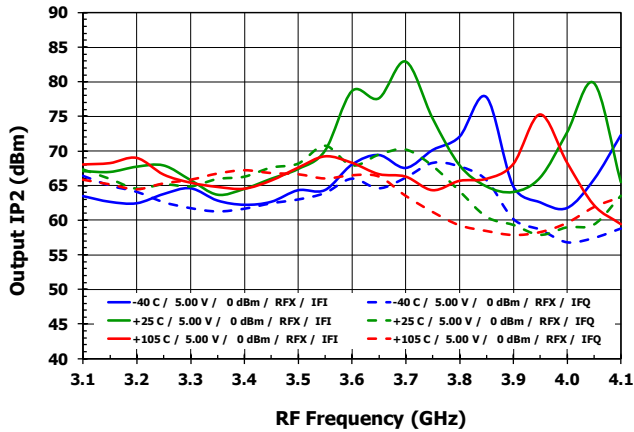

OIP2 vs.  $T_{case}$  [High Side LO,  $RF_Y$ ]

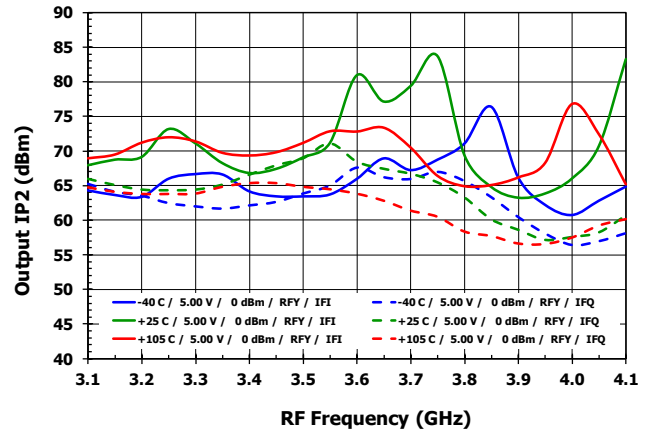

OIP2 vs.  $V_{cc}$  [High Side LO,  $RF_X$ ]

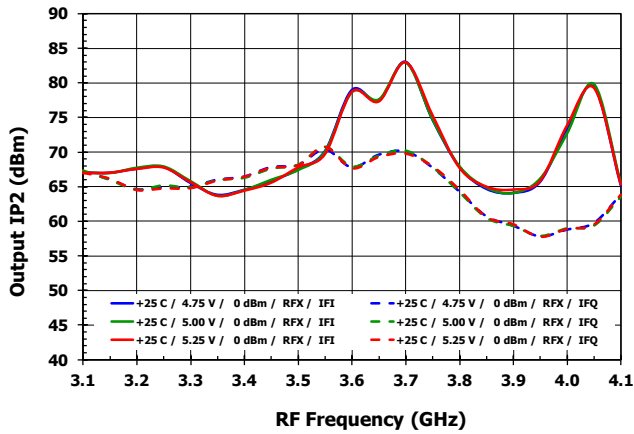

OIP2 vs.  $V_{cc}$  [High Side LO,  $RF_Y$ ]

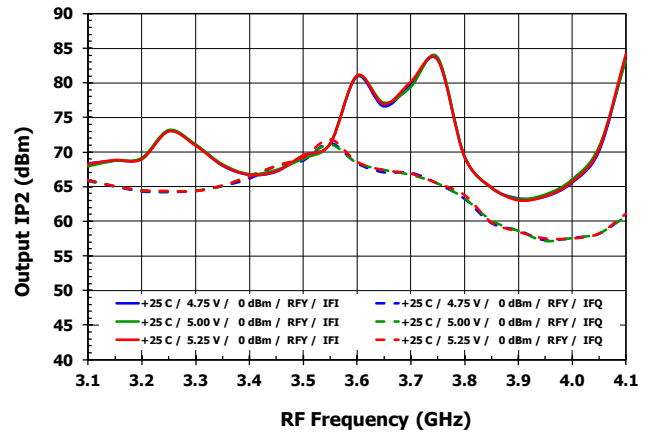

OIP2 vs. LO Power [High Side LO,  $RF_X$ ]

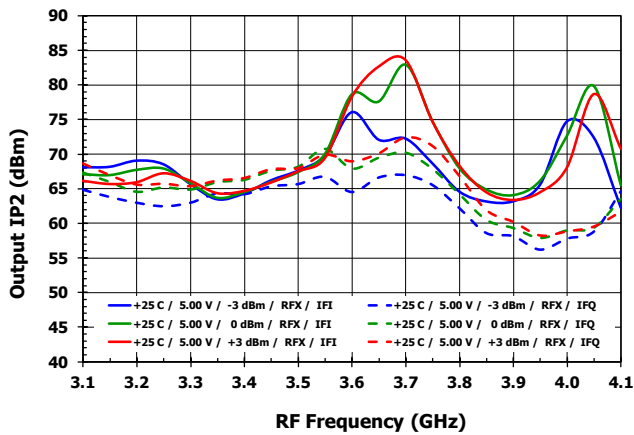

OIP2 vs. LO Power [High Side LO,  $RF_Y$ ]

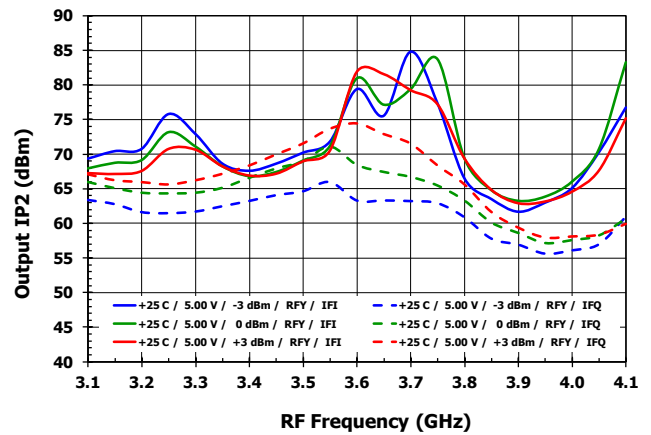



## TYPICAL OPERATING CONDITIONS (- 7 -)

2<sup>nd</sup> Harmonic vs. T<sub>case</sub> [Low Side LO, RF<sub>X</sub>, P<sub>IF</sub>=-6 dBm]

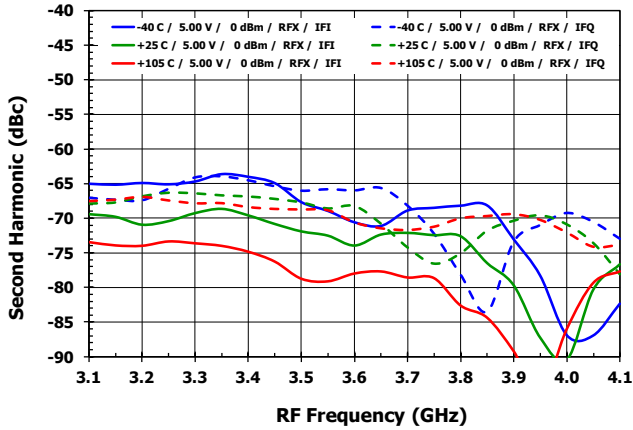

2<sup>nd</sup> Harmonic vs. T<sub>case</sub> [Low Side LO, RF<sub>Y</sub>, P<sub>IF</sub>=-6 dBm]

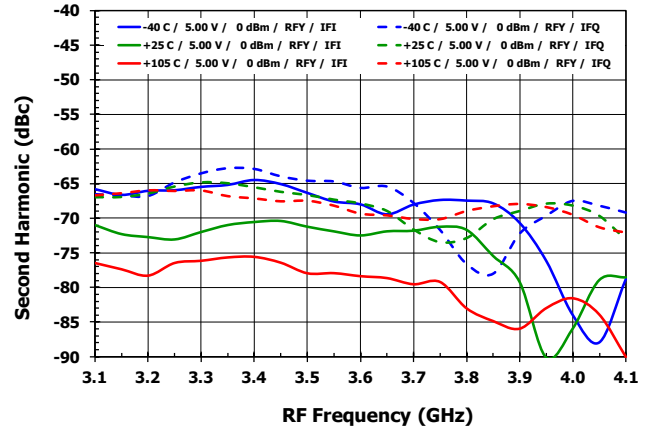

2<sup>nd</sup> Harmonic vs. V<sub>cc</sub>[Low Side LO, RF<sub>X</sub>, P<sub>IF</sub>=-6 dBm]

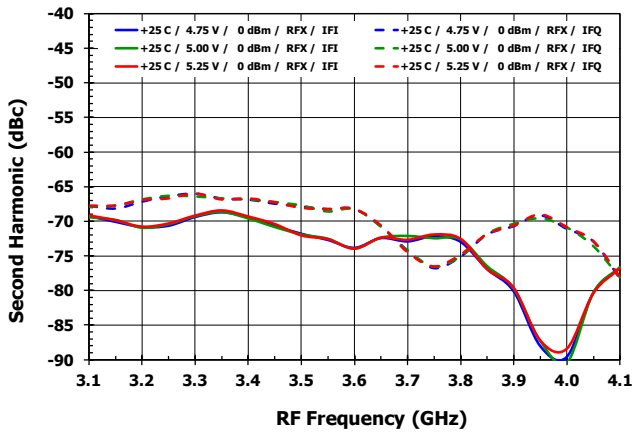

2<sup>nd</sup> Harmonic vs. V<sub>cc</sub>[Low Side LO, RF<sub>Y</sub>, P<sub>IF</sub>=-6 dBm]

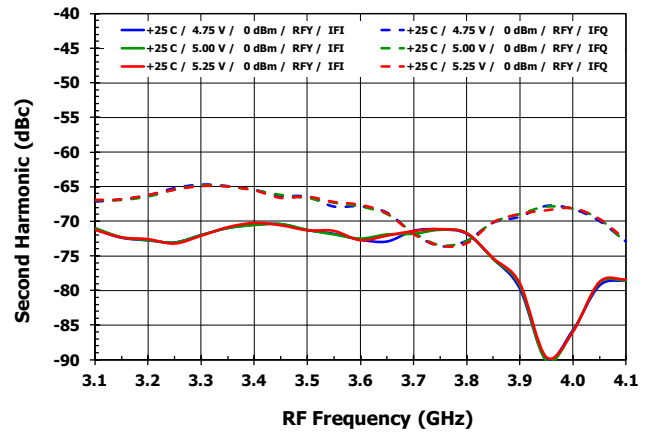

2<sup>nd</sup> Harmonic vs. LO Power [Low Side LO, RF<sub>X</sub>, P<sub>IF</sub>=-6 dBm]

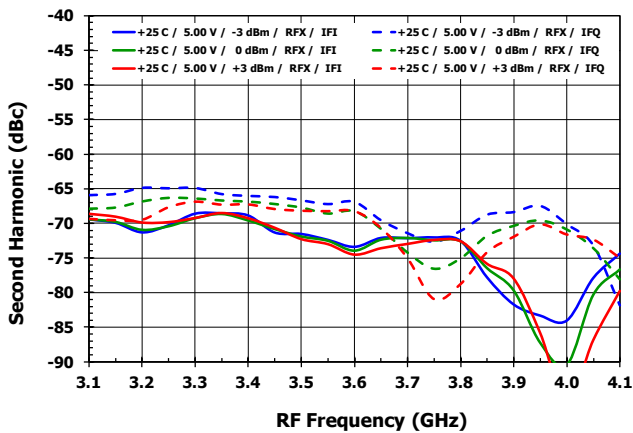

2<sup>nd</sup> Harmonic vs. LO Power [Low Side LO, RF<sub>Y</sub>, P<sub>IF</sub>=-6 dBm]

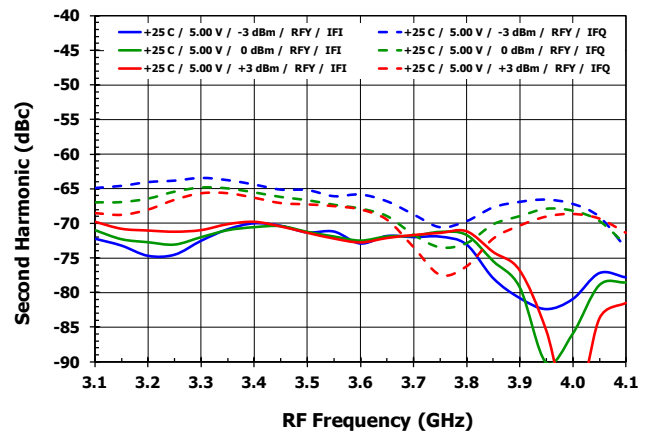

## TYPICAL OPERATING CONDITIONS (- 8 -)

2<sup>nd</sup> Harmonic vs. T<sub>case</sub> [High Side LO, RF<sub>X</sub>, P<sub>IF</sub>=-6 dBm]

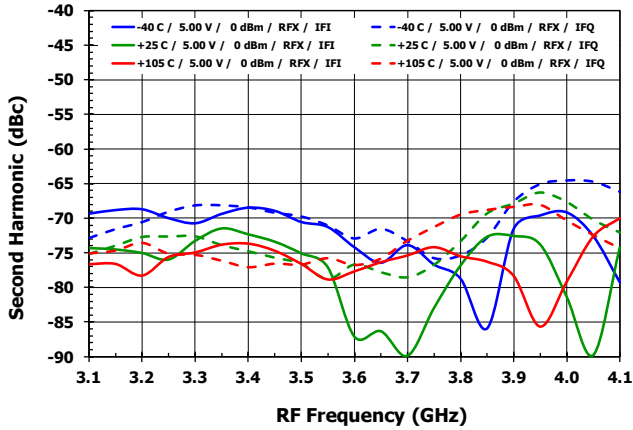

2<sup>nd</sup> Harmonic vs. T<sub>case</sub> [High Side LO, RF<sub>Y</sub>, P<sub>IF</sub>=-6 dBm]

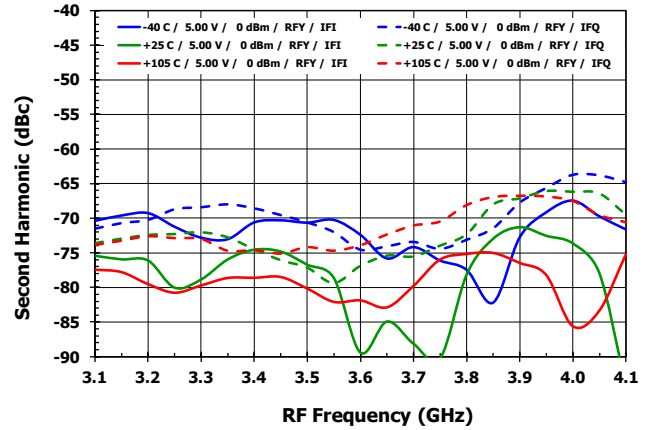

2<sup>nd</sup> Harmonic vs. V<sub>cc</sub> [High Side LO, RF<sub>X</sub>, P<sub>IF</sub>=-6 dBm]

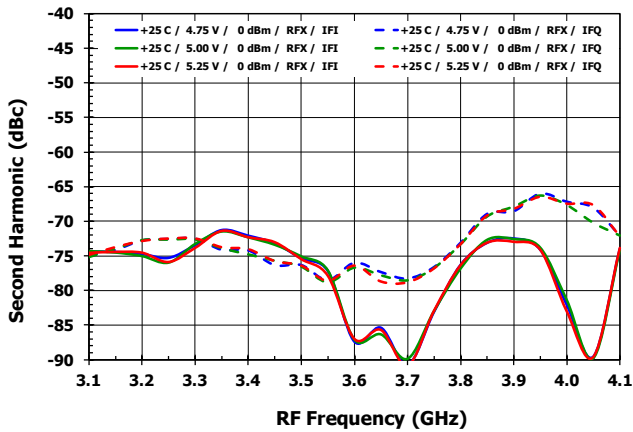

2<sup>nd</sup> Harmonic vs. V<sub>cc</sub> [High Side LO, RF<sub>Y</sub>, P<sub>IF</sub>=-6 dBm]

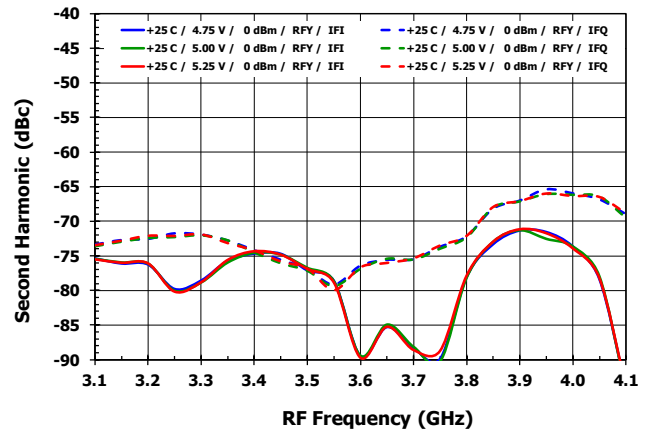

2<sup>nd</sup> Harmonic vs. LO Power [High Side LO, RF<sub>X</sub>, P<sub>IF</sub>=-6 dBm]

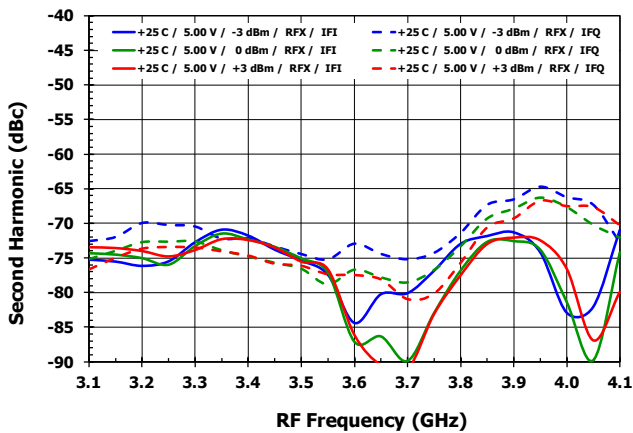

2<sup>nd</sup> Harmonic vs. LO Power [High Side LO, RF<sub>Y</sub>, P<sub>IF</sub>=-6 dBm]

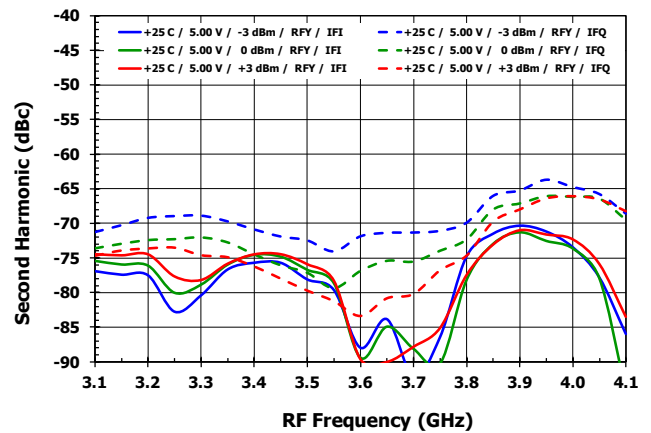

## TYPICAL OPERATING CONDITIONS (- 9 -)

### 3<sup>rd</sup> Harmonic vs. T<sub>case</sub> [Low Side LO, RF<sub>X</sub>]

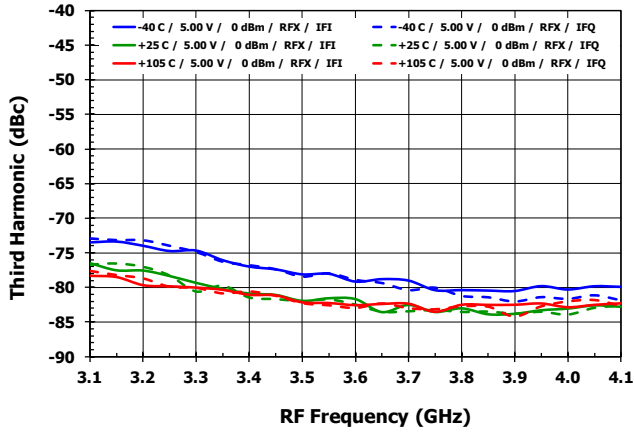

### 3<sup>rd</sup> Harmonic vs. T<sub>case</sub> [Low Side LO, RF<sub>Y</sub>]

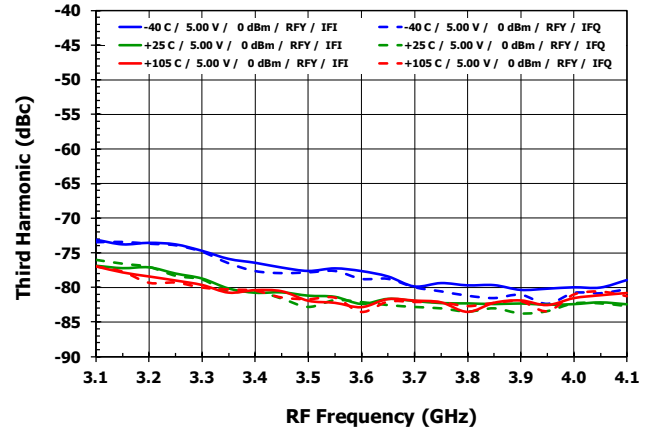

### 3<sup>rd</sup> Harmonic vs. V<sub>cc</sub>[Low Side LO, RF<sub>X</sub>]

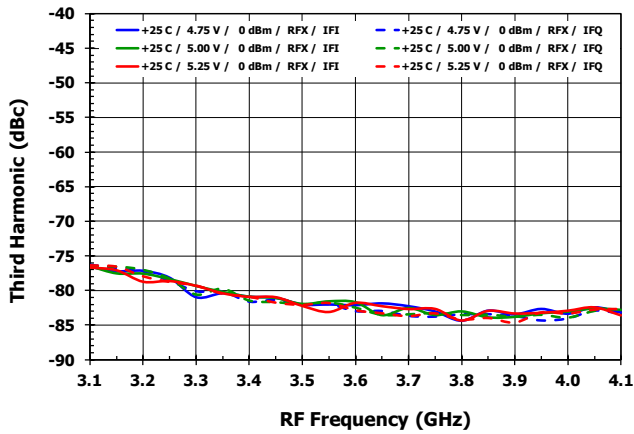

### 3<sup>rd</sup> Harmonic vs. V<sub>cc</sub>[Low Side LO, RF<sub>Y</sub>]

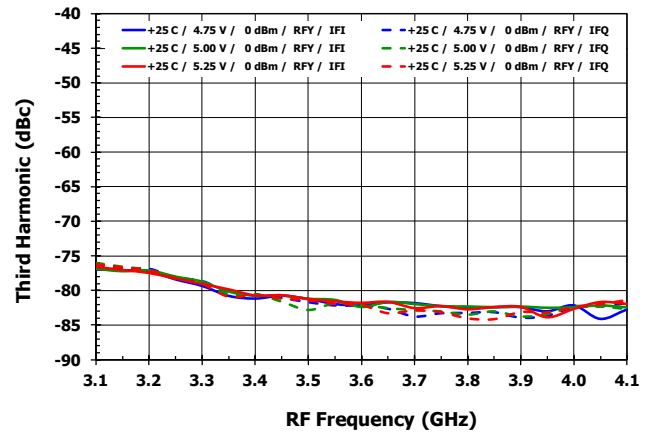

### 3<sup>rd</sup> Harmonic vs. LO Power [Low Side LO, RF<sub>X</sub>]

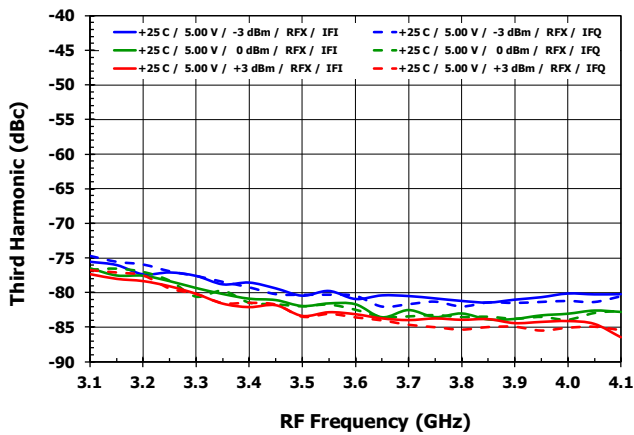

### 3<sup>rd</sup> Harmonic vs. LO Power [Low Side LO, RF<sub>Y</sub>]

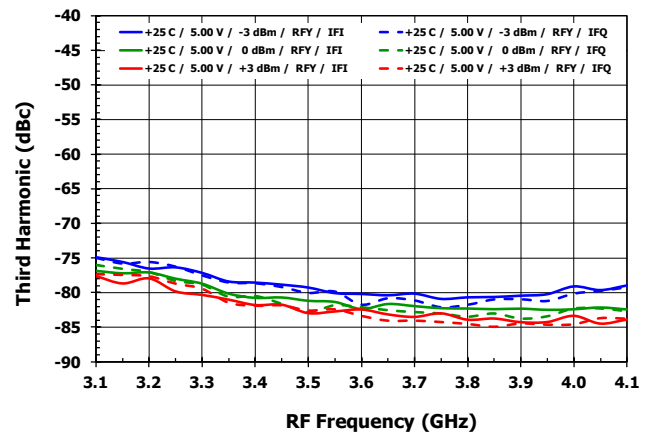

## TYPICAL OPERATING CONDITIONS (- 10 -)

3<sup>rd</sup> Harmonic vs. T<sub>case</sub> [High Side LO, RF<sub>X</sub>]

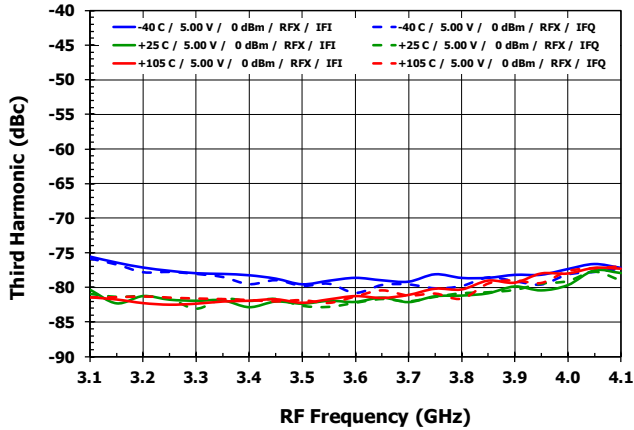

3<sup>rd</sup> Harmonic vs. T<sub>case</sub> [High Side LO, RF<sub>Y</sub>]

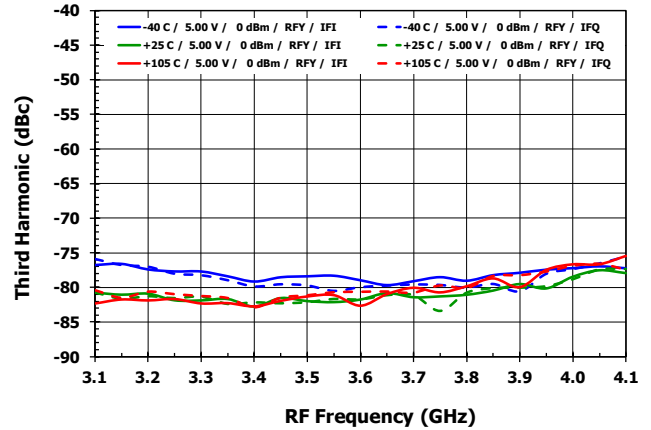

3<sup>rd</sup> Harmonic vs. V<sub>cc</sub>[High Side LO, RF<sub>X</sub>]

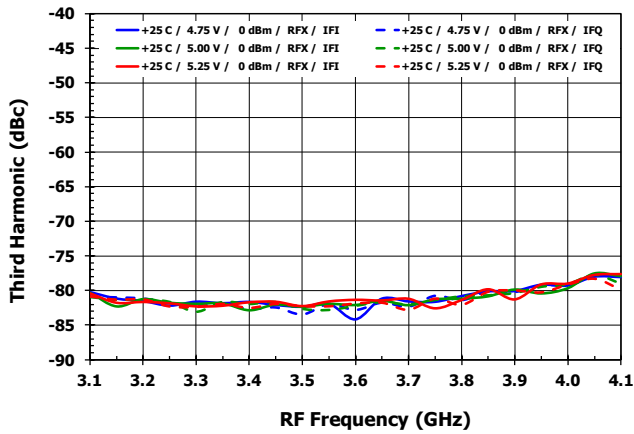

3<sup>rd</sup> Harmonic vs. V<sub>cc</sub>[High Side LO, RF<sub>Y</sub>]

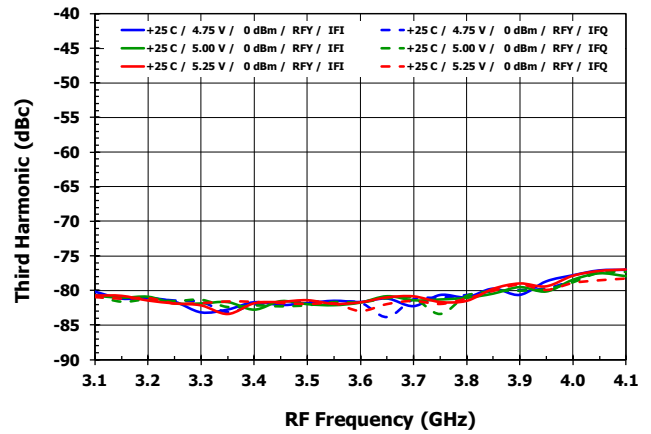

3<sup>rd</sup> Harmonic vs. LO Power [High Side LO, RF<sub>X</sub>]

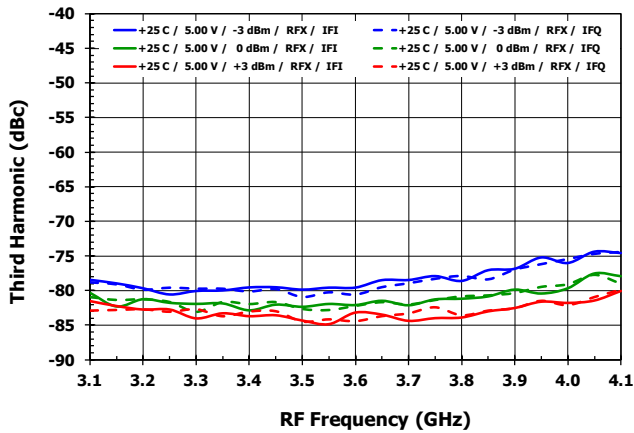

3<sup>rd</sup> Harmonic vs. LO Power [High Side LO, RF<sub>Y</sub>]

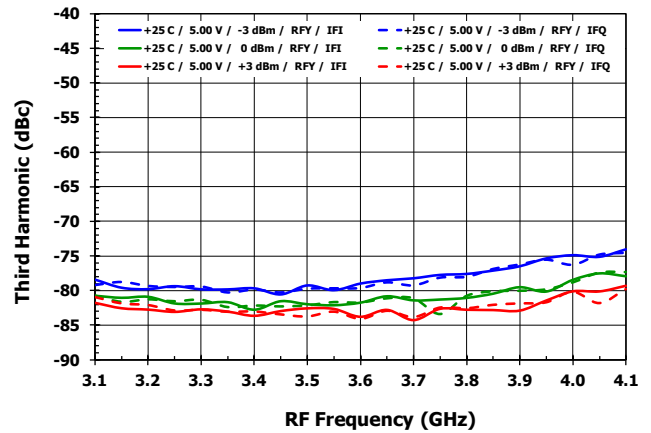

## TYPICAL OPERATING CONDITIONS (- 11 -)

Current vs.  $T_{case}$  [Low Side LO,  $RF_X$ ]

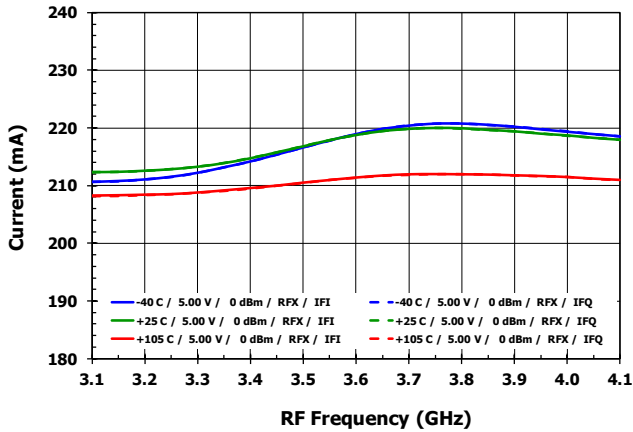

Current vs.  $T_{case}$  [Low Side LO,  $RF_Y$ ]

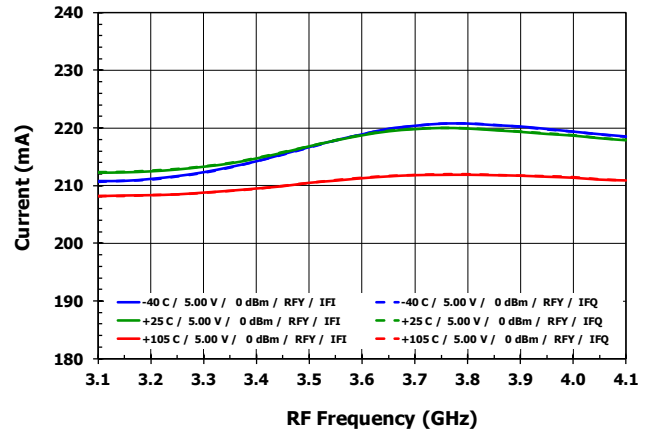

Current vs.  $V_{cc}$ [Low Side LO,  $RF_X$ ]

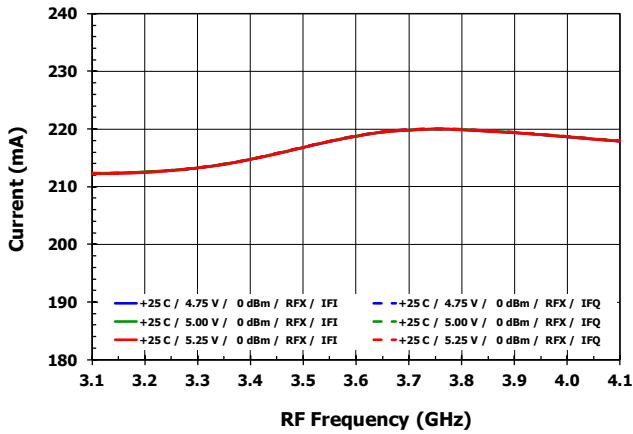

Current vs.  $V_{cc}$ [Low Side LO,  $RF_Y$ ]

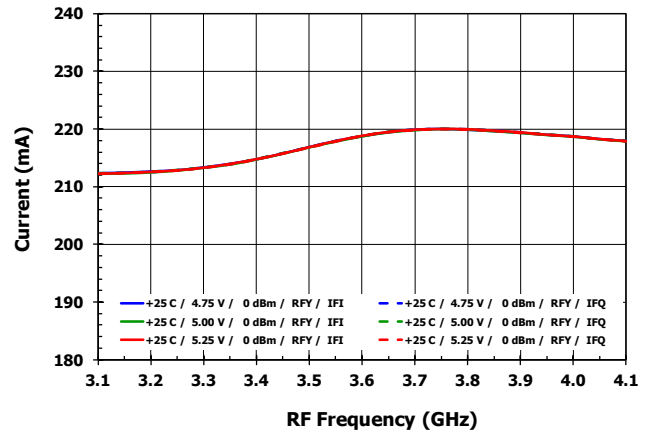

Current vs. LO Power [Low Side LO,  $RF_X$ ]

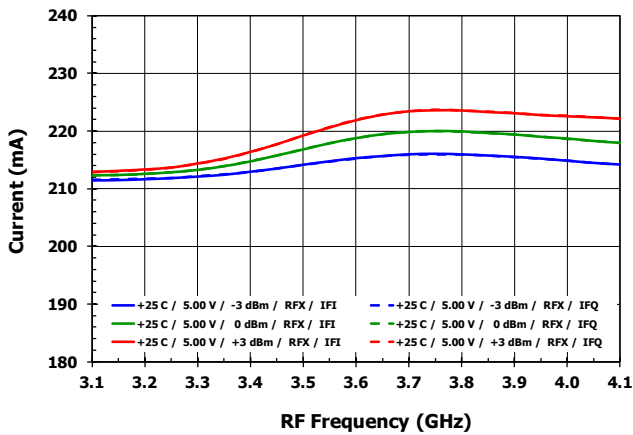

Current vs. LO Power [Low Side LO,  $RF_Y$ ]

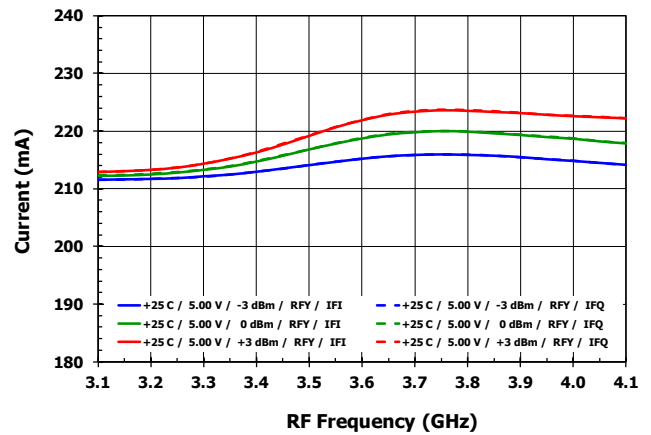

## TYPICAL OPERATING CONDITIONS (- 12 -)

Current vs.  $T_{case}$  [High Side LO,  $RF_X$ ]

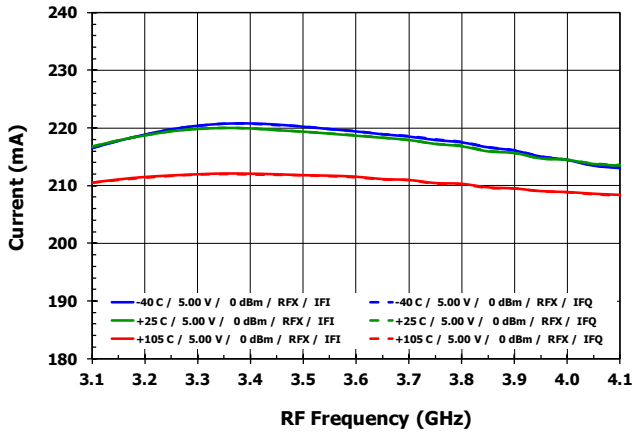

Current vs.  $T_{case}$  [High Side LO,  $RF_Y$ ]

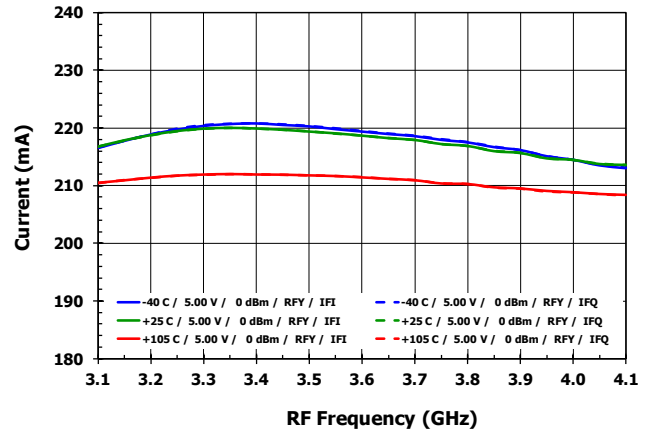

Current vs.  $V_{cc}$ [High Side LO,  $RF_X$ ]

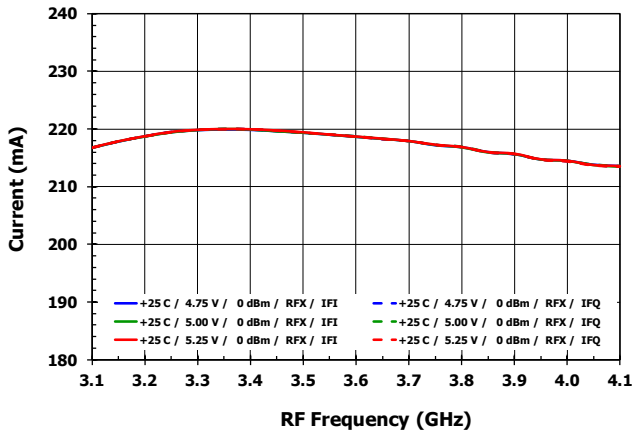

Current vs.  $V_{cc}$ [High Side LO,  $RF_Y$ ]

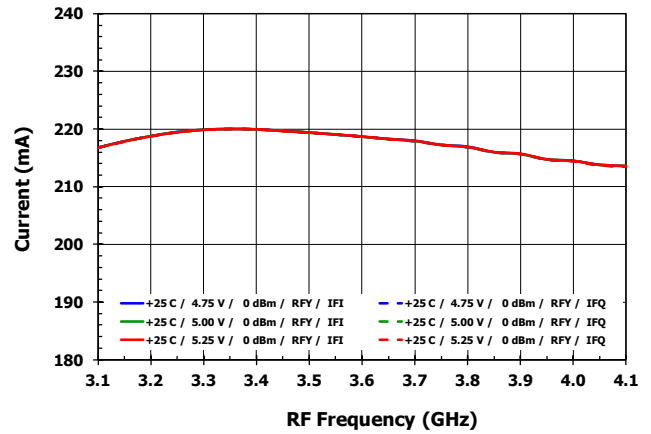

Current vs. LO Power [High Side LO,  $RF_X$ ]

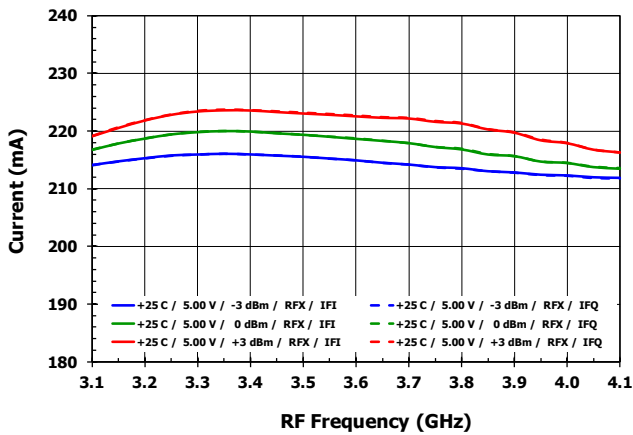

Current vs. LO Power [High Side LO,  $RF_Y$ ]

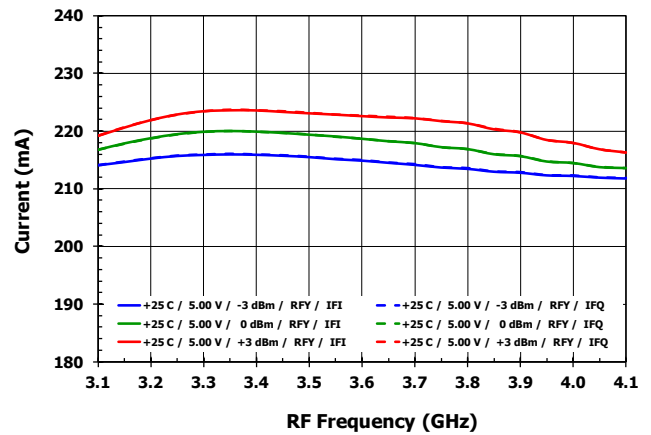

## TYPICAL OPERATING CONDITIONS (- 13 -)

Gain vs. Attenuator Setting [Low Side LO, RF<sub>x</sub>]

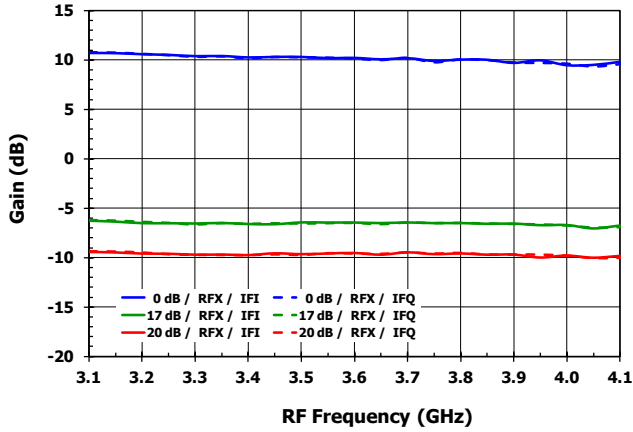

Gain vs. Attenuator Setting [Low Side LO, RF<sub>y</sub>]

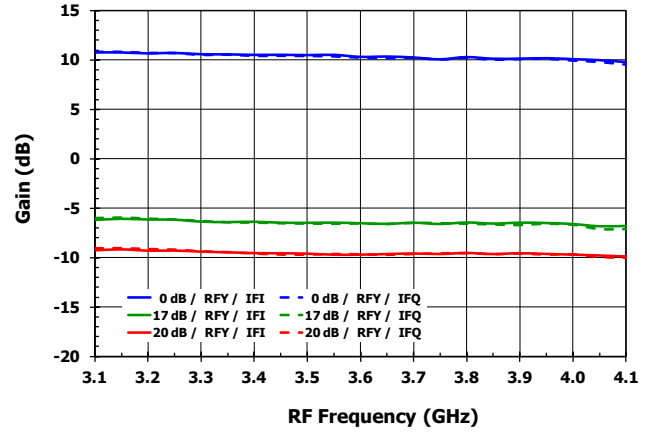

Gain vs. Attenuator Setting [High Side LO, RF<sub>x</sub>]

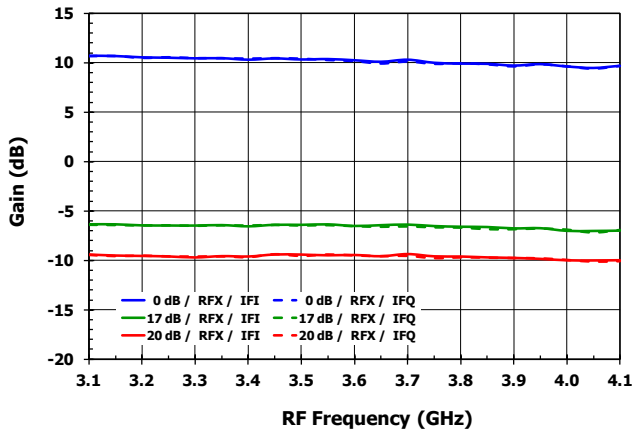

Gain vs. Attenuator Setting [High Side LO, RF<sub>y</sub>]

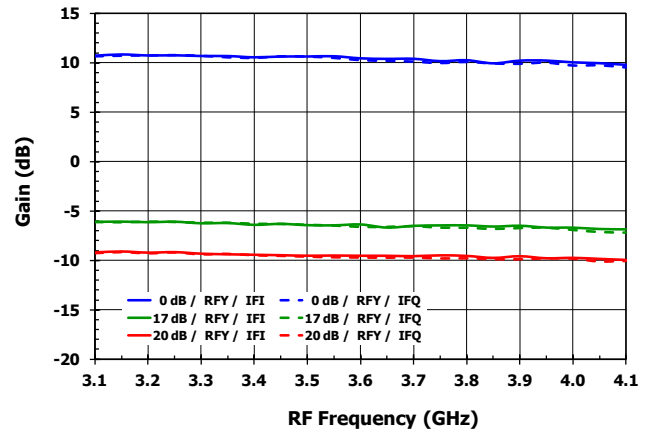

OIP3 vs. Attenuation Setting [Low Side LO, RF<sub>x</sub>]

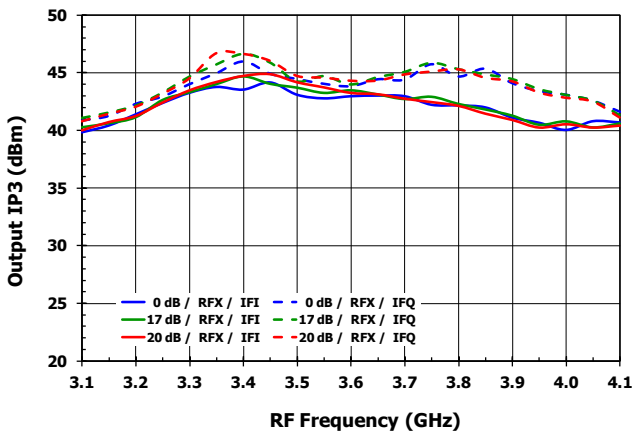

OIP3 vs. Attenuation Setting [Low Side LO, RF<sub>y</sub>]

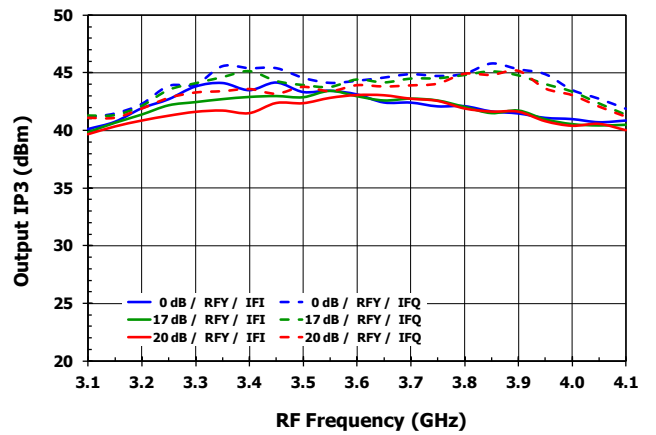

## TYPICAL OPERATING CONDITIONS (- 14 -)

OIP3 vs. Attenuation Setting [High Side LO, RF<sub>X</sub>]

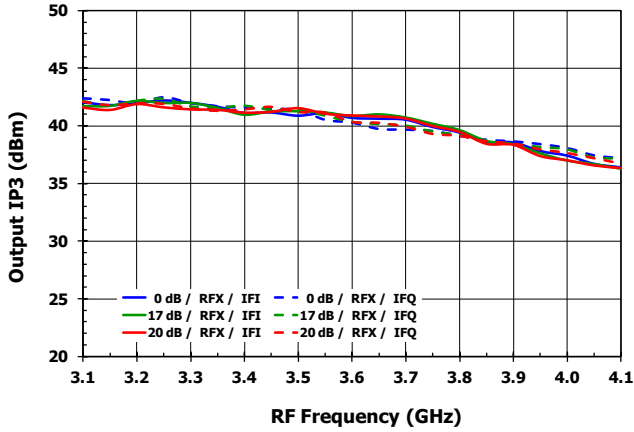

OIP3 vs. Attenuation Setting [High Side LO, RF<sub>Y</sub>]

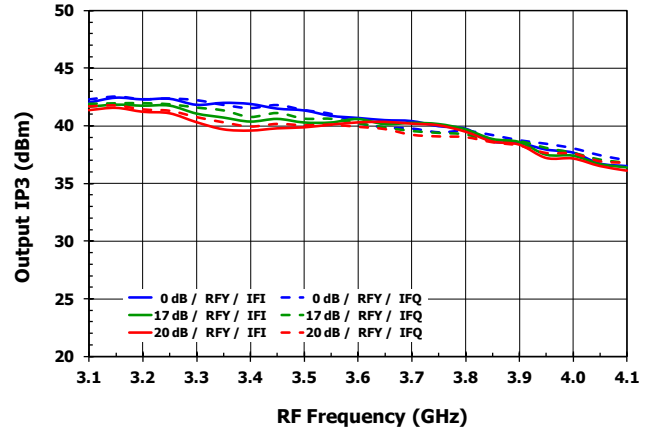

OIP2 vs. Attenuation Setting [Low Side LO, RF<sub>X</sub>]

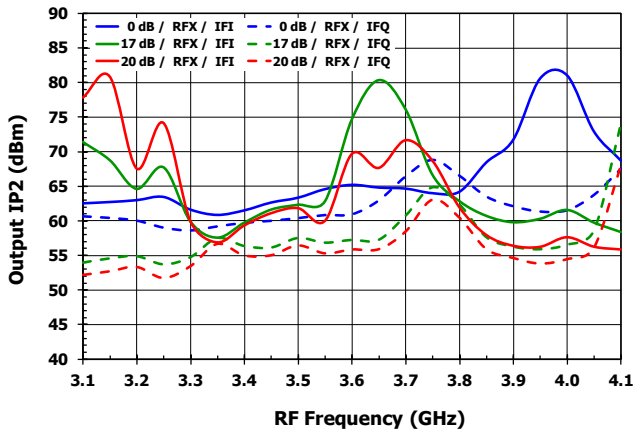

OIP2 vs. Attenuation Setting [Low Side LO, RF<sub>Y</sub>]

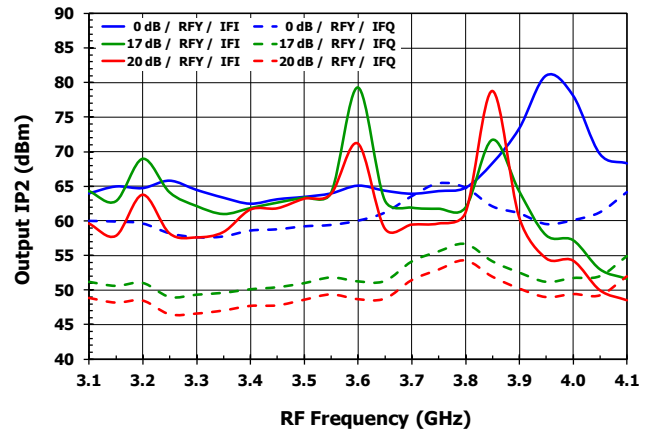

OIP2 vs. Attenuation Setting [High Side LO, RF<sub>X</sub>]

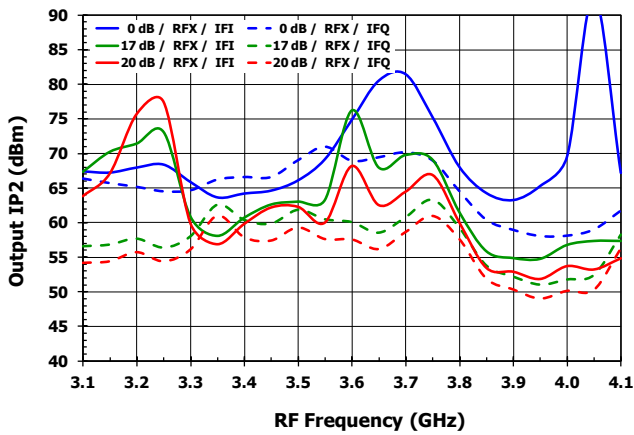

OIP2 vs. Attenuation Setting [High Side LO, RF<sub>Y</sub>]

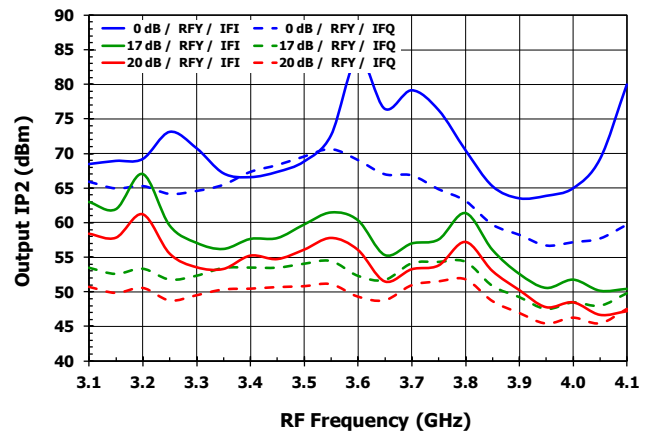



## TYPICAL OPERATING CONDITIONS (- 15 -)

Amplitude Imbalance vs  $T_{Ambient}$  [ $P_{LO} = 0$  dBm]

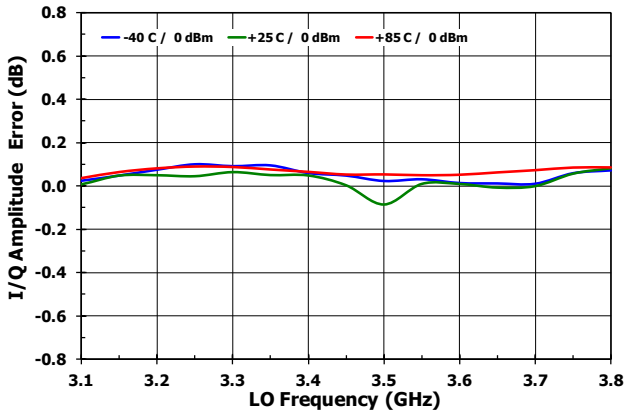

Phase Imbalance vs  $T_{Ambient}$  [ $P_{LO} = 0$  dBm]

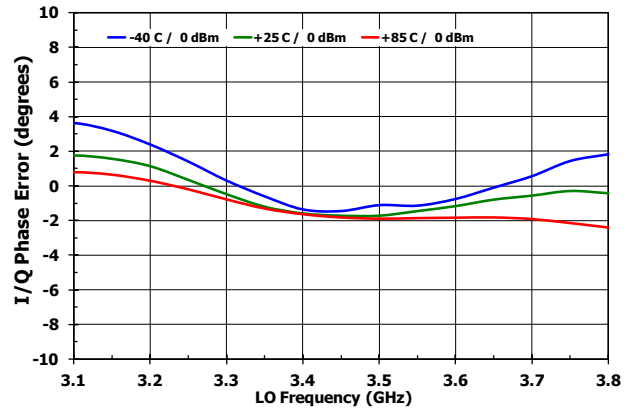

Amplitude Imbalance vs LO Power [ $T_{Ambient}$ ]

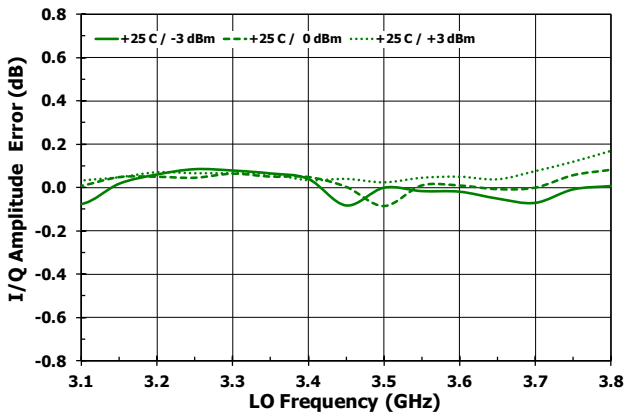

Phase Imbalance vs LO Power [ $T_{Ambient}$ ]

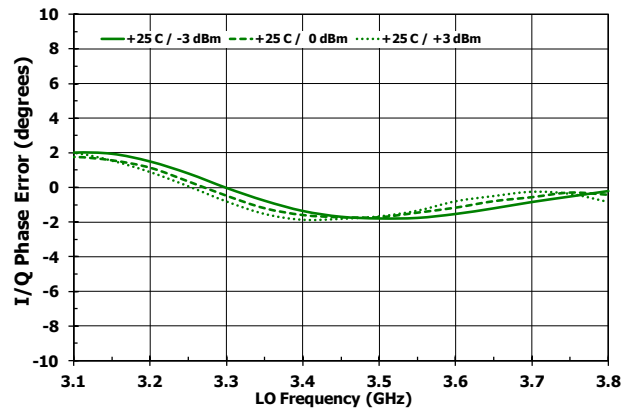

## TYPICAL OPERATING CONDITIONS (- 16 -)

Amplitude Imbalance [ $F_{LO} = 3.155 \text{ GHz}$ ]

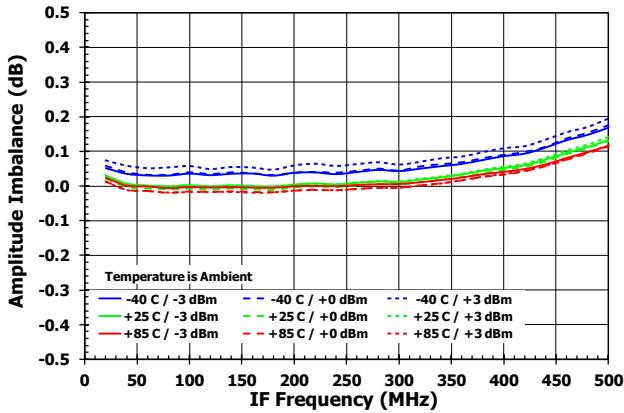

Phase Imbalance [ $F_{LO} = 3.155 \text{ GHz}$ ]

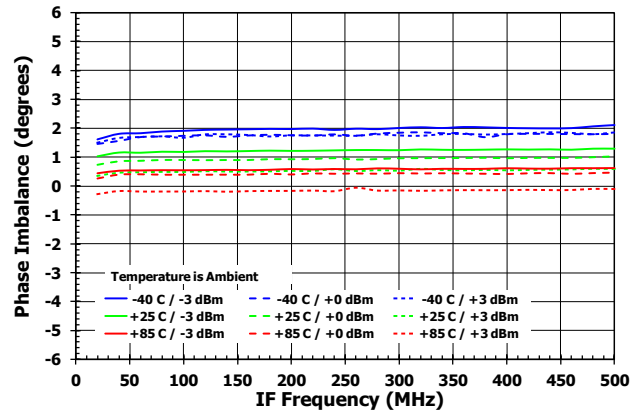

Amplitude Imbalance [ $F_{LO} = 3.255 \text{ GHz}$ ]

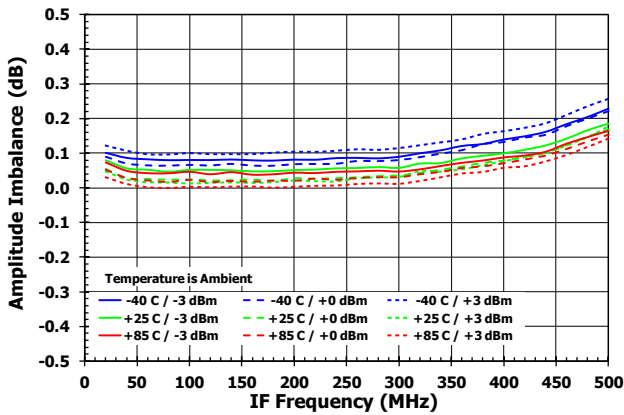

Phase Imbalance [ $F_{LO} = 3.255 \text{ GHz}$ ]

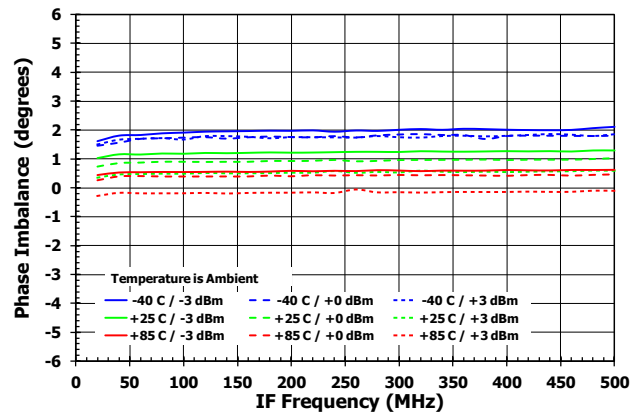

Noise Figure [ $F_{LO}=3.48 \text{ GHz}$ ]

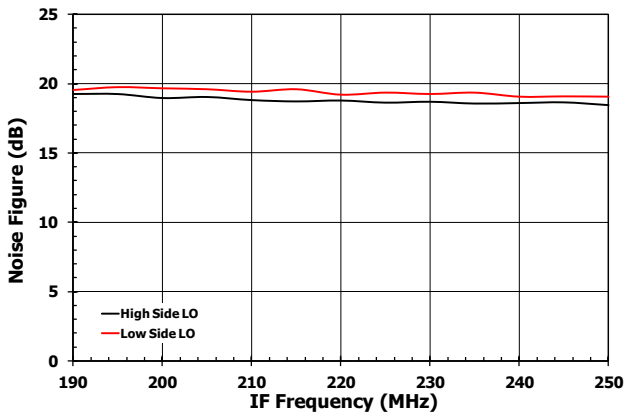

## TYPICAL OPERATING CONDITIONS (- 17 -)

### LO to IF Leakage vs. $T_{case}$ [Low Side LO]

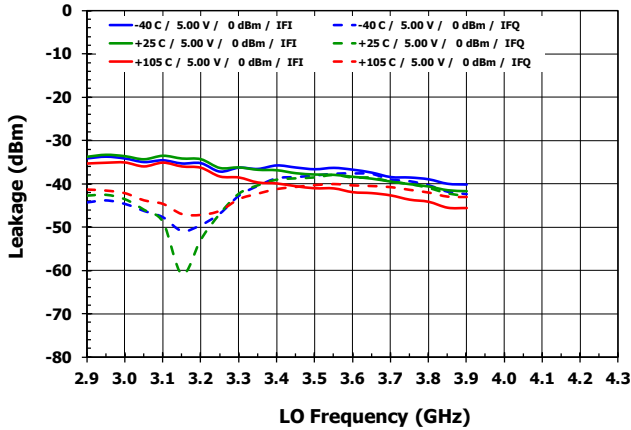

### LO to IF Leakage vs. $T_{case}$ [High Side LO]

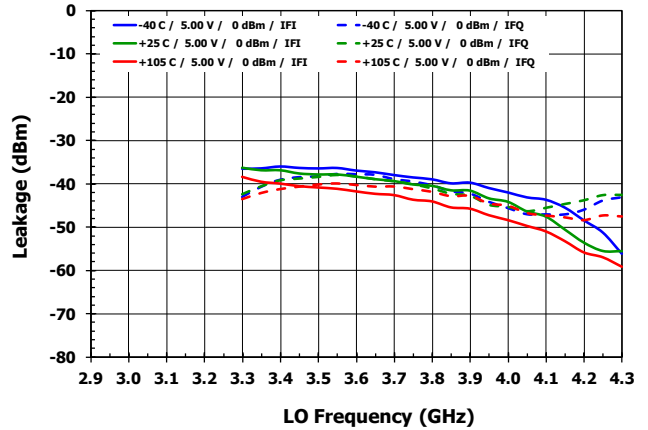

### LO to IF Leakage vs. $V_{cc}$ [Low Side LO]

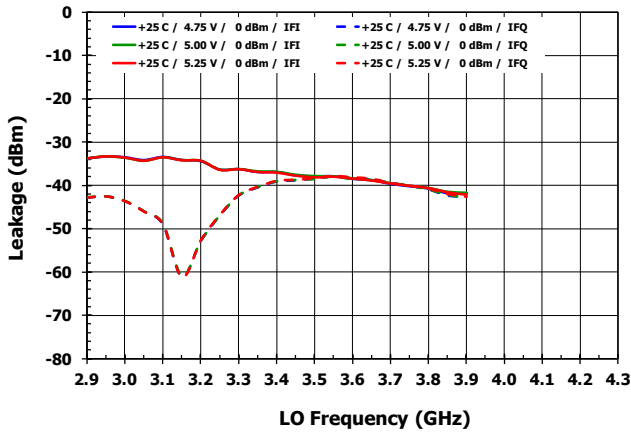

### LO to IF Leakage vs. $V_{cc}$ [High Side LO]

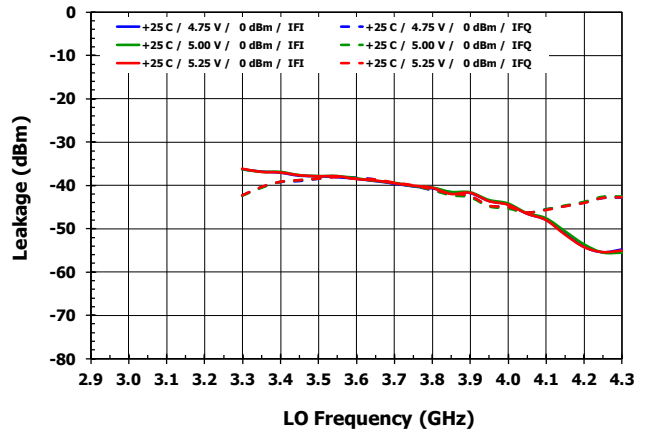

### LO to IF Leakage vs. LO Power [Low Side LO]

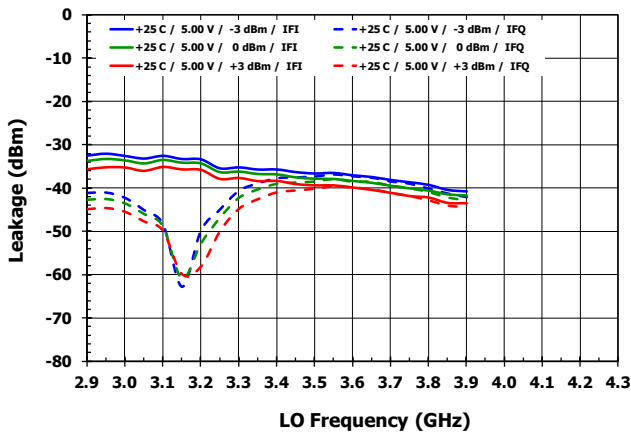

### LO to IF Leakage vs. LO Power [High Side LO]

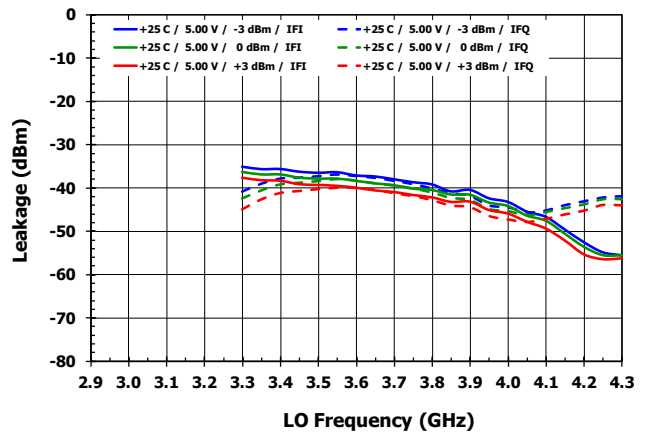

## TYPICAL OPERATING CONDITIONS (- 18 -)

### RF<sub>X</sub> to IF Isolation

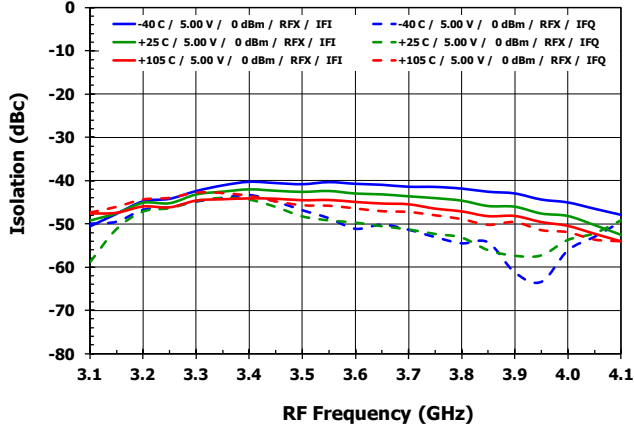

### RF Match

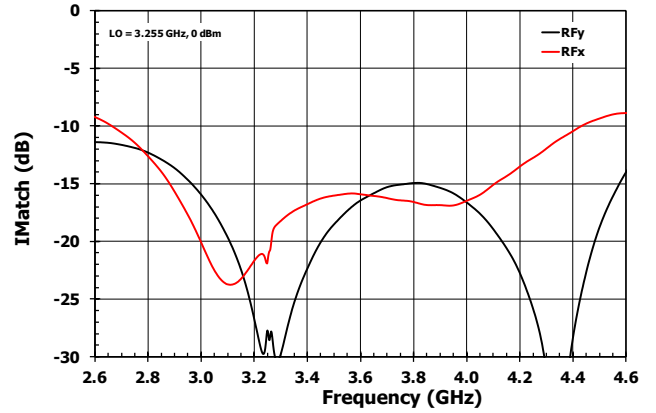

### RF<sub>Y</sub> to IF Isolation

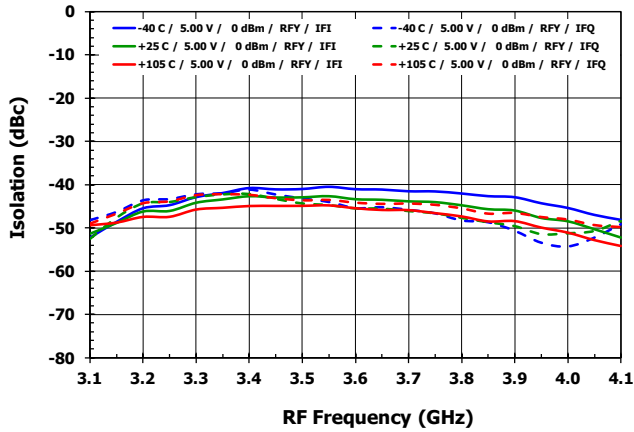

### LO Match

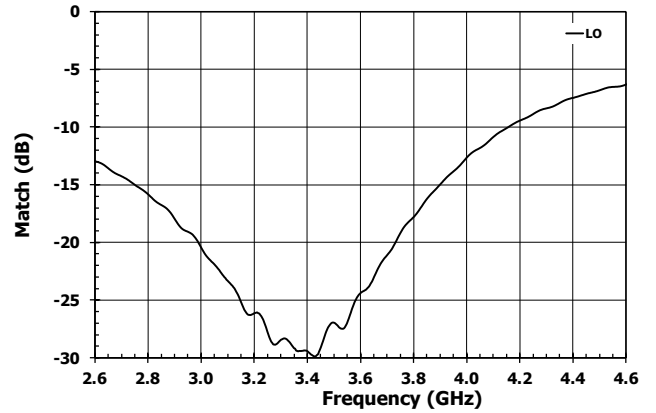

### RF Switch Isolation

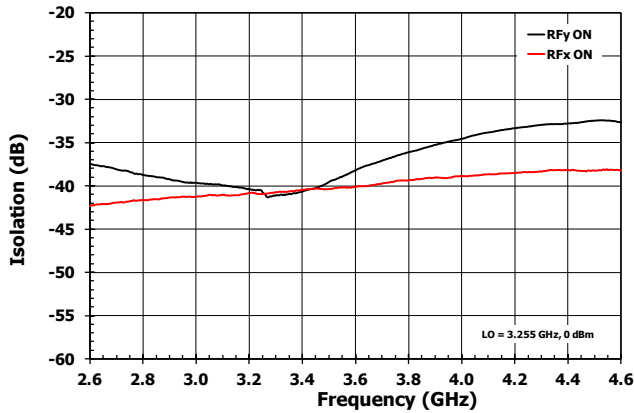

### IF Match

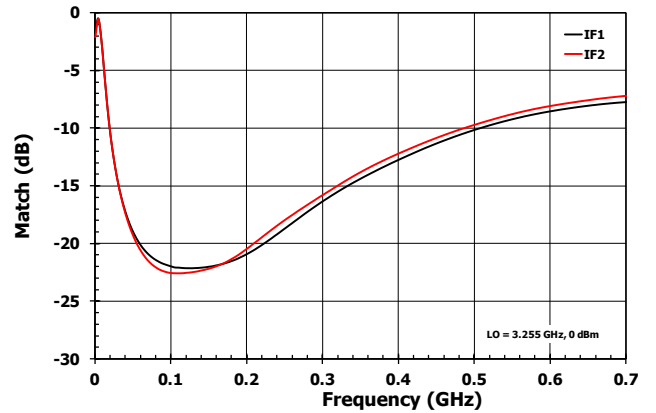

## PACKAGE DRAWING

(6mm x 6mm 36-pin TQFN), NBG36 EPad option P1

All dimensions are in mm.

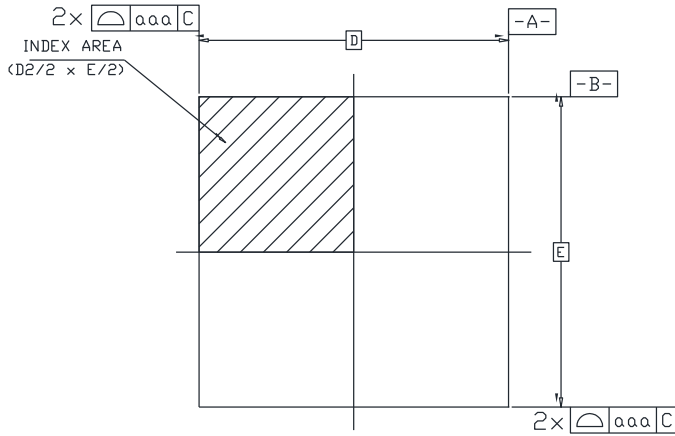

TOP VIEW

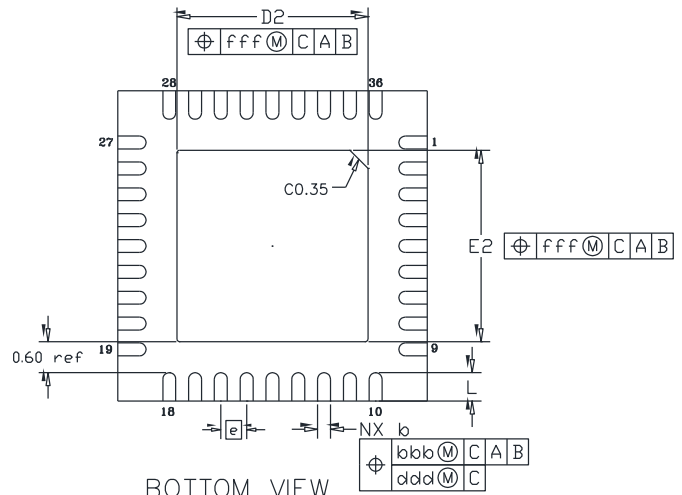

BOTTOM VIEW

SYMBOL	DIMENSION		
	MIN	NOM	MAX
L	0.45	0.55	0.65
D	6.00 BSC		
E	6.00 BSC		
e	0.50 BSC		
A	0.70	0.75	0.80
A1	0.00	0.02	0.05
b	.20	.25	.30
aaa	0.15		
bbb	0.10		
ccc	0.10		
ddd	0.05		
eee	0.08		
fff	0.10		



SIDE VIEW

### EPAD OPTION

SYMBOL	P1			P2		
	MIN	NOM	MAX	MIN	NOM	MAX
E2	3.60	3.70	3.80	4.00	4.10	4.20
D2	3.60	3.70	3.80	4.00	4.10	4.20

### NOTES:

1. ALL DIMENSIONING AND TOLERANCING CONFORM TO ANSI Y14.5M-1982
2. ALL DIMENSIONS ARE IN MILLIMETERS.

## LAND PATTERN DIMENSION

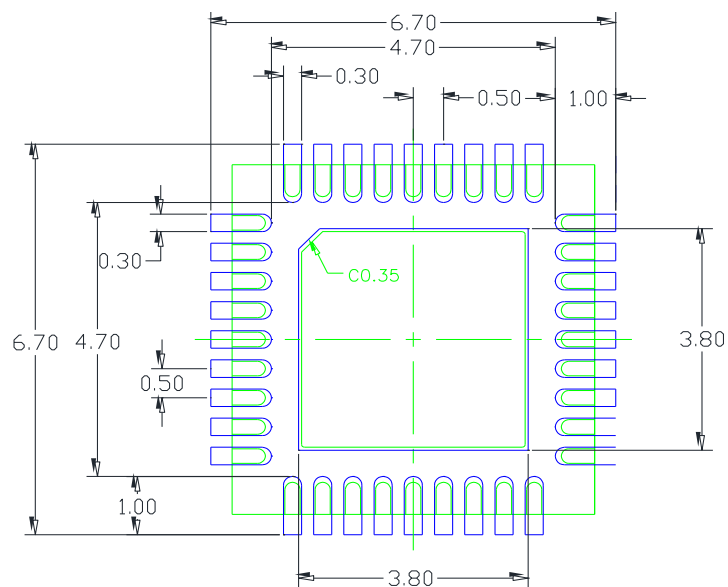

RECOMMENDED LAND PATTERN DIMENSION

NOTES:

1. ALL DIMENSION ARE IN mm. ANGLES IN DEGREES.
2. TOP DOWN VIEW, AS VIEWED ON PCB.
3. COMPONENT OUTLINE SHOW FOR REFERENCE IN GREEN.
4. LAND PATTERN IN BLUE. NSMD PATTERN ASSUMED.
5. LAND PATTERN RECOMMENDATION PER IPC-7351B GENERIC REQUIREMENT FOR SURFACE MOUNT DESIGN AND LAND PATTERN.

## PIN DIAGRAM

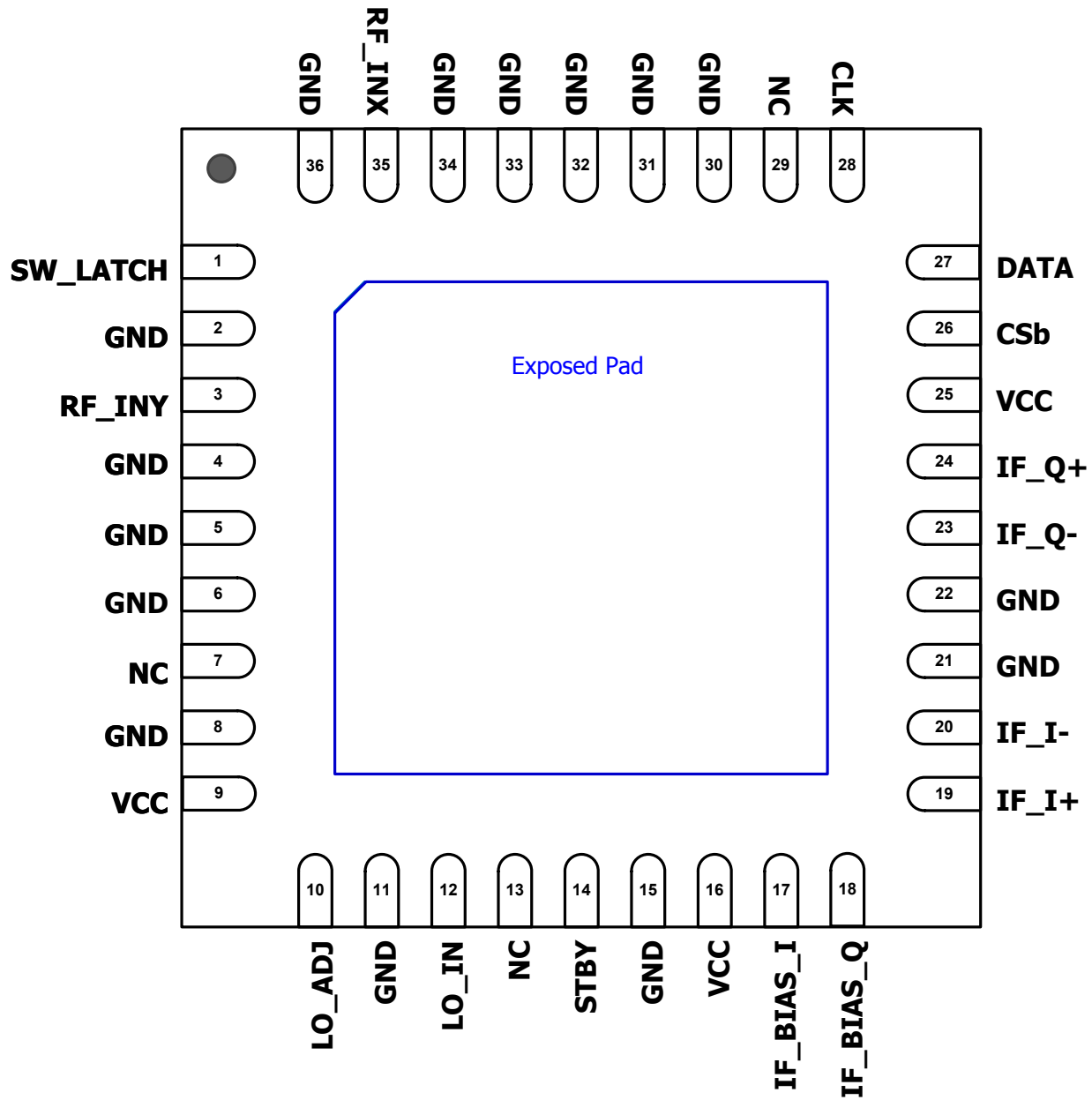

## PIN DESCRIPTION

Pin	Name	Function
1	SW_LATCH	Stand-by latch. Pull Low or Ground for Normal Operation. If left floating, this input will be internally pulled high, disabling SPI writes to ENb (Standby) and RF SW bits (A0, A2).
2, 4, 5, 6, 8, 11, 15, 21, 22, 30, 31, 32, 33, 34, 36	GND	Ground these Pins.
3	RF_INY	Alternate RF Input. Separated from RF_INX by internal SP2T. AC couple to this pin. This is a reflective switch and is not internally matched to 50 ohms.
9, 16, 25	VCC	Power Supply. Bypass to GND with capacitors shown in the Typical Application Circuit as close as possible to pin.
10	LO_ADJ	Connect the specified resistor from this pin to ground to set the LO path $I_{CC}$ . This IS a current setting resistor
12	LO_IN	LO Input. AC couple to this pin. Internally matched to 50 ohms
7, 13, 29	NC	No Connection. Not internally connected. OK to connect to Vcc. Recommended Connection is Ground
14	STBY	STBY Mode. Pull this pin high for Standby mode (30mA). Pull low or Ground for normal Operation
17, 18	IF_BIAS_I IF_BIAS_Q	Connect the specified resistor from this pin to ground to set the IF amplifier bias reference. This is NOT a current setting resistor.
19, 20	IF_I+ IF_I-	<i>In-Phase</i> Mixer Differential IF Output. Connect pull-up inductors from each of these pins to V <sub>CC</sub> (see the Typical Application Circuit).
23, 24	IF_Q- IF_Q+	<i>Quadrature</i> Mixer Differential IF Output. Connect pull-up inductors from each of these pins to V <sub>CC</sub> (see the Typical Application Circuit).
26	CSb	Chip Select Bar. The falling edge initiates a programming cycle and the rising edge latches the programmed shift register data into the active register.
27	DATA	Serial Data Input
28	CLK	Serial Clock Input
35	RF_INX	Main RF Input. Separated from RF_INY by internal SP2T. AC couple to this pin. This is a reflective switch and is not internally matched to 50 ohms.
	— EP	Exposed Pad. Internally connected to GND. Solder this exposed pad to a PCB pad that uses multiple ground vias to provide heat transfer out of the device into the PCB ground planes. These multiple via grounds are also required to achieve the noted RF performance.



## EVKIT PICTURE

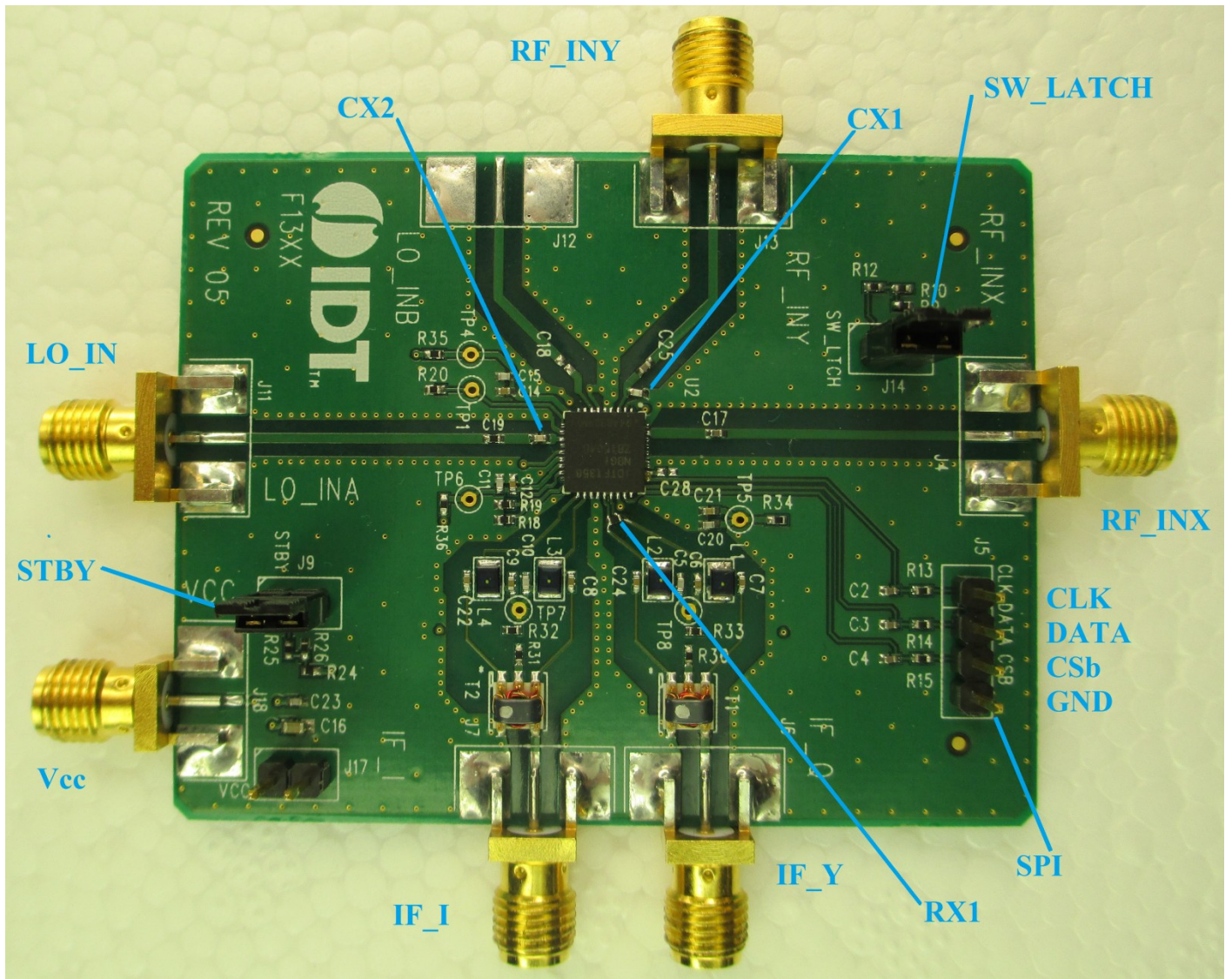

Note: Our standard evaluation board is modified with components RX1, CX1, and CX2

## EVKIT / APPLICATIONS CIRCUIT

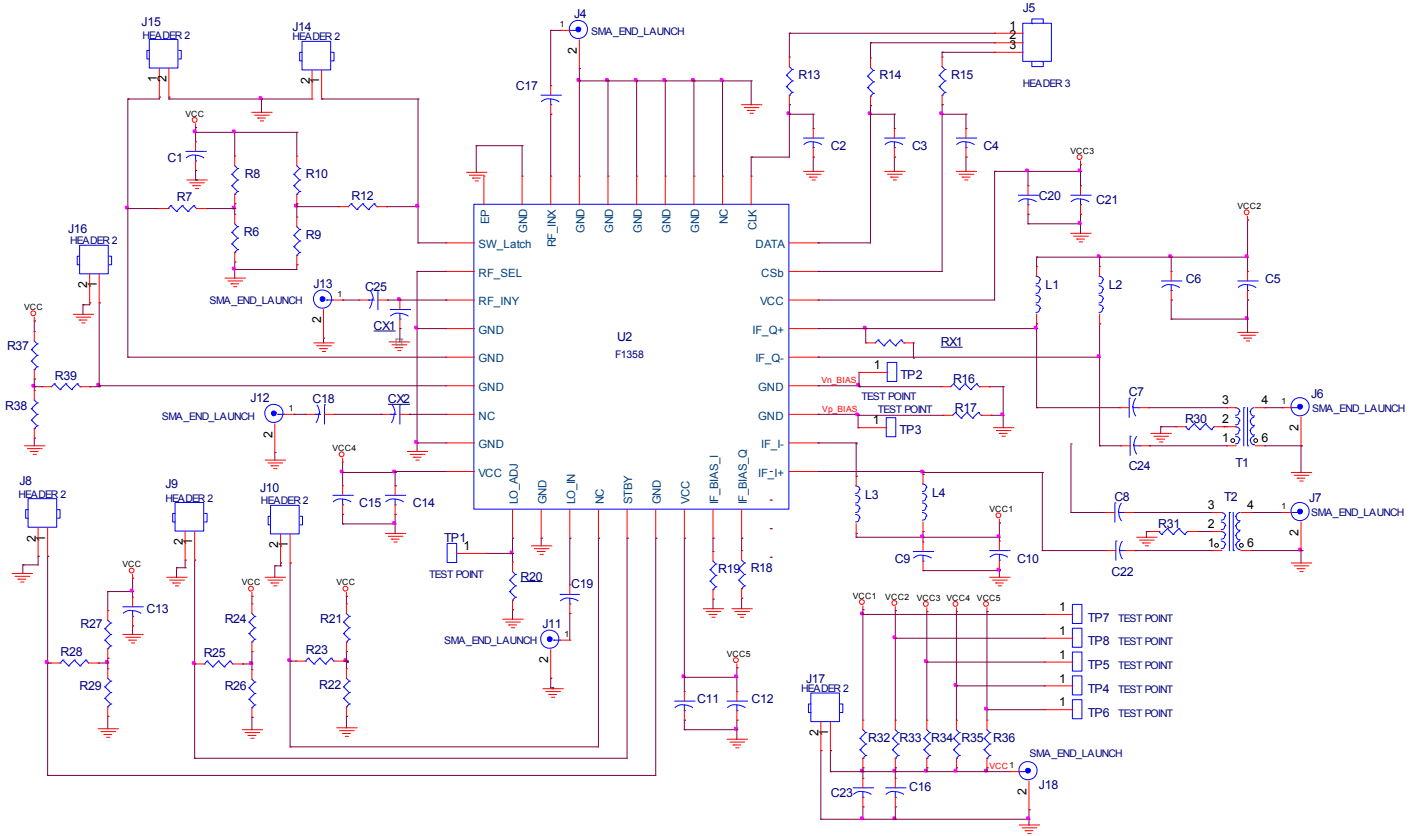

## EVKIT BOM

Item #	Part Reference	QTY	DESCRIPTION	Mfr. Part #	Mfr.
1	C2, C3, C4	3	100pF ±5%, 50V, COG Ceramic Capacitor (0402)	GRM1555C1H101J	MURATA
2	C6, C7, C8, C9, C12, C14, C21, C22, C24	9	10nF ±5%, 50V, X7R Ceramic Capacitor (0402)	GRM155R71H103J	MURATA
3	C5, C10, C11, C15, C20, C23	6	1000pF ±5%, 50V, COG Ceramic Capacitor (0402)	GRM1555C1H102J	MURATA
4	C17, C25	2	39pF ±5%, 50V, COG Ceramic Capacitor (0402)	GRM1555C1H390J	MURATA
5	C16	1	10uF ±20%, 6.3V, X5R Ceramic Capacitor (0603)	GRM188R60J106M	MURATA
6	CX1	1	0.4pF ±0.05pF, 50V, COG Ceramic Capacitor (0402)	GRM1555C1HR40W	MURATA
7	CX2	1	0.8pF ±0.05pF, 50V, COG Ceramic Capacitor (0402)	GJM1555C1HR80W	MURATA
8	R30, R31, R32, R33, R34, R35, C19	7	0Ω Resistors (0402)	ERJ-2GE0R00X	Panasonic
9	R36	1	20Ω ±1%, 1/10W, Resistor (0402)	ERJ-2RKF20R0X	Panasonic
10	R13, R14, R15	3	100Ω ±1%, 1/10W, Resistor (0402)	ERJ-2RKF1000X	Panasonic
11	R18, R19	2	226Ω ±1%, 1/10W, Resistor (0402)	ERJ-2RKF2260X	Panasonic
12	R20	1	4.3kΩ ±1%, 1/10W, Resistor (0402)	ERJ-2RKF4301X	Panasonic
13	R10, R,24	2	43kΩ ±1%, 1/10W, Resistor (0402)	ERJ-2RKF4302X	Panasonic
14	R12, R25	2	47kΩ ±1%, 1/10W, Resistor (0402)	ERJ-2RKF4702X	Panasonic
15	R9, R26	2	75kΩ ±1%, 1/10W, Resistor (0402)	ERJ-2RKF7502X	Panasonic
16	RX1	1	7.5kΩ ±1%, 1/10W, Resistor (0402)	ERJ-2RKF7501X	Panasonic
17	J9, J14, J17	3	CONN HEADER VERT SGL 2 X 1 POS GOLD	961102-6404-AR	3M
18	J5	1	CONN HEADER VERT SGL 4 X 1 POS GOLD	961104-6404-AR	3M
19	J6, J7, J18	3	Edge Launch SMA (0.250 inch pitch ground, round)	142-0711-821	Emerson Johnson
20	J4, J11, J13	3	Edge Launch SMA (0.375 inch pitch ground, tab)	142-0701-851	Emerson Johnson
21	L1, L2, L3, L4	4	1uH ±5%, .500A, Ferrite Chip Inductor (0805)	0805LS-102XJLB	COILCRAFT
22	T1, T2	2	1.5-600Mhz 50Ω, RF Transformer (4:1)	TC4-6TG2+	Mini Circuits
23	U1	1	DPD Demodulator	F1358	IDT
24		1	Printed Circuit Board	F13XX REV 05	IDT
25		1	Bill Of Material (Rev 02)		IDT

## TOP MARKINGS

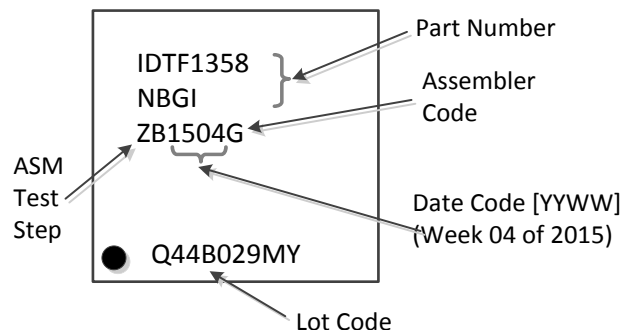

## APPLICATIONS INFORMATION

F1358 has been optimized for use in high performance RF applications from 3200 MHz to 4000 MHz.

### Matching Components

For proper optimization three components were added and one was removed from our standard evaluation board.

Component	Value	Component
RX1	7.5 k $\Omega$	
CX1	0.4 pF	This shunt capacitor is used to create an better match on the second RF input line.
CX2	0.8 pF	This series capacitor must be as close to the package as possible for the best possible match on the LO port.
C18	0 $\Omega$	For better return loss the capacitor was moved closer to the package (CX2). This position was filled with a 0 ohm resistor to span the component gap.

### Power Supplies

All supply pins should be bypassed with external capacitors to minimize noise and fast transients. Supply noise can degrade noise figure and fast transients can trigger ESD clamps and cause them to fail. Supply voltage change or transients should have a slew rate smaller than 1V over 20  $\mu$ S (< 0.05 V/  $\mu$ S). In addition, all control pins should remain at 0V (+/-0.3V) while the supply voltage ramps or while it returns to zero.

### F1358 Digital Pin Voltage & Resistance Values (pins not connected)

The following table lists the resistance between various pins and ground when no DC power is applied. When the device is powered up with +5 Volts DC these same pins to should have the measured voltage to ground.

Pin	Name	DC voltage (volts)	Resistance (ohms)
1	SW_LATCH	1.75	1.6M
14	STBY	5.0	50k
26	CSb	1.75	1.6M
27	DATA	1.75	1.6M
28	CLK	1.75	1.6M



### **I/Q Phase Error**

The standard configuration results in less than 4 degrees of I/Q Phase error with LO frequencies from 3100 to 3800 MHz. The I/Q phase error can be further improved for a given LO frequency via applications changes. Please contact [RFsupport@idt.com](mailto:RFsupport@idt.com) for help with your application.

## IMPORTANT NOTICE AND DISCLAIMER

RENESAS ELECTRONICS CORPORATION AND ITS SUBSIDIARIES (“RENESAS”) PROVIDES TECHNICAL SPECIFICATIONS AND RELIABILITY DATA (INCLUDING DATASHEETS), DESIGN RESOURCES (INCLUDING REFERENCE DESIGNS), APPLICATION OR OTHER DESIGN ADVICE, WEB TOOLS, SAFETY INFORMATION, AND OTHER RESOURCES “AS IS” AND WITH ALL FAULTS, AND DISCLAIMS ALL WARRANTIES, EXPRESS OR IMPLIED, INCLUDING, WITHOUT LIMITATION, ANY IMPLIED WARRANTIES OF MERCHANTABILITY, FITNESS FOR A PARTICULAR PURPOSE, OR NON-INFRINGEMENT OF THIRD PARTY INTELLECTUAL PROPERTY RIGHTS.

These resources are intended for developers skilled in the art designing with Renesas products. You are solely responsible for (1) selecting the appropriate products for your application, (2) designing, validating, and testing your application, and (3) ensuring your application meets applicable standards, and any other safety, security, or other requirements. These resources are subject to change without notice. Renesas grants you permission to use these resources only for development of an application that uses Renesas products. Other reproduction or use of these resources is strictly prohibited. No license is granted to any other Renesas intellectual property or to any third party intellectual property. Renesas disclaims responsibility for, and you will fully indemnify Renesas and its representatives against, any claims, damages, costs, losses, or liabilities arising out of your use of these resources. Renesas' products are provided only subject to Renesas' Terms and Conditions of Sale or other applicable terms agreed to in writing. No use of any Renesas resources expands or otherwise alters any applicable warranties or warranty disclaimers for these products.

(Rev.1.0 Mar 2020)

### Corporate Headquarters

TOYOSU FORESIA, 3-2-24 Toyosu,  
Koto-ku, Tokyo 135-0061, Japan  
[www.renesas.com](http://www.renesas.com)

### Contact Information

For further information on a product, technology, the most up-to-date version of a document, or your nearest sales office, please visit:  
[www.renesas.com/contact/](http://www.renesas.com/contact/)

### Trademarks

Renesas and the Renesas logo are trademarks of Renesas Electronics Corporation. All trademarks and registered trademarks are the property of their respective owners.

## X-ON Electronics

Largest Supplier of Electrical and Electronic Components

*Click to view similar products for [Modulator/Demodulator](#) category:*

*Click to view products by [Renesas](#) manufacturer:*

Other Similar products are found below :

[LC72722PM-TLM-E](#) [HMC495LP3TR](#) [LT5571EUF#PBF](#) [LT5528EUF#PBF](#) [LT5502EGN#PBF](#) [THAT1510S08-U](#) [CMX589AD5](#)  
[ADRF6821ACPZ](#) [AD630ADZ](#) [AD630ARZ](#) [AD630JNZ](#) [AD630KNZ](#) [AD8346ARUZ-REEL7](#) [AD8339ACPZ](#) [AD8345ARE](#) [AD8345AREZ](#)  
[AD8345AREZ-RL7](#) [AD8347ARUZ](#) [AD8347ARUZ-REEL7](#) [AD8348ARUZ](#) [AD8348ARUZ-REEL7](#) [AD8349AREZ](#) [AD8349AREZ-RL7](#)  
[ADL5371ACPZ-R7](#) [ADL5387ACPZ-WP](#) [ADL5387ACPZ-R7](#) [ADL5372ACPZ-R7](#) [ADL5373ACPZ-R7](#) [ADA2200ARUZ-REEL7](#)  
[AD8346ARUZ](#) [ADL5380-EVALZ](#) [ADL5382ACPZ-R7](#) [AD630ARZ-RL](#) [ADL5375-15ACPZ-R7](#) [ADL5380ACPZ-R7](#) [ADL5375-05ACPZ-R7](#)  
[AD8333ACPZ-WP](#) [AD8341ACPZ-REEL7](#) [ADRF6703ACPZ-R7](#) [ADRF6750ACPZ-R7](#) [ADRF6806ACPZ-R7](#) [HMC1097LP4E](#)  
[HMC630LP3ETR](#) [HMC500LP3ETR](#) [HMC495LP3ETR](#) [HMC500LP3E](#) [HMC630LP3E](#) [HMC631LP3E](#) [HMC795LP5E](#) [LTC5598IUF](#)