

GENERAL DESCRIPTION

This document describes the specification for the IDTF1701 Zero-Distortion™ Lowband RF to IF Single Downconverting Mixer. This device is part of a series of mixers using lowside or highside LO injection options for all UTRA frequency bands. See the Part# Matrix for the detail of all devices in this series.

The F1701 single channel device is designed to operate with a single 5V supply. It is optimized for operation in a Multi-mode, Multi-carrier BaseStation Receiver over the frequency range from 600MHz to 1060MHz using either lowside or highside LO. IF frequencies from 70MHz to 300MHz are supported. Nominally, the device offers +43dBm Output IP3 using HS LO with 184mA of I_{cc} .

COMPETITIVE ADVANTAGE

In typical basestation receivers, the RF to IF mixer dominates the linearity performance for the entire receive system. The Zero-Distortion™ family of mixers dramatically improve the maximum signal levels (IM_3 tones) that the BTS can withstand at a desired Signal to Noise Ratio (SNR.) Zero-Distortion™ technology allows realization of either benefit. In basestation transmitters, digital pre-distortion (DPD) is employed to improve the Transmitter performance. By utilizing an ultra-linear mixer in the DPD RX path, such as the IDTF1701, the ACLR and/or power consumption of the full Tx system can be improved significantly. This is because the F1701 can directly drive an ADC through an Anti-Alias filter. Downstream amplification is not necessary in the DPD application.

- ✓ $IP3_0$: ↑ **9 dB**
- ✓ Dissipation: ↓ **14%**
- ✓ Allows for higher RF gain improving **Sensitivity**
- ✓ Eliminates the need for an ADC driver or IF VGA in DPD linearization path



FEATURES

- Ideal for Multi-Carrier Systems
- Lowside or Highside LO
- 11.8dB Gain
- Ultra linear +43dBm $IP3_0$ using HS LO or +42dBm $IP3_0$ using LS LO
- 9.2dB NF
- 200 Ω output impedance
- Wide flat performance IF BW
- Drives ADC directly for DPD applications
- Low Power Consumption
- 5x5 20 pin package
- Standby Mode

DEVICE BLOCK DIAGRAM

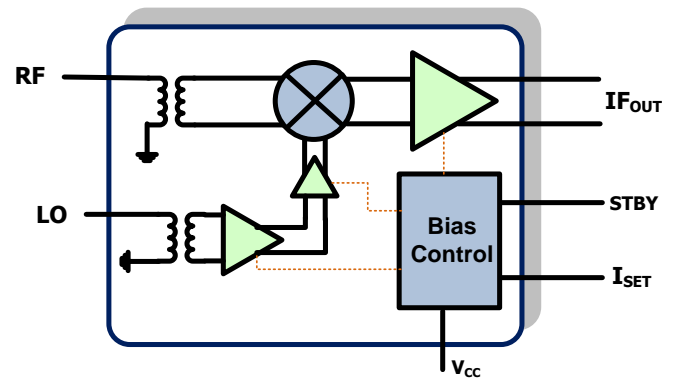

ORDERING INFORMATION

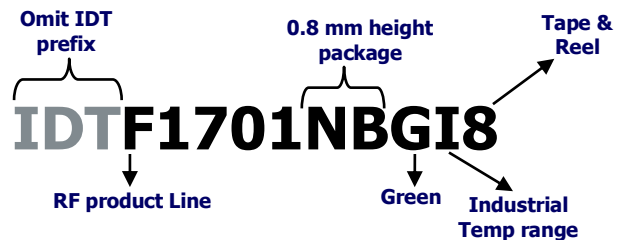

PART# MATRIX

Part#	RF Range	UTRA bands	IF freq range	Typ. Gain	Injection
F1701	600 - 1060	5, 6, 8, 12, 13, 14, 17, 18, 19, 20, 26	70 - 300	11.8	Both
F1751	1400 - 2500	1, 2, 3, 4, 9, 10, 11, 21, 23, 24, 25, 33, 34, 35, 36, 37, 39, 40	50 - 500	11.8	Both
F1763	2000 - 2900	7, 38, 40, 41	50 - 500	11.7	Both

ABSOLUTE MAXIMUM RATINGS

VCC to GND	-0.3V to +5.5V
STBY	-0.3V to (VCC + 0.3V)
IF_OUT+, IF_OUT-, RF_IN	-0.3V to (VCC + 0.3V)
LO_IN	-0.3V to +0.3V
IF_SET to GND, IF_BIAS to GND	-0.3V to +1.2V
RF Input Power	+20dBm
Continuous Power Dissipation	1.3W
θ_{JA} (Junction – Ambient)	+40°C/W
θ_{JC} (Junction – Case) The Case is defined as the exposed paddle	+3°C/W
Operating Temperature Range (Case Temperature)	$T_C = -40^\circ\text{C}$ to $+105^\circ\text{C}$
Maximum Junction Temperature	150°C
Storage Temperature Range	-65°C to +150°C
Lead Temperature (soldering, 10s)	+260°C

Stresses above those listed above may cause permanent damage to the device. Functional operation of the device at these or any other conditions above those indicated in the operational section of this specification is not implied. Exposure to absolute maximum rating conditions for extended periods may affect device reliability.

IDTF1701 RECOMMENDED OPERATING CONDITIONS

Parameter	Comment	Symbol	min	typ	max	Units
Supply Voltage(s)	All V _{CC} pins	V _{CC}	4.75		5.25	V
Operating Temperature Range	Case Temperature	T _{CASE}	-40		+105	degC
RF Freq Range	Sets LO freq range	F _{RF1}	698		960	MHz
Oversample RF Range	<ul style="list-style-type: none"> ▪ Measure gain at 200MHz IF ▪ FLO = 800MHz, 1260MHz 	F _{RF2}	600		1060	
LO Freq Range			630		1260	
IF Freq Range	Sets LO freq range	F _{IF}	70		300	

IDTF1701 SPECIFICATION

Refer to Typical Application Circuit when operated with $V_{CC} = +5.0V$, $T_C = +25^\circ C$, $F_{RF} = 950\text{ MHz}$, $F_{IF} = 200\text{ MHz}$, $F_{LO} = 1150\text{ MHz}$, $P_{LO} = 0\text{ dBm}$, output power = +1dBm per tone, STBY = GND unless otherwise noted. Transformer loss is de-embedded unless otherwise noted.

Parameter	Comment	Symbol	min	typ	max	units
Logic Input High	For Standby Pin	V_{IH}	2			V
Logic Input Low	For Standby Pin	V_{IL}			0.8¹	V
Logic Current	For Standby Pin	I_{IH}, I_{IL}	-1		+1	μA
Supply Current	Total V_{CC}	I_{SUPP}		184	210	mA
Supply Current	Standby Mode ▪ STBY = V_{IH}	I_{STBY}		20	25	mA
LO Power		P_{LO}	-3²		+3	dBm
Settling Time	<ul style="list-style-type: none"> • Pin = -13 dBm • Gate STBY from V_{IH} to V_{IL} • Time for IF Signal to settle to within 1 dB of final value 	T_{SETT}		130		nsec
Gain	<ul style="list-style-type: none"> ▪ $F_{RF} = 600\text{MHz}$ ▪ $F_{LO} = 800\text{MHz}$ 	G_{LB}		11.3		dB
	<ul style="list-style-type: none"> ▪ $F_{RF} = 950\text{MHz}$ ▪ $F_{LO} = 1150\text{MHz}$ 	G_{MB}	10.9	11.8	12.6	
	<ul style="list-style-type: none"> ▪ $F_{RF} = 1060\text{MHz}$ ▪ $F_{LO} = 1260\text{MHz}$ 	G_{HB}		11.4		
Noise Figure		NF		9.2		dB
NF w/Blocker	<ul style="list-style-type: none"> ▪ -100 MHz offset blocker ▪ $P_{BLKR} = +4\text{ dBm}$ 	NF_{BLK}		17.5		dB
Output IP3	<ul style="list-style-type: none"> ▪ $F_{RF1} = 950\text{MHz}$ ▪ $F_{LO} = 1150\text{MHz}$ ▪ $P_{IN} = -10\text{dBm}$ per tone ▪ 5MHz Tone Separation 	$IP3_{oHSLO}$	36	43		dBm
	<ul style="list-style-type: none"> ▪ $F_{RF1} = 950\text{MHz}$ ▪ $F_{LO} = 750\text{MHz}$ ▪ $P_{IN} = -10\text{dBm}$ per tone ▪ 5MHz Tone Separation 	$IP3_{oLSLO}$		42		
2RF – 2LO rejection	<ul style="list-style-type: none"> ▪ $P_{RF} = -10\text{dBm}$ ▪ Frequency = 1050MHz 	2x2		-77	-72	dBc
2 nd Harmonic	<ul style="list-style-type: none"> ▪ $P_{out} = -3\text{dBm}$ 	H2		-78	-72	dBc

IDTF1701 SPECIFICATION - CONTINUED

Refer to Typical Application Circuit when operated with $V_{CC} = +5.0V$, $T_C = +25^\circ C$, $F_{RF} = 950$ MHz, $F_{IF} = 200$ MHz, $F_{LO} = 1150$ MHz, $P_{LO} = 0$ dBm, output power = +1dBm per tone, STBY = GND unless otherwise noted. Transformer loss is de-embedded unless otherwise noted.

IM2 Sum Product (IM2+)	<ul style="list-style-type: none"> ▪ Pout = -3 dBm each tone ▪ $F_{IF1} = 200$ MHz, $F_{IF2} = 205$ MHz ▪ IM2 Product = 405 MHz 	IM2+		-75	-69	dBc
IM2 Diff Product (IM2-)	<ul style="list-style-type: none"> ▪ Pout = -3 dBm each tone ▪ $F_{IF1} = 200$ MHz, $F_{IF2} = 205$ MHz ▪ IM2 Product = 5 MHz 	IM2-		-80	-75	dBc
1dB output compression	Output referred	$P1dB_O$	17	21		dBm
1dB input compression	Input referred	$P1dB_I$		10.2		dBm
Gain Comp. w/blocker	<ul style="list-style-type: none"> ▪ Unmodulated blocker ▪ $P_{in} = -4$ dBm, -100MHz offset ▪ Signal Pin Tone = -20dBm ▪ Measure Δ gain of signal 	ΔG_{AC}		0.1	0.15	dB
Gain Ripple	<ul style="list-style-type: none"> ▪ Fixed LO = 1100 MHz ▪ RF = 770 to 1050 MHz ▪ IF = 50 to 330 MHz 			1	1.2	dB
RF Input Impedance	Single Ended	Z_{RF}		50		Ω
LO port Impedance	Single Ended	Z_{LO}		50		
IF Output Impedance	Differential	Z_{IF}		200		
RF Input Return Loss	Single Ended	RF_{RL}	14	20		dB
LO port Return Loss	Single Ended	LO_{RL}	18	22		dB
IF Output Return Loss	Differential	IF_{RL}	17	19		dB
LO to IF leakage ²		ISO_{LI}		-55	-39	dBm
RF to IF leakage	Referenced to Pin = -10dBm	ISO_{RI}		-41	-34	dBc
LO to RF leakage		ISO_{LR}		-43.5	-38	dBm

1 – Items in min/max columns in *bold italics* are Guaranteed by Test

2 – All other Items in min/max columns are Guaranteed by Design Characterization

TYPICAL OPERATING CONDITIONS

Unless otherwise noted, the following conditions apply to the Typ Ops Graphs:

- $V_{CC} = +5.0V$
- $STBY = GND$
- $T_C = +25^{\circ}C$
- $F_{RF} = 950\text{ MHz}$
- $F_{IF} = 200\text{ MHz}$
- $F_{LO} = 1150\text{ MHz}$
- $P_{LO} = 0\text{ dBm}$
- $P_{in} = -10\text{ dBm}$ per tone
- Transformer loss is de-embedded for Gain, Output P1dB and OIP3 Graphs

TOCs [IF = 200MHz, HIGH SIDE INJECTION] Gain, OIP3 (1)

Gain vs. T_{CASE}

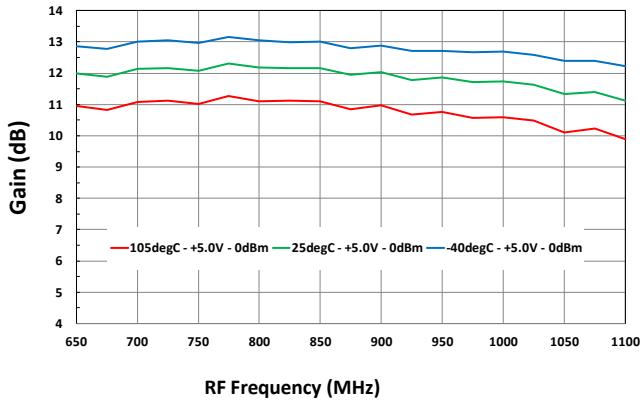

Gain vs. Lo Level

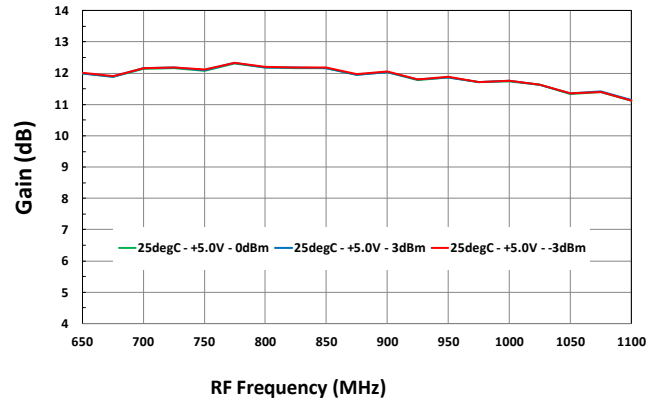

Gain vs. Vcc

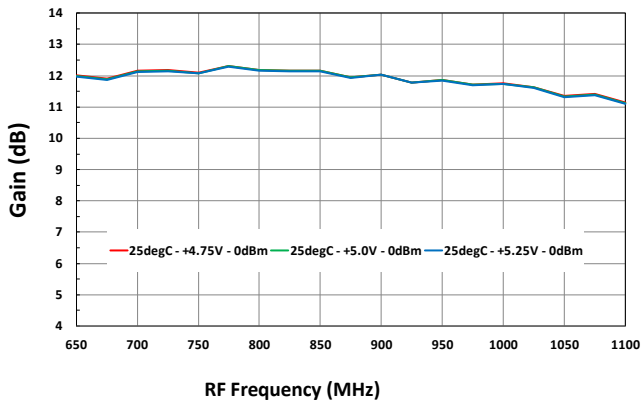

Output IP3 vs. T_{CASE}

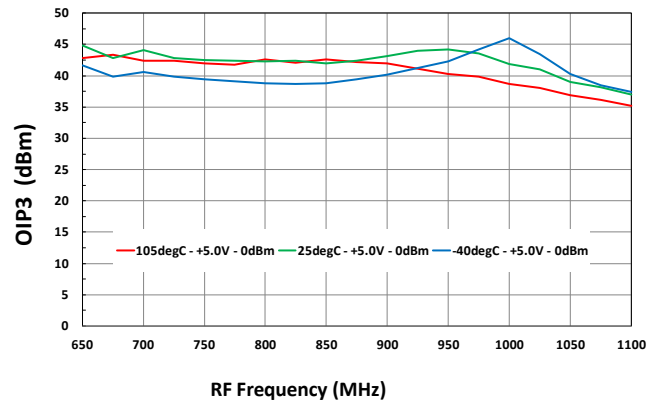

Output IP3 vs. Lo Level

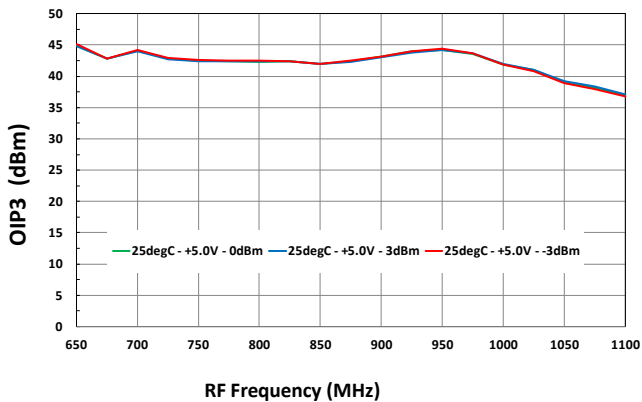

Output IP3 vs. Vcc

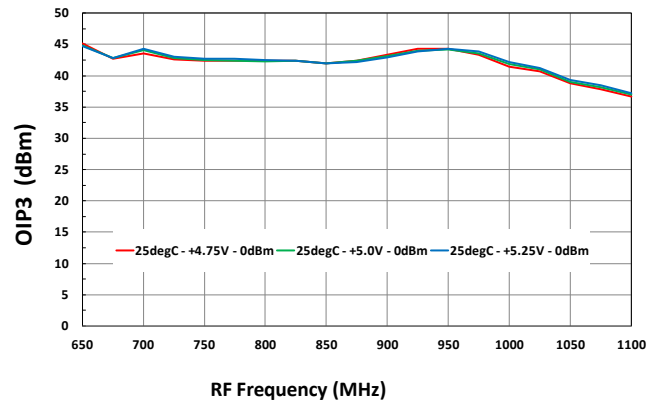

TOCs [IF = 200MHz, HIGH SIDE INJECTION] P1dB_o, 2x2 (2)

P1dB_o vs. T_{CASE}

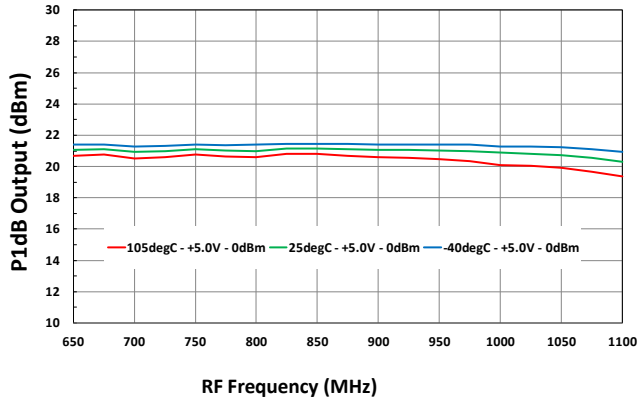

P1dB_o vs. Lo Level

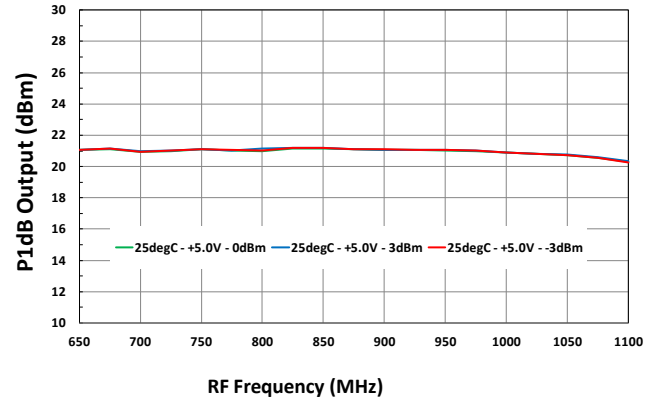

P1dB_o vs. V_{CC}

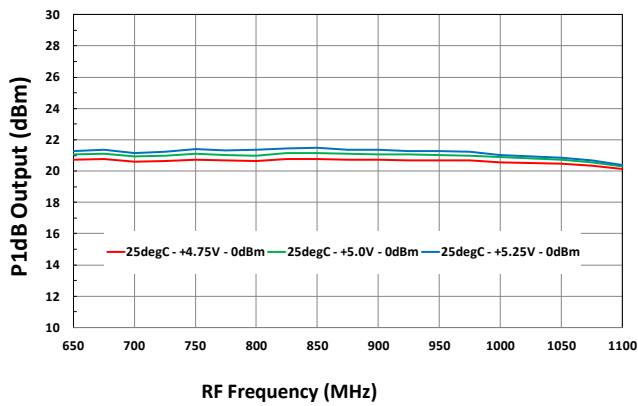

2x2 Rejection vs. T_{CASE}

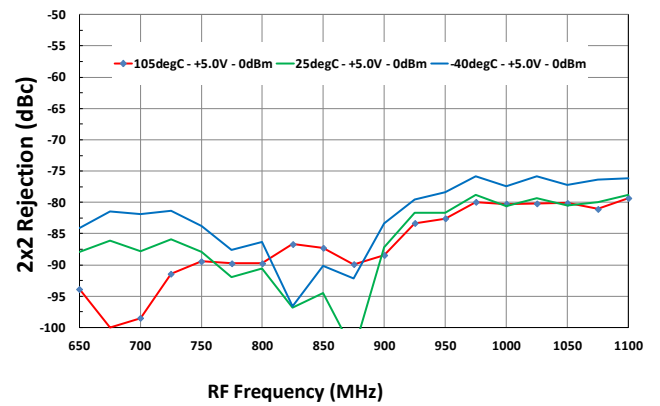

2x2 Rejection vs. Lo Level

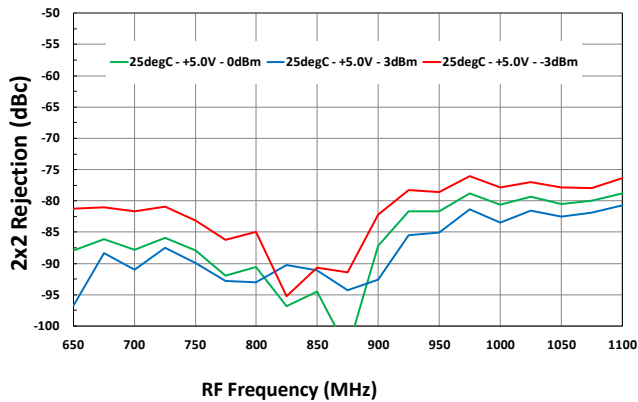

2x2 Rejection vs. V_{CC}

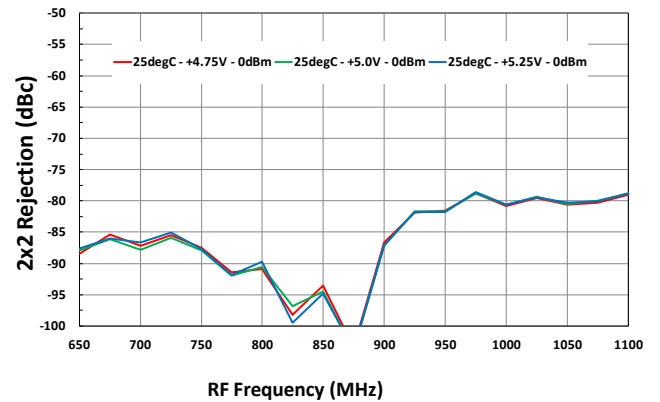

TOCs [IF = 200MHz, HIGH SIDE INJECTION] 3x3, H2 Rejection (3)

3x3 Rejection vs. T_{CASE}

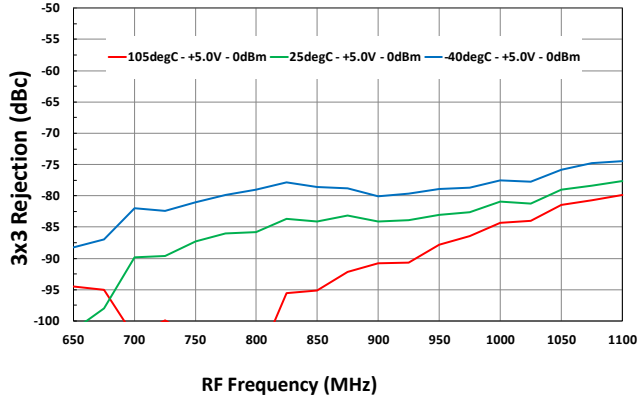

3x3 Rejection vs. Lo Level

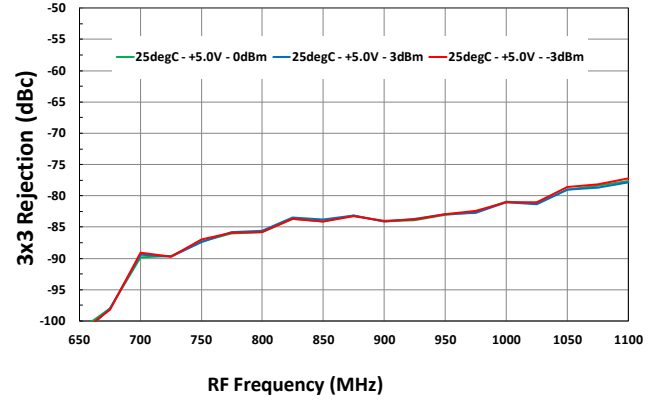

3x3 Rejection vs. V_{cc}

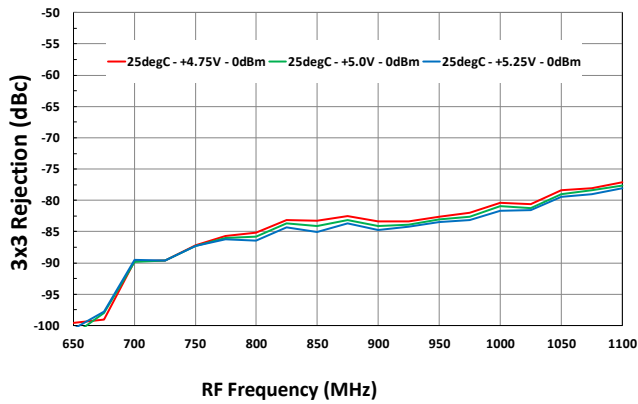

H2 Rejection vs. T_{CASE}

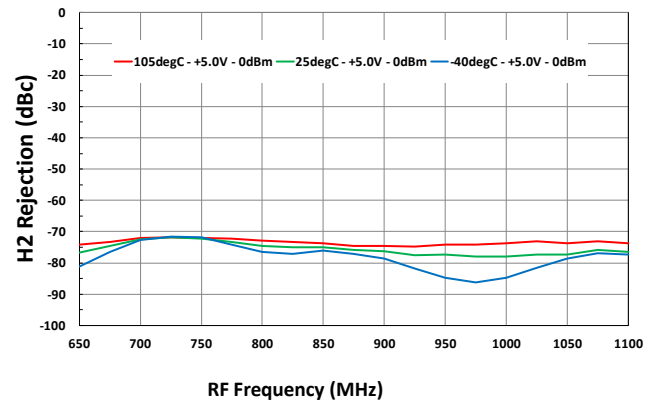

H2 Rejection vs. Lo Level

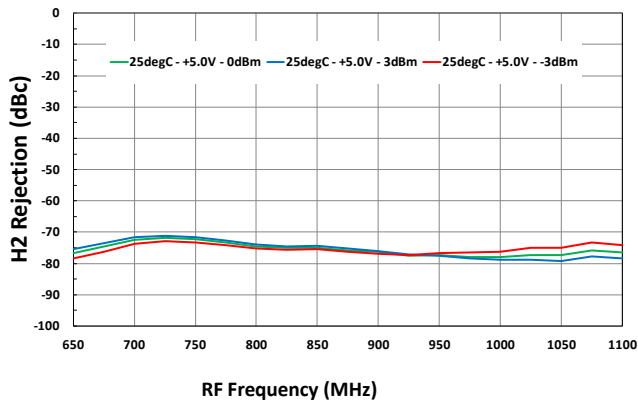

H2 Rejection vs. V_{cc}

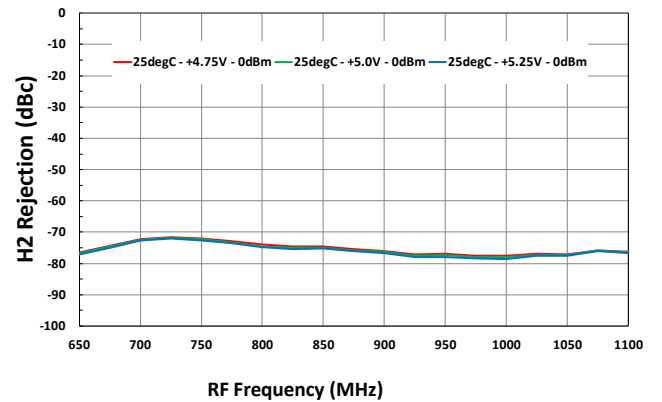

TOCs [IF = 200MHz, HIGH SIDE INJECTION] Icc, LO-IF leakage [4]

ICC vs. T_{CASE}

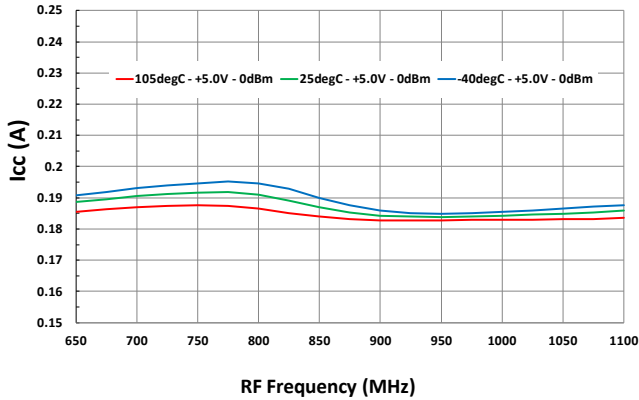

ICC vs. Lo Level

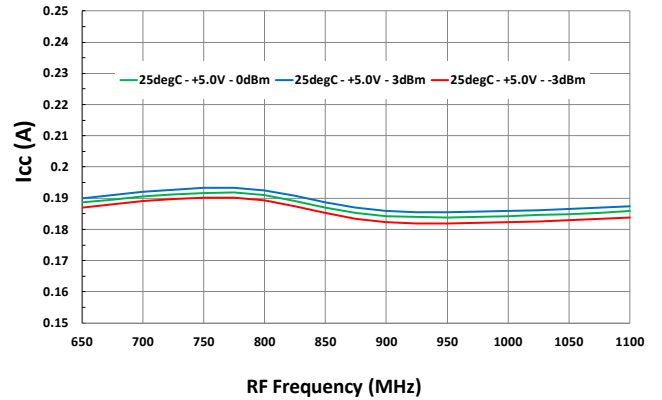

ICC vs. Vcc

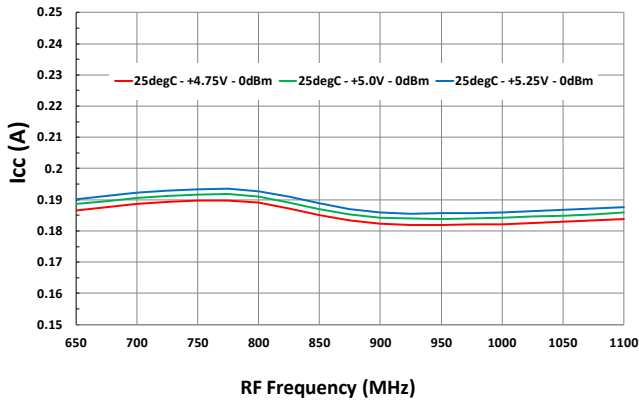

Lo to IF leakage vs. T_{CASE}

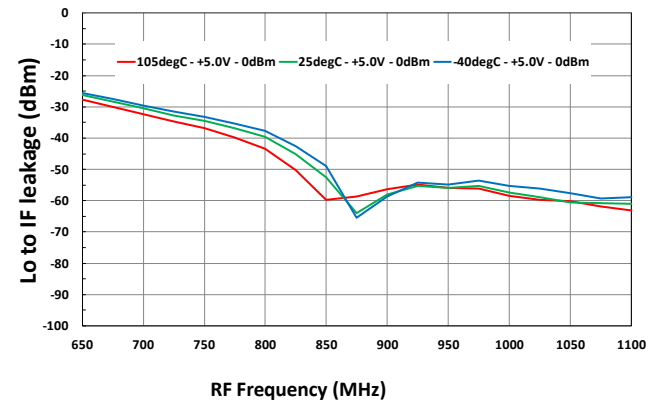

Lo to IF leakage vs. Lo Level

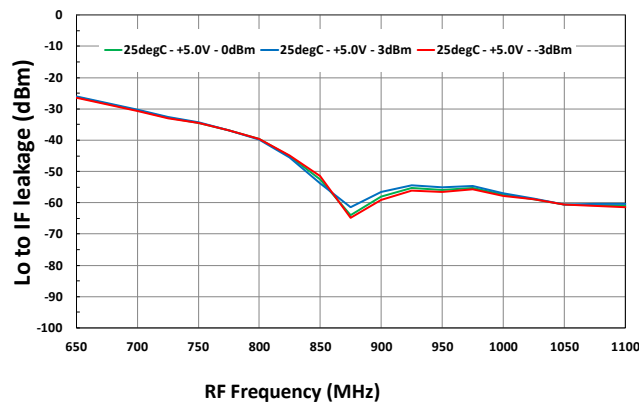

Lo to IF leakage vs. Vcc

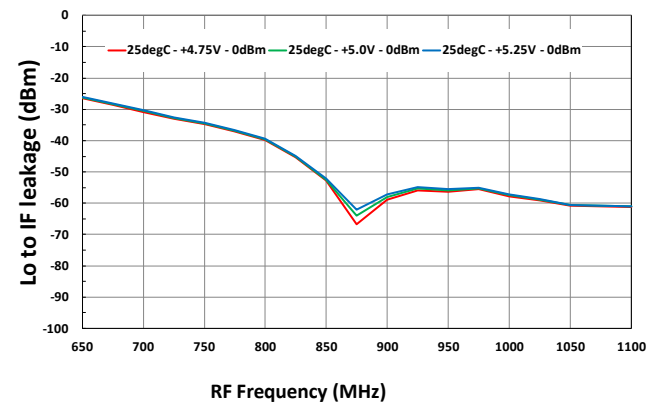

TOCs [IF = 200MHz, HIGH SIDE INJECTION] RF to IF leakage, OIP3, HD2 (5)

RF to IF leakage vs. T_{CASE}

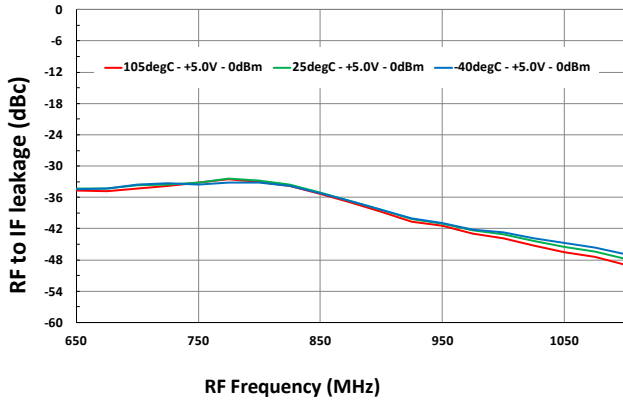

RF to IF leakage vs. Lo Level

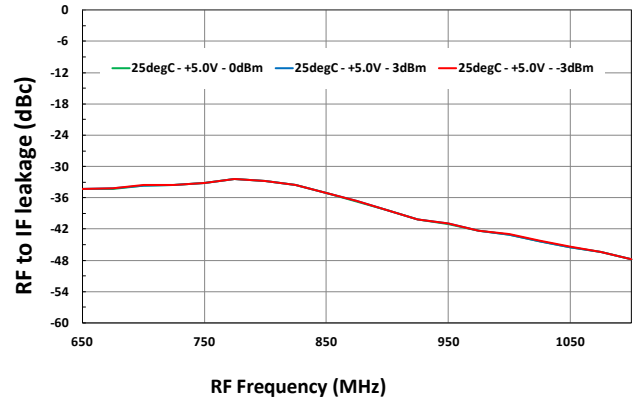

RF to IF leakage vs. Vcc

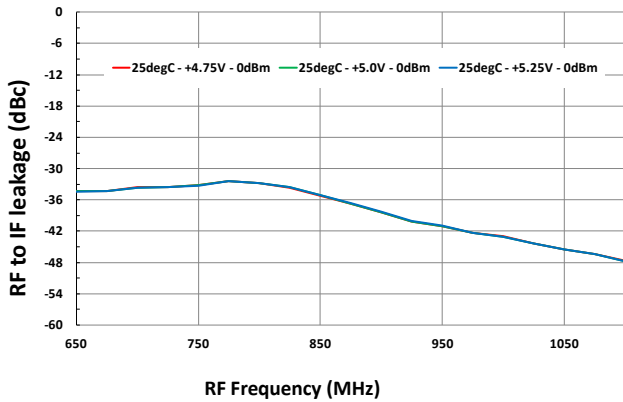

OIP3 vs. Input power

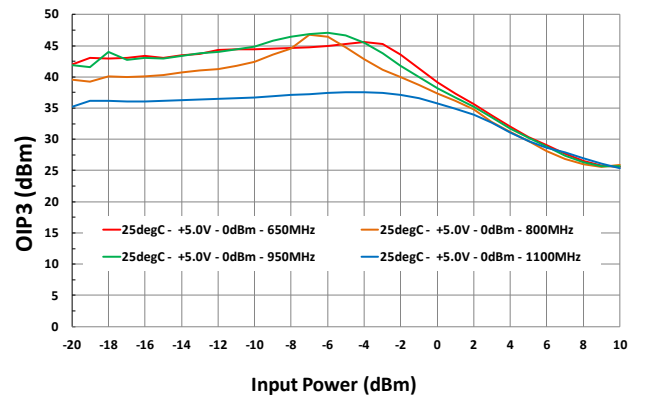

HD2 vs. Input power

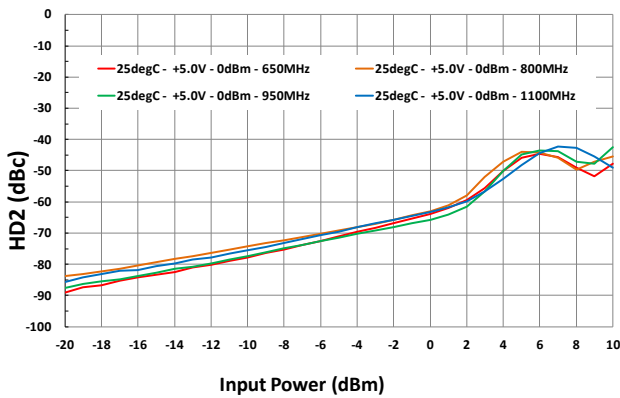

OIP3 vs. Delta Frequency of two tones

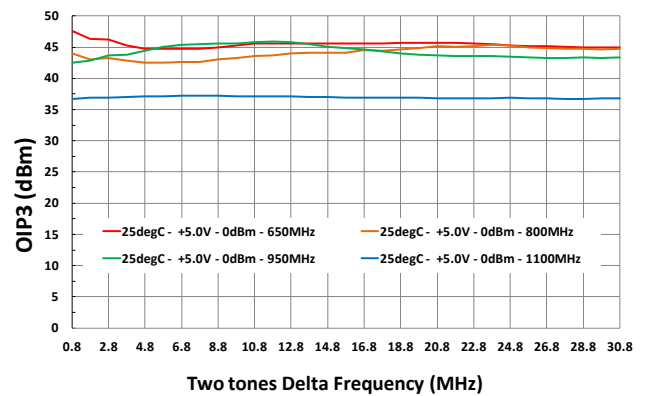

TOCs [IF = 200MHz, LOW SIDE INJECTION] Gain, OIP3 (6)

Gain vs. T_{CASE}

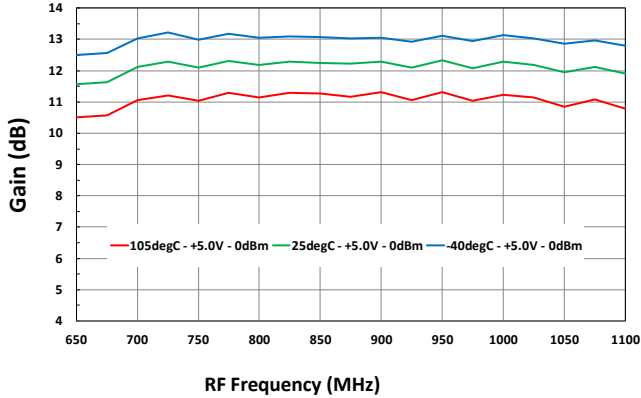

Gain vs. Lo Level

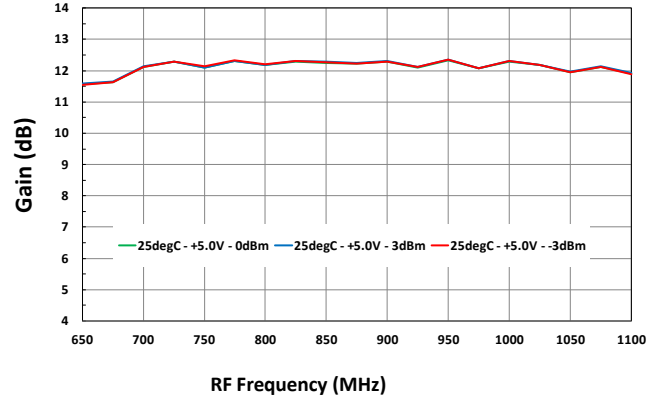

Gain vs. Vcc

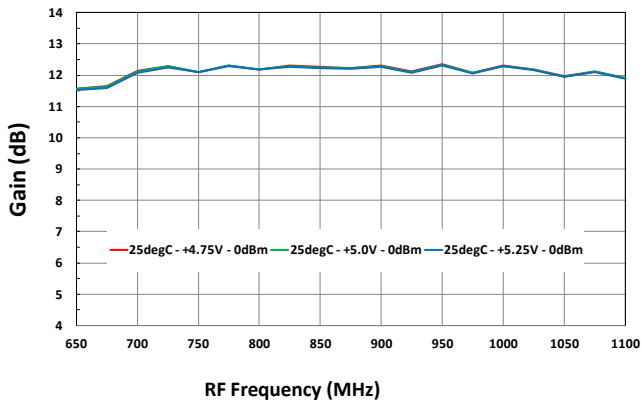

Output IP3 vs. T_{CASE}

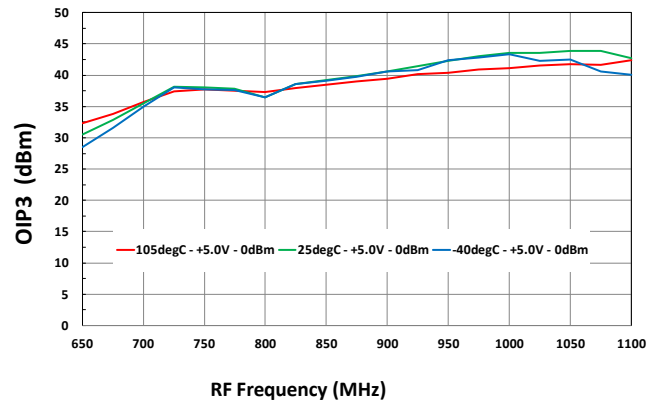

Output IP3 vs. Lo Level

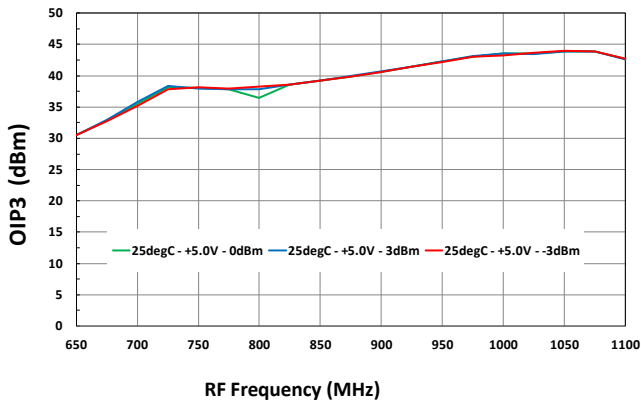

Output IP3 vs. Vcc

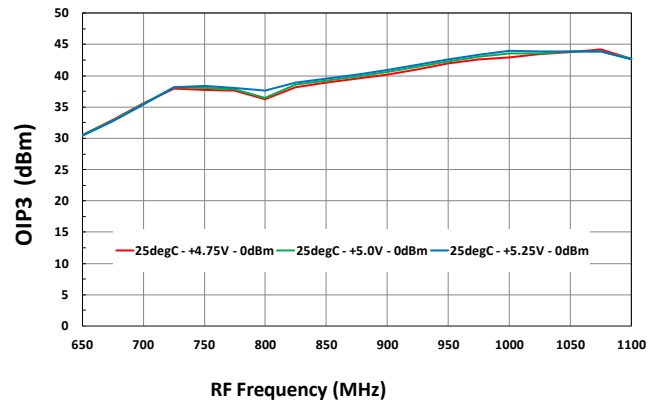

TOCs [IF = 200MHz, LOW SIDE INJECTION] P1dB_o, 2x2 (7)

P1dB_o vs. T_{CASE}

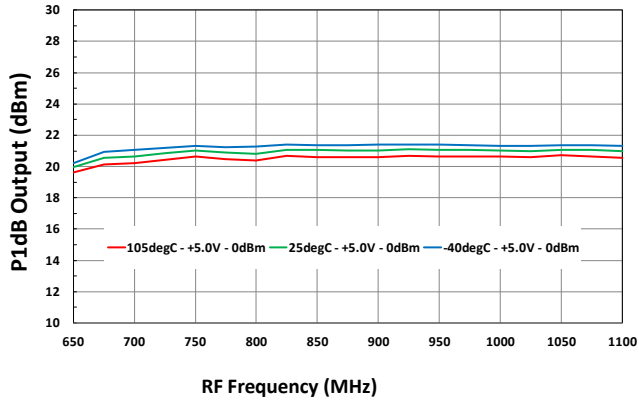

P1dB_o vs. Lo Level

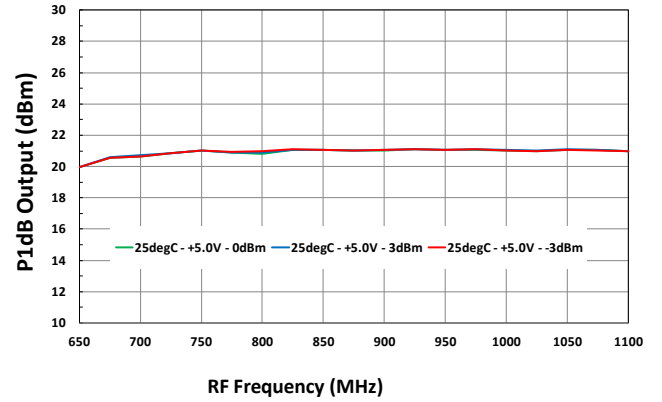

P1dB_o vs. V_{CC}

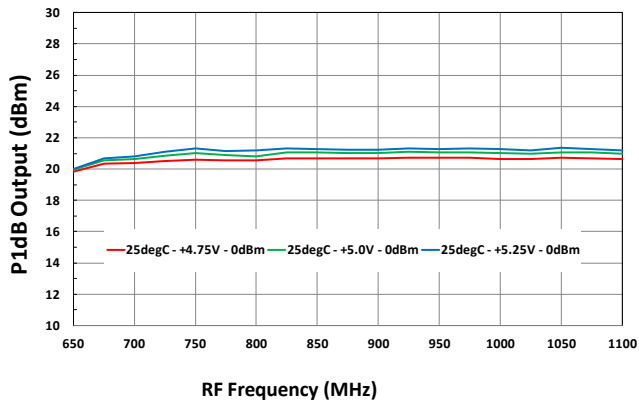

2x2 Rejection vs. T_{CASE}

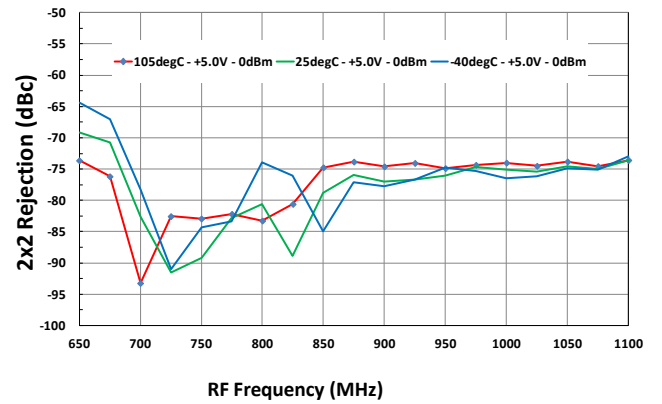

2x2 Rejection vs. Lo Level

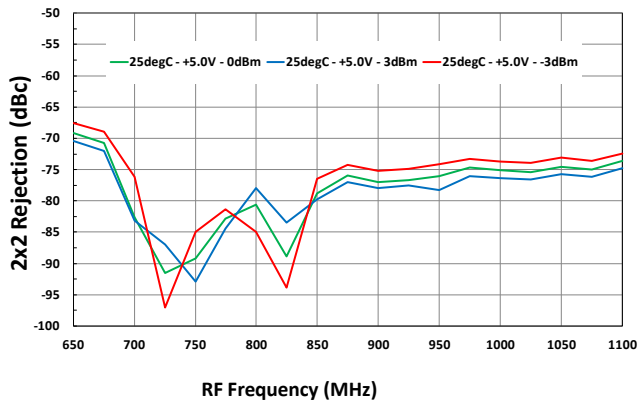

2x2 Rejection vs. V_{CC}

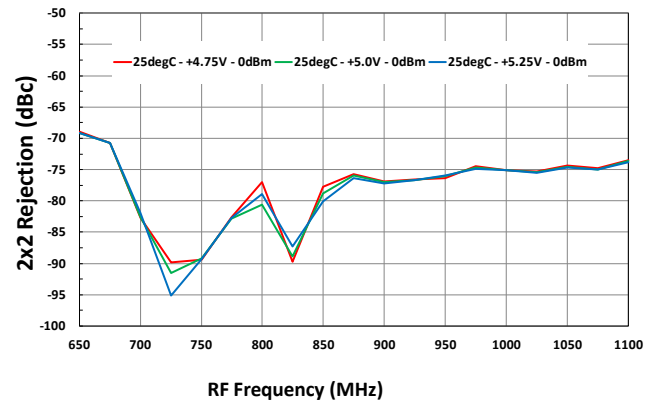

TOCs [IF = 200MHz, LOW SIDE INJECTION] 3x3, H2 Rejection (8)

3x3 Rejection vs. T_{CASE}

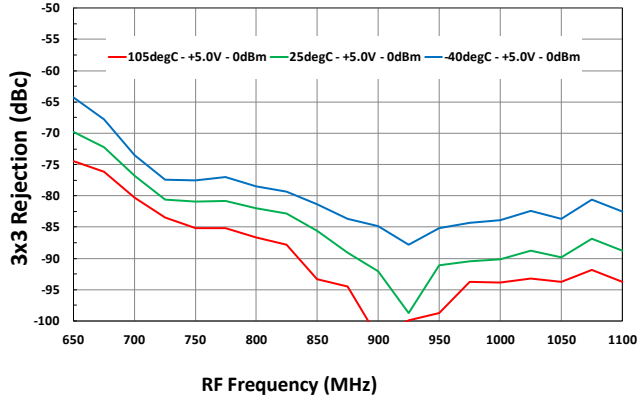

3x3 Rejection vs. Lo Level

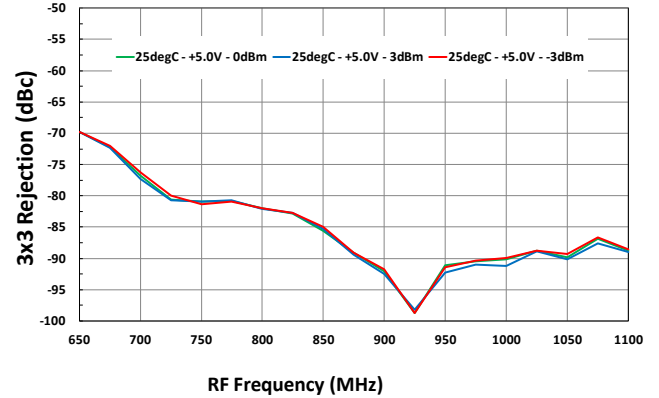

3x3 Rejection vs. V_{CC}

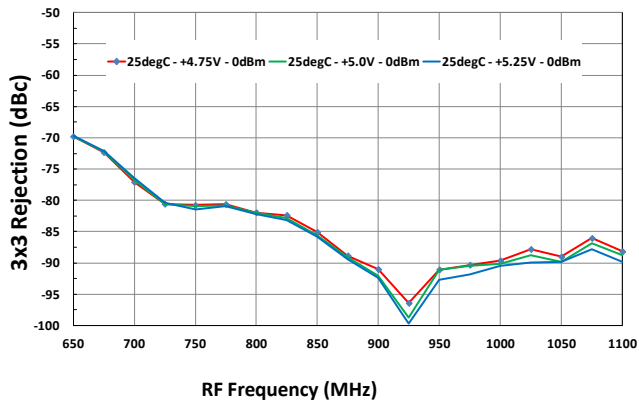

H2 Rejection vs. T_{CASE}

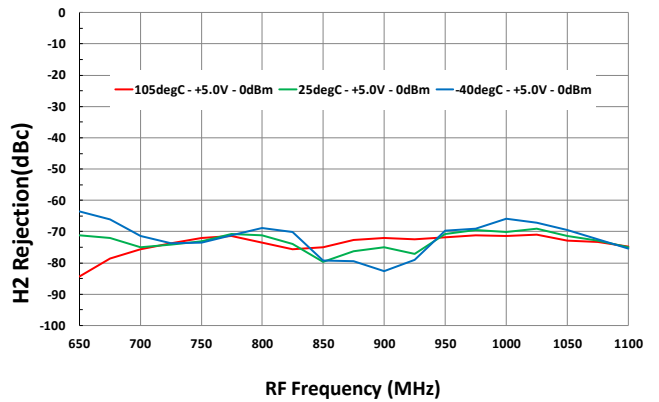

H2 Rejection vs. Lo Level

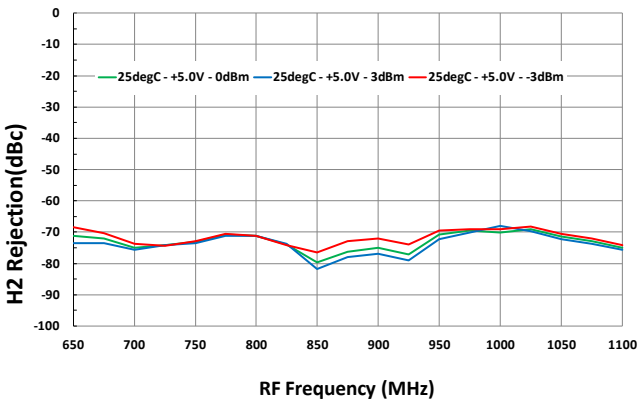

H2 Rejection vs. V_{CC}

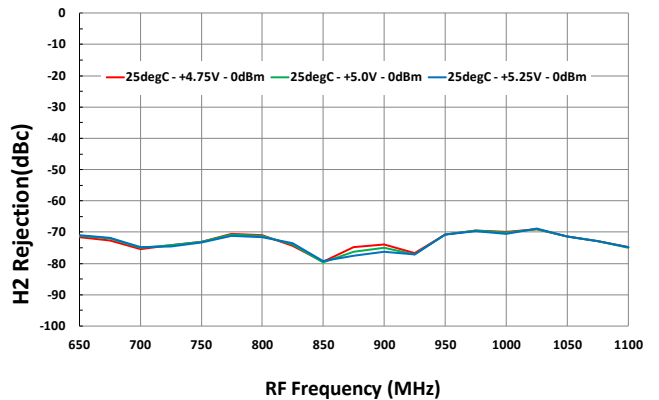

TOCs [IF = 200MHz, LOW SIDE INJECTION] Icc, Lo to IF Leakage (9)

ICC vs. T_{CASE}

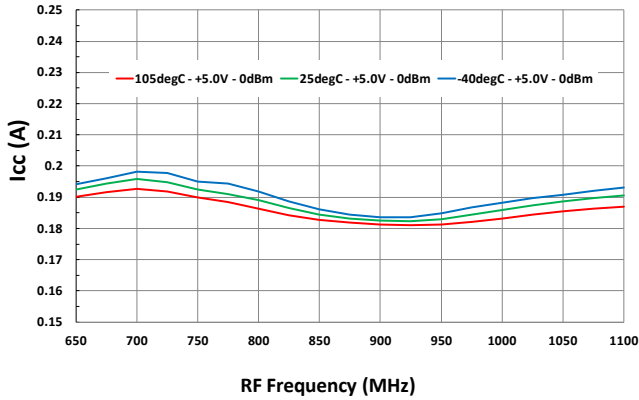

Icc vs. Lo Level

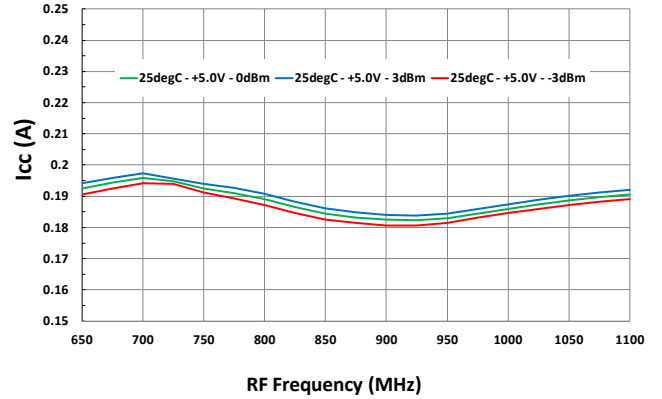

ICC vs. Vcc

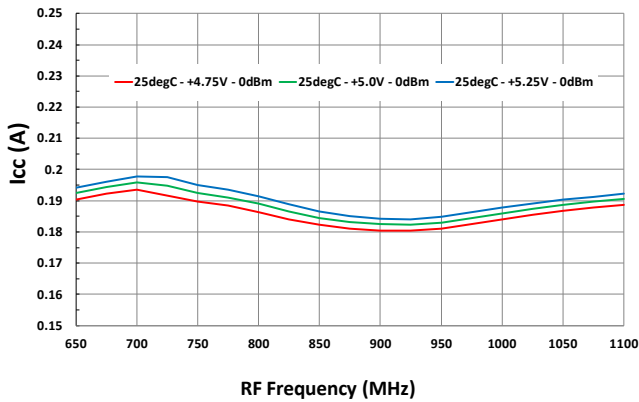

Lo to IF leakage vs. T_{CASE}

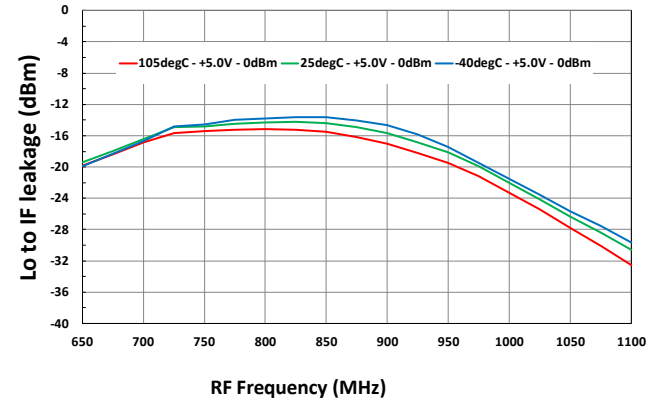

Lo to IF leakage vs. Lo Level

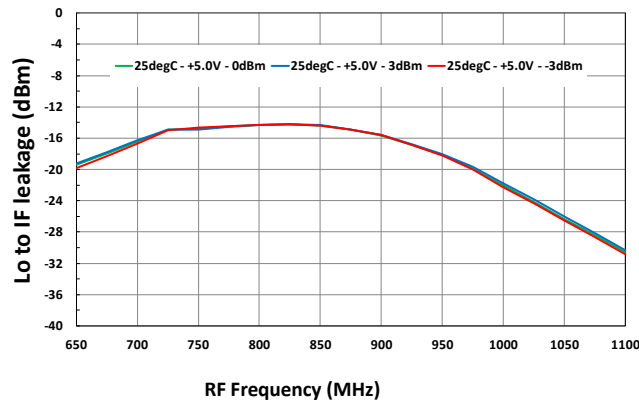

Lo to IF leakage vs. Vcc

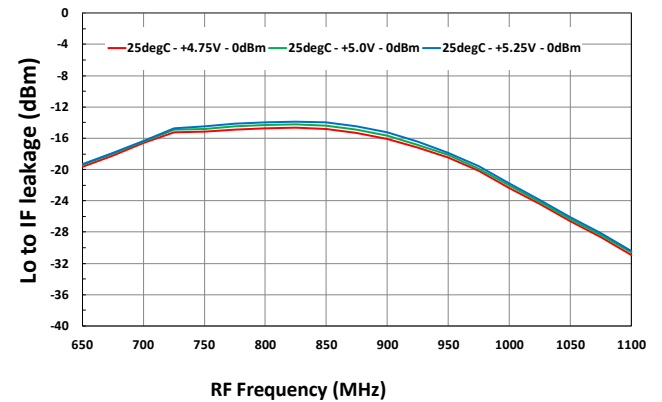

TOCs [IF = 200MHz, Low Side Injection] RF to IF leakage, OIP3, H2 (10)

RF to IF leakage vs. T_{CASE}

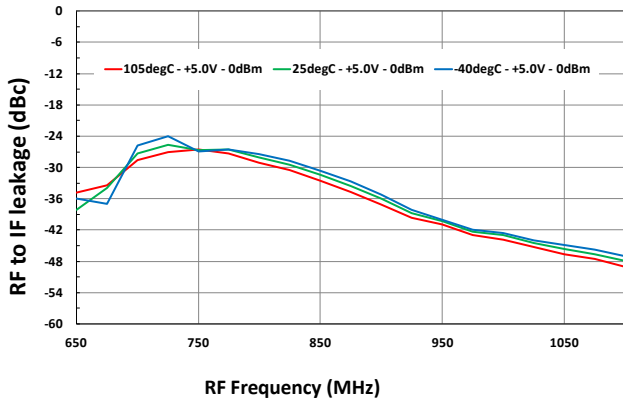

RF to IF leakage vs. Lo Level

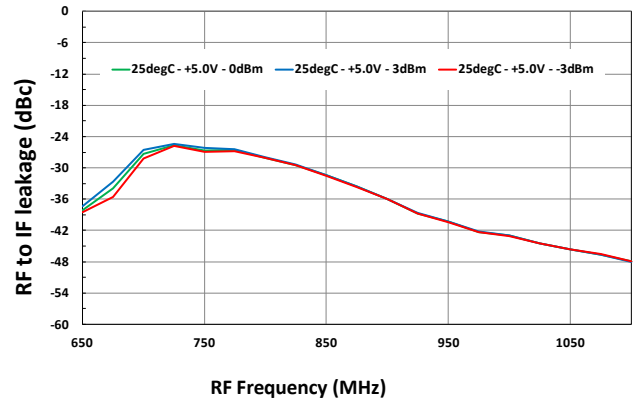

RF to IF leakage vs. Vcc

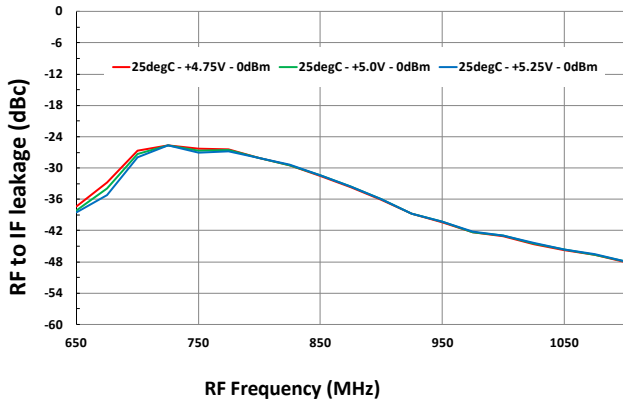

OIP3 vs. Input power

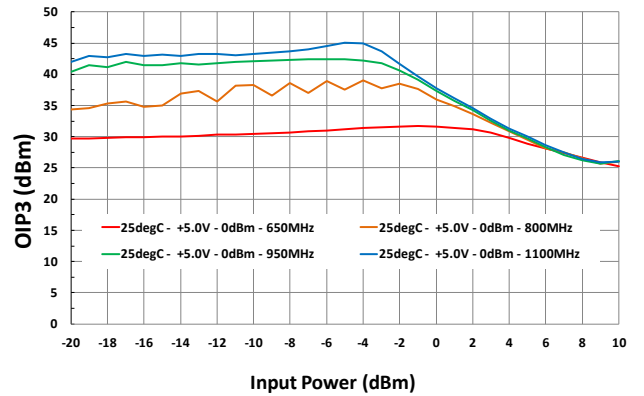

HD2 vs. Input power

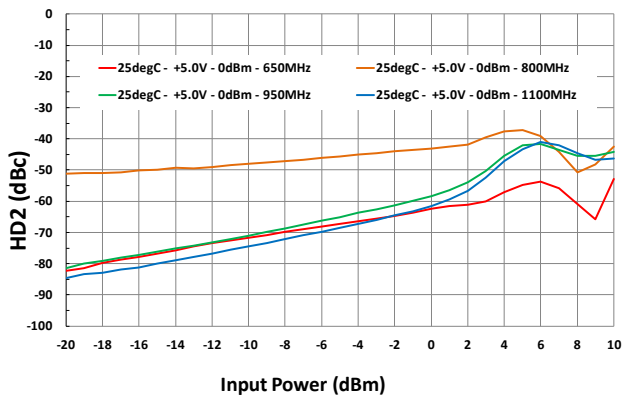

OIP3 vs. Delta Frequency of two tones

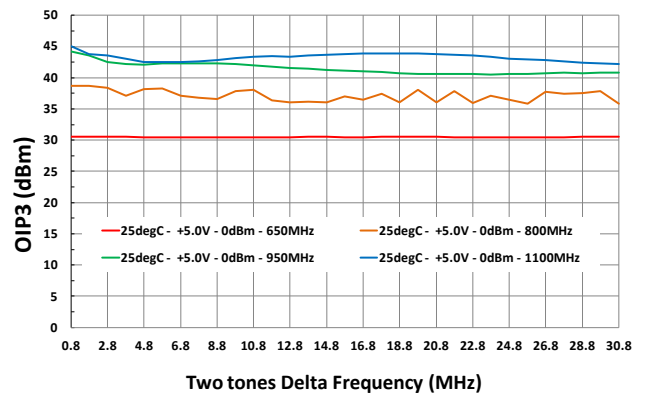

TOCs NF, Settling Time, Return Loss (11)

Noise Figure vs. T_{CASE}

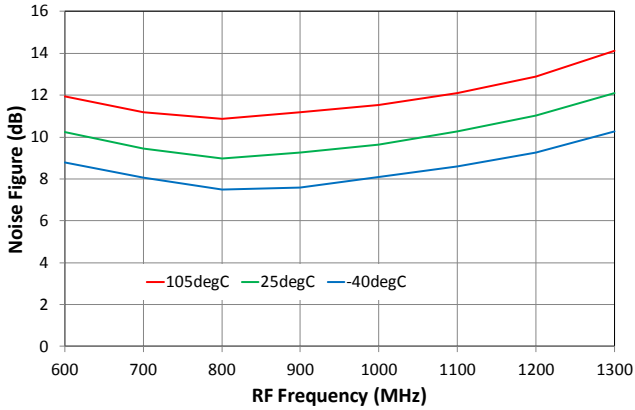

Noise Figure with Blocker (RF: 950MHz, Blocker: 850MHz)

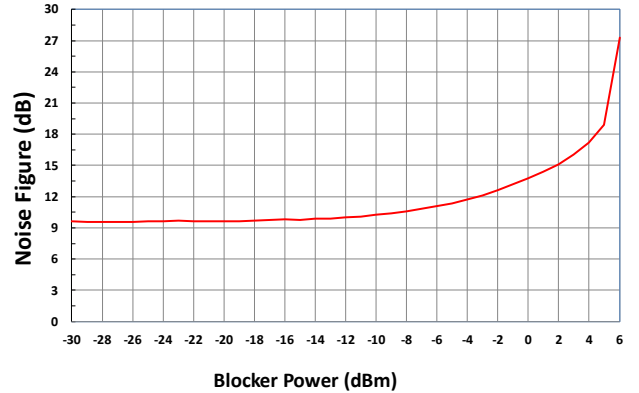

Turn on Settling

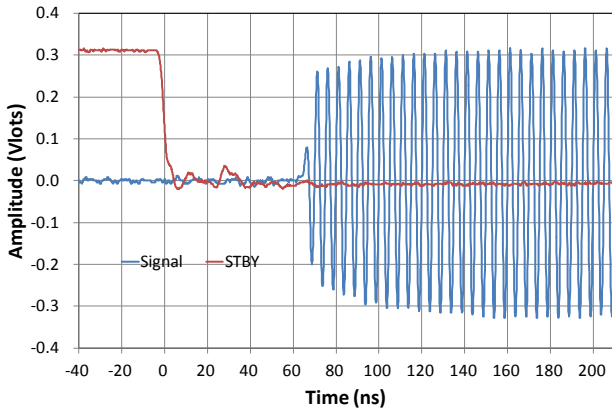

Turn off Settling

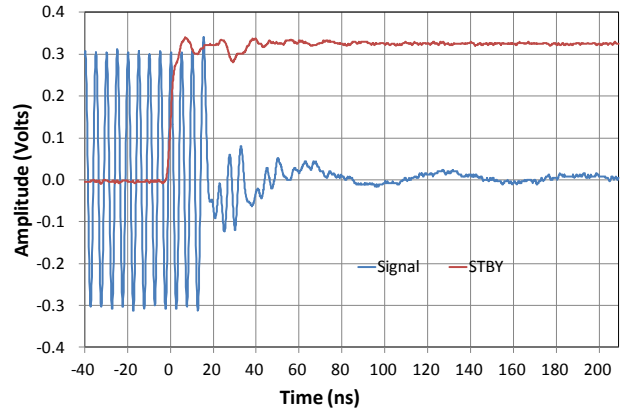

Lo port Return Loss

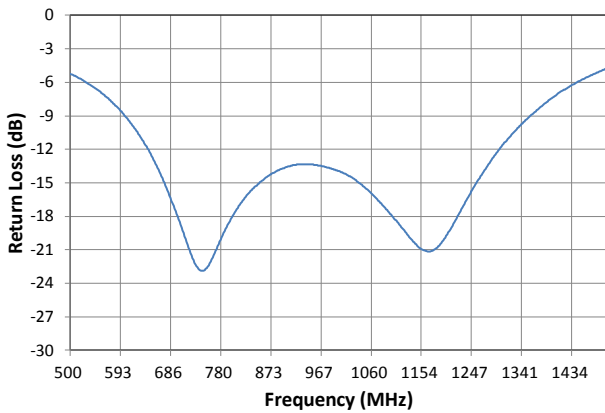

RF port Return Loss

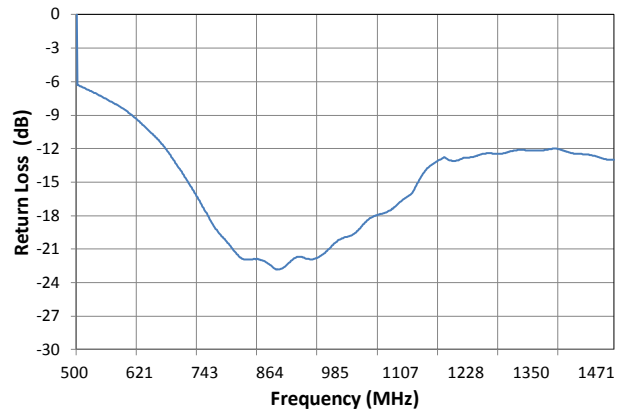

TOCs Return Loss (12)

IF port Return Loss

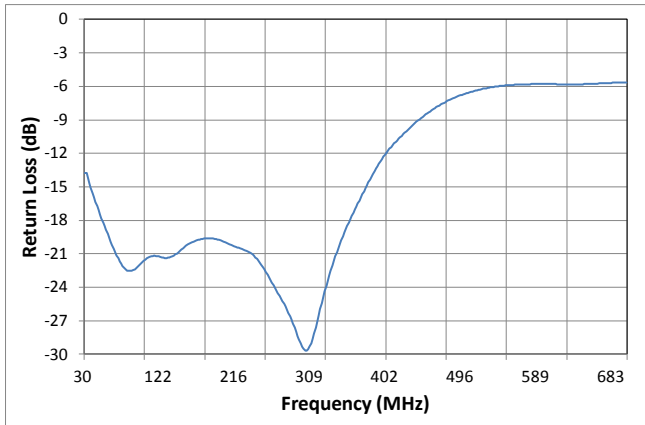

PACKAGE DRAWING (NBG20)

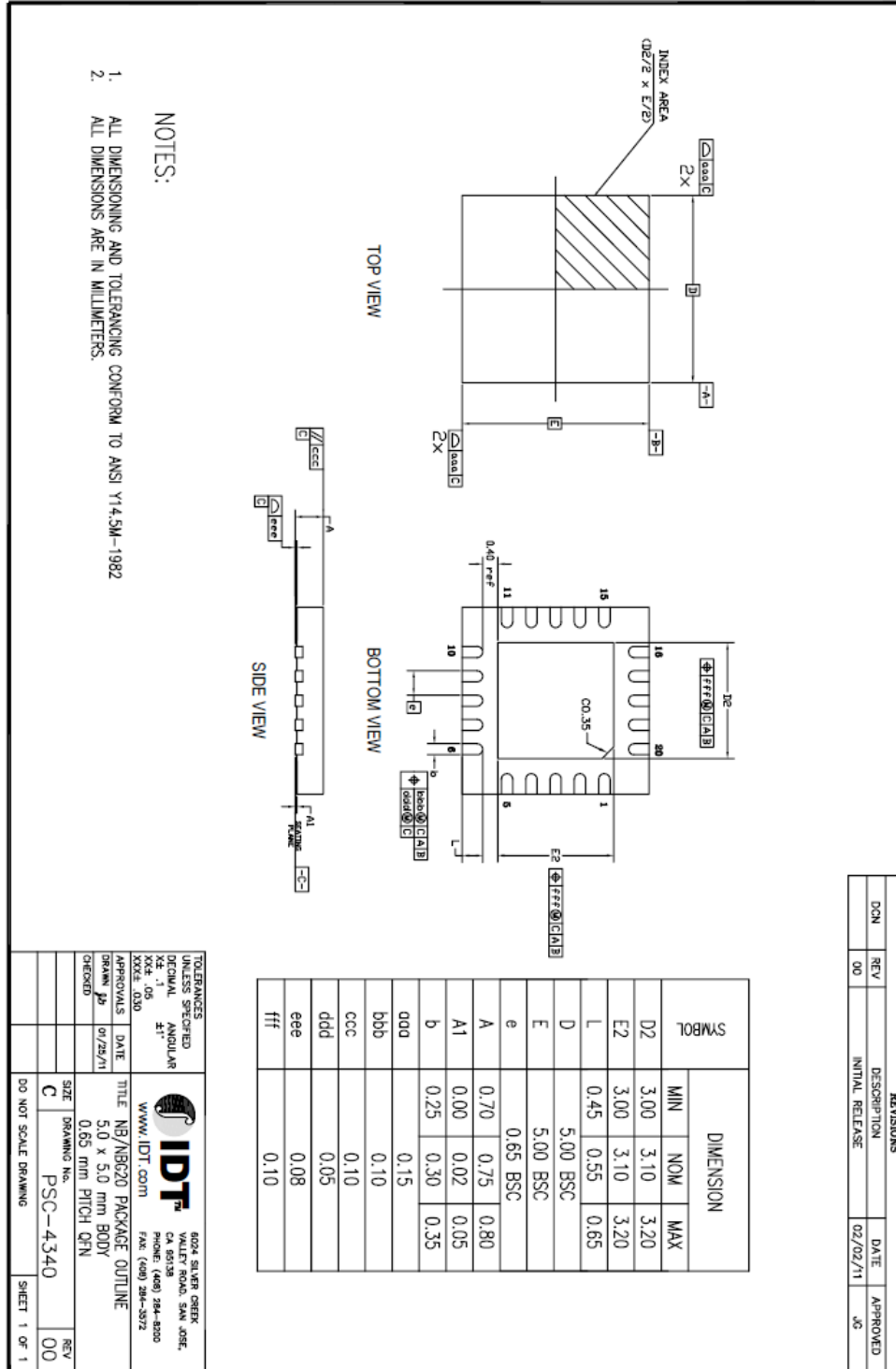

PIN DIAGRAM

BLACK TEXT is recommended external connection
RED TEXT denotes internal function or connection

TOP View
(looking through the top of the package)

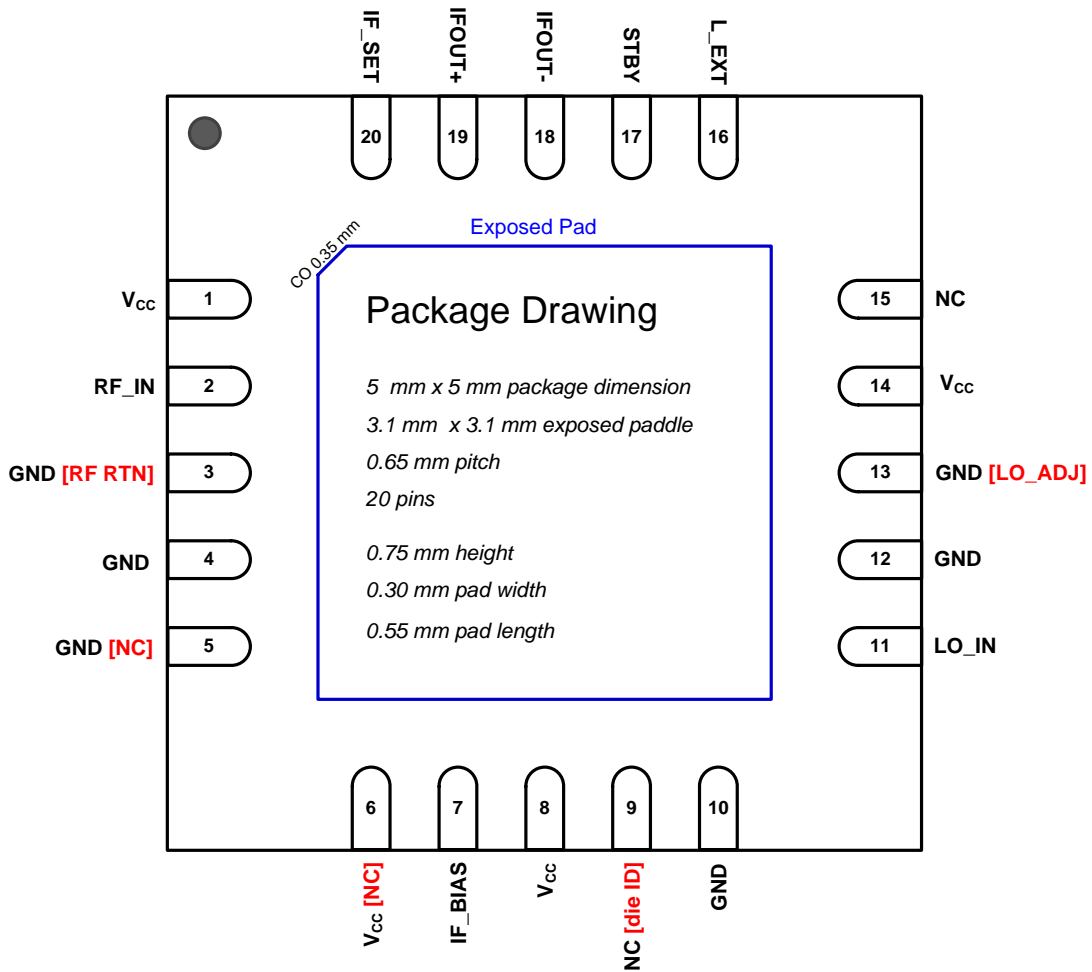

PIN DESCRIPTIONS

Pin	Name	Function
1	VCC	Power Supply. Bypass to GND with capacitors shown in the Typical Application Circuit as close as possible to pin.
2	RF_IN	RF Input. Internally matched to 50Ω. Do not apply DC to this pin.
3	GND [RF_RTN]	RF input Balun return. Ground this pin
4	GND	Internally bonded to GND
5	GND [NC]	No Connection. Not internally connected. OK to connect to VCC. OK to connect to GND.
6	VCC [NC]	No Connection. Not internally connected. OK to connect to VCC. OK to connect to GND.
7	IF_BIAS	Connect the specified resistor from this pin to ground to optimize linearity.
8	VCC	Power Supply. Bypass to GND with capacitors shown in the Typical Application Circuit as close as possible to pin.
9	NC [die ID]	This pin serves as the die ID. Leave it unconnected
10	GND	Internally bonded to GND
11	LO_IN	Local Oscillator Input. This input is internally matched to 50Ω. This pin requires an input DC-blocking capacitor
12	GND	Internally bonded to GND
13	GND [LO_ADJ]	Ground this pin for best linearity performance. A resistor from this pin to GND can be used to reduce DC power consumption while slightly degrading linearity performance.
14	VCC	Power Supply. Bypass to GND with capacitors shown in the Typical Application Circuit as close as possible to pin.
15	NC	No Connection. Not internally connected. OK to connect to VCC. OK to connect to GND.
16	L_EXT	Connect an external inductor to GND to optimize LO-IF leakage performance.
17	STBY	Ground for normal operation. Pull high to disable
18	IF_OUT-	Mixer Differential IF Output. Connect pullup inductor from this pin to VCC (see the Typical Application Circuit).
19	IF_OUT+	Mixer Differential IF Output. Connect pullup inductor from this pin to VCC (see the Typical Application Circuit).
20	IF_SET	Connect the specified resistor from this pin to ground to set the correct Icc for the IF amplifier.
	— EP	Exposed Pad. Internally connected to GND. Connect to Ground with multiple vias for good thermal relief

POWER SUPPLIES

All supply pins should be bypassed with external capacitors to minimize noise and fast transients. Supply noise can degrade noise figure and fast transients can trigger ESD clamps and cause them to fail. Supply voltage change or transients should have a slew rate smaller than $1V/20\mu S$. In addition, all control pins should remain at 0V (+/-0.3V) while the supply voltage ramps or while it returns to zero.

EVKIT PICTURE/LAYOUT/OPERATION

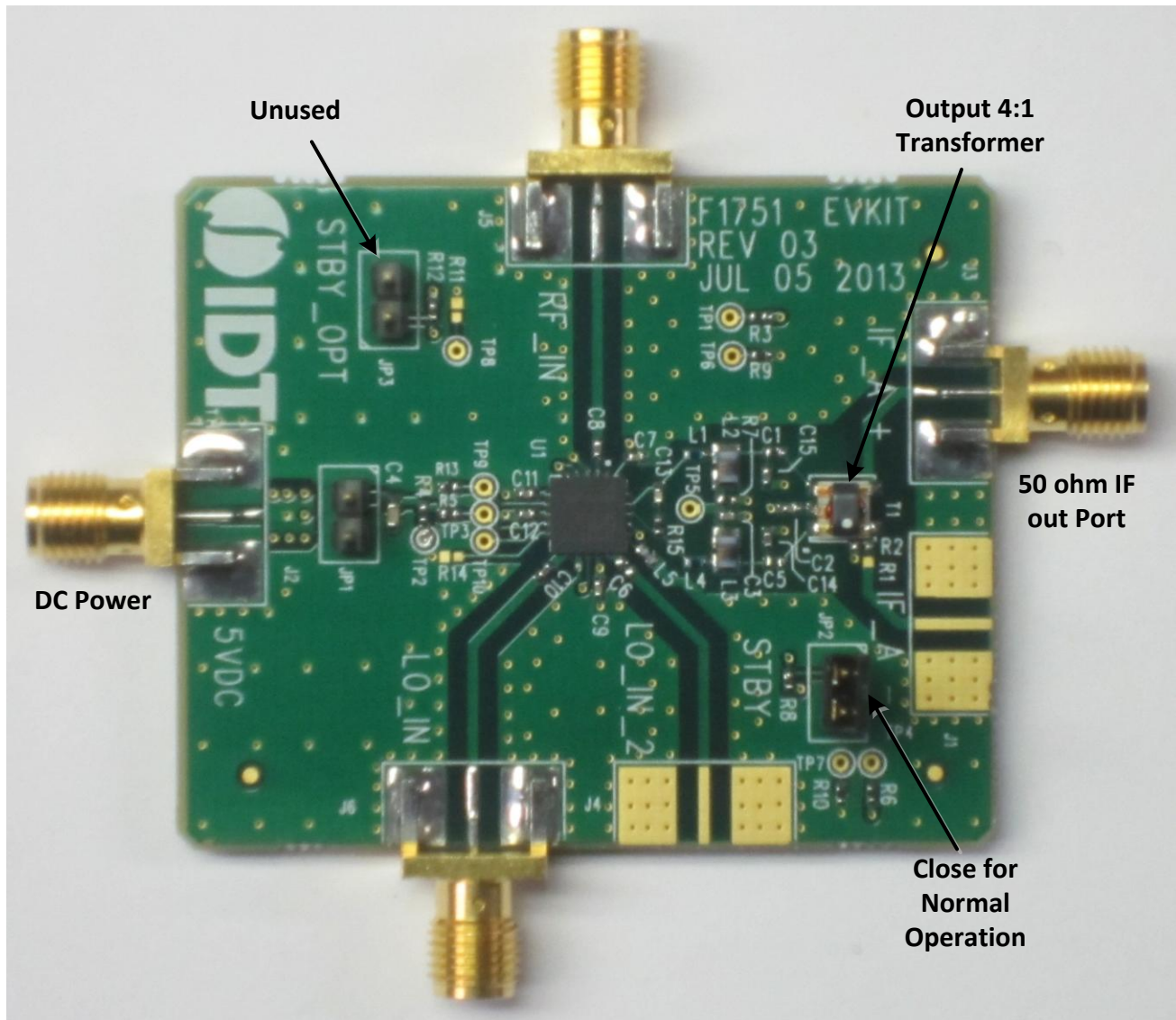

EVKIT BOM

F1701
11/26/2013

Item #	Value	Size/Rev	Desc	Mfr. Part #	Mfr.	Supplier Part #	Supplier	Part Reference	Qty
1	10nF	0402	CAP CER 10000PF 16V 10% X7R 0402	GRM155R71C103KA01D	MURATA	490-1313-1-ND	Digikey	C2,3,7,9,12	5
2	10uF	0603	CAP CER 10UF 6.3V X5R 0603	GRM188R60J106ME47D	MURATA	490-3896-1-ND	Digikey	C4	1
3	0.5pF	0402	CAP CER 0.5PF 50V NP0 0402	GJM1555C1HR50BB01D	MURATA	490-6077-1-ND	Digikey	C13	1
4	3pF	0402	CAP CER 3PF 50V C0G 0402	GRM1555C1H3R0CZ01D	MURATA	490-3205-1-ND	Digikey	C14,15	2
5	39pF	0402	CAP CER 39PF 50V 5% C0G 0402	GRM1555C1H390JZ010	MURATA	490-1286-1-ND	Digikey	C8,10	2
6	0	0402	RES 0.0 OHM 1/10W 0402 SMD	ERJ-2GE0R00X	Panasonic	P0.0JCT-ND	Digikey	R2,3,4,5,6,7,10,11,14,C1,C5	11
7	100	0402	RES 100 OHM 1/10W 1% 0402 SMD	ERJ-2RKF1000X	Panasonic	P100LCT-ND	Digikey	R15	1
8	806	0402	RES 806 OHM 1/10W 1% 0402 SMD	ERJ-2RKF8060X	Panasonic	P806LCT-ND	Digikey	R9	1
9	6.19K	0402	RES 6.19K OHM 1/10W 1% 0402 SMD	ERJ-2RKF6191X	Panasonic	P6.19KLCT-ND	Digikey	R13	1
10	47K	0402	RES 47.0K OHM 1/16W 1% 0402 SMD	RC0402FR-0747KL	Yageo	311-47.0KLRCT-ND	Digikey	R8	1
11	36nH	0402	0402 Inductor 36nH LQW series	LQW15AN36NJ00D	MURATA	LQW15AN36NJ00D-ND	Digikey	L1,4	2
12	820nH	0805	0805CS (2012) Ceramic Chip Inductor	0805CS-821XJLB	COILCRAFT	0805CS-821XJLB	COILCRAFT	L2,3	2
13	10nH	402	0402CS Ceramic Chip Inductor	0402CS-10NXJLU	COILCRAFT	0402CS-10NXJLU	COILCRAFT	L5	1
14	Header_2Pin	TH_2	CONN HEADER VERT SGL 2POS GOLD	961102-6404-AR	3M	3M9447-ND	Digikey	JP1,2,3	3
15	SMA_END_LAUNCH	.062	CONN SMA JACK END LAUNCH PCB (Big)	142-0701-851	Emerson Johnson	530-142-0701-851	Mouser	J5,6	2
16	SMA_END_LAUNCH	.062	CONN SMA JACK END LAUNCH PCB (Small)	142-0711-821	Emerson Johnson	530-142-0711-821	Mouser	J2,3	2
17	4:1 Balun	SM-22	4:1 Center Tap Balun 50 OHM 3 TO 800Mhz	TC4-6TG2+	Mini Circuits	TC4-6TG2+	Mini Circuits	T1	1
18	F1701	QFN-24	IF MIXER NBG24	F1701	IDT	F1701-014		U1	1
19	PCB	03	Printed Circuit Board	F1751 EV Kit Rev 03					1
20	BOM	01	Bill Of Material						
21	DNP	402						R1,12,C6,11,JP3	
Total									41

TOP MARKINGS

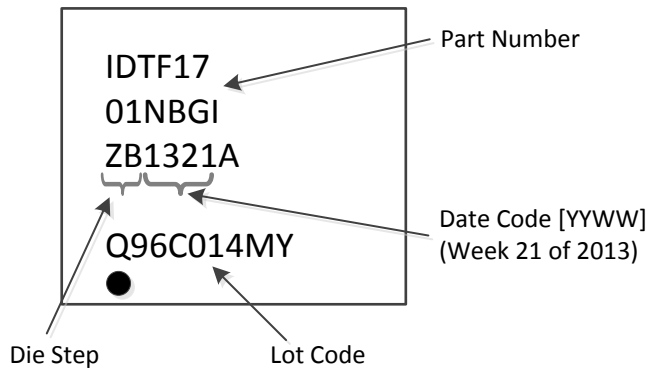

IMPORTANT NOTICE AND DISCLAIMER

RENESAS ELECTRONICS CORPORATION AND ITS SUBSIDIARIES (“RENESAS”) PROVIDES TECHNICAL SPECIFICATIONS AND RELIABILITY DATA (INCLUDING DATASHEETS), DESIGN RESOURCES (INCLUDING REFERENCE DESIGNS), APPLICATION OR OTHER DESIGN ADVICE, WEB TOOLS, SAFETY INFORMATION, AND OTHER RESOURCES “AS IS” AND WITH ALL FAULTS, AND DISCLAIMS ALL WARRANTIES, EXPRESS OR IMPLIED, INCLUDING, WITHOUT LIMITATION, ANY IMPLIED WARRANTIES OF MERCHANTABILITY, FITNESS FOR A PARTICULAR PURPOSE, OR NON-INFRINGEMENT OF THIRD PARTY INTELLECTUAL PROPERTY RIGHTS.

These resources are intended for developers skilled in the art designing with Renesas products. You are solely responsible for (1) selecting the appropriate products for your application, (2) designing, validating, and testing your application, and (3) ensuring your application meets applicable standards, and any other safety, security, or other requirements. These resources are subject to change without notice. Renesas grants you permission to use these resources only for development of an application that uses Renesas products. Other reproduction or use of these resources is strictly prohibited. No license is granted to any other Renesas intellectual property or to any third party intellectual property. Renesas disclaims responsibility for, and you will fully indemnify Renesas and its representatives against, any claims, damages, costs, losses, or liabilities arising out of your use of these resources. Renesas' products are provided only subject to Renesas' Terms and Conditions of Sale or other applicable terms agreed to in writing. No use of any Renesas resources expands or otherwise alters any applicable warranties or warranty disclaimers for these products.

(Rev.1.0 Mar 2020)

Corporate Headquarters

TOYOSU FORESIA, 3-2-24 Toyosu,
Koto-ku, Tokyo 135-0061, Japan
www.renesas.com

Contact Information

For further information on a product, technology, the most up-to-date version of a document, or your nearest sales office, please visit:
www.renesas.com/contact/

Trademarks

Renesas and the Renesas logo are trademarks of Renesas Electronics Corporation. All trademarks and registered trademarks are the property of their respective owners.

X-ON Electronics

Largest Supplier of Electrical and Electronic Components

Click to view similar products for [RF Mixer](#) category:

Click to view products by [Renesas](#) manufacturer:

Other Similar products are found below :

[HMC337-SX](#) [HMC404-SX](#) [mamx-009646-23dbml](#) [HMC339-SX](#) [HMC8192-SX](#) [MIQ24MS-2](#) [HMC220BMS8GETR](#) [M85C](#) [HMC554A-SX](#)
[HMC8192LG](#) [HMC521A-SX](#) [HMC521ACHIPS](#) [CMD258C4](#) [LT5511EFE](#) [MAMX-011023-SMB](#) [HMC399MS8TR](#) [HMC333TR](#)
[HMC214MS8TR](#) [HMC175MS8TR](#) [MAMXSS0012TR-3000](#) [109728-HMC129LC4](#) [CSM1-13](#) [SA612AD/01.112](#) [HMC785LP4ETR](#)
[LT5579IUH#PBF](#) [HMC773ALC3BTR](#) [HMC558ALC3B](#) [HMC329ALC3B](#) [MY63H](#) [AD8343ARUZ-REEL7](#) [AD608AR](#) [AD608ARZ](#)
[AD831APZ](#) [AD831APZ-REEL7](#) [AD8342ACPZ-REEL7](#) [AD8343ARUZ](#) [AD8344ACPZ-REEL7](#) [ADL5350ACPZ-R7](#) [ADL5363ACPZ-R7](#)
[ADL5365ACPZ-R7](#) [ADL5801ACPZ-R7](#) [ADL5802ACPZ-R7](#) [HMC1056LP4BE](#) [HMC1057-SX](#) [HMC1063LP3E](#) [HMC1093-SX](#) [HMC1106-](#)
[SX](#) [HMC129](#) [HMC143](#) [HMC400MS8ETR](#)