

HA179L00 Series

3-terminal Negative Fixed Voltage Regulators

REJ03D0690-0200

Rev.2.00

Oct 26, 2006

Description

The HA179L00 series are three-terminal fixed output voltage regulators. These are small outline packages which are useful ICs. For application example, as Zener diodes, easy stabilized power sources.

Features

- Some kinds output voltage series
- Superior ripple rejection ratio for audio frequency
- Large maximum power dissipation: 800 mW
- Over current and over temperature protection

Ordering Information

Application	Output Voltage	Type No.	Package Code (Package Name)
Industrial use	-5	HA179L05P	PRSS0003DC-A (TO-92MODV)
	-6	HA179L06P	
	-8	HA179L08P	
	-9	HA179L09P	
	-10	HA179L10P	
	-12	HA179L12P	
	-15	HA179L15P	
Commercial use	-5	HA179L05	PRSS0003DC-A (TO-92MODV)
	-6	HA179L06	
	-8	HA179L08	
	-9	HA179L09	
	-10	HA179L10	
	-12	HA179L12	
	-15	HA179L15	
Commercial use	-5	HA179L05U	PLZZ0004CA-A (UPAK)
	-6	HA179L06U	
	-8	HA179L08U	
	-9	HA179L09U	
	-10	HA179L10U	
	-12	HA179L12U	
	-15	HA179L15U	

Output Voltage Accuracy Grade

Use	Standard ($\pm 4\%$)
Industrial Use	HA179L00P
Commercial Use	HA179L00
	HA179L00U

Pin Arrangement

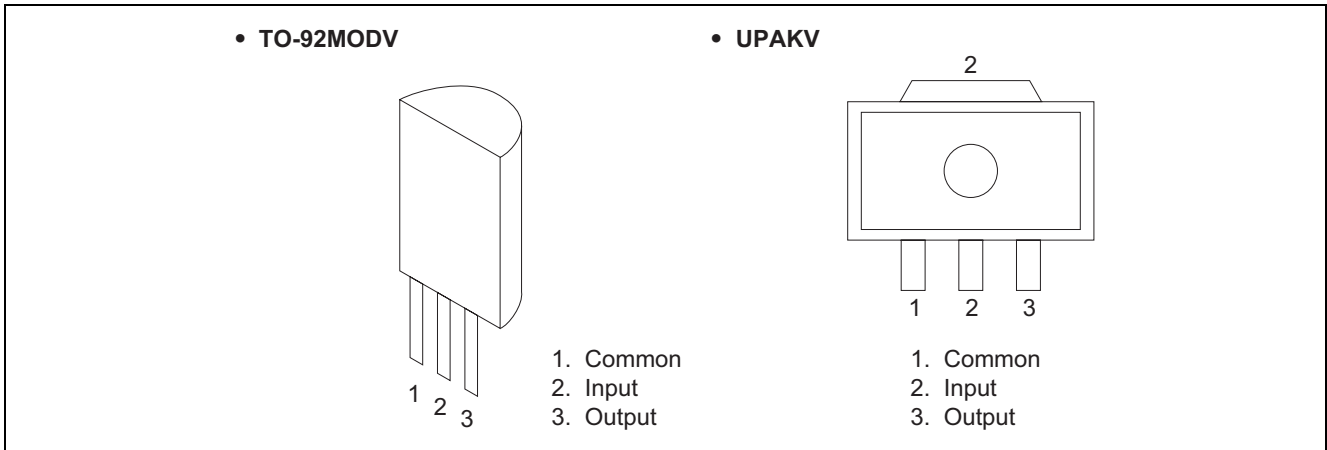

Block Diagram

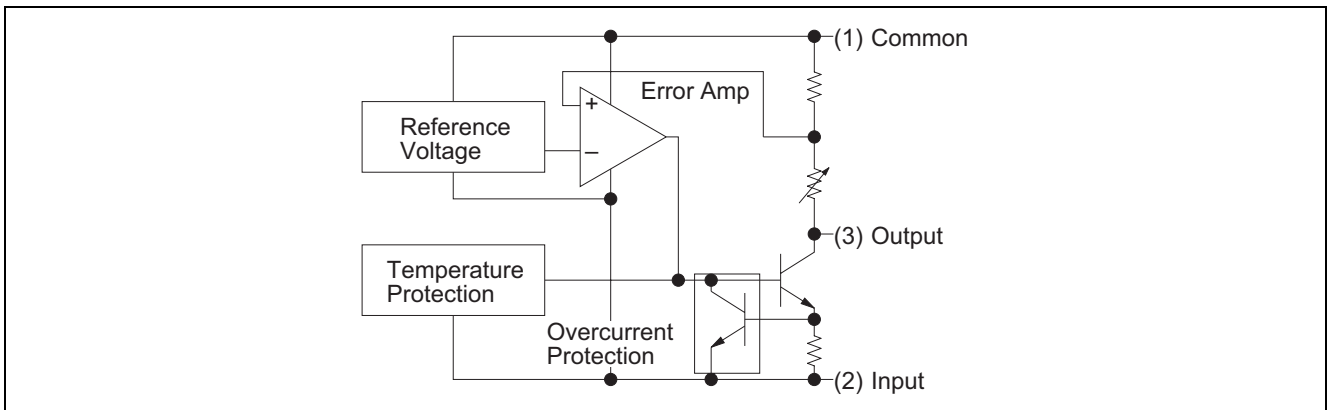

Standard Circuit

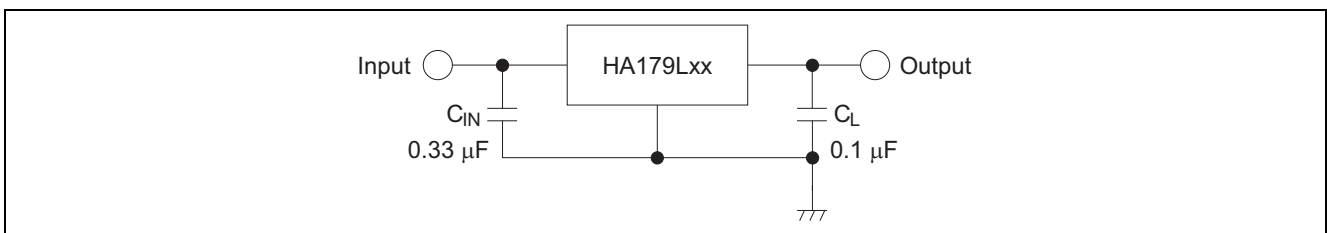

UPAKV Product (HA179L00U) Mark Patterns

The mark patterns shown below are used on UPAKV products, as the package is small. Note that the product code and mark pattern are different.

The pattern is laser-printed.

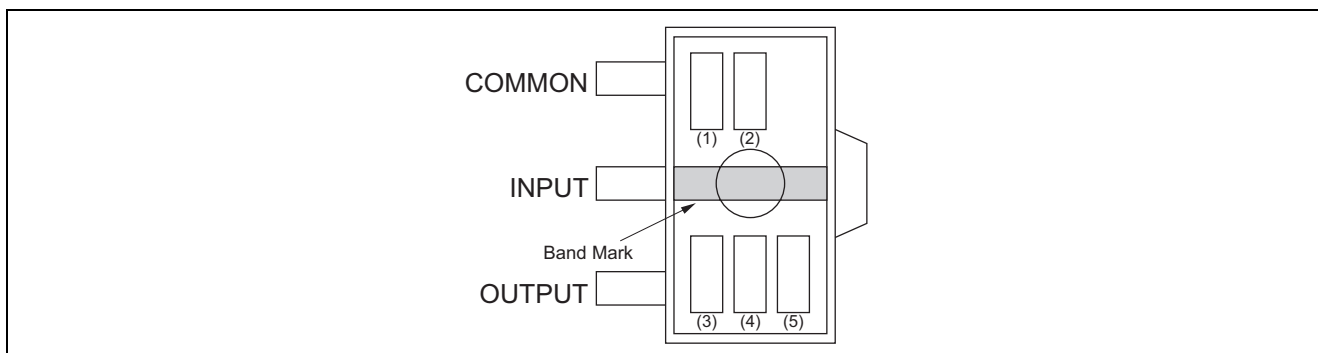

- Notes: 1. Boxes (1) to (5) in the figures show the position of the letters or numerals, and are not actually marked on the package.
 2. (1) and (2) show the product-specific mark pattern. (see table 1)

Table 1

Output Voltage (V)	Type No.	Mark Pattern (2 digit)
-5	HA179L05U	9B
-6	HA179L06U	9D
-8	HA179L08U	9E
-9	HA179L09U	9F
-10	HA179L10U	9G
-12	HA179L12U	9H
-15	HA179L15U	9J

3. (3) shows the production year code (the last digit of the year).
 4. (4) shows the production month code (see table 2).

Table 2

Production Month	1	2	3	4	5	6	7	8	9	10	11	12
Marked Code	A	B	C	D	E	F	G	H	J	K	L	M

5. (5) shows the production week code.

Absolute Maximum Ratings

(Ta = 25°C)

Item	Symbol	Rating		Unit
		HA179L00P, HA179L00 Series	HA179L00U Series	
Input voltage	V _{IN}	-35	-35	V
Max power dissipation	P _T * ¹	800	800 * ²	mW
Operating ambient temperature	T _{opr}	-40 to +85	-40 to +85	°C
Storage temperature	T _{stg}	-55 to +150	-55 to +150	°C

- Notes: 1. Ta ≤ 25°C, If Ta > 25°C, derate by 6.4 mW/°C
 2. 15 mm × 25 mm × 0.7 mm glass epoxy board, Ta ≤ 25°C

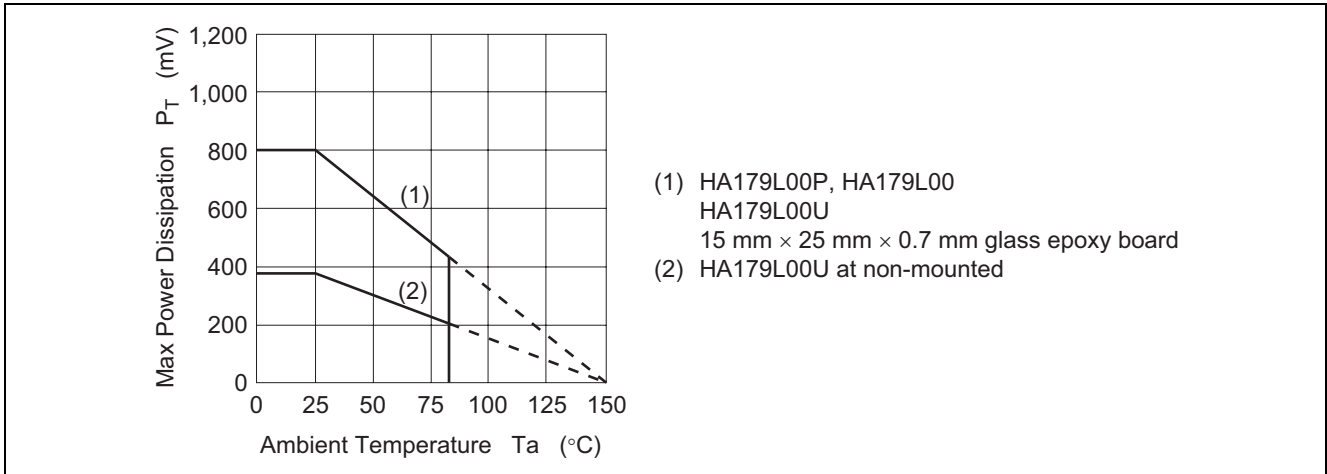

- (1) HA179L00P, HA179L00
 HA179L00U
 15 mm × 25 mm × 0.7 mm glass epoxy board
 (2) HA179L00U at non-mounted

Electrical Characteristics

HA179L05P, HA179L05, HA179L05U

($V_{IN} = -10\text{ V}$, $I_{OUT} = 40\text{ mA}$, $0^\circ\text{C} \leq T_j \leq 125^\circ\text{C}$, $C_{IN} = 0.33\ \mu\text{F}$, $C_L = 0.1\ \mu\text{F}$)

Item	Symbol	Min	Typ	Max	Unit	Test Condition
Output voltage	V_{OUT}	-4.8	-5.0	-5.2	V	$T_j = 25^\circ\text{C}$
		-4.75	—	-5.25		$V_{IN} = -10\text{ V}$, $1.0\text{ mA} \leq I_{OUT} \leq 70\text{ mA}$
Line regulation	ΔV_{OLINE}	—	55	150	mV	$T_j = 25^\circ\text{C}$ $-20\text{ V} \leq V_{IN} \leq -7\text{ V}$
		—	45	100		$-20\text{ V} \leq V_{IN} \leq -8\text{ V}$
Load regulation	ΔV_{OLOAD}	—	16	—	mV	$T_j = 25^\circ\text{C}$ $1.0\text{ mA} \leq I_{OUT} \leq 150\text{ mA}$
		—	11	60		$1.0\text{ mA} \leq I_{OUT} \leq 100\text{ mA}$
		—	5.0	30		$1.0\text{ mA} \leq I_{OUT} \leq 40\text{ mA}$
Quiescent current	I_Q	—	2.0	4.0	mA	$T_j = 25^\circ\text{C}$
Quiescent current change	ΔI_Q	—	—	1.5	mA	$T_j = 25^\circ\text{C}$ $-20\text{ V} \leq V_{IN} \leq -8.0\text{ V}$
		—	—	1.0		$1.0\text{ mA} \leq I_{OUT} \leq 40\text{ mA}$
Voltage drop	V_{DROP}	—	1.3	—	V	$T_j = 25^\circ\text{C}$
Output short circuit current	I_{OS}	—	300	—	mA	$T_j = 25^\circ\text{C}$

HA179L06P, HA179L06, HA179L06U

($V_{IN} = -11\text{ V}$, $I_{OUT} = 40\text{ mA}$, $0^\circ\text{C} \leq T_j \leq 125^\circ\text{C}$, $C_{IN} = 0.33\ \mu\text{F}$, $C_L = 0.1\ \mu\text{F}$)

Item	Symbol	Min	Typ	Max	Unit	Test Condition
Output voltage	V_{OUT}	-5.76	-6.0	-6.24	V	$T_j = 25^\circ\text{C}$
		-5.70	—	-6.30		$V_{IN} = -11\text{ V}$, $1.0\text{ mA} \leq I_{OUT} \leq 70\text{ mA}$
Line regulation	ΔV_{OLINE}	—	50	150	mV	$T_j = 25^\circ\text{C}$ $-21\text{ V} \leq V_{IN} \leq -8.1\text{ V}$
		—	45	110		$-21\text{ V} \leq V_{IN} \leq -9.0\text{ V}$
Load regulation	ΔV_{OLOAD}	—	17.5	—	mV	$T_j = 25^\circ\text{C}$ $1.0\text{ mA} \leq I_{OUT} \leq 150\text{ mA}$
		—	12	70		$1.0\text{ mA} \leq I_{OUT} \leq 100\text{ mA}$
		—	5.5	35		$1.0\text{ mA} \leq I_{OUT} \leq 40\text{ mA}$
Quiescent current	I_Q	—	2.0	4.0	mA	$T_j = 25^\circ\text{C}$
Quiescent current change	ΔI_Q	—	—	1.5	mA	$T_j = 25^\circ\text{C}$ $-21\text{ V} \leq V_{IN} \leq -9.0\text{ V}$
		—	—	1.0		$1.0\text{ mA} \leq I_{OUT} \leq 40\text{ mA}$
Voltage drop	V_{DROP}	—	1.3	—	V	$T_j = 25^\circ\text{C}$
Output short circuit current	I_{OS}	—	300	—	mA	$T_j = 25^\circ\text{C}$

HA179L08P, HA179L08, HA179L08U

($V_{IN} = -14\text{ V}$, $I_{OUT} = 40\text{ mA}$, $0^\circ\text{C} \leq T_j \leq 125^\circ\text{C}$, $C_{IN} = 0.33\text{ }\mu\text{F}$, $C_L = 0.1\text{ }\mu\text{F}$)

Item	Symbol	Min	Typ	Max	Unit	Test Condition
Output voltage	V_{OUT}	-7.68	-8.0	-8.32	V	$T_j = 25^\circ\text{C}$
		-7.60	—	-8.40		$V_{IN} = -14\text{ V}$, $1.0\text{ mA} \leq I_{OUT} \leq 70\text{ mA}$
Line regulation	ΔV_{OLINE}	—	65	175	mV	$T_j = 25^\circ\text{C}$
		—	55	125		$-23\text{ V} \leq V_{IN} \leq -10.5\text{ V}$ $-23\text{ V} \leq V_{IN} \leq -11\text{ V}$
Load regulation	ΔV_{OLOAD}	—	22	—	mV	$T_j = 25^\circ\text{C}$
		—	15	80		$1.0\text{ mA} \leq I_{OUT} \leq 150\text{ mA}$ $1.0\text{ mA} \leq I_{OUT} \leq 100\text{ mA}$
		—	7.0	40		$1.0\text{ mA} \leq I_{OUT} \leq 40\text{ mA}$
Quiescent current	I_Q	—	2.0	4.0	mA	$T_j = 25^\circ\text{C}$
Quiescent current change	ΔI_Q	—	—	1.5	mA	$T_j = 25^\circ\text{C}$
		—	—	1.0		$-23\text{ V} \leq V_{IN} \leq -11\text{ V}$ $1.0\text{ mA} \leq I_{OUT} \leq 40\text{ mA}$
Voltage drop	V_{DROP}	—	1.3	—	V	$T_j = 25^\circ\text{C}$
Output short circuit current	I_{OS}	—	270	—	mA	$T_j = 25^\circ\text{C}$

HA179L09P, HA179L09, HA179L09U

($V_{IN} = -15\text{ V}$, $I_{OUT} = 40\text{ mA}$, $0^\circ\text{C} \leq T_j \leq 125^\circ\text{C}$, $C_{IN} = 0.33\text{ }\mu\text{F}$, $C_L = 0.1\text{ }\mu\text{F}$)

Item	Symbol	Min	Typ	Max	Unit	Test Condition
Output voltage	V_{OUT}	-8.64	-9.0	-9.36	V	$T_j = 25^\circ\text{C}$
		-8.55	—	-9.45		$V_{IN} = -15\text{ V}$, $1.0\text{ mA} \leq I_{OUT} \leq 70\text{ mA}$
Line regulation	ΔV_{OLINE}	—	80	200	mV	$T_j = 25^\circ\text{C}$
		—	70	160		$-24\text{ V} \leq V_{IN} \leq -11.4\text{ V}$ $-24\text{ V} \leq V_{IN} \leq -12\text{ V}$
Load regulation	ΔV_{OLOAD}	—	24.5	—	mV	$T_j = 25^\circ\text{C}$
		—	17	90		$1.0\text{ mA} \leq I_{OUT} \leq 150\text{ mA}$ $1.0\text{ mA} \leq I_{OUT} \leq 100\text{ mA}$
		—	8.0	45		$1.0\text{ mA} \leq I_{OUT} \leq 40\text{ mA}$
Quiescent current	I_Q	—	2.6	4.6	mA	$T_j = 25^\circ\text{C}$
Quiescent current change	ΔI_Q	—	—	1.5	mA	$T_j = 25^\circ\text{C}$
		—	—	1.0		$-24\text{ V} \leq V_{IN} \leq -12\text{ V}$ $1.0\text{ mA} \leq I_{OUT} \leq 40\text{ mA}$
Voltage drop	V_{DROP}	—	1.3	—	V	$T_j = 25^\circ\text{C}$
Output short circuit current	I_{OS}	—	270	—	mA	$T_j = 25^\circ\text{C}$

HA179L10P, HA179L10, HA179L10U

($V_{IN} = -16\text{ V}$, $I_{OUT} = 40\text{ mA}$, $0^\circ\text{C} \leq T_j \leq 125^\circ\text{C}$, $C_{IN} = 0.33\text{ }\mu\text{F}$, $C_L = 0.1\text{ }\mu\text{F}$)

Item	Symbol	Min	Typ	Max	Unit	Test Condition
Output voltage	V_{OUT}	-9.6	-10	-10.4	V	$T_j = 25^\circ\text{C}$
		-9.50	—	-10.50		$V_{IN} = -16\text{ V}$, $1.0\text{ mA} \leq I_{OUT} \leq 70\text{ mA}$
Line regulation	ΔV_{OLINE}	—	80	230	mV	$T_j = 25^\circ\text{C}$
		—	70	170		$-25\text{ V} \leq V_{IN} \leq -12.5\text{ V}$ $-25\text{ V} \leq V_{IN} \leq -13\text{ V}$
Load regulation	ΔV_{OLOAD}	—	26	—	mV	$T_j = 25^\circ\text{C}$
		—	18	90		$1.0\text{ mA} \leq I_{OUT} \leq 150\text{ mA}$ $1.0\text{ mA} \leq I_{OUT} \leq 100\text{ mA}$
		—	8.5	45		$1.0\text{ mA} \leq I_{OUT} \leq 40\text{ mA}$
Quiescent current	I_Q	—	2.6	4.6	mA	$T_j = 25^\circ\text{C}$
Quiescent current change	ΔI_Q	—	—	1.5	mA	$T_j = 25^\circ\text{C}$
		—	—	1.0		$-25\text{ V} \leq V_{IN} \leq -13\text{ V}$ $1.0\text{ mA} \leq I_{OUT} \leq 40\text{ mA}$
Voltage drop	V_{DROP}	—	1.3	—	V	$T_j = 25^\circ\text{C}$
Output short circuit current	I_{OS}	—	260	—	mA	$T_j = 25^\circ\text{C}$

HA179L12P, HA179L12, HA179L12U
 $(V_{IN} = -19\text{ V}, I_{OUT} = 40\text{ mA}, 0^{\circ}\text{C} \leq T_j \leq 125^{\circ}\text{C}, C_{IN} = 0.33\text{ }\mu\text{F}, C_L = 0.1\text{ }\mu\text{F})$

Item	Symbol	Min	Typ	Max	Unit	Test Condition
Output voltage	V_{OUT}	-11.52	-12	-12.48	V	$T_j = 25^{\circ}\text{C}$
		-11.40	—	-12.60		$V_{IN} = -19\text{ V}, 1.0\text{ mA} \leq I_{OUT} \leq 70\text{ mA}$
Line regulation	ΔV_{OLINE}	—	120	250	mV	$T_j = 25^{\circ}\text{C}$ $-27\text{ V} \leq V_{IN} \leq -14.5\text{ V}$
		—	100	200		$-27\text{ V} \leq V_{IN} \leq -16\text{ V}$
Load regulation	ΔV_{OLOAD}	—	28.5	—	mV	$T_j = 25^{\circ}\text{C}$ $1.0\text{ mA} \leq I_{OUT} \leq 150\text{ mA}$
		—	20	100		$1.0\text{ mA} \leq I_{OUT} \leq 100\text{ mA}$
		—	10	50		$1.0\text{ mA} \leq I_{OUT} \leq 40\text{ mA}$
Quiescent current	I_Q	—	2.6	4.6	mA	$T_j = 25^{\circ}\text{C}$
Quiescent current change	ΔI_Q	—	—	1.5	mA	$T_j = 25^{\circ}\text{C}$ $-27\text{ V} \leq V_{IN} \leq -16\text{ V}$
		—	—	1.0		$1.0\text{ mA} \leq I_{OUT} \leq 40\text{ mA}$
Voltage drop	V_{DROP}	—	1.3	—	V	$T_j = 25^{\circ}\text{C}$
Output short circuit current	I_{OS}	—	250	—	mA	$T_j = 25^{\circ}\text{C}$

HA179L15P, HA179L15, HA179L15U
 $(V_{IN} = -23\text{ V}, I_{OUT} = 40\text{ mA}, 0^{\circ}\text{C} \leq T_j \leq 125^{\circ}\text{C}, C_{IN} = 0.33\text{ }\mu\text{F}, C_L = 0.1\text{ }\mu\text{F})$

Item	Symbol	Min	Typ	Max	Unit	Test Condition
Output voltage	V_{OUT}	-14.4	-15	-15.6	V	$T_j = 25^{\circ}\text{C}$
		-14.25	—	-15.75		$V_{IN} = -23\text{ V}, 1.0\text{ mA} \leq I_{OUT} \leq 70\text{ mA}$
Line regulation	ΔV_{OLINE}	—	130	300	mV	$T_j = 25^{\circ}\text{C}$ $-30\text{ V} \leq V_{IN} \leq -17.5\text{ V}$
		—	110	250		$-30\text{ V} \leq V_{IN} \leq -20\text{ V}$
Load regulation	ΔV_{OLOAD}	—	36	—	mV	$T_j = 25^{\circ}\text{C}$ $1.0\text{ mA} \leq I_{OUT} \leq 150\text{ mA}$
		—	25	150		$1.0\text{ mA} \leq I_{OUT} \leq 100\text{ mA}$
		—	12	75		$1.0\text{ mA} \leq I_{OUT} \leq 40\text{ mA}$
Quiescent current	I_Q	—	2.6	4.6	mA	$T_j = 25^{\circ}\text{C}$
Quiescent current change	ΔI_Q	—	—	1.5	mA	$T_j = 25^{\circ}\text{C}$ $-30\text{ V} \leq V_{IN} \leq -20\text{ V}$
		—	—	1.0		$1.0\text{ mA} \leq I_{OUT} \leq 40\text{ mA}$
Voltage drop	V_{DROP}	—	1.3	—	V	$T_j = 25^{\circ}\text{C}$
Output short circuit current	I_{OS}	—	240	—	mA	$T_j = 25^{\circ}\text{C}$

Characteristic Curves

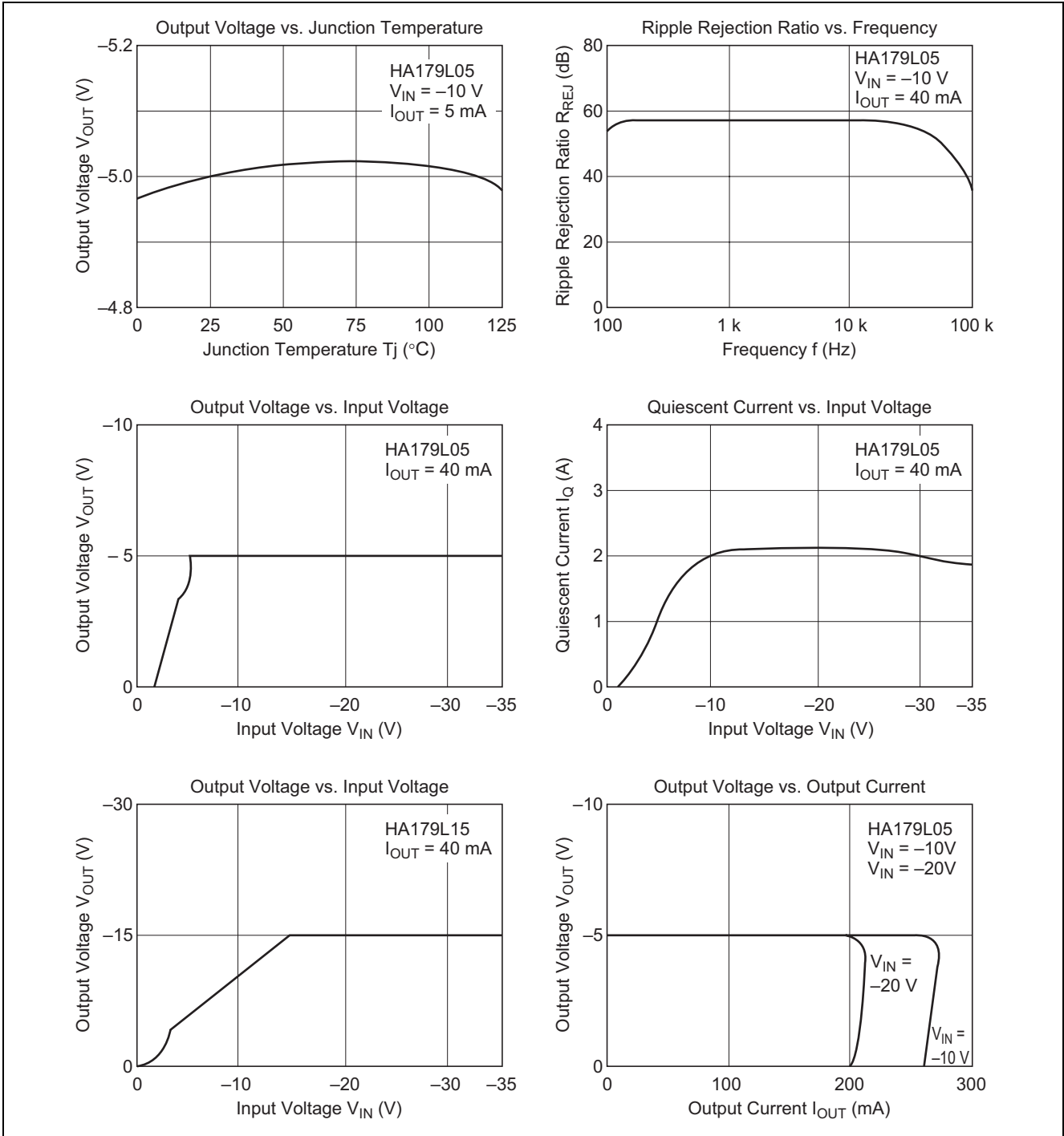

Package Dimensions

Package Name	JEITA Package Code	RENESAS Code	Previous Code	MASS[Typ.]
UPAK	SC-62	PLZZ0004CA-A	UPAK / UPAKV	0.050g

Unit: mm

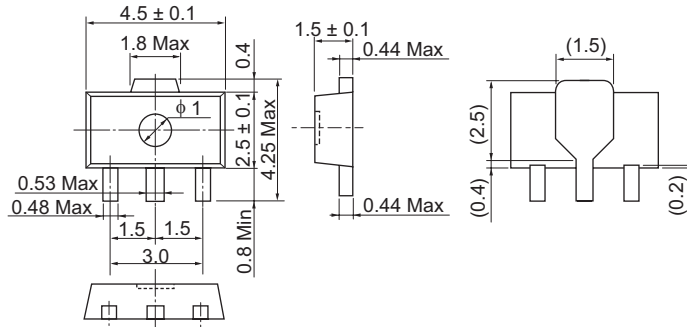

Package Name	JEITA Package Code	RENESAS Code	Previous Code	MASS[Typ.]
TO-92 Mod	SC-51	PRSS0003DC-A	TO-92 Mod / TO-92 ModV	0.35g

Unit: mm

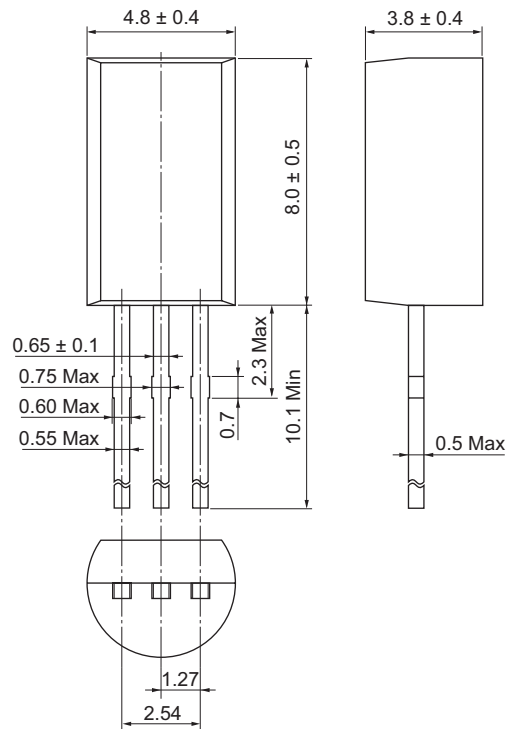

Notes:

1. This document is provided for reference purposes only so that Renesas customers may select the appropriate Renesas products for their use. Renesas neither makes warranties or representations with respect to the accuracy or completeness of the information contained in this document nor grants any license to any intellectual property rights or any other rights of Renesas or any third party with respect to the information in this document.
2. Renesas shall have no liability for damages or infringement of any intellectual property or other rights arising out of the use of any information in this document, including, but not limited to, product data, diagrams, charts, programs, algorithms, and application circuit examples.
3. You should not use the products or the technology described in this document for the purpose of military applications such as the development of weapons of mass destruction or for the purpose of any other military use. When exporting the products or technology described herein, you should follow the applicable export control laws and regulations, and procedures required by such laws and regulations.
4. All information included in this document such as product data, diagrams, charts, programs, algorithms, and application circuit examples, is current as of the date this document is issued. Such information, however, is subject to change without any prior notice. Before purchasing or using any Renesas products listed in this document, please confirm the latest product information with a Renesas sales office. Also, please pay regular and careful attention to additional and different information to be disclosed by Renesas such as that disclosed through our website. (<http://www.renesas.com>)
5. Renesas has used reasonable care in compiling the information included in this document, but Renesas assumes no liability whatsoever for any damages incurred as a result of errors or omissions in the information included in this document.
6. When using or otherwise relying on the information in this document, you should evaluate the information in light of the total system before deciding about the applicability of such information to the intended application. Renesas makes no representations, warranties or guaranties regarding the suitability of its products for any particular application and specifically disclaims any liability arising out of the application and use of the information in this document or Renesas products.
7. With the exception of products specified by Renesas as suitable for automobile applications, Renesas products are not designed, manufactured or tested for applications or otherwise in systems the failure or malfunction of which may cause a direct threat to human life or create a risk of human injury or which require especially high quality and reliability such as safety systems, or equipment or systems for transportation and traffic, healthcare, combustion control, aerospace and aeronautics, nuclear power, or undersea communication transmission. If you are considering the use of our products for such purposes, please contact a Renesas sales office beforehand. Renesas shall have no liability for damages arising out of the uses set forth above.
8. Notwithstanding the preceding paragraph, you should not use Renesas products for the purposes listed below:
 - (1) artificial life support devices or systems
 - (2) surgical implantations
 - (3) healthcare intervention (e.g., excision, administration of medication, etc.)
 - (4) any other purposes that pose a direct threat to human lifeRenesas shall have no liability for damages arising out of the uses set forth in the above and purchasers who elect to use Renesas products in any of the foregoing applications shall indemnify and hold harmless Renesas Technology Corp., its affiliated companies and their officers, directors, and employees against any and all damages arising out of such applications.
9. You should use the products described herein within the range specified by Renesas, especially with respect to the maximum rating, operating supply voltage range, movement power voltage range, heat radiation characteristics, installation and other product characteristics. Renesas shall have no liability for malfunctions or damages arising out of the use of Renesas products beyond such specified ranges.
10. Although Renesas endeavors to improve the quality and reliability of its products, IC products have specific characteristics such as the occurrence of failure at a certain rate and malfunctions under certain use conditions. Please be sure to implement safety measures to guard against the possibility of physical injury, and injury or damage caused by fire in the event of the failure of a Renesas product, such as safety design for hardware and software including but not limited to redundancy, fire control and malfunction prevention, appropriate treatment for aging degradation or any other applicable measures. Among others, since the evaluation of microcomputer software alone is very difficult, please evaluate the safety of the final products or system manufactured by you.
11. In case Renesas products listed in this document are detached from the products to which the Renesas products are attached or affixed, the risk of accident such as swallowing by infants and small children is very high. You should implement safety measures so that Renesas products may not be easily detached from your products. Renesas shall have no liability for damages arising out of such detachment.
12. This document may not be reproduced or duplicated, in any form, in whole or in part, without prior written approval from Renesas.
13. Please contact a Renesas sales office if you have any questions regarding the information contained in this document, Renesas semiconductor products, or if you have any other inquiries.



RENESAS SALES OFFICES

<http://www.renesas.com>

Refer to "<http://www.renesas.com/en/network>" for the latest and detailed information.

Renesas Technology America, Inc.

450 Holger Way, San Jose, CA 95134-1368, U.S.A
Tel: <1> (408) 382-7500, Fax: <1> (408) 382-7501

Renesas Technology Europe Limited

Dukes Meadow, Millboard Road, Bourne End, Buckinghamshire, SL8 5FH, U.K.
Tel: <44> (1628) 585-100, Fax: <44> (1628) 585-900

Renesas Technology (Shanghai) Co., Ltd.

Unit 204, 205, AZIACenter, No.1233 Lujiazui Ring Rd, Pudong District, Shanghai, China 200120
Tel: <86> (21) 5877-1818, Fax: <86> (21) 6887-7898

Renesas Technology Hong Kong Ltd.

7th Floor, North Tower, World Finance Centre, Harbour City, 1 Canton Road, Tsimshatsui, Kowloon, Hong Kong
Tel: <852> 2265-6688, Fax: <852> 2730-6071

Renesas Technology Taiwan Co., Ltd.

10th Floor, No.99, Fushing North Road, Taipei, Taiwan
Tel: <886> (2) 2715-2888, Fax: <886> (2) 2713-2999

Renesas Technology Singapore Pte. Ltd.

1 Harbour Front Avenue, #06-10, Keppel Bay Tower, Singapore 098632
Tel: <65> 6213-0200, Fax: <65> 6278-8001

Renesas Technology Korea Co., Ltd.

Kukje Center Bldg. 18th Fl., 191, 2-ka, Hangang-ro, Yongsan-ku, Seoul 140-702, Korea
Tel: <82> (2) 796-3115, Fax: <82> (2) 796-2145

Renesas Technology Malaysia Sdn. Bhd

Unit 906, Block B, Menara Amcorp, Amcorp Trade Centre, No.18, Jalan Persiaran Barat, 46050 Petaling Jaya, Selangor Darul Ehsan, Malaysia
Tel: <603> 7955-9390, Fax: <603> 7955-9510

X-ON Electronics

Largest Supplier of Electrical and Electronic Components

Click to view similar products for [Linear Voltage Regulators](#) category:

Click to view products by [Renesas](#) manufacturer:

Other Similar products are found below :

[LV56831P-E](#) [LV5684PVD-XH](#) [MAX202ECWE-LF](#) [MCDTSA6-2R](#) [L4953G](#) [L7815ACV-DG](#) [PQ3DZ53U](#) [LV56801P-E](#)
[TCR3DF13,LM\(CT](#) [TCR3DF39,LM\(CT](#) [TLE42794G](#) [L78L05CZ/1SX](#) [L78LR05DL-MA-E](#) [L78MR05-E](#) [033150D](#) [033151B](#) [090756R](#)
[636416C](#) [NCV78M15BDTG](#) [702482B](#) [714954EB](#) [TLE42794GM](#) [TLE42994GM](#) [ZMR500QFTA](#) [BA033LBSG2-TR](#)
[NCV78M05ABDTRKG](#) [NCV78M08BDTRKG](#) [NCP7808TG](#) [NCV571SN12T1G](#) [LV5680P-E](#) [CAJ24C256YI-GT3](#) [L78M15CV-DG](#) [L9474N](#)
[TLS202B1MBV33HTSA1](#) [L79M05T-E](#) [NCP571SN09T1G](#) [MAX15006AASA/V+](#) [MIC5283-5.0YML-T5](#) [L4969URTR-E](#) [L78LR05D-MA-E](#)
[NCV7808BDTRKG](#) [L9466N](#) [NCP7805ETG](#) [SC7812CTG](#) [NCV7809BTG](#) [NCV571SN09T1G](#) [NCV317MBTG](#) [MC78M15CDTT5G](#)
[MC78M12CDTT5G](#) [L9468N](#)