

HA-5127, HA-5127A

8.5MHz, Ultra-Low Noise Precision Operational Amplifier

FN2906  
Rev 8.00  
November 29, 2011

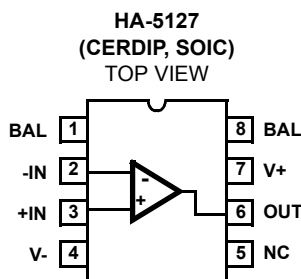
The HA-5127 monolithic operational amplifier features an unparalleled combination of precision DC and wideband high speed characteristics. Utilizing the Intersil D. I. technology and advanced processing techniques, this unique design unites low noise ( $3nV/\sqrt{Hz}$ ) precision instrumentation performance with high speed ( $10V/\mu s$ ) wideband capability.

This amplifier's impressive list of features include low  $V_{OS}$  ( $10\mu V$ ), wide unity gain-bandwidth (8.5MHz), high open loop gain (1800V/mV), and high CMRR (126dB). Additionally, this flexible device operates over a wide supply range ( $\pm 5V$  to  $\pm 15V$ ) while consuming only 140mW of power.

Using the HA-5127 allows designers to minimize errors while maximizing speed and bandwidth.

This device is ideally suited for low level transducer signal amplifier circuits. Other applications which can utilize the HA-5127's qualities include instrumentation amplifiers, pulse amplifiers, audio preamplifiers, and signal conditioning circuits. This device can easily be used as a design enhancement by directly replacing the 725, OP25, OP06, OP07, OP27 and OP37. For the military grade product, refer to the HA-5127/883 data sheet.

Pinout



Features

- Slew Rate . . . . . 10V/ $\mu s$
- Unity Gain Bandwidth . . . . . 8.5MHz
- Low Noise . . . . .  $3nV/\sqrt{Hz}$  at 1kHz
- Low  $V_{OS}$  . . . . . 10 $\mu V$
- High CMRR . . . . . 126dB
- High Gain . . . . . 1800V/mV
- Pb-Free Available (RoHS Compliant)

Applications

- High Speed Signal Conditioners
- Wide Bandwidth Instrumentation Amplifiers
- Low Level Transducer Amplifiers
- Fast, Low Level Voltage Comparators
- Highest Quality Audio Preamplifiers
- Pulse/RF Amplifiers

Ordering Information

PART NUMBER (Note 3)	PART MARKING	TEMP. RANGE (°C)	PACKAGE	PKG. DWG. #
HA7-5127A-5 (Note 4)	HA7- 5127A-5	0 to +75	8 Ld CERDIP	F8.3A
HA9P5127-5 (Note 4)	5127 5	0 to +75	8 Ld SOIC	M8.15
HA9P5127-5Z (Note 1)	5127 5Z	0 to +75	8 Ld SOIC (Pb-free)	M8.15
HA9P5127-5ZX96 (Notes 1, 2)	5127 5Z	8 Ld SOIC (Pb-free)		M8.15

NOTES:

1. These Intersil Pb-free plastic packaged products employ special Pb-free material sets, molding compounds/die attach materials, and 100% matte tin plate plus anneal (e3 termination finish, which is RoHS compliant and compatible with both SnPb and Pb-free soldering operations). Intersil Pb-free products are MSL classified at Pb-free peak reflow temperatures that meet or exceed the Pb-free requirements of IPC/JEDEC J STD-020.
2. Please refer to [TB347](#) for details on reel specifications.
3. For Moisture Sensitivity Level (MSL), please see device information page for [HA-5127](#), [HA-5127A](#). For more information on MSL please see techbrief [TB363](#).
4. Not recommended for new designs.

**Absolute Maximum Ratings**

Supply Voltage Between V+ and V- Terminals . . . . . 44V  
 Differential Input Voltage (Note 7) . . . . . 0.7V  
 Output Current . . . . . Full Short Circuit Protection

## Operating Conditions

Temperature Range  
 HA5127/27A-5 . . . . . 0°C to +75°C

**Thermal Information**

Thermal Resistance (Typical, Note 6)  $\theta_{JA}$  (°C/W)  $\theta_{JC}$  (°C/W)  
 CERDIP Package . . . . . 115 28  
 SOIC Package . . . . . 157 N/A  
 Maximum Junction Temperature (Ceramic Package, Note 5) . . +175°C  
 Maximum Junction Temperature (Plastic Package) . . . . . +150°C  
 Maximum Storage Temperature Range . . . . . -65°C to +150°C  
 Pb-Free Reflow Profile . . . . . see link below  
<http://www.intersil.com/pbfree/Pb-FreeReflow.asp>

**CAUTION:** Do not operate at or near the maximum ratings listed for extended periods of time. Exposure to such conditions may adversely impact product reliability and result in failures not covered by warranty.

## NOTES:

- Maximum power dissipation, including output load must be designed to maintain the maximum junction temperature below +175°C for Hermetic packages, and below +150°C for the plastic packages.
- $\theta_{JA}$  is measured with the component mounted on a low effective thermal conductivity test board in free air. See Tech Brief [TB379](#) for details.
- For differential input voltages greater than 0.7V, the input current must be limited to 25mA to protect the back-to-back input diodes.

**Electrical Specifications**  $V_{SUPPLY} = \pm 15V$ ,  $C_L < 50pF$ ,  $R_S < 100\Omega$ . **Boldface limits apply over the operating temperature range, 0°C to +75°C.**

PARAMETER	TEST CONDITIONS	TEMP. (°C)	HA-5127A			HA-5127			UNITS
			MIN (Note 13)	TYP	MAX (Note 13)	MIN (Note 13)	TYP	MAX (Note 13)	
<b>INPUT CHARACTERISTICS</b>									
Offset Voltage		25	-	10	25	-	30	-	$\mu V$
		Full	-	30	<b>60</b>	-	70	<b>300</b>	$\mu V$
Average Offset Voltage Drift		Full	-	0.2	<b>0.6</b>	-	0.4	<b>1.8</b>	$\mu V/^\circ C$
Bias Current		25	-	$\pm 10$	$\pm 40$	-	$\pm 15$	$\pm 80$	nA
		Full	-	$\pm 20$	<b><math>\pm 60</math></b>	-	$\pm 35$	<b><math>\pm 150</math></b>	nA
Offset Current		25	-	7	35	-	12	75	nA
		Full	-	15	<b>50</b>	-	30	<b>135</b>	nA
Common Mode Range		Full	<b><math>\pm 10.3</math></b>	$\pm 11.5$	-	$\pm 10.3$	$\pm 11.5$	-	V
Differential Input Resistance (Note 8)		25	1.5	6	-	0.8	4	-	M $\Omega$
Input Noise Voltage (Note 9)	0.1Hz to 10Hz	25	-	0.08	0.18	-	0.09	0.25	$\mu V_{P-P}$
Input Noise Voltage Density	f = 10Hz	25	-	3.5	8.0	-	3.8	8.0	$nV/\sqrt{Hz}$
	f = 100Hz		-	3.1	4.5	-	3.3	4.5	$nV/\sqrt{Hz}$
	f = 1000Hz		-	3.0	3.8	-	3.2	3.8	$nV/\sqrt{Hz}$
Input Noise Current Density	f = 10Hz	25	-	1.7	4.0	-	1.7	-	$pA/\sqrt{Hz}$
	f = 100Hz		-	1.0	2.3	-	1.0	-	$pA/\sqrt{Hz}$
	f = 1000Hz		-	0.4	0.6	-	0.4	0.6	$pA/\sqrt{Hz}$
<b>TRANSFER CHARACTERISTICS</b>									
Large Signal Voltage Gain	$V_{OUT} = \pm 10V$ , $R_L = 2k\Omega$	25	1000	1800	-	700	1500	-	V/mV
		Full	<b>600</b>	1200	-	300	800	-	V/mV
Common Mode Rejection Ratio	$V_{CM} = \pm 10V$	Full	<b>114</b>	126	-	100	120	-	dB
Minimum Stable Gain		25	1	-	-	1	-	-	V/V
Unity-Gain-Bandwidth		25	5	8.5	-	5	8.5	-	MHz
<b>OUTPUT CHARACTERISTICS</b>									
Output Voltage Swing	$R_L = 600\Omega$	25	$\pm 10.0$	$\pm 11.5$	-	$\pm 10.0$	$\pm 11.5$	-	V
	$R_L = 2k\Omega$	Full	<b><math>\pm 11.7</math></b>	$\pm 13.8$	-	$\pm 11.5$	$\pm 13.5$	-	V
Full Power Bandwidth (Note 10)		25	111	160	-	111	160	-	kHz
Output Resistance	Open Loop	25	-	70	-	-	70	-	$\Omega$
Output Current		25	16.5	25	-	16.5	25	-	mA

**Electrical Specifications**  $V_{SUPPLY} = \pm 15V$ ,  $C_L < 50pF$ ,  $R_S < 100\Omega$ . **Boldface limits apply over the operating temperature range, 0°C to +75°C. (Continued)**

PARAMETER	TEST CONDITIONS	TEMP. (°C)	HA-5127A			HA-5127			UNITS
			MIN (Note 13)	TYP	MAX (Note 13)	MIN (Note 13)	TYP	MAX (Note 13)	
<b>TRANSIENT RESPONSE</b> (Note 11)									
Rise Time		25	-	-	150	-	-	150	ns
Slew Rate	$V_{OUT} = 10V$	25	7	10	-	7	10	-	V/ $\mu s$
Settling Time (Note 12)		25	-	1.5	-	-	1.5	-	$\mu s$
Overshoot		25	-	20	40	-	20	40	%
<b>POWER SUPPLY CHARACTERISTICS</b>									
Supply Current		25	-	3.5	-	-	3.5	-	mA
		Full	-	-	<b>4.0</b>	-	-	<b>4.0</b>	mA
Power Supply Rejection Ratio	$V_S = \pm 4.5V$ to $\pm 18V$	Full	-	2	<b>4</b>	-	16	<b>51</b>	$\mu V/V$

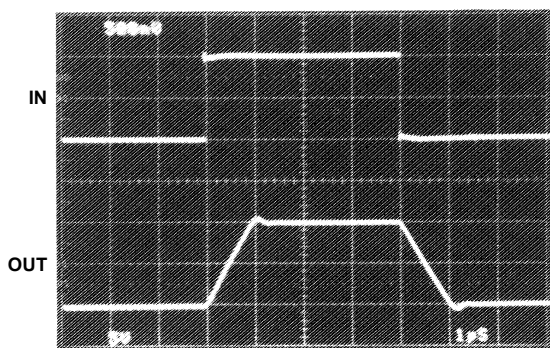
NOTES:

8. This parameter value is based upon design calculations.
9. Refer to Typical Performance Curves.
10. Full power bandwidth guaranteed based on slew rate measurement using:  $FPBW = \frac{Slew\ Rate}{2\pi V_{PEAK}}$ .
11. Refer to "Test Circuits and Waveforms" on page 3.
12. Settling time is specified to 0.1% of final value for a 10V output step and  $A_V = -1$ .
13. Compliance to datasheet limits is assured by one or more methods: production test, characterization and/or design.

**Test Circuits and Waveforms**

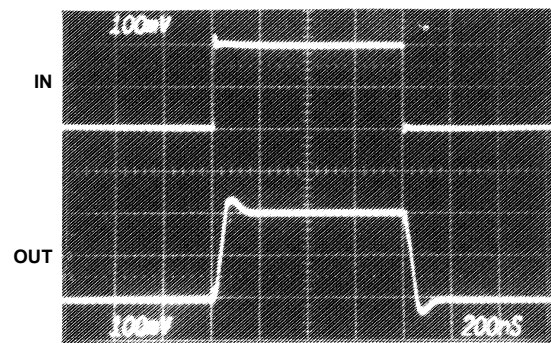


FIGURE 1. LARGE AND SMALL SIGNAL RESPONSE TEST CIRCUITS



Vertical Scale: Input = 0.5V/Div., Output = 5V/Div.  
Horizontal Scale: 1 $\mu s$ /Div.

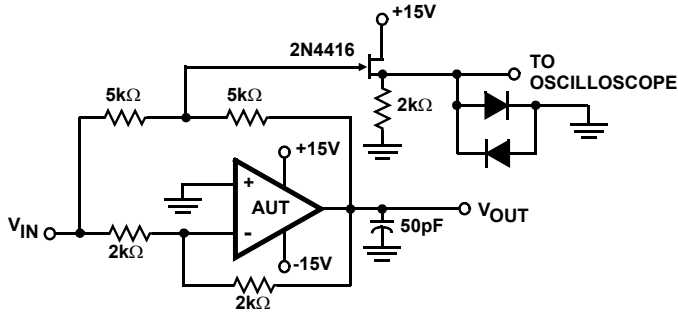
LARGE SIGNAL RESPONSE



Vertical Scale: 100mV/Div.  
Horizontal Scale: 200ns/Div.

SMALL SIGNAL RESPONSE

**Test Circuits and Waveforms** (Continued)

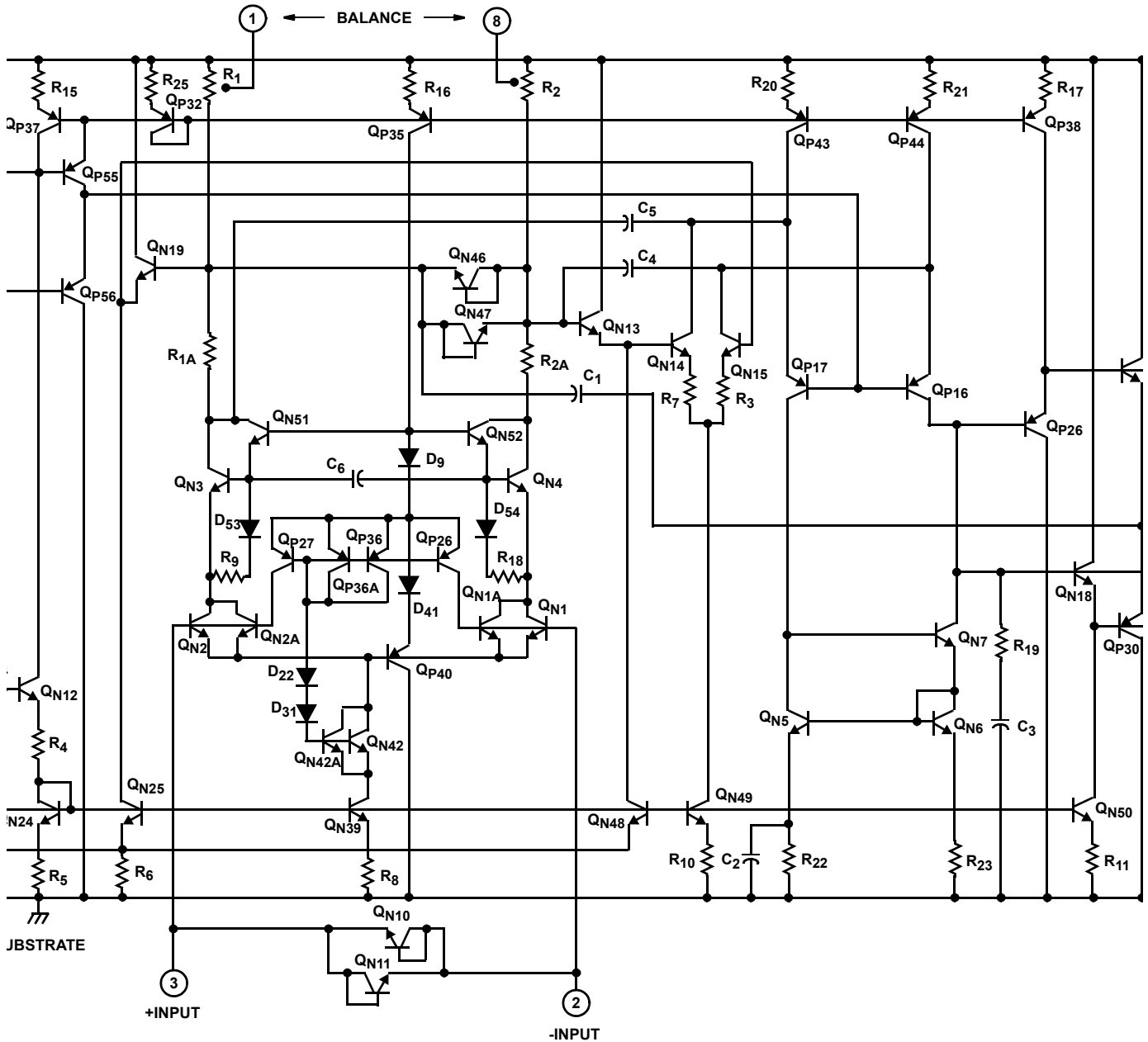


NOTES:

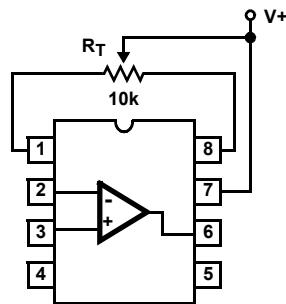
- 14.  $A_V = -1$ .
- 15. Feedback and summing resistors should be 0.1% matched.
- 16. Clipping diodes are optional. HP5082-2810 recommended.

FIGURE 2. SETTLING TIME TEST CIRCUIT

**Schematic Diagram**



**Application Information**



NOTE: Tested Offset Adjustment Range is  $|V_{OS} + 1\text{mV}|$  minimum referred to output. Typical range is  $\pm 4\text{mV}$  with  $R_T = 10\text{k}\Omega$ .

**FIGURE 3. SUGGESTED OFFSET VOLTAGE ADJUSTMENT**



Low resistances are preferred for low noise applications as a  $1\text{k}\Omega$  resistor has  $4\text{nV}/\sqrt{\text{Hz}}$  of thermal noise. Total resistances of greater than  $10\text{k}\Omega$  on either input can reduce stability. In most high resistance applications, a few picofarads of capacitance across the feedback resistor will improve stability.

**FIGURE 4. SUGGESTED STABILITY CIRCUITS**

**Typical Performance Curves** Unless Otherwise Specified:  $T_A = +25^\circ\text{C}$ ,  $V_{\text{SUPPLY}} = \pm 15\text{V}$

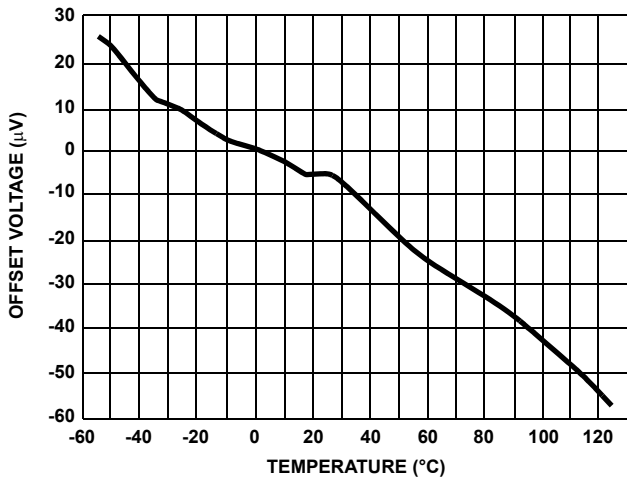


FIGURE 5. TYPICAL OFFSET VOLTAGE DRIFT vs TEMPERATURE

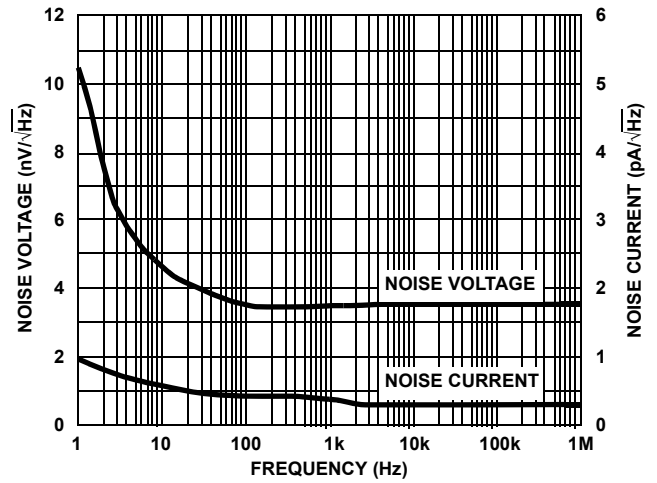


FIGURE 6. NOISE CHARACTERISTICS

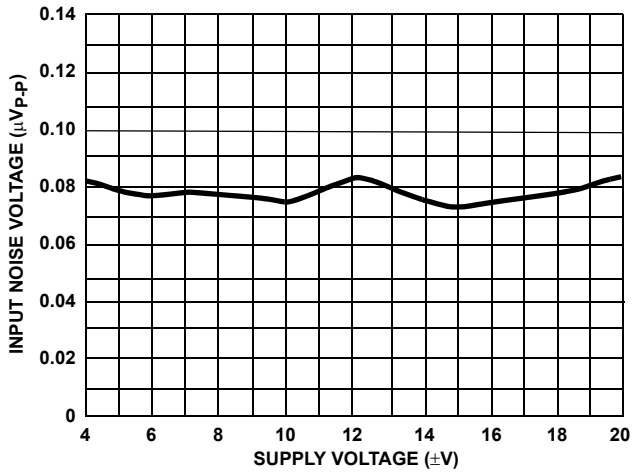


FIGURE 7. NOISE vs SUPPLY VOLTAGE

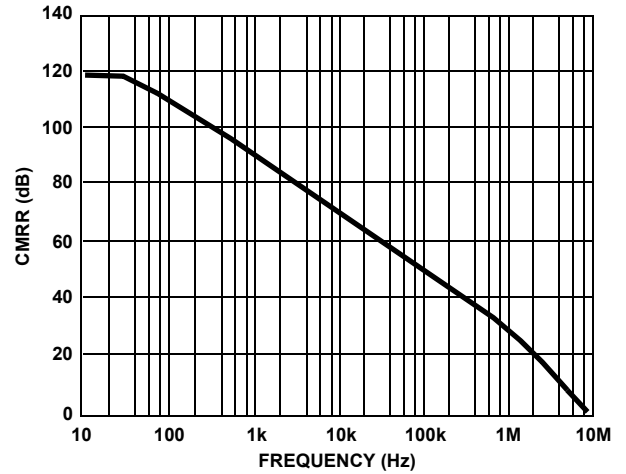


FIGURE 8. CMRR vs FREQUENCY

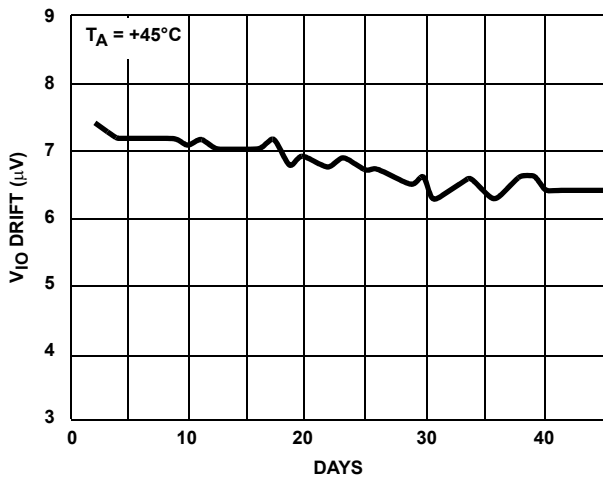


FIGURE 9. OFFSET VOLTAGE DRIFT vs TIME

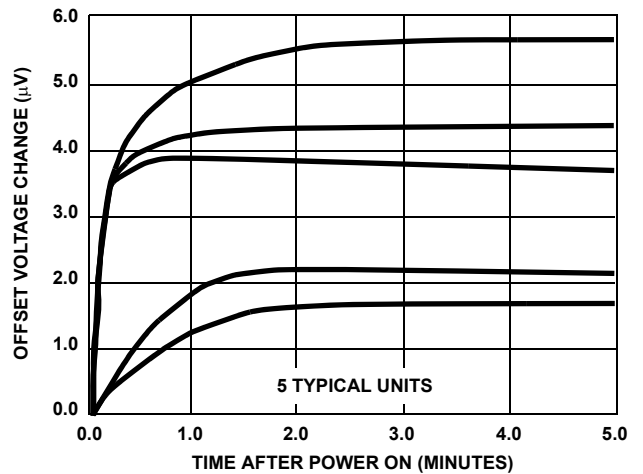


FIGURE 10. OFFSET VOLTAGE WARM UP DRIFT

**Typical Performance Curves** Unless Otherwise Specified:  $T_A = +25^\circ\text{C}$ ,  $V_{\text{SUPPLY}} = \pm 15\text{V}$  (Continued)

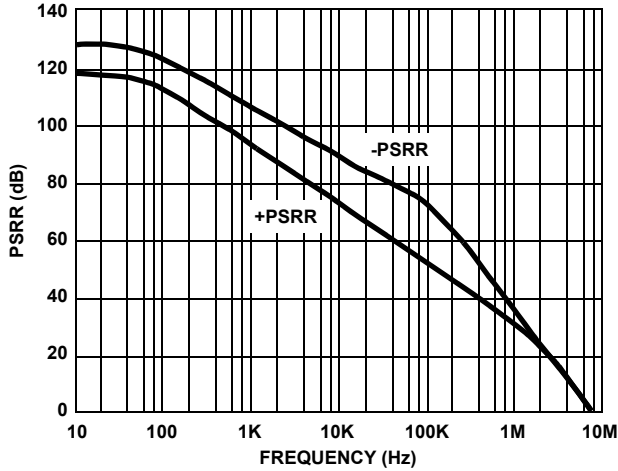


FIGURE 11. PSRR vs FREQUENCY

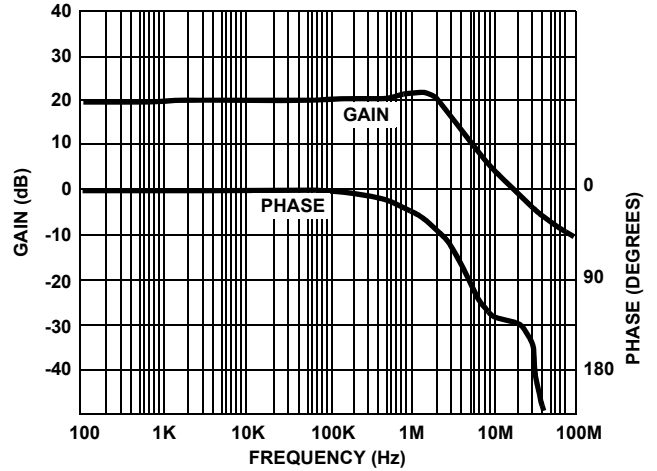


FIGURE 12. CLOSED LOOP GAIN AND PHASE vs FREQUENCY

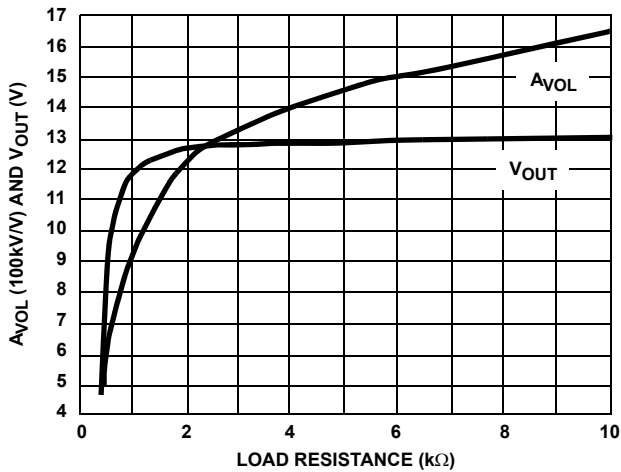


FIGURE 13.  $A_{\text{VOL}}$  AND  $V_{\text{OUT}}$  vs LOAD RESISTANCE

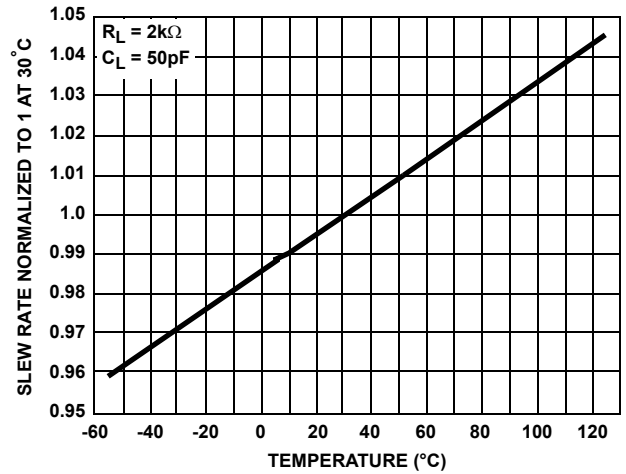


FIGURE 14. NORMALIZED SLEW RATE vs TEMPERATURE

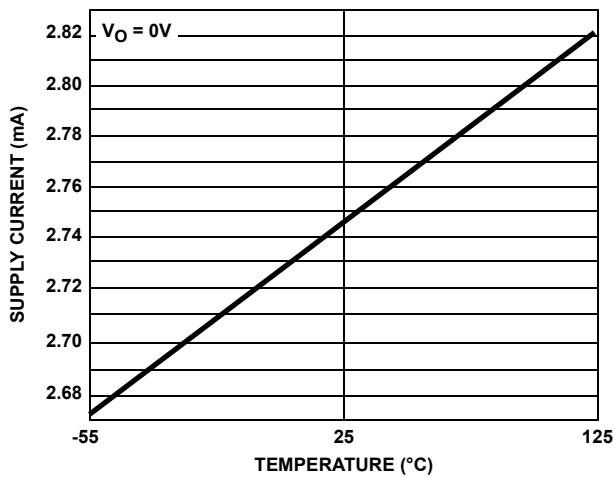


FIGURE 15. SUPPLY CURRENT vs TEMPERATURE

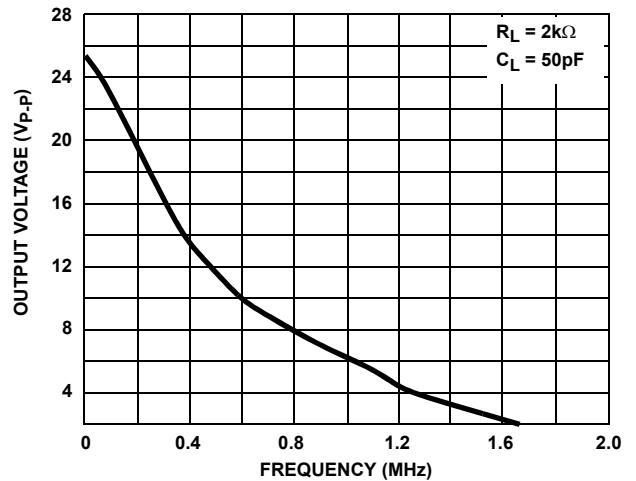


FIGURE 16. MAX UNDISTORTED SINEWAVE OUTPUT vs FREQUENCY

**Typical Performance Curves** Unless Otherwise Specified:  $T_A = +25^\circ\text{C}$ ,  $V_{\text{SUPPLY}} = \pm 15\text{V}$  (Continued)

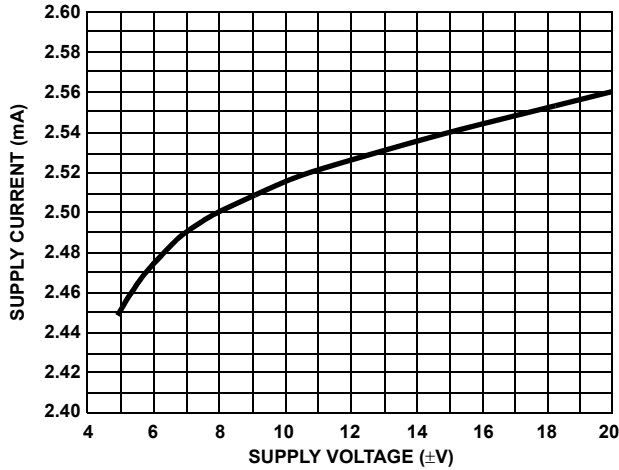


FIGURE 17. SUPPLY CURRENT vs SUPPLY VOLTAGE

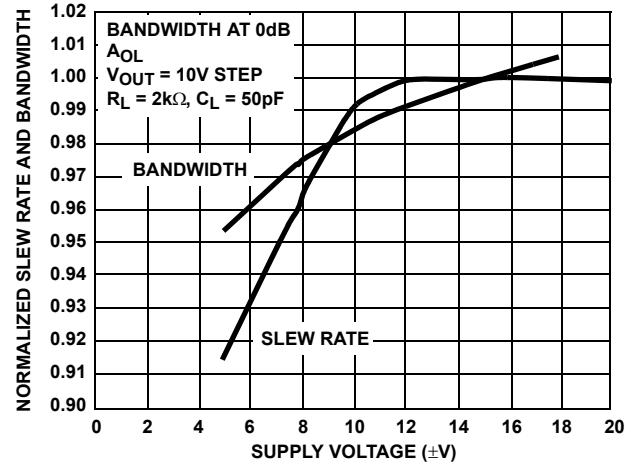


FIGURE 18. BANDWIDTH AND SLEW RATE vs SUPPLY VOLTAGE

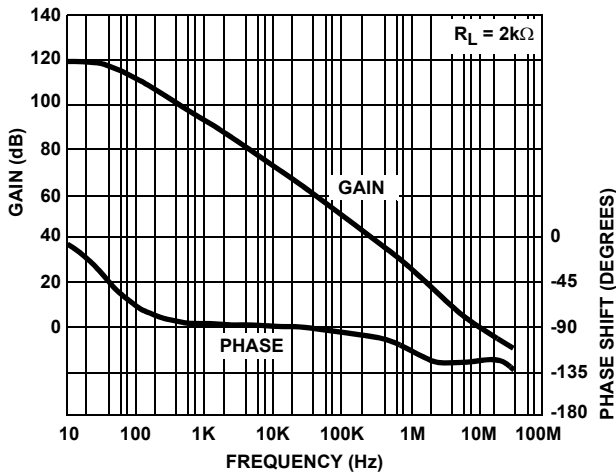


FIGURE 19. OPEN LOOP GAIN AND PHASE

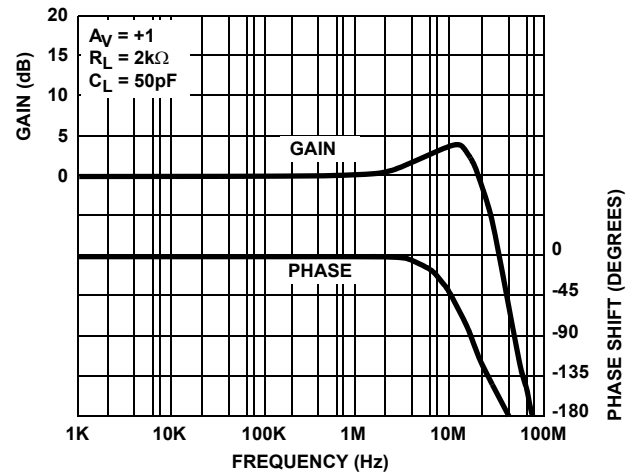
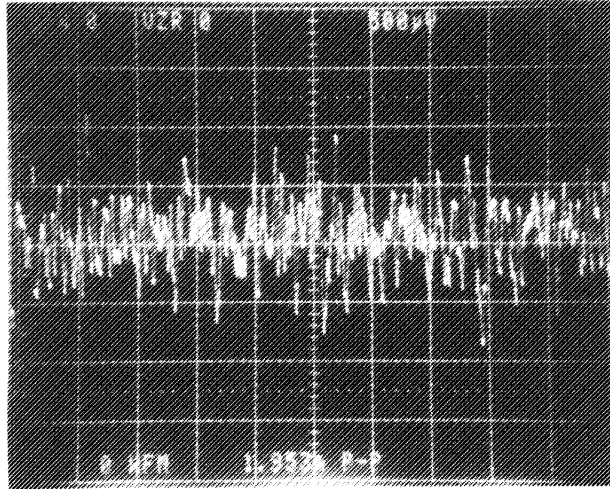


FIGURE 20. CLOSED LOOP GAIN AND PHASE



**Typical Performance Curves** Unless Otherwise Specified:  $T_A = +25^\circ\text{C}$ ,  $V_{\text{SUPPLY}} = \pm 15\text{V}$  (Continued)



Horizontal Scale = 1s/Div.  
Vertical Scale = 0.002 $\mu\text{V}$ /Div.  
 $A_{\text{CL}} = 25,000\text{V/V}$ ,  $E_{\text{N}} = 0.08\mu\text{V}_{\text{P-P RTI}}$

**FIGURE 21. PEAK-TO-PEAK NOISE VOLTAGE (0.1Hz TO 10Hz)**

## Die Characteristics

### DIE DIMENSIONS:

104 mils x 65 mils x 19 mils  
2650 $\mu$ m x 1650 $\mu$ m x 483 $\mu$ m

### METALLIZATION:

Type: Al, 1% Cu  
Thickness: 16k $\text{\AA}$   $\pm$ 2k $\text{\AA}$

### SUBSTRATE POTENTIAL (Powered Up):

V-

### PASSIVATION:

Type: Nitride ( $\text{Si}_3\text{N}_4$ ) over Silox ( $\text{SiO}_2$ , 5% Phos.)  
Silox Thickness: 12k $\text{\AA}$   $\pm$ 2k $\text{\AA}$   
Nitride Thickness: 3.5k $\text{\AA}$   $\pm$ 1.5k $\text{\AA}$

### TRANSISTOR COUNT:

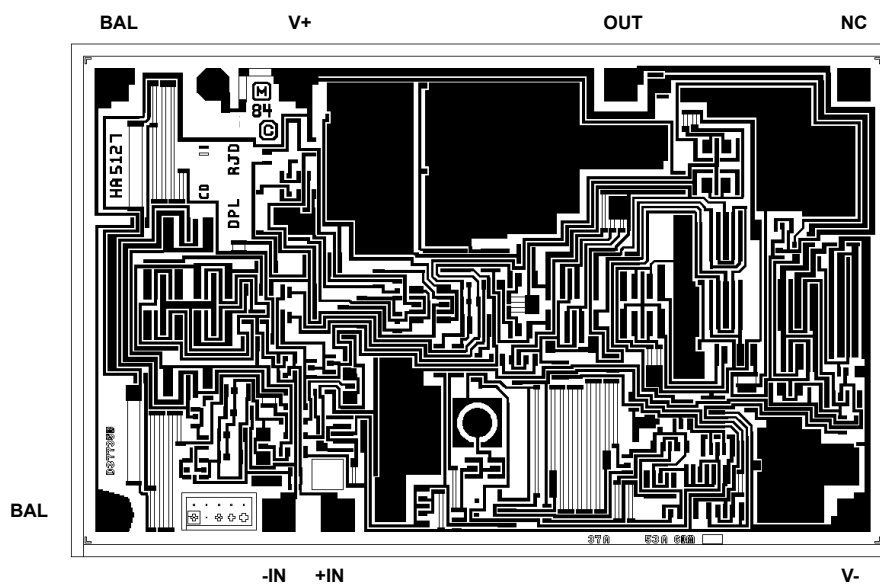
63

### PROCESS:

Bipolar Dielectric Isolation

## Metallization Mask Layout

HA-5127

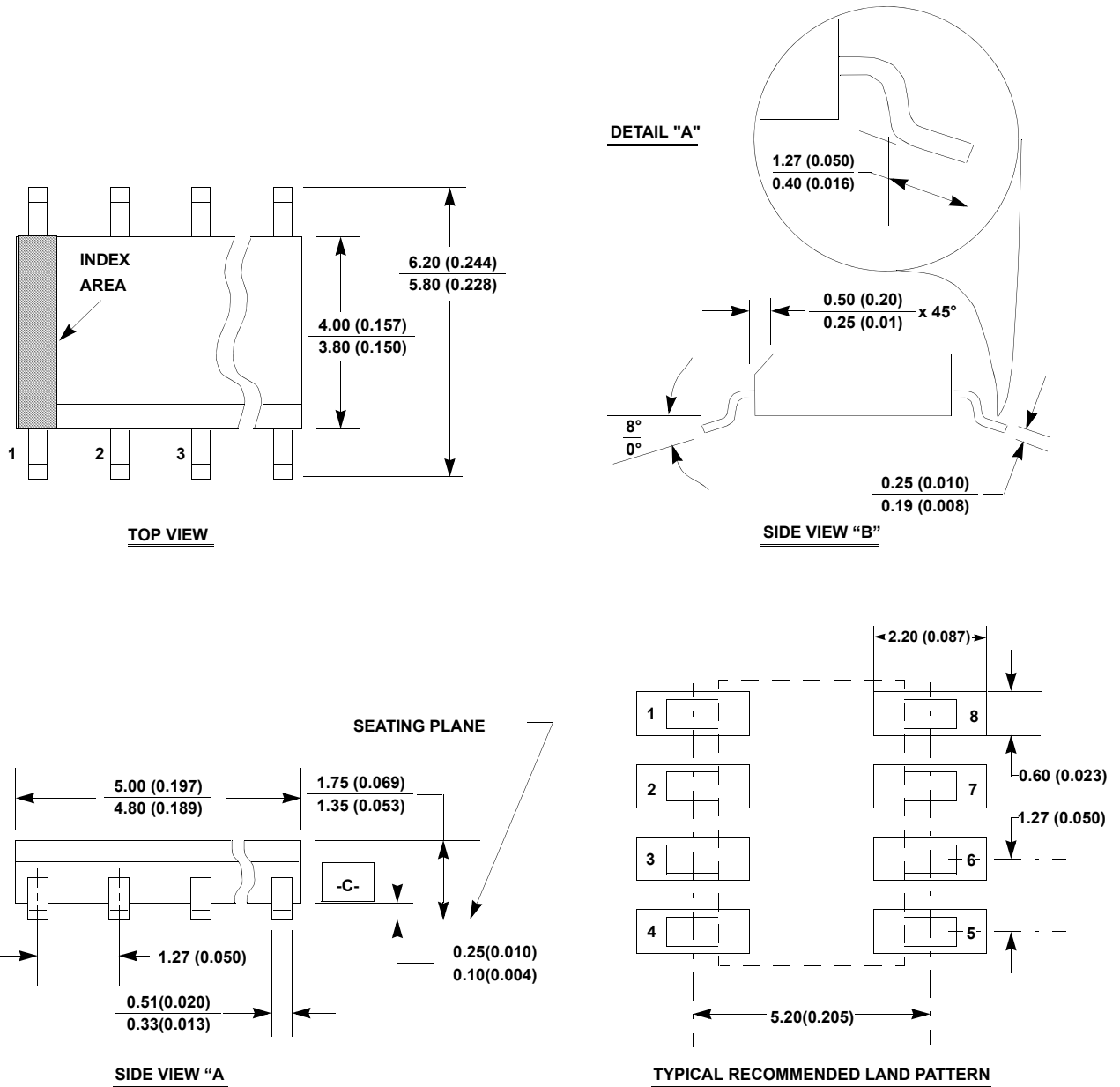


# Package Outline Drawing

## M8.15

8 LEAD NARROW BODY SMALL OUTLINE PLASTIC PACKAGE

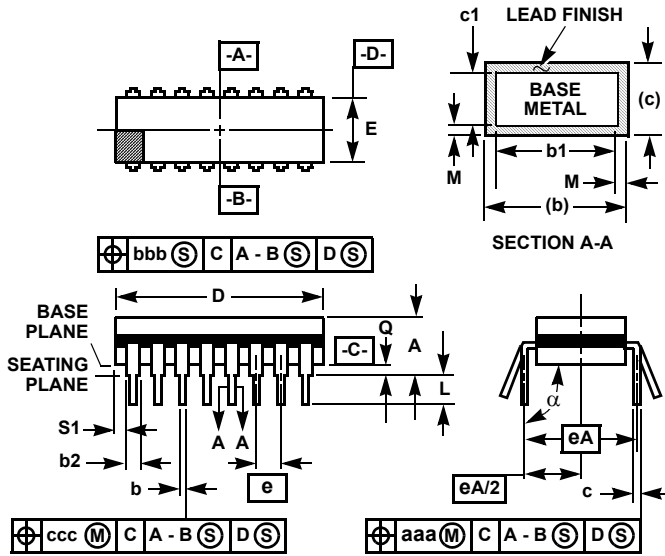
Rev 3, 3/11



**NOTES:**

1. Dimensioning and tolerancing per ANSI Y14.5M-1982.
2. Package length does not include mold flash, protrusions or gate burrs. Mold flash, protrusion and gate burrs shall not exceed 0.15mm (0.006 inch) per side.
3. Package width does not include interlead flash or protrusions. Interlead flash and protrusions shall not exceed 0.25mm (0.010 inch) per side.
4. The chamfer on the body is optional. If it is not present, a visual index feature must be located within the crosshatched area.
5. Terminal numbers are shown for reference only.
6. The lead width as measured 0.36mm (0.014 inch) or greater above the seating plane, shall not exceed a maximum value of 0.61mm (0.024 inch).
7. Controlling dimension: MILLIMETER. Converted inch dimensions are not necessarily exact.
8. This outline conforms to JEDEC publication MS-012-AA ISSUE C.

**Ceramic Dual-In-Line Frit Seal Packages (CERDIP)**



**F8.3A MIL-STD-1835 GDIP1-T8 (D-4, CONFIGURATION A)  
8 LEAD CERAMIC DUAL-IN-LINE FRIT SEAL PACKAGE**

SYMBOL	INCHES		MILLIMETERS		NOTES
	MIN	MAX	MIN	MAX	
A	-	0.200	-	5.08	-
b	0.014	0.026	0.36	0.66	2
b1	0.014	0.023	0.36	0.58	3
b2	0.045	0.065	1.14	1.65	-
b3	0.023	0.045	0.58	1.14	4
c	0.008	0.018	0.20	0.46	2
c1	0.008	0.015	0.20	0.38	3
D	-	0.405	-	10.29	5
E	0.220	0.310	5.59	7.87	5
e	0.100 BSC		2.54 BSC		-
eA	0.300 BSC		7.62 BSC		-
eA/2	0.150 BSC		3.81 BSC		-
L	0.125	0.200	3.18	5.08	-
Q	0.015	0.060	0.38	1.52	6
S1	0.005	-	0.13	-	7
α	90°	105°	90°	105°	-
aaa	-	0.015	-	0.38	-
bbb	-	0.030	-	0.76	-
ccc	-	0.010	-	0.25	-
M	-	0.0015	-	0.038	2, 3
N	8		8		8

Rev. 0 4/94

**NOTES:**

1. Index area: A notch or a pin one identification mark shall be located adjacent to pin one and shall be located within the shaded area shown. The manufacturer's identification shall not be used as a pin one identification mark.
2. The maximum limits of lead dimensions b and c or M shall be measured at the centroid of the finished lead surfaces, when solder dip or tin plate lead finish is applied.
3. Dimensions b1 and c1 apply to lead base metal only. Dimension M applies to lead plating and finish thickness.
4. Corner leads (1, N, N/2, and N/2+1) may be configured with a partial lead paddle. For this configuration dimension b3 replaces dimension b2.
5. This dimension allows for off-center lid, meniscus, and glass overrun.
6. Dimension Q shall be measured from the seating plane to the base plane.
7. Measure dimension S1 at all four corners.
8. N is the maximum number of terminal positions.
9. Dimensioning and tolerancing per ANSI Y14.5M - 1982.
10. Controlling dimension: INCH

© Copyright Intersil Americas LLC 2002-2011. All Rights Reserved.  
All trademarks and registered trademarks are the property of their respective owners.

For additional products, see [www.intersil.com/en/products.html](http://www.intersil.com/en/products.html)

Intersil products are manufactured, assembled and tested utilizing ISO9001 quality systems as noted in the quality certifications found at [www.intersil.com/en/support/qualandreliability.html](http://www.intersil.com/en/support/qualandreliability.html)

*Intersil products are sold by description only. Intersil may modify the circuit design and/or specifications of products at any time without notice, provided that such modification does not, in Intersil's sole judgment, affect the form, fit or function of the product. Accordingly, the reader is cautioned to verify that datasheets are current before placing orders. Information furnished by Intersil is believed to be accurate and reliable. However, no responsibility is assumed by Intersil or its subsidiaries for its use; nor for any infringements of patents or other rights of third parties which may result from its use. No license is granted by implication or otherwise under any patent or patent rights of Intersil or its subsidiaries.*

For information regarding Intersil Corporation and its products, see [www.intersil.com](http://www.intersil.com)

## X-ON Electronics

Largest Supplier of Electrical and Electronic Components

*Click to view similar products for [Precision Amplifiers](#) category:*

*Click to view products by [Renesas](#) manufacturer:*

Other Similar products are found below :

[561681F](#) [LT6005HGN#PBF](#) [LT6238CGN#PBF](#) [LT6238HGN#PBF](#) [OP05CN8#PBF](#) [OP227GN#PBF](#) [LT6020IDD-1#PBF](#) [LT1124CS8#TR](#)  
[NCV20166SN2T1G](#) [NCS20166SN2T1G](#) [NCS21802MUTBG](#) [LT1637MPS8](#) [LT1498IS8](#) [LT1492CS8](#) [TLC27L7CP](#) [TLV2473CDR](#)  
[LMP2234AMA/NOPB](#) [LMP7707MA/NOPB](#) [5962-8859301M2A](#) [LMP2231AMAE/NOPB](#) [LMP2234AMTE/NOPB](#) [LMC6022IM/NOPB](#)  
[LMC6024IM/NOPB](#) [LMC6081IMX/NOPB](#) [LMP2011MA/NOPB](#) [LMP2231AMFE/NOPB](#) [LMP2232BMA/NOPB](#) [LMP2234AMAE/NOPB](#)  
[LMP7717MAE/NOPB](#) [LMV2011MA/NOPB](#) [LT1013DDR](#) [TL034ACDR](#) [TLC2201AMDG4](#) [TLE2024BMDWG4](#) [TS9222IYDT](#)  
[TLV2474AQDRG4Q1](#) [TLV2472QDRQ1](#) [TLC4502IDR](#) [TLC27M2ACP](#) [TLC2652Q-8DG4](#) [OPA2107APG4](#) [TL054AIDR](#) [AD8619WARZ-](#)  
[R7](#) [TLC272CD](#) [AD8539ARMZ](#) [LTC6084HDD#PBF](#) [LT1638CMS8#TRPBF](#) [LTC1050CN8#PBF](#) [LT1112ACN8#PBF](#) [LT1996AIDD#PBF](#)