

HFA3102

Dual Long-Tailed Pair Transistor Array

FN3635  
Rev.5.00  
July 14, 2005

The HFA3102 is an all NPN transistor array configured as dual differential amplifiers with tail transistors. Based on Intersil bonded wafer UHF-1 SOI process, this array achieves very high  $f_T$  (10GHz) while maintaining excellent  $h_{FE}$  and  $V_{BE}$  matching characteristics over temperature. Collector leakage currents are maintained to under 0.01nA.

**Ordering Information**

| PART NUMBER        | TEMP. RANGE (°C) | PACKAGE                            | PKG. DWG. # |
|--------------------|------------------|------------------------------------|-------------|
| HFA3102B96         | -40 to 85        | 14 Ld SOIC Tape and Reel           | M14.15      |
| HFA3102BZ (Note)   | -40 to 85        | 14 Ld SOIC (Pb-free)               | M14.15      |
| HFA3102BZ96 (Note) | -40 to 85        | 14 Ld SOIC Tape and Reel (Pb-free) | M14.15      |

NOTE: Intersil Pb-free plus anneal products employ special Pb-free material sets; molding compounds/die attach materials and 100% matte tin plate termination finish, which are RoHS compliant and compatible with both SnPb and Pb-free soldering operations. Intersil Pb-free products are MSL classified at Pb-free peak reflow temperatures that meet or exceed the Pb-free requirements of IPC/JEDEC J STD-020.

**Pinout/Functional Diagram**

HFA3102 (SOIC)  
TOP VIEW

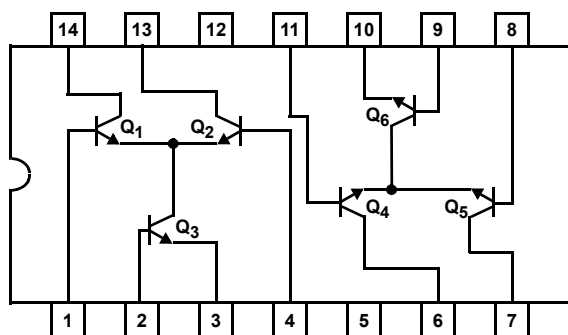

**Features**

- High Gain-Bandwidth Product ( $f_T$ ) . . . . . 10GHz
- High Power Gain-Bandwidth Product. . . . . 5GHz
- High Current Gain ( $h_{FE}$ ) . . . . . 70
- Noise Figure (Transistor) . . . . . 3.5dB
- Low Collector Leakage Current . . . . . <0.01nA
- Excellent  $h_{FE}$  and  $V_{BE}$  Matching
- Pin-to-Pin to UPA102G
- Pb-Free Plus Anneal Available (RoHS Compliant)

**Applications**

- Single Balanced Mixers
- Wide Band Amplification Stages
- Differential Amplifiers
- Multipliers
- Automatic Gain Control Circuits
- Frequency Doublers, Triplers
- Oscillators
- Constant Current Sources
- Wireless Communication Systems
- Radio and Satellite Communications
- Fiber Optic Signal Processing
- High Performance Instrumentation

**Absolute Maximum Ratings**  $T_A = 25^\circ\text{C}$ 

|  |       |
|--|-------|
| $V_{CE0}$ Collector to Emitter Voltage | 8.0V  |
| $V_{CBO}$ Collector to Base Voltage    | 12.0V |
| $V_{EBO}$ Emitter to Base Voltage      | 12.0V |
| $I_C$ , Collector Current              | 30mA  |

**Operating Conditions**

|                   |               |
|-------------------|---------------|
| Temperature Range | -40°C to 85°C |
|-------------------|---------------|

**Thermal Information**

|  |                      |
|--|----------------------|
| Thermal Resistance (Typical, Note 1)           | $\theta_{JA}$ (°C/W) |
| SOIC Package                                   | 128                  |
| Maximum Power Dissipation at 75°               |                      |
| Any One Transistor                             | 0.25W                |
| Maximum Junction Temperature (Die)             | 175°C                |
| Maximum Junction Temperature (Plastic Package) | 150°C                |
| Maximum Storage Temperature Range              | -65°C to 150°C       |
| Maximum Lead Temperature (Soldering 10s)       | 300°C                |
| (SOIC - Lead Tips Only)                        |                      |

**CAUTION:** Stresses above those listed in "Absolute Maximum Ratings" may cause permanent damage to the device. This is a stress only rating and operation of the device at these or any other conditions above those indicated in the operational sections of this specification is not implied.

## NOTE:

- $\theta_{JA}$  is measured with the component mounted on an evaluation PC board in free air.

**Electrical Specifications**  $T_A = 25^\circ\text{C}$ 

| SYMBOLS              | PARAMETER   | TEST CONDITIONS                       | (NOTE 2)<br>TEST<br>LEVEL | ALL GRADES |      |      | UNITS                        |    |
|----------------------|---|---------------------------------------|---------------------------|------------|------|------|------------------------------|----|
|                      |   |                                       |                           | MIN        | TYP  | MAX  |                              |    |
| $V_{(BR)CBO}$        | Collector-to-Base Breakdown Voltage ( $Q_1$ , $Q_2$ , $Q_4$ , and $Q_5$ ) | $I_C = 100\mu\text{A}$ , $I_E = 0$    | A                         | 12         | 18   | -    | V                            |    |
| $V_{(BR)CEO}$        | Collector-to-Emitter Breakdown Voltage ( $Q_1$ thru $Q_6$ )               | $I_C = 100\mu\text{A}$ , $I_B = 0$    | A                         | 8          | 12   | -    | V                            |    |
| $V_{(BR)EBO}$        | Emitter-to-Base Breakdown Voltage ( $Q_3$ and $Q_6$ )                     | $I_E = 50\mu\text{A}$ , $I_C = 0$     | A                         | 5.5        | 6    | -    | V                            |    |
| $I_{CBO}$            | Collector Cutoff Current ( $Q_1$ , $Q_2$ , $Q_4$ , and $Q_5$ )            | $V_{CB} = 5V$ , $I_E = 0$             | A                         | -          | 0.1  | 10   | $\mu\text{A}$                |    |
| $I_{EBO}$            | Emitter Cutoff Current ( $Q_3$ and $Q_6$ )                                | $V_{EB} = 1V$ , $I_C = 0$             | A                         | -          | -    | 100  | $\mu\text{A}$                |    |
| $h_{FE}$             | DC Current Gain ( $Q_1$ thru $Q_6$ )                                      | $I_C = 10\text{mA}$ , $V_{CE} = 3V$   | A                         | 40         | 70   | -    | -                            |    |
| $C_{CB}$             | Collector-to-Base Capacitance   | $V_{CB} = 5V$ , $f = 1\text{MHz}$     | B                         | -          | 300  | -    | $\overline{\text{fF}}$       |    |
| $C_{EB}$             | Emitter-to-Base Capacitance   | $V_{EB} = 0$ , $f = 1\text{MHz}$      | B                         | -          | 200  | -    | $\overline{\text{fF}}$       |    |
| $f_T$                | Current Gain-Bandwidth Product  | $I_C = 10\text{mA}$ , $V_{CE} = 5V$   | C                         | -          | 10   | -    | $\overline{\text{GHz}}$      |    |
| $f_{MAX}$            | Power Gain-Bandwidth Product  | $I_C = 10\text{mA}$ , $V_{CE} = 5V$   | C                         | -          | 5    | -    | GHz                          |    |
| $G_{NFMIN}$          | Available Gain at Minimum Noise Figure                                    | $I_C = 3\text{mA}$ ,<br>$V_{CE} = 3V$ | $f = 0.5\text{GHz}$       | C          | -    | 17.5 | -                            | dB |
|                      |   |                                       | $f = 1.0\text{GHz}$       | C          | -    | 12.4 | -                            | dB |
| $NF_{MIN}$           | Minimum Noise Figure  | $I_C = 3\text{mA}$ ,<br>$V_{CE} = 3V$ | $f = 0.5\text{GHz}$       | C          | -    | 1.8  | -                            | dB |
|                      |   |                                       | $f = 1.0\text{GHz}$       | C          | -    | 2.1  | -                            | dB |
| $NF_{50\Omega}$      | 50 $\Omega$ Noise Figure  | $I_C = 3\text{mA}$ ,<br>$V_{CE} = 3V$ | $f = 0.5\text{GHz}$       | C          | -    | 3.3  | -                            | dB |
|                      |   |                                       | $f = 1.0\text{GHz}$       | C          | -    | 3.5  | -                            | dB |
| $h_{FE1}/h_{FE2}$    | DC Current Gain Matching ( $Q_1$ and $Q_2$ , $Q_4$ and $Q_5$ )            | $I_C = 10\text{mA}$ , $V_{CE} = 3V$   | A                         | 0.9        | 1.0  | 1.1  | -                            |    |
| $V_{OS}$             | Input Offset Voltage ( $Q_1$ and $Q_2$ , $Q_4$ and $Q_5$ )                | $I_C = 10\text{mA}$ , $V_{CE} = 3V$   | A                         | -          | 1.5  | 5    | mV                           |    |
| $I_{OS}$             | Input Offset Current ( $Q_1$ and $Q_2$ , $Q_4$ and $Q_5$ )                | $I_C = 10\text{mA}$ , $V_{CE} = 3V$   | A                         | -          | 5    | 25   | $\mu\text{A}$                |    |
| $dV_{OS}/dT$         | Input Offset Voltage TC ( $Q_1$ and $Q_2$ , $Q_4$ and $Q_5$ )             | $I_C = 10\text{mA}$ , $V_{CE} = 3V$   | C                         | -          | 0.5  | -    | $\mu\text{V}/^\circ\text{C}$ |    |
| $I_{TRENCH-LEAKAGE}$ | Collector-to-Collector Leakage (Pin 6, 7, 13, and 14)                     | $\Delta V_{TEST} = 5V$                | B                         | -          | 0.01 | -    | nA                           |    |

## NOTE:

- Test Level: A. Production Tested; B. Typical or Guaranteed Limit Based on Characterization; C. Design Typical for Information Only

**PSpice Model for a Single Transistor**

.Model NUHFARRY NPN

+ ( IS= 1.840E-16 XTI= 3.000E+00 EG= 1.110E+00  
VAF= 7.200E+01+ VAR= 4.500E+00 BF= 1.036E+02 ISE= 1.686E-19  
NE= 1.400E+00+ IKF= 5.400E-02 XTB= 0.000E+00 BR= 1.000E+01  
ISC= 1.605E-14+ NC= 1.800E+00 IKR= 5.400E-02 RC= 1.140E+01  
CJC= 3.980E-13+ MJC= 2.400E-01 VJC= 9.700E-01 FC= 5.000E-01  
CJE= 2.400E-13+ MJE= 5.100E-01 VJE= 8.690E-01 TR= 4.000E-09  
TF= 10.51E-12+ ITF= 3.500E-02 XTF= 2.300E+00 VTF= 3.500E+00  
PTF= 0.000E+00+ XCJC= 9.000E-01 CJS= 1.689E-13 VJS= 9.982E-01  
MJS= 0.000E+00+ RE= 1.848E+00 RB= 5.007E+01 RBM= 1.974E+00  
KF= 0.000E+00

+ AF= 1.000E+00)

**Common Emitter S-Parameters****V<sub>CE</sub> = 5V and I<sub>C</sub> = 5mA**

| FREQ. (Hz) | S <sub>11</sub> | PHASE(S <sub>11</sub> ) | S <sub>12</sub> | PHASE(S <sub>12</sub> ) | S <sub>21</sub> | PHASE(S <sub>21</sub> ) | S <sub>22</sub> | PHASE(S <sub>22</sub> ) |
|------------|-----------------|-------------------------|-----------------|-------------------------|-----------------|-------------------------|-----------------|-------------------------|
| 1.0E+08    | 0.833079        | -11.7873                | 1.418901E-02    | 78.8805                 | 11.0722         | 168.576                 | 0.976833        | -11.0509                |
| 2.0E+08    | 0.791776        | -22.8290                | 2.695740E-02    | 68.6355                 | 10.5177         | 157.897                 | 0.930993        | -21.3586                |
| 3.0E+08    | 0.734911        | -32.6450                | 3.750029E-02    | 59.5861                 | 9.75379         | 148.443                 | 0.868128        | -30.4451                |
| 4.0E+08    | 0.672811        | -41.0871                | 4.572138E-02    | 51.9018                 | 8.91866         | 140.361                 | 0.799886        | -38.1641                |
| 5.0E+08    | 0.612401        | -48.2370                | 5.194147E-02    | 45.5043                 | 8.10511         | 133.569                 | 0.734033        | -44.5998                |
| 6.0E+08    | 0.557126        | -54.2780                | 5.659943E-02    | 40.2112                 | 7.35944         | 127.882                 | 0.674392        | -49.9370                |
| 7.0E+08    | 0.508133        | -59.4102                | 6.009507E-02    | 35.8226                 | 6.69712         | 123.102                 | 0.622181        | -54.3777                |
| 8.0E+08    | 0.465361        | -63.8123                | 6.274213E-02    | 32.1594                 | 6.11750         | 119.047                 | 0.577269        | -58.1022                |
| 9.0E+08    | 0.428238        | -67.6313                | 6.477134E-02    | 29.0743                 | 5.61303         | 115.571                 | 0.538952        | -61.2587                |
| 1.0E+09    | 0.396034        | -70.9834                | 6.634791E-02    | 26.4506                 | 5.17405         | 112.556                 | 0.506365        | -63.9647                |
| 1.1E+09    | 0.368032        | -73.9591                | 6.758932E-02    | 24.1974                 | 4.79104         | 109.913                 | 0.478663        | -66.3116                |
| 1.2E+09    | 0.343589        | -76.6285                | 6.857937E-02    | 22.2441                 | 4.45546         | 107.570                 | 0.455091        | -68.3702                |
| 1.3E+09    | 0.322155        | -79.0462                | 6.937837E-02    | 20.5358                 | 4.15997         | 105.472                 | 0.435008        | -70.1958                |
| 1.4E+09    | 0.303268        | -81.2548                | 7.003020E-02    | 19.0293                 | 3.89845         | 103.576                 | 0.417872        | -71.8314                |
| 1.5E+09    | 0.286542        | -83.2880                | 7.056718E-02    | 17.6908                 | 3.66577         | 101.849                 | 0.403238        | -73.3108                |
| 1.6E+09    | 0.271660        | -85.1723                | 7.101343E-02    | 16.4930                 | 3.45770         | 100.262                 | 0.390735        | -74.6609                |
| 1.7E+09    | 0.258359        | -86.9292                | 7.138717E-02    | 15.4143                 | 3.27074         | 98.7956                 | 0.380056        | -75.9030                |
| 1.8E+09    | 0.246420        | -88.5759                | 7.170231E-02    | 14.4370                 | 3.10197         | 97.4307                 | 0.370947        | -77.0544                |
| 1.9E+09    | 0.235659        | -90.1265                | 7.196964E-02    | 13.5469                 | 2.94897         | 96.1533                 | 0.363195        | -78.1288                |
| 2.0E+09    | 0.225923        | -91.5925                | 7.219757E-02    | 12.7319                 | 2.80969         | 94.9515                 | 0.356623        | -79.1377                |
| 2.1E+09    | 0.217085        | -92.9836                | 7.239274E-02    | 11.9824                 | 2.68243         | 93.8156                 | 0.351081        | -80.0903                |
| 2.2E+09    | 0.209034        | -94.3076                | 7.256046E-02    | 11.2901                 | 2.56573         | 92.7373                 | 0.346442        | -80.9942                |
| 2.3E+09    | 0.201678        | -95.5713                | 7.270498E-02    | 10.6480                 | 2.45837         | 91.7097                 | 0.342599        | -81.8557                |
| 2.4E+09    | 0.194939        | -96.7803                | 7.282977E-02    | 10.0503                 | 2.35928         | 90.7271                 | 0.339458        | -82.6802                |
| 2.5E+09    | 0.188747        | -97.9395                | 7.293764E-02    | 9.49212                 | 2.26756         | 89.7844                 | 0.336942        | -83.4719                |
| 2.6E+09    | 0.183044        | -99.0530                | 7.303093E-02    | 8.96908                 | 2.18243         | 88.8775                 | 0.334982        | -84.2347                |
| 2.7E+09    | 0.177780        | -100.124                | 7.311157E-02    | 8.47753                 | 2.10322         | 88.0026                 | 0.333518        | -84.9716                |
| 2.8E+09    | 0.172909        | -101.156                | 7.318117E-02    | 8.01430                 | 2.02934         | 87.1565                 | 0.332499        | -85.6853                |
| 2.9E+09    | 0.168394        | -102.152                | 7.324107E-02    | 7.57661                 | 1.96027         | 86.3366                 | 0.331879        | -86.3781                |
| 3.0E+09    | 0.164200        | -103.114                | 7.329243E-02    | 7.16204                 | 1.89556         | 85.5404                 | 0.331620        | -87.0518                |

**V<sub>CE</sub> = 5V and I<sub>C</sub> = 10mA**

| FREQ. (Hz) | S <sub>11</sub> | PHASE(S <sub>11</sub> ) | S <sub>12</sub> | PHASE(S <sub>12</sub> ) | S <sub>21</sub> | PHASE(S <sub>21</sub> ) | S <sub>22</sub> | PHASE(S <sub>22</sub> ) |
|------------|-----------------|-------------------------|-----------------|-------------------------|-----------------|-------------------------|-----------------|-------------------------|
| 1.0E+08    | 0.728106        | -16.4319                | 1.273920E-02    | 75.4177                 | 15.1273         | 165.227                 | 0.959692        | -14.2688                |
| 2.0E+08    | 0.670836        | -31.2669                | 2.342300E-02    | 62.8941                 | 13.9061         | 152.045                 | 0.886232        | -26.9507                |
| 3.0E+08    | 0.600268        | -43.7663                | 3.132521E-02    | 52.5891                 | 12.3970         | 141.185                 | 0.796016        | -37.3172                |
| 4.0E+08    | 0.531768        | -54.0028                | 3.681579E-02    | 44.5019                 | 10.9257         | 132.570                 | 0.708892        | -45.4503                |
| 5.0E+08    | 0.471795        | -62.3880                | 4.057046E-02    | 38.2308                 | 9.62995         | 125.781                 | 0.633146        | -51.7704                |
| 6.0E+08    | 0.421506        | -69.3569                | 4.316292E-02    | 33.3405                 | 8.53559         | 120.378                 | 0.570209        | -56.7206                |
| 7.0E+08    | 0.379961        | -75.2612                | 4.499071E-02    | 29.4764                 | 7.62375         | 116.005                 | 0.518803        | -60.6598                |
| 8.0E+08    | 0.345693        | -80.3608                | 4.631140E-02    | 26.3755                 | 6.86423         | 112.398                 | 0.476987        | -63.8540                |
| 9.0E+08    | 0.317301        | -84.8420                | 4.728948E-02    | 23.8481                 | 6.22797         | 109.365                 | 0.442915        | -66.4948                |
| 1.0E+09    | 0.293608        | -88.8381                | 4.803091E-02    | 21.7581                 | 5.69057         | 106.771                 | 0.415044        | -68.7193                |
| 1.1E+09    | 0.273680        | -92.4452                | 4.860515E-02    | 20.0070                 | 5.23257         | 104.518                 | 0.392146        | -70.6269                |
| 1.2E+09    | 0.256782        | -95.7336                | 4.905871E-02    | 18.5224                 | 4.83873         | 102.532                 | 0.373261        | -72.2899                |
| 1.3E+09    | 0.242344        | -98.7555                | 4.942344E-02    | 17.2505                 | 4.49716         | 100.759                 | 0.357640        | -73.7620                |
| 1.4E+09    | 0.229918        | -101.551                | 4.972158E-02    | 16.1506                 | 4.19854         | 99.1602                 | 0.344698        | -75.0832                |
| 1.5E+09    | 0.219152        | -104.150                | 4.996903E-02    | 15.1915                 | 3.93554         | 97.7028                 | 0.333974        | -76.2840                |
| 1.6E+09    | 0.209767        | -106.577                | 5.017730E-02    | 14.3490                 | 3.70234         | 96.3629                 | 0.325102        | -77.3877                |
| 1.7E+09    | 0.201539        | -108.851                | 5.035491E-02    | 13.6040                 | 3.49428         | 95.1215                 | 0.317789        | -78.4122                |
| 1.8E+09    | 0.194288        | -110.988                | 5.050825E-02    | 12.9411                 | 3.30758         | 93.9633                 | 0.311800        | -79.3715                |
| 1.9E+09    | 0.187867        | -113.001                | 5.064218E-02    | 12.3482                 | 3.13919         | 92.8761                 | 0.306940        | -80.2768                |
| 2.0E+09    | 0.182157        | -114.902                | 5.076045E-02    | 11.8151                 | 2.98658         | 91.8500                 | 0.303051        | -81.1365                |
| 2.1E+09    | 0.177056        | -116.698                | 5.086598E-02    | 11.3338                 | 2.84766         | 90.8766                 | 0.300003        | -81.9578                |
| 2.2E+09    | 0.172484        | -118.399                | 5.096107E-02    | 10.8974                 | 2.72068         | 89.9494                 | 0.297686        | -82.7460                |
| 2.3E+09    | 0.168370        | -120.012                | 5.104755E-02    | 10.5001                 | 2.60420         | 89.0626                 | 0.296007        | -83.5057                |
| 2.4E+09    | 0.164656        | -121.542                | 5.112690E-02    | 10.1373                 | 2.49697         | 88.2115                 | 0.294889        | -84.2405                |
| 2.5E+09    | 0.161293        | -122.996                | 5.120031E-02    | 9.80479                 | 2.39793         | 87.3920                 | 0.294266        | -84.9533                |
| 2.6E+09    | 0.158239        | -124.378                | 5.126876E-02    | 9.49919                 | 2.30619         | 86.6007                 | 0.294081        | -85.6466                |
| 2.7E+09    | 0.155458        | -125.694                | 5.133304E-02    | 9.21750                 | 2.22098         | 85.8348                 | 0.294285        | -86.3223                |
| 2.8E+09    | 0.152919        | -126.947                | 5.139381E-02    | 8.95716                 | 2.14162         | 85.0916                 | 0.294836        | -86.9822                |
| 2.9E+09    | 0.150595        | -128.140                | 5.145164E-02    | 8.71595                 | 2.06753         | 84.3690                 | 0.295696        | -87.6275                |
| 3.0E+09    | 0.148463        | -129.279                | 5.150697E-02    | 8.49194                 | 1.99820         | 83.6651                 | 0.296834        | -88.2595                |

**Typical Performance Curves**

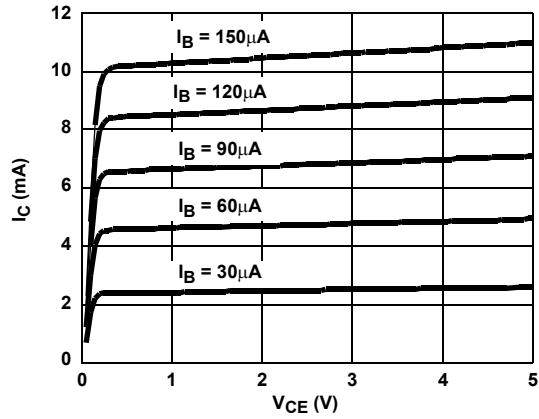

FIGURE 1.  $I_C$  vs  $V_{CE}$

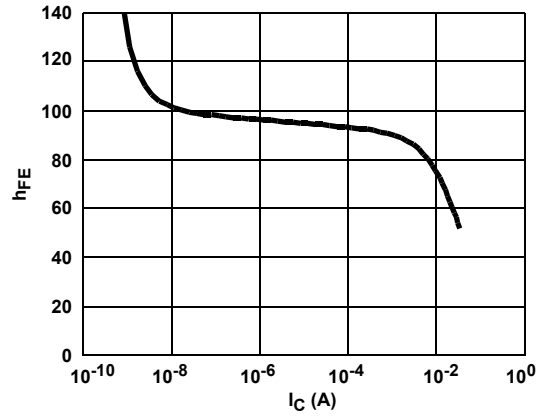

FIGURE 2.  $h_{FE}$  vs  $I_C$

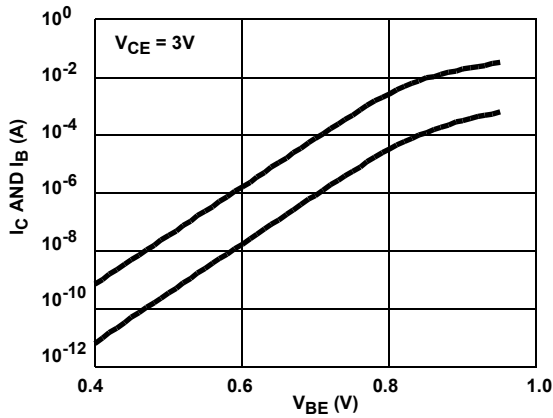

FIGURE 3. GUMMEL PLOT

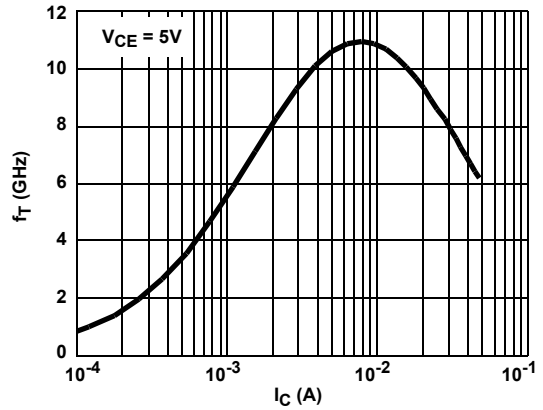

FIGURE 4.  $f_T$  vs  $I_C$

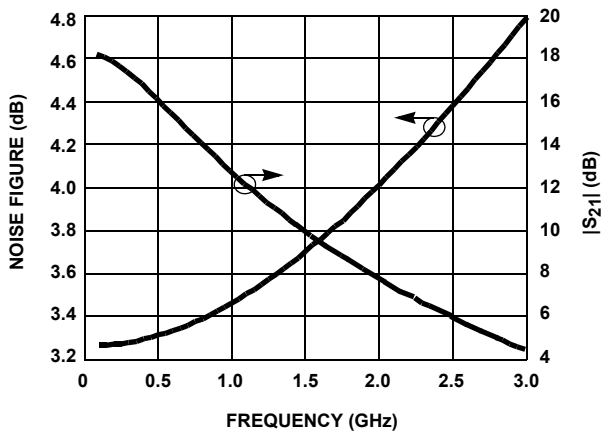

FIGURE 5. GAIN AND NOISE FIGURE vs FREQUENCY

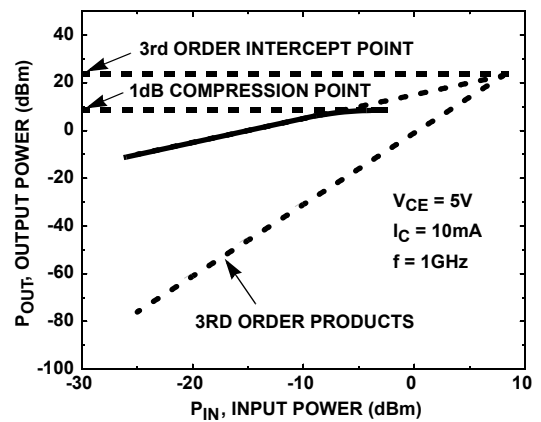

FIGURE 6.  $P_{1dB}$  AND 3RD ORDER INTERCEPT

**Die Characteristics**

**PROCESS:**

UHF-1

**DIE DIMENSIONS:**

53 mils x 52 mils x 14 mils  
 1340 $\mu$ m x 1320 $\mu$ m x 355.6 $\mu$ m

**METALLIZATION:**

Type: Metal 1: AlCu(2%)/TiW  
 Thickness: Metal 1: 8k $\text{\AA}$   $\pm$ 0.5k $\text{\AA}$   
 Type: Metal 2: AlCu(2%)  
 Thickness: Metal 2: 16k $\text{\AA}$   $\pm$ 0.8k $\text{\AA}$

**PASSIVATION:**

Type: Nitride  
 Thickness: 4k $\text{\AA}$   $\pm$ 0.5k $\text{\AA}$

**SUBSTRATE POTENTIAL (POWERED UP):**

Floating

**Metallization Mask Layout**

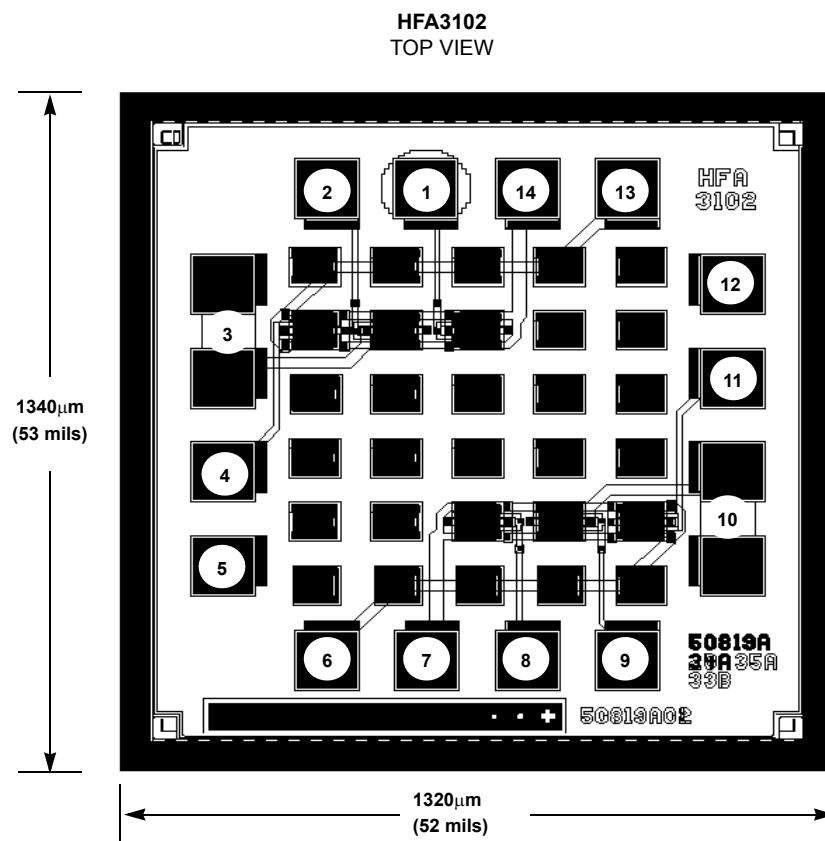

Pad numbers correspond to the 14 pin SOIC pinout.

**Small Outline Plastic Packages (SOIC)**

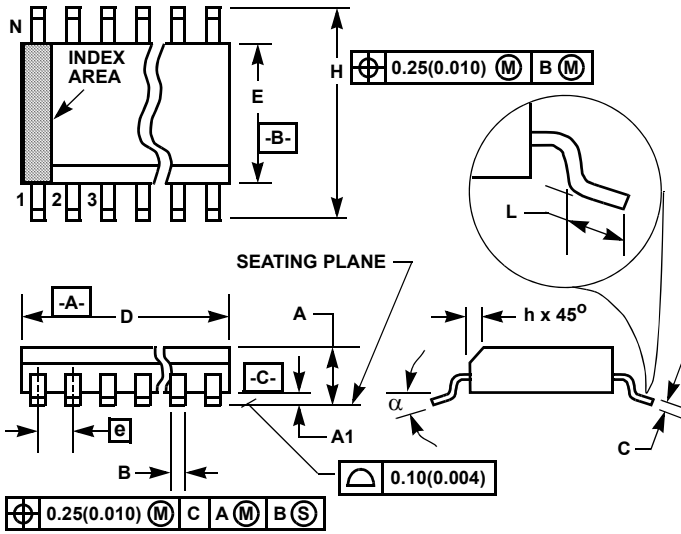

**M14.15 (JEDEC MS-012-AB ISSUE C)  
14 LEAD NARROW BODY SMALL OUTLINE PLASTIC PACKAGE**

| SYMBOL | INCHES    |        | MILLIMETERS |      | NOTES |
|--------|-----------|--------|-------------|------|-------|
|        | MIN       | MAX    | MIN         | MAX  |       |
| A      | 0.0532    | 0.0688 | 1.35        | 1.75 | -     |
| A1     | 0.0040    | 0.0098 | 0.10        | 0.25 | -     |
| B      | 0.013     | 0.020  | 0.33        | 0.51 | 9     |
| C      | 0.0075    | 0.0098 | 0.19        | 0.25 | -     |
| D      | 0.3367    | 0.3444 | 8.55        | 8.75 | 3     |
| E      | 0.1497    | 0.1574 | 3.80        | 4.00 | 4     |
| e      | 0.050 BSC |        | 1.27 BSC    |      | -     |
| H      | 0.2284    | 0.2440 | 5.80        | 6.20 | -     |
| h      | 0.0099    | 0.0196 | 0.25        | 0.50 | 5     |
| L      | 0.016     | 0.050  | 0.40        | 1.27 | 6     |
| N      | 14        |        | 14          |      | 7     |
| α      | 0°        | 8°     | 0°          | 8°   | -     |

**NOTES:**

1. Symbols are defined in the "MO Series Symbol List" in Section 2.2 of Publication Number 95.
2. Dimensioning and tolerancing per ANSI Y14.5M-1982.
3. Dimension "D" does not include mold flash, protrusions or gate burrs. Mold flash, protrusion and gate burrs shall not exceed 0.15mm (0.006 inch) per side.
4. Dimension "E" does not include interlead flash or protrusions. Interlead flash and protrusions shall not exceed 0.25mm (0.010 inch) per side.
5. The chamfer on the body is optional. If it is not present, a visual index feature must be located within the crosshatched area.
6. "L" is the length of terminal for soldering to a substrate.
7. "N" is the number of terminal positions.
8. Terminal numbers are shown for reference only.
9. The lead width "B", as measured 0.36mm (0.014 inch) or greater above the seating plane, shall not exceed a maximum value of 0.61mm (0.024 inch).
10. Controlling dimension: MILLIMETER. Converted inch dimensions are not necessarily exact.

Rev. 0 12/93

© Copyright Intersil Americas LLC 2003-2005. All Rights Reserved.  
All trademarks and registered trademarks are the property of their respective owners.

For additional products, see [www.intersil.com/en/products.html](http://www.intersil.com/en/products.html)

Intersil products are manufactured, assembled and tested utilizing ISO9001 quality systems as noted in the quality certifications found at [www.intersil.com/en/support/qualandreliability.html](http://www.intersil.com/en/support/qualandreliability.html)

*Intersil products are sold by description only. Intersil may modify the circuit design and/or specifications of products at any time without notice, provided that such modification does not, in Intersil's sole judgment, affect the form, fit or function of the product. Accordingly, the reader is cautioned to verify that datasheets are current before placing orders. Information furnished by Intersil is believed to be accurate and reliable. However, no responsibility is assumed by Intersil or its subsidiaries for its use; nor for any infringements of patents or other rights of third parties which may result from its use. No license is granted by implication or otherwise under any patent or patent rights of Intersil or its subsidiaries.*

For information regarding Intersil Corporation and its products, see [www.intersil.com](http://www.intersil.com)

## X-ON Electronics

Largest Supplier of Electrical and Electronic Components

*Click to view similar products for [RF Bipolar Transistors](#) category:*

*Click to view products by [Renesas](#) manufacturer:*

Other Similar products are found below :

[MAPRST0912-50](#) [MCH4016-TL-H](#) [MMBT5551-G](#) [MRF10120](#) [15GN01CA-TB-E](#) [PH1214-25M](#) [MAPRST0912-350](#) [MMBTH10-TP](#) [BFP640F H6327](#) [BFP 720F H6327](#) [BFP 740F H6327](#) [BFR 360F H6765](#) [MRF10031](#) [NSVF4009SG4T1G](#) [BFP 182R E7764](#) [BFP405H6740XTSA1](#) [MRF10350](#) [BFR360FH6765XTSA1](#) [BFP410H6327XTSA1](#) [BFP620FH7764XTSA1](#) [BFP720ESDH6327XTSA1](#) [BFP720FH6327XTSA1](#) [BFR360L3E6765XTMA1](#) [BFP420H6433XTMA1](#) [BFP420H6740XTSA1](#) [BFP420H6801XTSA1](#) [MCH4015-TL-H](#) [BF888H6327XTSA1](#) [MMBT2222A-G](#) [BFP196WH6327XTSA1](#) [BFP405FH6327XTSA1](#) [BFP640ESDH6327XTSA1](#) [BFR193L3E6327XTMA1](#) [BFS483H6327XTSA1](#) [NSVF4020SG4T1G](#) [NSVF6003SB6T1G](#) [MRF10005](#) [BFP420FH6327XTSA1](#) [BFP740FESDH6327XTSA1](#) [BFR181E6327HTSA1](#) [BFR181WH6327XTSA1](#) [BFR182E6327HTSA1](#) [BFR193E6327HTSA1](#) [BFP181E7764HTSA1](#) [BFP183WH6327XTSA1](#) [BFP720H6327XTSA1](#) [BFR182WH6327XTSA1](#) [BFU590GX](#) [MAPR-000912-500S00](#) [BFR340FH6327XTSA1](#)