

To our customers,

---

## Old Company Name in Catalogs and Other Documents

---

On April 1<sup>st</sup>, 2010, NEC Electronics Corporation merged with Renesas Technology Corporation, and Renesas Electronics Corporation took over all the business of both companies. Therefore, although the old company name remains in this document, it is a valid Renesas Electronics document. We appreciate your understanding.

Renesas Electronics website: <http://www.renesas.com>

April 1<sup>st</sup>, 2010  
Renesas Electronics Corporation

Issued by: Renesas Electronics Corporation (<http://www.renesas.com>)

Send any inquiries to <http://www.renesas.com/inquiry>.

## Notice

1. All information included in this document is current as of the date this document is issued. Such information, however, is subject to change without any prior notice. Before purchasing or using any Renesas Electronics products listed herein, please confirm the latest product information with a Renesas Electronics sales office. Also, please pay regular and careful attention to additional and different information to be disclosed by Renesas Electronics such as that disclosed through our website.
2. Renesas Electronics does not assume any liability for infringement of patents, copyrights, or other intellectual property rights of third parties by or arising from the use of Renesas Electronics products or technical information described in this document. No license, express, implied or otherwise, is granted hereby under any patents, copyrights or other intellectual property rights of Renesas Electronics or others.
3. You should not alter, modify, copy, or otherwise misappropriate any Renesas Electronics product, whether in whole or in part.
4. Descriptions of circuits, software and other related information in this document are provided only to illustrate the operation of semiconductor products and application examples. You are fully responsible for the incorporation of these circuits, software, and information in the design of your equipment. Renesas Electronics assumes no responsibility for any losses incurred by you or third parties arising from the use of these circuits, software, or information.
5. When exporting the products or technology described in this document, you should comply with the applicable export control laws and regulations and follow the procedures required by such laws and regulations. You should not use Renesas Electronics products or the technology described in this document for any purpose relating to military applications or use by the military, including but not limited to the development of weapons of mass destruction. Renesas Electronics products and technology may not be used for or incorporated into any products or systems whose manufacture, use, or sale is prohibited under any applicable domestic or foreign laws or regulations.
6. Renesas Electronics has used reasonable care in preparing the information included in this document, but Renesas Electronics does not warrant that such information is error free. Renesas Electronics assumes no liability whatsoever for any damages incurred by you resulting from errors in or omissions from the information included herein.
7. Renesas Electronics products are classified according to the following three quality grades: “Standard”, “High Quality”, and “Specific”. The recommended applications for each Renesas Electronics product depends on the product’s quality grade, as indicated below. You must check the quality grade of each Renesas Electronics product before using it in a particular application. You may not use any Renesas Electronics product for any application categorized as “Specific” without the prior written consent of Renesas Electronics. Further, you may not use any Renesas Electronics product for any application for which it is not intended without the prior written consent of Renesas Electronics. Renesas Electronics shall not be in any way liable for any damages or losses incurred by you or third parties arising from the use of any Renesas Electronics product for an application categorized as “Specific” or for which the product is not intended where you have failed to obtain the prior written consent of Renesas Electronics. The quality grade of each Renesas Electronics product is “Standard” unless otherwise expressly specified in a Renesas Electronics data sheets or data books, etc.
  - “Standard”: Computers; office equipment; communications equipment; test and measurement equipment; audio and visual equipment; home electronic appliances; machine tools; personal electronic equipment; and industrial robots.
  - “High Quality”: Transportation equipment (automobiles, trains, ships, etc.); traffic control systems; anti-disaster systems; anti-crime systems; safety equipment; and medical equipment not specifically designed for life support.
  - “Specific”: Aircraft; aerospace equipment; submersible repeaters; nuclear reactor control systems; medical equipment or systems for life support (e.g. artificial life support devices or systems), surgical implantations, or healthcare intervention (e.g. excision, etc.), and any other applications or purposes that pose a direct threat to human life.
8. You should use the Renesas Electronics products described in this document within the range specified by Renesas Electronics, especially with respect to the maximum rating, operating supply voltage range, movement power voltage range, heat radiation characteristics, installation and other product characteristics. Renesas Electronics shall have no liability for malfunctions or damages arising out of the use of Renesas Electronics products beyond such specified ranges.
9. Although Renesas Electronics endeavors to improve the quality and reliability of its products, semiconductor products have specific characteristics such as the occurrence of failure at a certain rate and malfunctions under certain use conditions. Further, Renesas Electronics products are not subject to radiation resistance design. Please be sure to implement safety measures to guard them against the possibility of physical injury, and injury or damage caused by fire in the event of the failure of a Renesas Electronics product, such as safety design for hardware and software including but not limited to redundancy, fire control and malfunction prevention, appropriate treatment for aging degradation or any other appropriate measures. Because the evaluation of microcomputer software alone is very difficult, please evaluate the safety of the final products or system manufactured by you.
10. Please contact a Renesas Electronics sales office for details as to environmental matters such as the environmental compatibility of each Renesas Electronics product. Please use Renesas Electronics products in compliance with all applicable laws and regulations that regulate the inclusion or use of controlled substances, including without limitation, the EU RoHS Directive. Renesas Electronics assumes no liability for damages or losses occurring as a result of your noncompliance with applicable laws and regulations.
11. This document may not be reproduced or duplicated, in any form, in whole or in part, without prior written consent of Renesas Electronics.
12. Please contact a Renesas Electronics sales office if you have any questions regarding the information contained in this document or Renesas Electronics products, or if you have any other inquiries.

(Note 1) “Renesas Electronics” as used in this document means Renesas Electronics Corporation and also includes its majority-owned subsidiaries.

(Note 2) “Renesas Electronics product(s)” means any product developed or manufactured by or for Renesas Electronics.

To all our customers

---

## **Regarding the change of names mentioned in the document, such as Hitachi Electric and Hitachi XX, to Renesas Technology Corp.**

---

The semiconductor operations of Mitsubishi Electric and Hitachi were transferred to Renesas Technology Corporation on April 1st 2003. These operations include microcomputer, logic, analog and discrete devices, and memory chips other than DRAMs (flash memory, SRAMs etc.) Accordingly, although Hitachi, Hitachi, Ltd., Hitachi Semiconductors, and other Hitachi brand names are mentioned in the document, these names have in fact all been changed to Renesas Technology Corp. Thank you for your understanding. Except for our corporate trademark, logo and corporate statement, no changes whatsoever have been made to the contents of the document, and these changes do not constitute any alteration to the contents of the document itself.

Renesas Technology Home Page: <http://www.renesas.com>

Renesas Technology Corp.  
Customer Support Dept.  
April 1, 2003

## Cautions

Keep safety first in your circuit designs!

1. Renesas Technology Corporation puts the maximum effort into making semiconductor products better and more reliable, but there is always the possibility that trouble may occur with them. Trouble with semiconductors may lead to personal injury, fire or property damage.  
Remember to give due consideration to safety when making your circuit designs, with appropriate measures such as (i) placement of substitutive, auxiliary circuits, (ii) use of nonflammable material or (iii) prevention against any malfunction or mishap.

Notes regarding these materials

1. These materials are intended as a reference to assist our customers in the selection of the Renesas Technology Corporation product best suited to the customer's application; they do not convey any license under any intellectual property rights, or any other rights, belonging to Renesas Technology Corporation or a third party.
2. Renesas Technology Corporation assumes no responsibility for any damage, or infringement of any third-party's rights, originating in the use of any product data, diagrams, charts, programs, algorithms, or circuit application examples contained in these materials.
3. All information contained in these materials, including product data, diagrams, charts, programs and algorithms represents information on products at the time of publication of these materials, and are subject to change by Renesas Technology Corporation without notice due to product improvements or other reasons. It is therefore recommended that customers contact Renesas Technology Corporation or an authorized Renesas Technology Corporation product distributor for the latest product information before purchasing a product listed herein.  
The information described here may contain technical inaccuracies or typographical errors. Renesas Technology Corporation assumes no responsibility for any damage, liability, or other loss rising from these inaccuracies or errors.  
Please also pay attention to information published by Renesas Technology Corporation by various means, including the Renesas Technology Corporation Semiconductor home page (<http://www.renesas.com>).
4. When using any or all of the information contained in these materials, including product data, diagrams, charts, programs, and algorithms, please be sure to evaluate all information as a total system before making a final decision on the applicability of the information and products. Renesas Technology Corporation assumes no responsibility for any damage, liability or other loss resulting from the information contained herein.
5. Renesas Technology Corporation semiconductors are not designed or manufactured for use in a device or system that is used under circumstances in which human life is potentially at stake. Please contact Renesas Technology Corporation or an authorized Renesas Technology Corporation product distributor when considering the use of a product contained herein for any specific purposes, such as apparatus or systems for transportation, vehicular, medical, aerospace, nuclear, or undersea repeater use.
6. The prior written approval of Renesas Technology Corporation is necessary to reprint or reproduce in whole or in part these materials.
7. If these products or technologies are subject to the Japanese export control restrictions, they must be exported under a license from the Japanese government and cannot be imported into a country other than the approved destination.  
Any diversion or reexport contrary to the export control laws and regulations of Japan and/or the country of destination is prohibited.
8. Please contact Renesas Technology Corporation for further details on these materials or the products contained therein.

---

# HM6216514I Series

Wide Temperature Range Version  
8 M SRAM (512-kword × 16-bit)



ADE-203-1303B (Z)  
Rev. 1.0  
Oct. 23, 2002

---

## Description

The Hitachi HM6216514I Series is 8-Mbit static RAM organized 524,288-word × 16-bit. HM6216514I Series has realized higher density, higher performance and low power consumption by employing CMOS process technology (6-transistor memory cell). It offers low power standby power dissipation; therefore, it is suitable for battery backup systems. It is packaged in standard 44-pin plastic TSOPII.

## Features

- Single 5.0 V supply: 5.0V ± 10 %
- Fast access time: 55 ns (Max)
- Power dissipation:
  - Active: 10 mW/MHz (Typ)
  - Standby: 7.5 μW (Typ)
- Completely static memory.
  - No clock or timing strobe required
- Equal access and cycle times
- Common data input and output.
  - Three state output
- Battery backup operation.
- Temperature range: -40 to +85°C

---

## HM6216514I Series

---

### Ordering Information

Type No.	Access time	Package
HM6216514LTTI-5SL	55 ns	400-mil 44-pin plastic TSOPII (normal-bend type) (TTP-44DE)

---

## Pin Arrangement

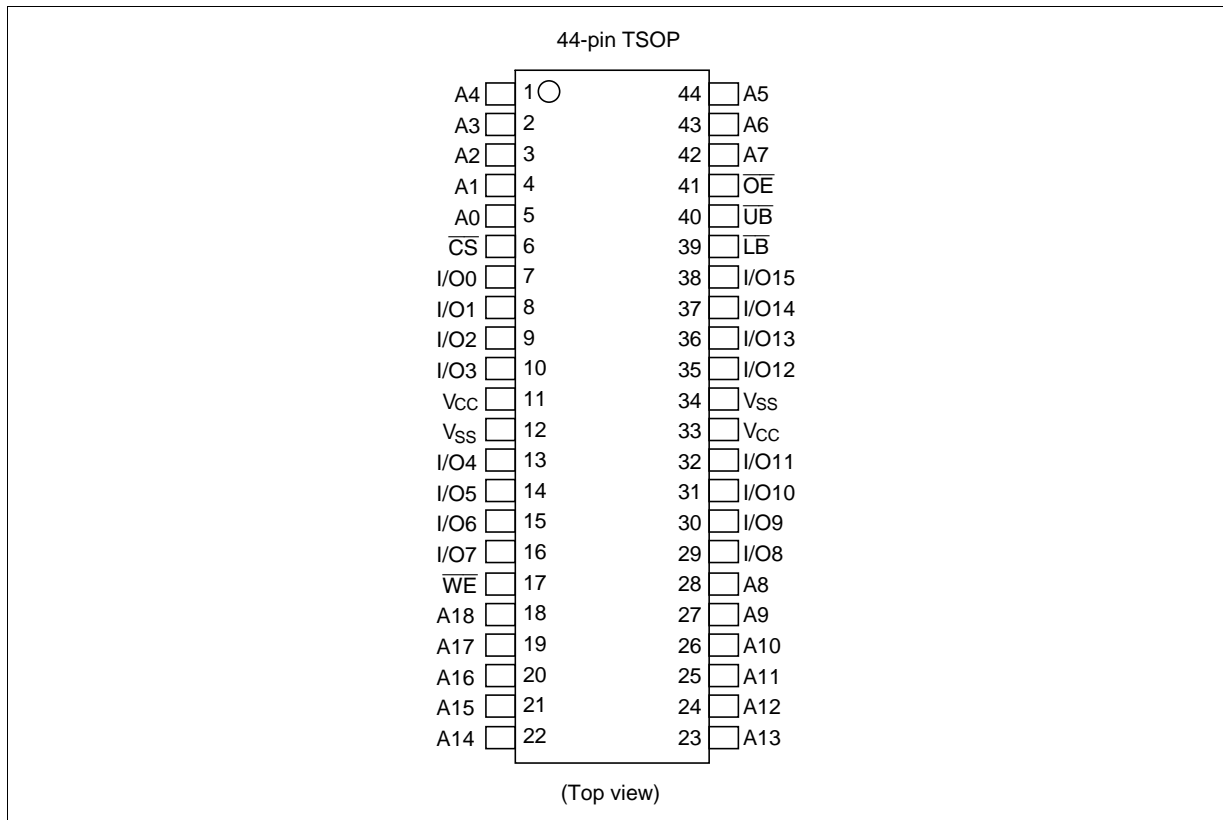

## Pin Description

Pin name	Function
A0 to A18	Address input
I/O0 to I/O15	Data input/output
$\overline{\text{CS}}$	Chip select
$\overline{\text{WE}}$	Write enable
$\overline{\text{OE}}$	Output enable
$\overline{\text{LB}}$	Lower byte select
$\overline{\text{UB}}$	Upper byte select
V <sub>cc</sub>	Power supply
V <sub>ss</sub>	Ground

# HM6216514I Series

## Block Diagram

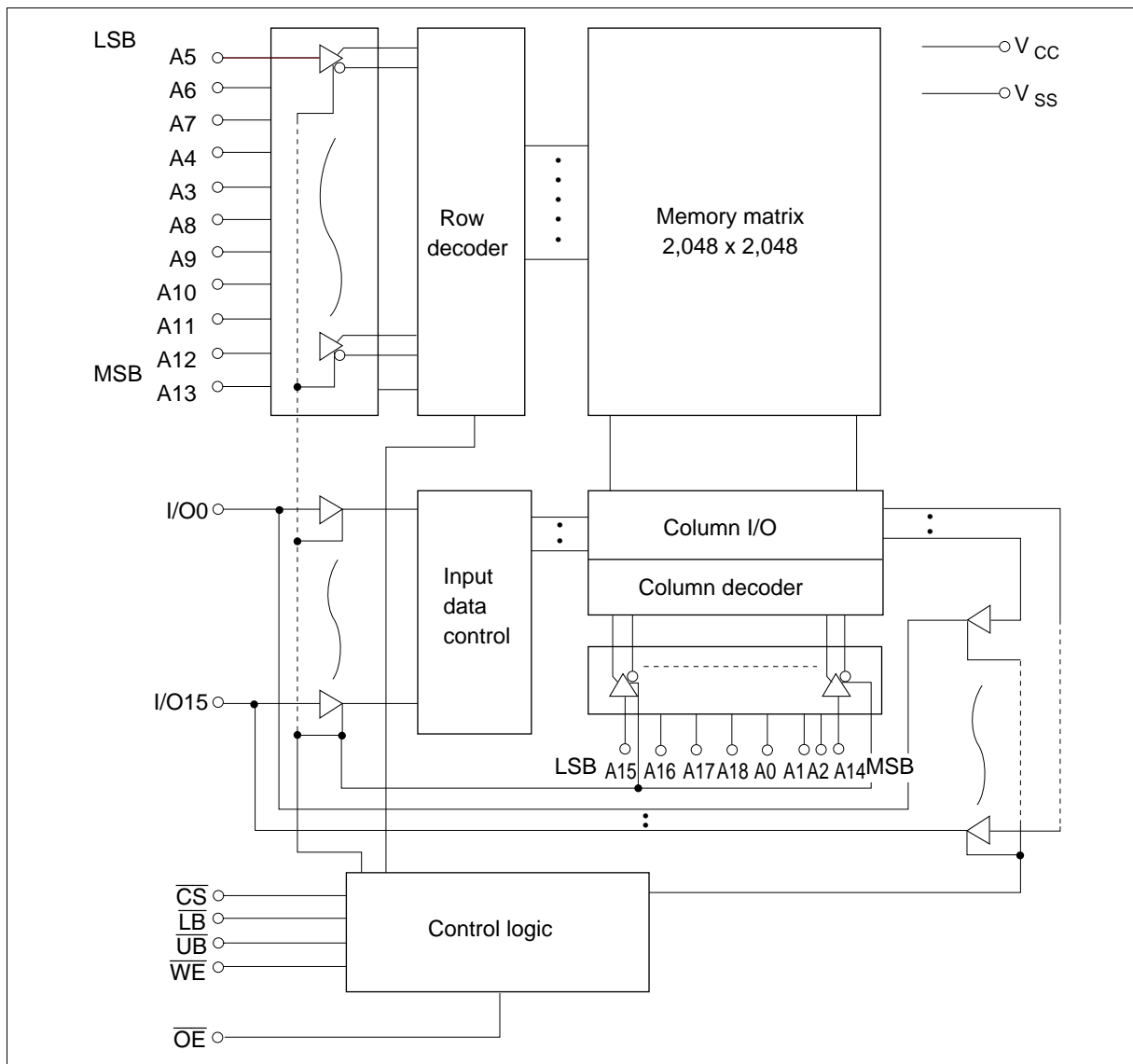



**Operation Table**

$\overline{CS}$	$\overline{WE}$	$\overline{OE}$	$\overline{UB}$	$\overline{LB}$	I/O0 to I/O7	I/O8 to I/O15	Operation
H	×	×	×	×	High-Z	High-Z	Standby
×	×	×	H	H	High-Z	High-Z	Standby
L	H	L	L	L	Dout	Dout	Read
L	H	L	H	L	Dout	High-Z	Lower byte read
L	H	L	L	H	High-Z	Dout	Upper byte read
L	L	×	L	L	Din	Din	Write
L	L	×	H	L	Din	High-Z	Lower byte write
L	L	×	L	H	High-Z	Din	Upper byte write
L	H	H	×	×	High-Z	High-Z	Output disable

Note: H:  $V_{IH}$ , L:  $V_{IL}$ , ×:  $V_{IH}$  or  $V_{IL}$

**Absolute Maximum Ratings**

Parameter	Symbol	Value	Unit
Power supply voltage relative to $V_{SS}$	$V_{CC}$	-0.5 to +7.0	V
Terminal voltage on any pin relative to $V_{SS}$	$V_T$	-0.5* <sup>1</sup> to $V_{CC} + 0.3$ * <sup>2</sup>	V
Power dissipation	$P_T$	1.0	W
Storage temperature range	Tstg	-55 to +125	°C
Storage temperature range under bias	Tbias	-40 to +85	°C

Notes: 1.  $V_T$  min: -3.0 V for pulse half-width ≤ 30 ns.

2. Maximum voltage is +7.0 V.

**DC Operating Conditions**

Parameter	Symbol	Min	Typ	Max	Unit	Note
Supply voltage	$V_{CC}$	4.5	5.0	5.5	V	
	$V_{SS}$	0	0	0	V	
Input high voltage	$V_{IH}$	2.2	—	$V_{CC} + 0.3$	V	
Input low voltage	$V_{IL}$	-0.3	—	0.8	V	1
Ambient temperature range	Ta	-40	—	85	°C	

Note: 1.  $V_{IL}$  min: -3.0 V for pulse half-width ≤ 30 ns.

## HM6216514I Series

### DC Characteristics

Parameter	Symbol	Min	Typ*1	Max	Unit	Test conditions
Input leakage current	$ I_{L1} $	—	—	1	$\mu\text{A}$	$V_{in} = V_{SS} \text{ to } V_{CC}$
Output leakage current	$ I_{LO} $	—	—	1	$\mu\text{A}$	$\overline{CS} = V_{IH}$ or $\overline{OE} = V_{IH}$ or $\overline{WE} = V_{IL}$ or $\overline{LB} = \overline{UB} = V_{IH}$ , $V_{I/O} = V_{SS} \text{ to } V_{CC}$
Operating current	$I_{CC}$	—	—	20	mA	$\overline{CS} = V_{IL}$ , Others = $V_{IH}/V_{IL}$ , $I_{I/O} = 0 \text{ mA}$
Average operating current	$I_{CC1}$	—	16	35	mA	Min. cycle, duty = 100%, $I_{I/O} = 0 \text{ mA}$ , $\overline{CS} = V_{IL}$ , Others = $V_{IH}/V_{IL}$
	$I_{CC2}$	—	2	5	mA	Cycle time = 1 $\mu\text{s}$ , duty = 100%, $I_{I/O} = 0 \text{ mA}$ , $\overline{CS} \leq 0.2 \text{ V}$ , $V_{IH} \geq V_{CC} - 0.2 \text{ V}$ , $V_{IL} \leq 0.2 \text{ V}$
Standby current	$I_{SB}$	—	0.1	0.3	mA	$\overline{CS} = V_{IH}$
Standby current	$I_{SB1}$	—	0.8	10	$\mu\text{A}$	$0 \text{ V} \leq V_{in}$ (1) $\overline{CS} \geq V_{CC} - 0.2 \text{ V}$ or (2) $\overline{LB} = \overline{UB} \geq V_{CC} - 0.2 \text{ V}$ , $\overline{CS} \leq 0.2 \text{ V}$
Output high voltage	$V_{OH}$	2.4	—	—	V	$I_{OH} = -1 \text{ mA}$
Output low voltage	$V_{OL}$	—	—	0.4	V	$I_{OL} = 2.1 \text{ mA}$

Notes: 1. Typical values are at  $V_{CC} = 5.0 \text{ V}$ ,  $T_a = +25^\circ\text{C}$  and not guaranteed.

### Capacitance ( $T_a = +25^\circ\text{C}$ , $f = 1.0 \text{ MHz}$ )

Parameter	Symbol	Min	Typ	Max	Unit	Test conditions	Note
Input capacitance	$C_{in}$	—	—	8	pF	$V_{in} = 0 \text{ V}$	1
Input/output capacitance	$C_{I/O}$	—	—	10	pF	$V_{I/O} = 0 \text{ V}$	1

Note: 1. This parameter is sampled and not 100% tested.

## HM62162514I Series

**AC Characteristics** ( $T_a = -40$  to  $+85^\circ\text{C}$ ,  $V_{CC} = 5.0\text{ V} \pm 10\%$ , unless otherwise noted.)

### Test Conditions

- Input pulse levels:  $V_{IL} = 0.4\text{ V}$ ,  $V_{IH} = 2.2\text{ V}$
- Input rise and fall time:  $5\text{ ns}$
- Input and output timing reference levels:  $1.5\text{ V}$
- Output load:  $1\text{ TTL Gate} + C_L (50\text{ pF})$  (Including scope and jig)

### Read Cycle

Parameter	Symbol	HM6216514I		Unit	Notes
		Min	Max		
Read cycle time	$t_{RC}$	55	—	ns	
Address access time	$t_{AA}$	—	55	ns	
Chip select access time	$t_{ACS}$	—	55	ns	
Output enable to output valid	$t_{OE}$	—	35	ns	
Output hold from address change	$t_{OH}$	10	—	ns	
$\overline{LB}$ , $\overline{UB}$ access time	$t_{BA}$	—	55	ns	
Chip select to output in low-Z	$t_{CLZ}$	10	—	ns	2, 3
$\overline{LB}$ , $\overline{UB}$ enable to low-z	$t_{BLZ}$	5	—	ns	2, 3
Output enable to output in low-Z	$t_{OLZ}$	5	—	ns	2, 3
Chip deselect to output in high-Z	$t_{CHZ}$	0	20	ns	1, 2, 3
$\overline{LB}$ , $\overline{UB}$ disable to high-Z	$t_{BHZ}$	0	20	ns	1, 2, 3
Output disable to output in high-Z	$t_{OHZ}$	0	20	ns	1, 2, 3

## HM6216514I Series

### Write Cycle

Parameter	Symbol	HM6216514I		Unit	Notes
		-5			
		Min	Max		
Write cycle time	$t_{WC}$	55	—	ns	
Address valid to end of write	$t_{AW}$	50	—	ns	
Chip selection to end of write	$t_{CW}$	50	—	ns	5
Write pulse width	$t_{WP}$	40	—	ns	4
$\overline{LB}$ , $\overline{UB}$ valid to end of write	$t_{BW}$	50	—	ns	
Address setup time	$t_{AS}$	0	—	ns	6
Write recovery time	$t_{WR}$	0	—	ns	7
Data to write time overlap	$t_{DW}$	25	—	ns	
Data hold from write time	$t_{DH}$	0	—	ns	
Output active from end of write	$t_{OW}$	5	—	ns	2
Output disable to output in high-Z	$t_{OHZ}$	0	20	ns	1, 2
Write to output in high-Z	$t_{WHZ}$	0	20	ns	1, 2

Notes: 1.  $t_{CHZ}$ ,  $t_{OHZ}$ ,  $t_{WHZ}$  and  $t_{BHZ}$  are defined as the time at which the outputs achieve the open circuit conditions and are not referred to output voltage levels.

- This parameter is sampled and not 100% tested.
- At any given temperature and voltage condition,  $t_{HZ}$  max is less than  $t_{LZ}$  min both for a given device and from device to device.
- A write occurs during the overlap of a low  $\overline{CS}$ , a low  $\overline{WE}$  and a low  $\overline{LB}$  or a low  $\overline{UB}$ . A write begins at the latest transition among  $\overline{CS}$  going low,  $\overline{WE}$  going low and  $\overline{LB}$  going low or  $\overline{UB}$  going low. A write ends at the earliest transition among  $\overline{CS}$  going high,  $\overline{WE}$  going high and  $\overline{LB}$  going high or  $\overline{UB}$  going high.  $t_{WP}$  is measured from the beginning of write to the end of write.
- $t_{CW}$  is measured from the later of  $\overline{CS}$  going low to the end of write.
- $t_{AS}$  is measured from the address valid to the beginning of write.
- $t_{WR}$  is measured from the earliest of  $\overline{CS}$  or  $\overline{WE}$  going high to the end of write cycle.

Timing Waveform

Read Cycle

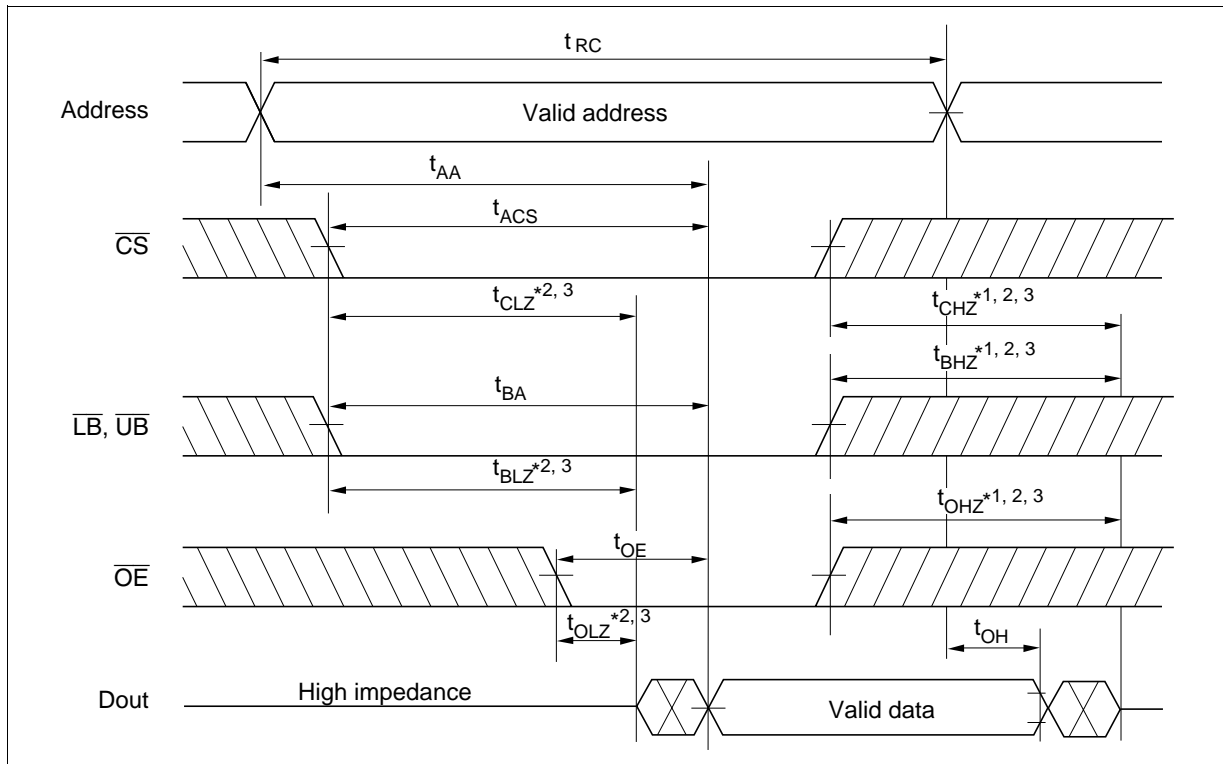

## HM6216514I Series

### Write Cycle (1) ( $\overline{\text{WE}}$ Clock)

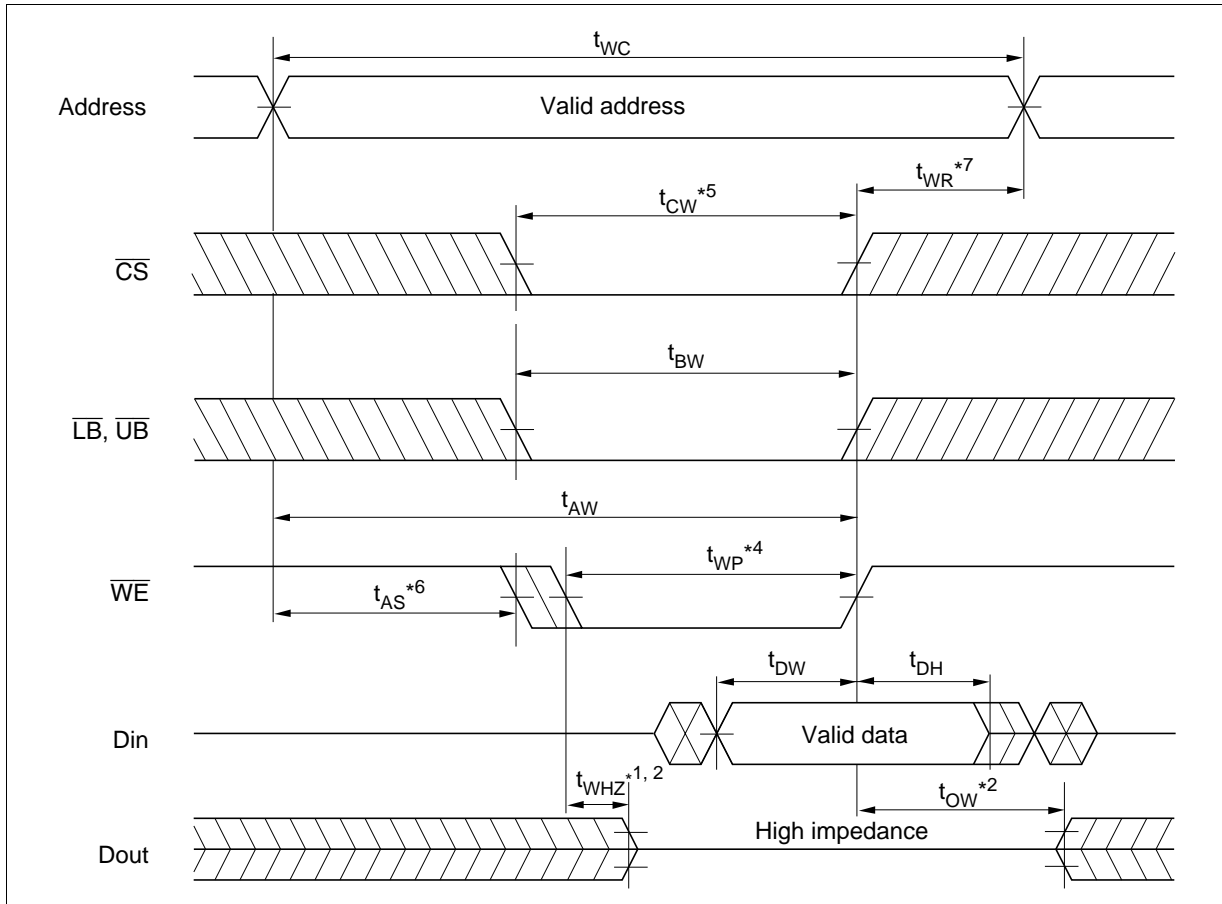

Write Cycle (2) ( $\overline{\text{CS}}$  Clock,  $\overline{\text{OE}} = V_{\text{IH}}$ )

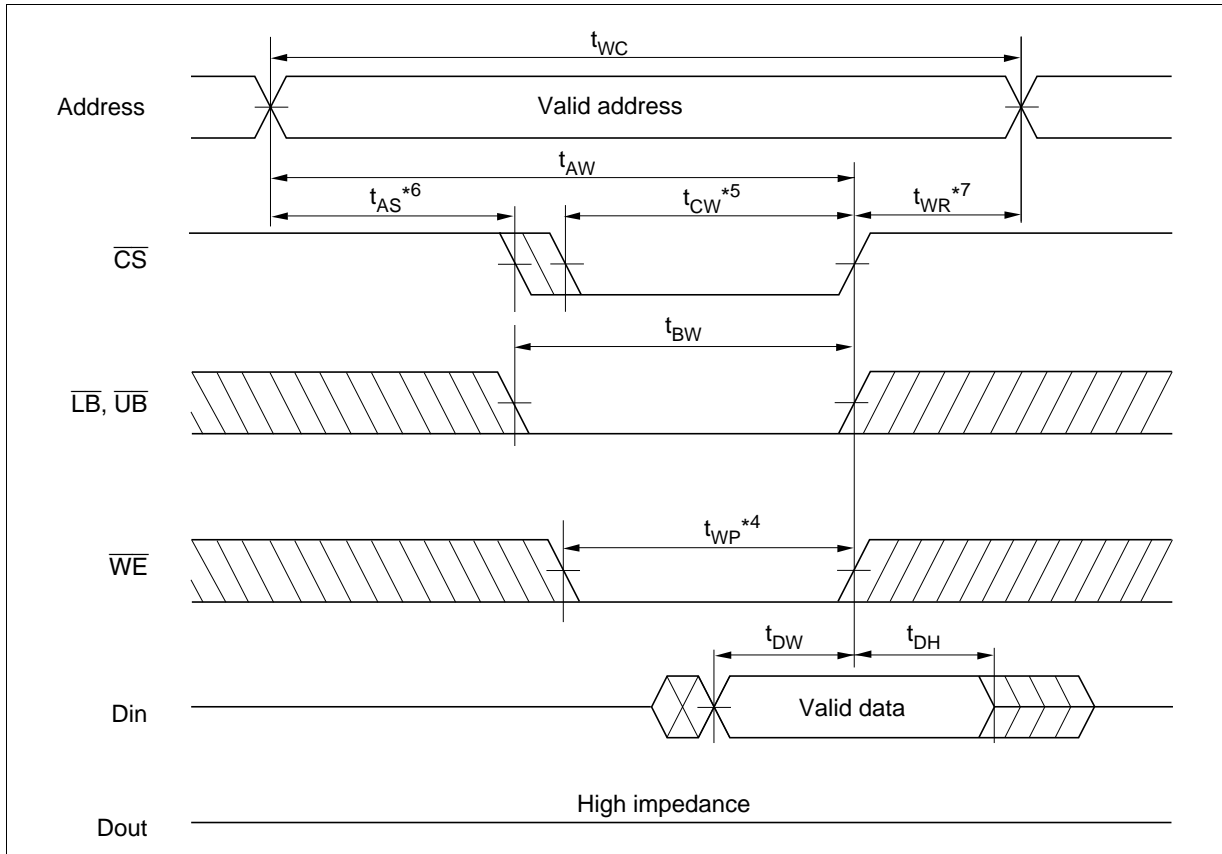

## HM6216514I Series

Write Cycle (3) ( $\overline{\text{LB}}$ ,  $\overline{\text{UB}}$  Clock,  $\overline{\text{OE}} = V_{\text{IH}}$ )

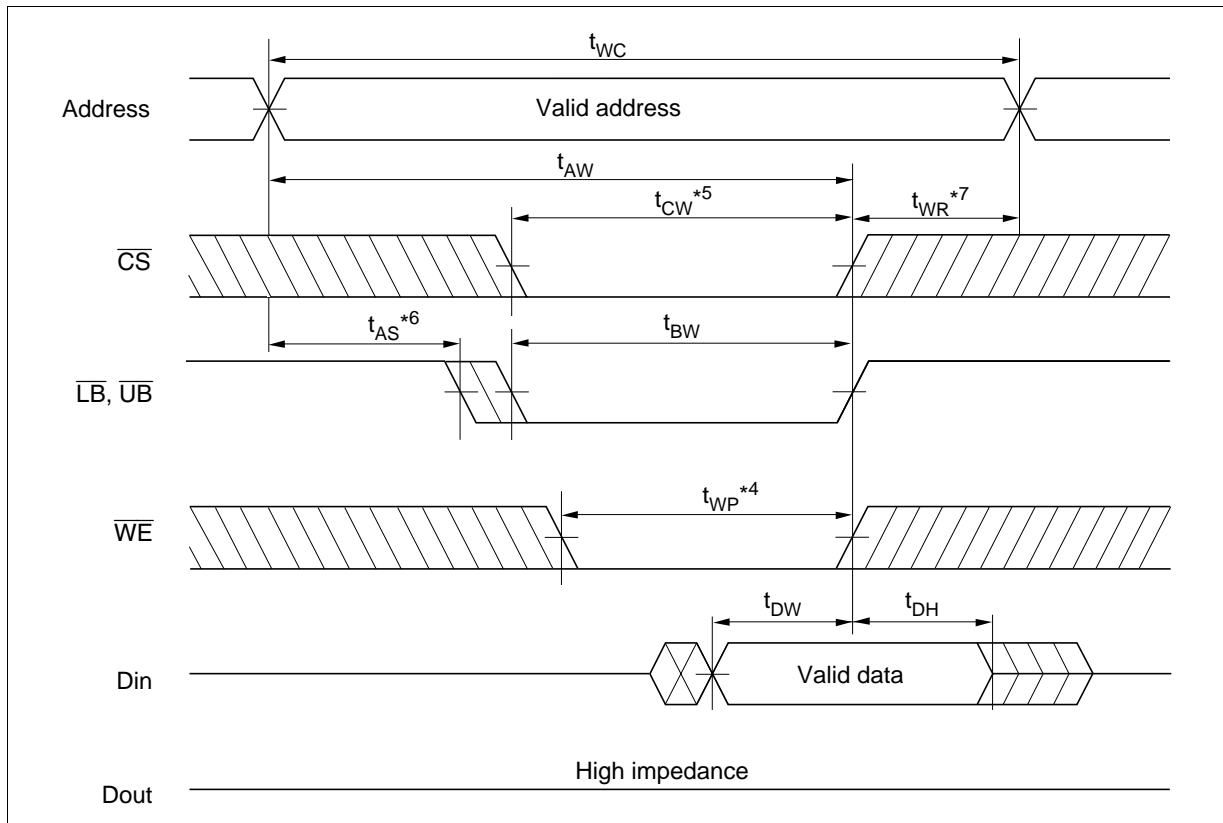



**Low  $V_{CC}$  Data Retention Characteristics** ( $T_a = -40$  to  $+85^\circ\text{C}$ )

Parameter	Symbol	Min	Typ* <sup>2</sup>	Max	Unit	Test conditions* <sup>1</sup>
$V_{CC}$ for data retention	$V_{DR}$	2.0	—	—	V	$V_{in} \geq 0V$ (1) $\overline{CS} \geq V_{CC} - 0.2V$ or (2) $\overline{LB} = \overline{UB} \geq V_{CC} - 0.2V$ $\overline{CS} \leq 0.2V$
Data retention current	$I_{CCDR}$	—	0.8	10	$\mu\text{A}$	$V_{CC} = 3.0V$ , $V_{in} \geq 0V$ (1) $\overline{CS} \geq V_{CC} - 0.2V$ or (2) $\overline{LB} = \overline{UB} \geq V_{CC} - 0.2V$ $\overline{CS} \leq 0.2V$
Chip deselect to data retention time	$t_{CDR}$	0	—	—	ns	See retention waveform
Operation recovery time	$t_R$	$t_{RC}$ * <sup>3</sup>	—	—	ns	

Notes: 1.  $\overline{CS}$  controls address buffer,  $\overline{WE}$  buffer,  $\overline{OE}$  buffer,  $\overline{LB}$ ,  $\overline{UB}$  buffer and Din buffer. If  $\overline{CS}$  controls data retention mode,  $V_{in}$  levels (address,  $\overline{WE}$ ,  $\overline{OE}$ ,  $\overline{LB}$ ,  $\overline{UB}$ , I/O) can be in the high impedance state. If  $\overline{LB}$ ,  $\overline{UB}$  controls data retention mode,  $\overline{LB}$ ,  $\overline{UB}$  must be  $\overline{LB} = \overline{UB} \geq V_{CC} - 0.2V$ ,  $\overline{CS}$  must be  $\overline{CS} \leq 0.2V$ . The other input levels (address,  $\overline{WE}$ ,  $\overline{OE}$ , I/O) can be in the high impedance state.

2. Typical values are at  $V_{CC} = 3.0V$ ,  $T_a = +25^\circ\text{C}$  and not guaranteed.

3.  $t_{RC}$  = read cycle time.

## HM6216514I Series

Low  $V_{CC}$  Data Retention Timing Waveform (1) ( $\overline{CS}$  Controlled)

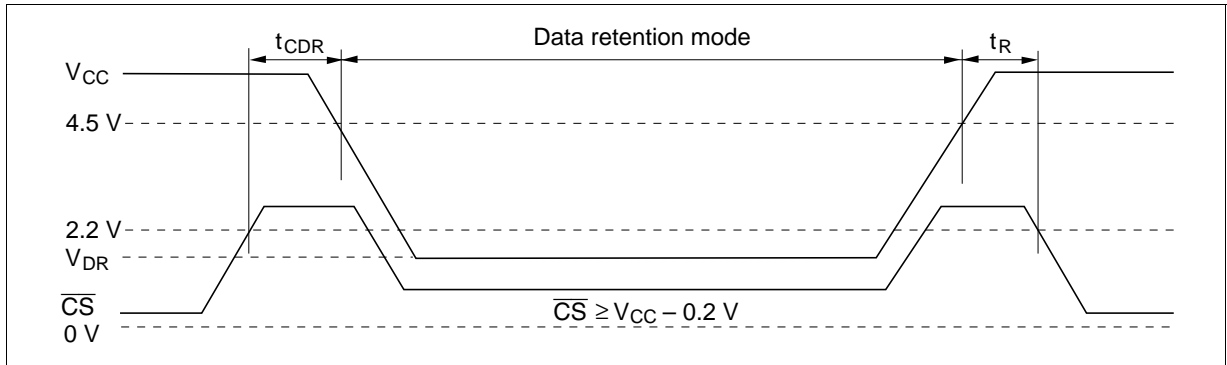

Low  $V_{CC}$  Data Retention Timing Waveform (2) ( $\overline{LB}$ ,  $\overline{UB}$  Controlled)

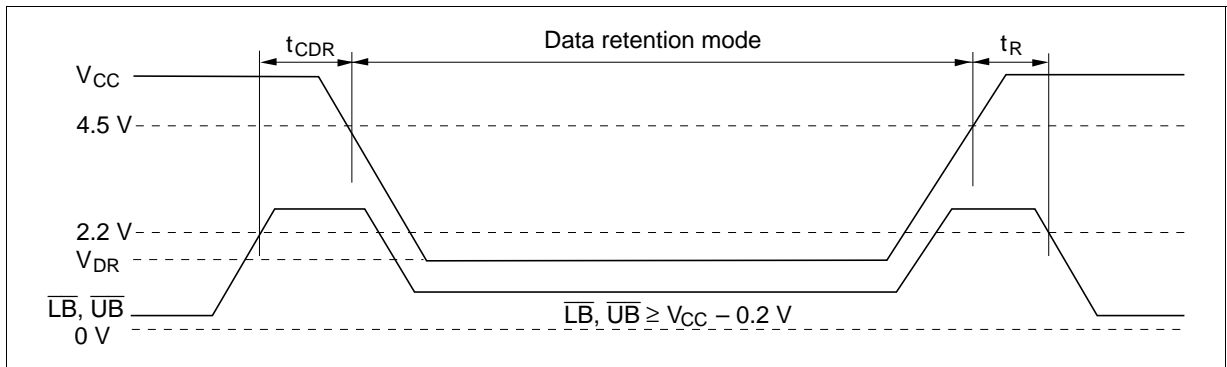

## HM62162514I Series

### Package Dimensions

#### HM6216514LTTI Series (TTP-44DE)

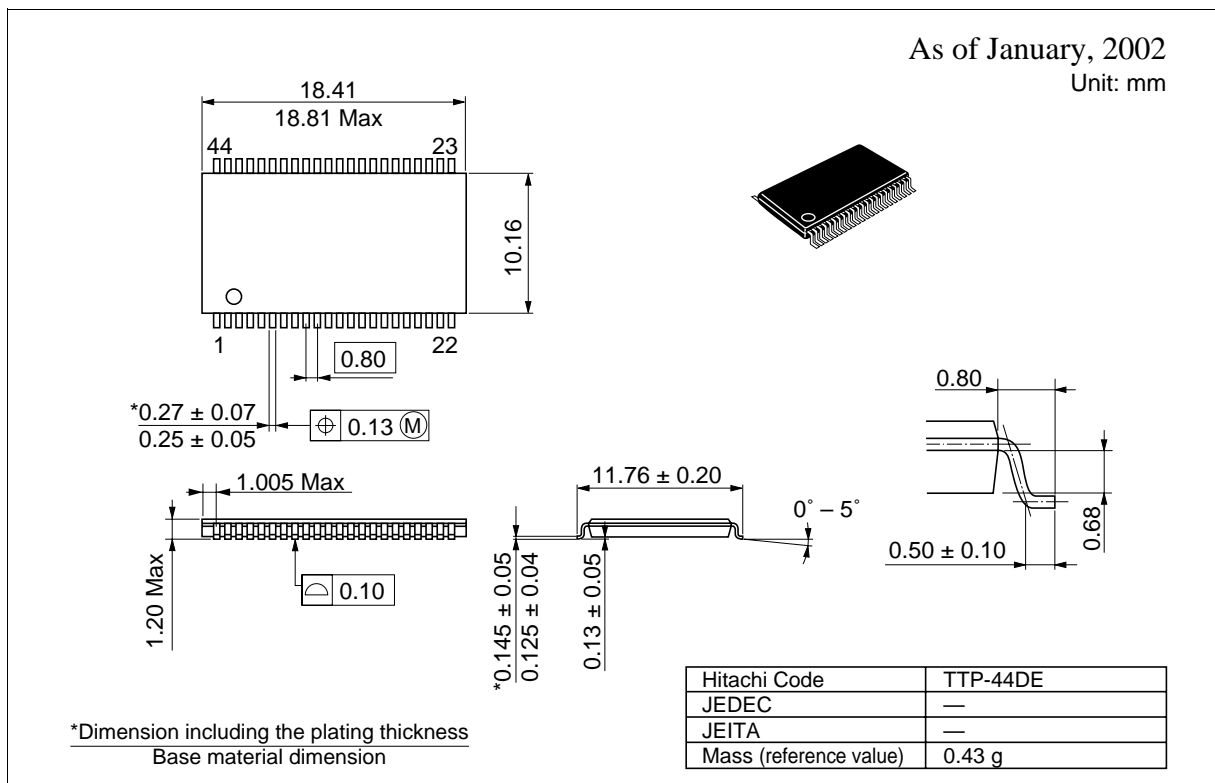

---

## HM6216514I Series

---

### Cautions

1. Hitachi neither warrants nor grants licenses of any rights of Hitachi's or any third party's patent, copyright, trademark, or other intellectual property rights for information contained in this document. Hitachi bears no responsibility for problems that may arise with third party's rights, including intellectual property rights, in connection with use of the information contained in this document.
2. Products and product specifications may be subject to change without notice. Confirm that you have received the latest product standards or specifications before final design, purchase or use.
3. Hitachi makes every attempt to ensure that its products are of high quality and reliability. However, contact Hitachi's sales office before using the product in an application that demands especially high quality and reliability or where its failure or malfunction may directly threaten human life or cause risk of bodily injury, such as aerospace, aeronautics, nuclear power, combustion control, transportation, traffic, safety equipment or medical equipment for life support.
4. Design your application so that the product is used within the ranges guaranteed by Hitachi particularly for maximum rating, operating supply voltage range, heat radiation characteristics, installation conditions and other characteristics. Hitachi bears no responsibility for failure or damage when used beyond the guaranteed ranges. Even within the guaranteed ranges, consider normally foreseeable failure rates or failure modes in semiconductor devices and employ systemic measures such as fail-safes, so that the equipment incorporating Hitachi product does not cause bodily injury, fire or other consequential damage due to operation of the Hitachi product.
5. This product is not designed to be radiation resistant.
6. No one is permitted to reproduce or duplicate, in any form, the whole or part of this document without written approval from Hitachi.
7. Contact Hitachi's sales office for any questions regarding this document or Hitachi semiconductor products.

---

---

# HITACHI

## Hitachi, Ltd.

Semiconductor & Integrated Circuits  
Nippon Bldg., 2-6-2, Ohte-machi, Chiyoda-ku, Tokyo 100-0004, Japan  
Tel: (03) 3270-2111 Fax: (03) 3270-5109

URL <http://www.hitachisemiconductor.com/>

### For further information write to:

Hitachi Semiconductor  
(America) Inc.  
179 East Tasman Drive  
San Jose, CA 95134  
Tel: <1> (408) 433-1990  
Fax: <1> (408) 433-0223

Hitachi Europe Ltd.  
Electronic Components Group  
Whitebrook Park  
Lower Cookham Road  
Maidenhead  
Berkshire SL6 8YA, United Kingdom  
Tel: <44> (1628) 585000  
Fax: <44> (1628) 778322

Hitachi Europe GmbH  
Electronic Components Group  
Dornacher Str 3  
D-85622 Feldkirchen  
Postfach 201, D-85619 Feldkirchen  
Germany  
Tel: <49> (89) 9 9180-0  
Fax: <49> (89) 9 29 30 00

Hitachi Asia Ltd.  
Hitachi Tower  
16 Collyer Quay #20-00  
Singapore 049318  
Tel: <65>-6538-6533/6538-8577  
Fax: <65>-6538-6933/6538-3877  
URL: <http://semiconductor.hitachi.com.sg>

Hitachi Asia Ltd.  
(Taipei Branch Office)  
4/F, No. 167, Tun Hwa North Road  
Hung-Kuo Building  
Taipei (105), Taiwan  
Tel: <886>-(2)-2718-3666  
Fax: <886>-(2)-2718-8180  
Telex: 23222 HAS-TP  
URL: <http://semiconductor.hitachi.com.tw>

Hitachi Asia (Hong Kong) Ltd.  
Group III (Electronic Components)  
7/F., North Tower  
World Finance Centre,  
Harbour City, Canton Road  
Tsim Sha Tsui, Kowloon Hong Kong  
Tel: <852>-2735-9218  
Fax: <852>-2730-0281  
URL: <http://semiconductor.hitachi.com.hk>

Copyright©Hitachi, Ltd., 2002. All rights reserved. Printed in Japan.

Colophon 7.0

**RENESAS**

## X-ON Electronics

Largest Supplier of Electrical and Electronic Components

*Click to view similar products for [SRAM](#) category:*

*Click to view products by [Renesas](#) manufacturer:*

Other Similar products are found below :

[5962-8855206XA](#) [CY6116A-35DMB](#) [CY7C128A-45DMB](#) [CY7C1461KV33-133AXI](#) [CY7C199-45LMB](#) [CYDM128B16-55BVXIT](#)  
[GS8161Z36DD-200I](#) [GS88237CB-200I](#) [R1QDA7236ABB-20IB0](#) [RMLV0408EGSB-4S2#AA0](#) [IS64WV3216BLL-15CTLA3](#)  
[IS66WVE4M16ECLL-70BLI](#) [PCF8570P](#) [K6T4008C1B-GB70](#) [CY7C1353S-100AXC](#) [AS6C8016-55BIN](#) [515712X](#) [IS62WV51216EBLL-](#)  
[45BLI](#) [IS63WV1288DBLL-10HLI](#) [IS66WVE2M16ECLL-70BLI](#) [47L16-E/SN](#) [IS66WVE4M16EALL-70BLI](#) [IS62WV6416DBLL-45BLI](#)  
[IS61WV102416DBLL-10TLI](#) [CY7C1381KV33-100AXC](#) [CY7C1381KV33-100BZXI](#) [CY7C1373KV33-100AXC](#) [CY7C1381KVE33-133AXI](#)  
[CY7C4042KV13-933FCXC](#) [8602501XA](#) [5962-3829425MUA](#) [5962-8855206YA](#) [5962-8866201XA](#) [5962-8866201YA](#) [5962-8866204TA](#)  
[5962-8866206MA](#) [5962-8866207NA](#) [5962-8866208UA](#) [5962-8872502XA](#) [5962-8959836MZA](#) [5962-8959841MZA](#) [5962-9062007MXA](#)  
[5962-9161705MXA](#) [N08L63W2AB7I](#) [7130LA100PDG](#) [GS882Z18CD-150I](#) [GS81284Z36B-250I](#) [M38510/28902BVA](#) [IS62WV12816ALL-](#)  
[70BLI](#) [5962-8971203XA](#)