

ISL15110

PLC MIMO Line Driver

FN8282
Rev 1.00
Apr 6, 2018

The [ISL15110](#) is a dual port differential line driver developed for Power Line Communication (PLC) Multi Input Multi Output (MIMO) applications. MIMO PLC requires transmission on one or two pairs of Phase, Neutral, and Ground wires. The device is designed to drive heavy line loads while maintaining a high level of linearity required in OFDM PLC modem links. With 15.5dBm of total MIMO transmit signal power (12.5dBm per each pair) into a 50Ω line load, the drivers deliver -50dB average MTPR distortion across the output spectrum.

Each of the two differential drivers has a control pin to enable and disable its differential output. These controls allow for independent TDM operation of the two differential drivers, as required in ITU-T MIMO G.hn and related standard based PLC applications. In disable mode, the line driver output maintains a high impedance characteristic to preserve TDM receive signal integrity.

The ISL15110 includes an external IBIAS pin for quiescent current flexibility. Grounding the pin in single supply designs gives the nominal currents in the “Electrical Specifications” table starting on [page 5](#), while inserting a resistor from pin to ground can be used to scale down the quiescent current for both ports.

The ISL15110 is available in the thermally-enhanced 20 Ld QFN and is specified for operation across the full -40°C to +85°C temperature range.

Related Literature

For a full list of related documents, visit our website

- [ISL15110](#) product page

Features

- Dual differential drivers
- 50MHz broadband PLC G.hn
- Enable/disable control pins for TDM operation
- -50dBc average MTPR distortion
- Single supply +12V nominal operation
- Enhanced surge current handling capability
- Thermally enhanced 20 Ld QFN package
- Enable port control voltage <0.7V
- Disable port control voltage >1.7V

Applications

- Home networking over power lines
- ITU-T G.hn (G.9963) MIMO PLC

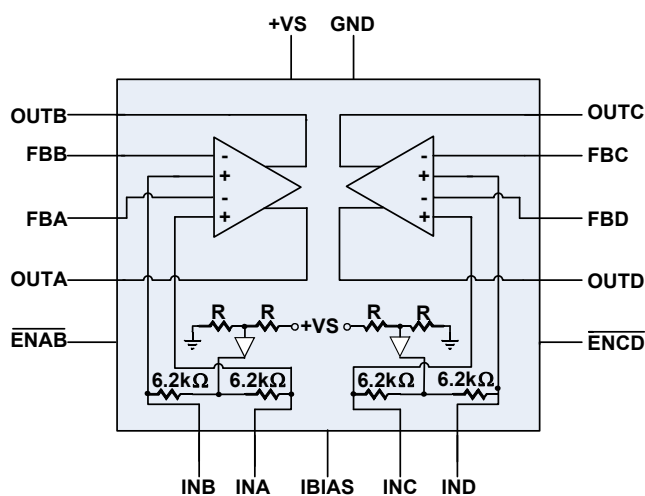

FIGURE 1. BLOCK DIAGRAM

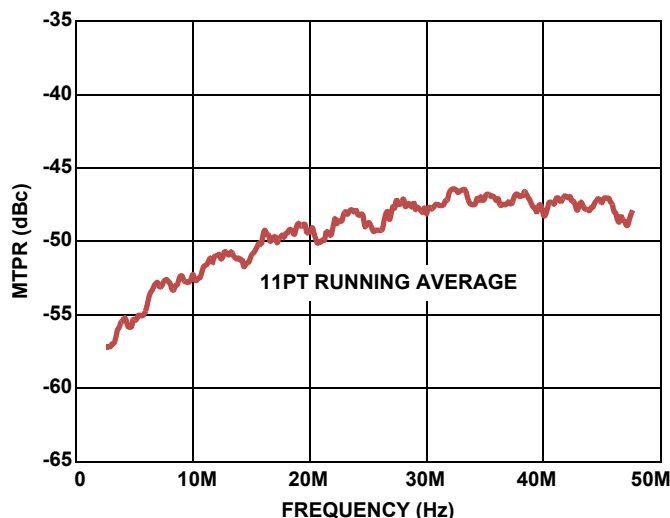

FIGURE 2. SISO 15.5dBm, 2MHz TO 50MHz MTPR TEST

Typical Application Circuit

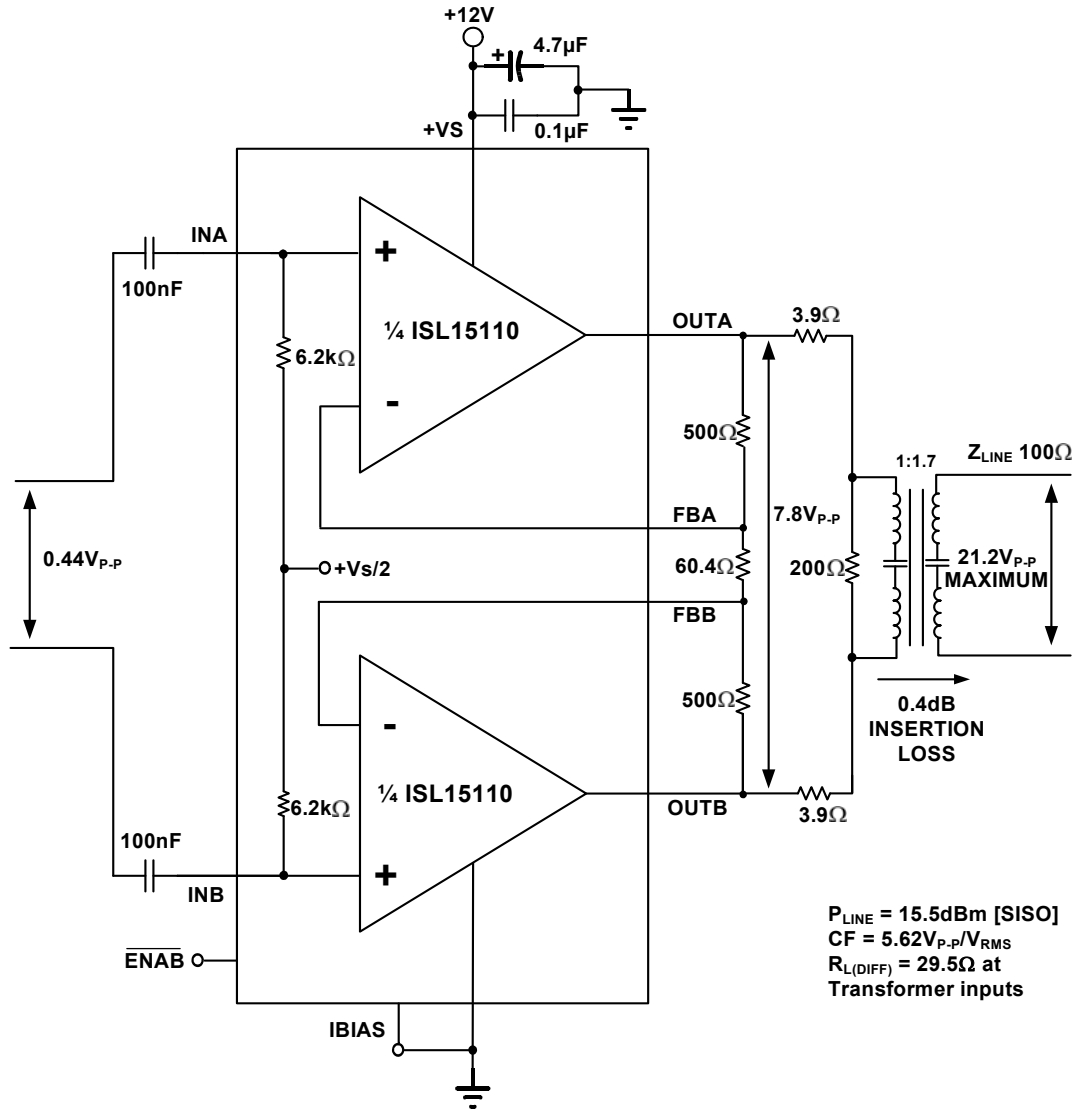
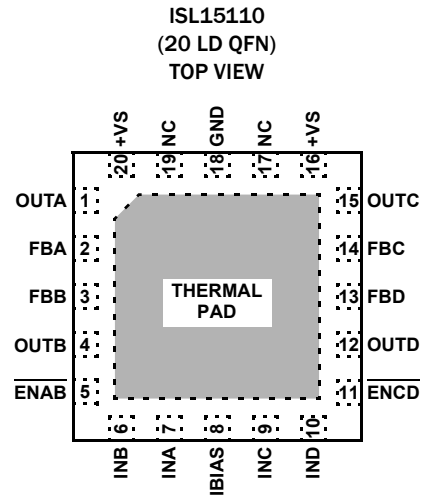

FIGURE 3. TYPICAL APPLICATION CIRCUIT (1 of 2 PORTS)

Pin Configuration



Pin Descriptions

PIN NUMBER	PIN NAME	FUNCTION
0	THERMAL PAD	Connects to GND
1	OUTA	Amplifier A output
2	FBA	Amplifier A inverting input
3	FBB	Amplifier B inverting input
4	OUTB	Amplifier B output
5	$\overline{\text{ENAB}}$	Port 1 enable/disable control
6	INB	Amplifier B non-inverting input
7	INA	Amplifier A non-inverting input
8	IBIAS	Ports 1 and 2 quiescent current control
9	INC	Amplifier C non-inverting input
10	IND	Amplifier D non-inverting input
11	$\overline{\text{ENCD}}$	Port 2 enable/disable control
12	OUTD	Amplifier D output
13	FBD	Amplifier D inverting input
14	FBC	Amplifier C inverting input
15	OUTC	Amplifier C output
16, 20	+VS	Voltage supply
17, 19	NC	No connect
18	GND	Ground

Ordering Information

PART NUMBER (Notes 2, 3)	PART MARKING	TEMP RANGE (°C)	TAPE AND REEL (UNITS) (Note 1)	PACKAGE (RoHS COMPLIANT)	PKG. DWG. #
ISL15110IRZ	151 10IRZ	-40 to +85	-	20 Ld QFN	L20.4x4C
ISL15110IRZ-T7	151 10IRZ	-40 to +85	1k	20 Ld QFN	L20.4x4C
ISL15110IRZ-T13	151 10IRZ	-40 to +85	6k	20 Ld QFN	L20.4x4C

NOTES:

1. Refer to [TB347](#) for details about reel specifications.
2. These Pb-free plastic packaged products employ special Pb-free material sets, molding compounds/die attach materials, and 100% matte tin plate plus anneal (e3 termination finish, which is RoHS compliant and compatible with both SnPb and Pb-free soldering operations). Pb-free products are MSL classified at Pb-free peak reflow temperatures that meet or exceed the Pb-free requirements of IPC/JEDEC J STD-020.
3. For Moisture Sensitivity Level (MSL), refer to the [ISL15110](#) product information page. For more information about MSL, refer to [TB363](#).

Absolute Maximum Ratings ($T_A = +25^\circ\text{C}$)

V_{S+} Voltage to GND	-0.3V to +13.3V
Driver V_{IN+} Voltage	.GND to V_{S+}
V_{CM} Voltage to GND	.GND to V_{S+}
Current Into Any input	.8mA
Continuous Output Current for Long Term Reliability	50mA
ESD Rating	
Human Body Model (Tested per JESD22-A114F)	4kV
Machine Model (Tested per JESD22-A115C)	500V
Charge Device Model (Tested per JESD22-C101E)	1.5kV

Thermal Information

Thermal Resistance (Typical)	θ_{JA} ($^\circ\text{C}/\text{W}$)	θ_{JC} ($^\circ\text{C}/\text{W}$)
20 Ld QFN Package (Notes 4, 5)	43	6.5
Thermal Characteristics (Typical)	Ψ_{JT} ($^\circ\text{C}/\text{W}$)	Ψ_{JB} ($^\circ\text{C}/\text{W}$)
20 Ld QFN Package	4	18
Maximum Junction Temperature (Plastic Package)	+150 $^\circ\text{C}$	
Power Dissipation	see page 14	
Storage Temperature Range	-40 $^\circ\text{C}$ to +150 $^\circ\text{C}$	
Pb-Free Reflow Profile	see TB493	

Operating Conditions

Ambient Temperature Range	-40 $^\circ\text{C}$ to +85 $^\circ\text{C}$
Junction Temperature Range	-40 $^\circ\text{C}$ to +150 $^\circ\text{C}$

CAUTION: Do not operate at or near the maximum ratings listed for extended periods of time. Exposure to such conditions may adversely impact product reliability and result in failures not covered by warranty.

NOTES:

- θ_{JA} is measured in free air with the component mounted on a high-effective thermal conductivity test board with "direct attach" features. See TB379.
- For θ_{JC} , the "case temp" location is the center of the exposed metal pad on the package underside.

Electrical Specifications $V_S = +12\text{V}$, Gain = 17.6V/V, $R_f = 500\Omega$, $R_{L-DIFF} = 29.5\Omega$ differential, $I_{BIAS} = \text{GND}$, $T_A = +25^\circ\text{C}$. Ports are tested separately unless otherwise indicated (see Figure 3).

PARAMETER	SYMBOL	CONDITIONS	MIN (Note 6)	TYP	MAX (Note 6)	UNITS
AC PERFORMANCE						
-3dB Bandwidth	BW	$A_V = 12\text{dB}$, [5V/V]		120		MHz
		$A_V = 25\text{dB}$, [17.6V/V]		80		MHz
Passband Ripple ($f < 50\text{MHz}$)	RIP			1		dB
Slew Rate	SR	Differential V_{OUT} from -6V to +6V		1600		V/ μs
Multi-Tone Power Ratio (Power Cutback Added Back For Frequency > 30MHz)	MTPR	2MHz to 50MHz, 25kHz Tone Spacing, $P_{LINE} = 15.5\text{dBm}$, CF = 15dB, $V_S = 10.8\text{V}$, $T_A = 0^\circ\text{C}$ to +85 $^\circ\text{C}$	-43			dBc
Off State Multi-Tone Power Ratio (Power Cutback Added Back For Frequency > 30MHz)	MTPR OFF	2MHz to 50MHz, 25kHz Tone Spacing, $P_{LINE} = 15.5\text{dBm}$, CF = 15dB	-48			dBc
Non-Inverting Input Voltage Noise	eN	$f = 1\text{MHz}$		6		nV/ $\sqrt{\text{Hz}}$
Non-Inverting Input Current Noise	iN+	$f = 1\text{MHz}$		13		pA/ $\sqrt{\text{Hz}}$
Inverting Input Current Noise	iN-	$f = 1\text{MHz}$		50		pA/ $\sqrt{\text{Hz}}$
POWER CONTROL FEATURES						
Logic High Current for $\overline{\text{ENAB}}$, $\overline{\text{ENCD}}$	I _{HAB} , I _{HCD}	$\overline{\text{ENAB}}$, $\overline{\text{ENCD}} = 3.3\text{V}$	70	98	115	μA
Logic Low Current for $\overline{\text{ENAB}}$, $\overline{\text{ENCD}}$	I _{LAB} , I _{LCD}	$\overline{\text{ENAB}}$, $\overline{\text{ENCD}} = 0\text{V}$	-5	-2	0	μA
Logic High Voltage for $\overline{\text{ENAB}}$, $\overline{\text{ENCD}}$	V _{HAB} , V _{HCD}	$\overline{\text{ENAB}}$ and $\overline{\text{ENCD}}$ Inputs [Port Disable]	1.7			V
Logic Low Voltage for $\overline{\text{ENAB}}$, $\overline{\text{ENCD}}$	V _{LAB} , V _{LCD}	$\overline{\text{ENAB}}$ and $\overline{\text{ENCD}}$ Inputs [Port Enable]			0.7	V
SUPPLY CHARACTERISTICS						
Supply Voltage Range	V_S	Single Supply	10.8	12	13.2	V
Supply Current - MIMO [Dual Port Operation]	I_S -MIMO	$\overline{\text{ENAB}}$, $\overline{\text{ENCD}} = 0\text{V}$	44.5	50	56.5	mA
Supply Current - SISO [Single Port Operation]	I_S -SISO	$\overline{\text{ENAB}} = 3.3\text{V}$ and $\overline{\text{ENCD}} = 0\text{V}$ or $\overline{\text{ENAB}} = 0\text{V}$ and $\overline{\text{ENCD}} = 3.3\text{V}$	26.5	30	33	mA

Electrical Specifications $V_S = +12V$, Gain = 17.6V/V, $R_f = 500\Omega$, $R_{L-DIFF} = 29.5\Omega$ differential, $I_{BIAS} = GND$, $T_A = +25^\circ C$. Ports are tested separately unless otherwise indicated (see [Figure 3](#)). (Continued)

PARAMETER	SYMBOL	CONDITIONS	MIN (Note 6)	TYP	MAX (Note 6)	UNITS
Supply Current - Power Down [For Two Ports]	IS OFF	$\overline{ENAB}, \overline{ENCD} = 3.3V$	7.4	8.0	9.5	mA
Maximum Power Consumption - MIMO [Dual Port Operation]	P-MIMO	$\overline{ENAB} = \overline{ENCD} = 0V$, $P_L = 12.5dBm$ per channel		1040	1090	mW
		$V_S = 13.2V$		1145	1200	mW
Maximum Power Consumption - SISO [Single Port Operation]	P-SISO	$\overline{ENAB} = 0V$, $\overline{ENCD} = 3.3V$, $P_{LA} = 15.5dBm$ or $\overline{ENAB} = 3.3V$, $\overline{ENCD} = 0V$, $P_{LB} = 15.5dBm$		590	720	mW
		$V_S = 13.2V$		650	790	mW
OUTPUT CHARACTERISTICS						
Loaded Output Swing (Single-ended)	$V_{OUT HI}$	$R_L = 37.3\Omega$ across output pins	10.7	10.8		V
	$V_{OUT LO}$	$R_L = 37.3\Omega$ across output pins		1.2	1.6	V
Output Offset Voltage Differential Mode	V_{OS-DM} Output	(OUTA - OUTB) or (OUTC - OUTD)	-100		100	mV
Output Offset Voltage Common Mode	V_{OS-CM} Output	Delta to $+V_S/2$	-75		125	mV
Output Short Circuit Current	I_{SC}	$R_L = 0\Omega$		2000		mA
INPUT CHARACTERISTICS						
Input Offset Voltage Differential Mode	V_{OS-DM}	(INA - INB) or (INC - IND)	-6	0	+6	mV
Input Offset Voltage Common Mode	V_{OS-CM}	Delta to $+V_S/2$	-50	-18	0	mV
Non-Inverting Input Bias Current	+IB		-14	-3	+12	μA
Non-Inverting Input Bias Current Differential Mode	+IB _{DM}	(+IB _A - +IB _B) or (+IB _C - +IB _D)	-2	0	+2	μA
Inverting Input Bias Current Differential Mode (Mismatch)	-IB _{DM}	(-IB _A - -IB _B) or (-IB _C - -IB _D)	-50	± 20	+50	μA
Common Mode Input Range at each of the 4 Non-Inverting Input Pins	CMIR	Delta to $+V_S/2$	-3	± 3.5	+3	V
Common Mode Rejections for each Port $V_{CM} = -3V$ to $+3V$	CMRR	V_{CM} to Differential Mode Output	48	60		dB
		V_{CM} to Common Mode Output	45	50		dB
Power Supply Rejection for each Port	PSRR	PSRR to Differential Mode Input $+V_S = +10.8V$ to $+13.2V$, $GND = 0V$, DC	73	90		dB
		PSRR to Common Mode Output Balanced shift in $\pm V_S$ [bipolar supply]	42	60		dB
Differential Input Impedance	$Z_{IN-DIFF}$		10	12.4	14	k Ω

NOTE:

6. Compliance to datasheet limits is assured by one or more methods: production test, characterization, and/or design.

Typical Performance Curves

$V_{CC} = +12V$, Gain = 17.6V/V (Differential), $R_f = 500\Omega$, $R_{LOAD} = 29.5\Omega$, $T_A = +25^\circ C$, $I_{BIAS} = 0\Omega$ to GND (Full Power). Each Port (see Figure 3), unless otherwise noted.

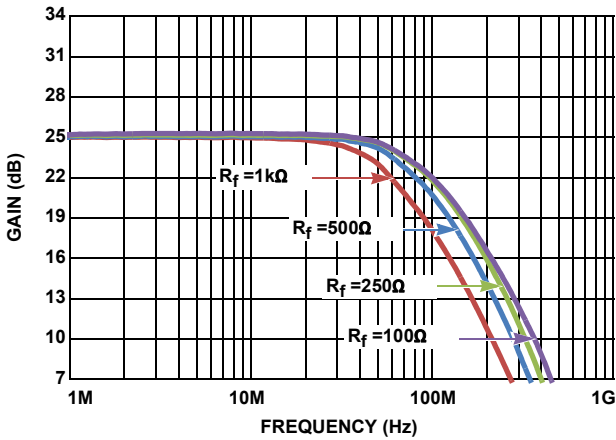

FIGURE 4. SMALL SIGNAL FREQUENCY RESPONSE vs R_f

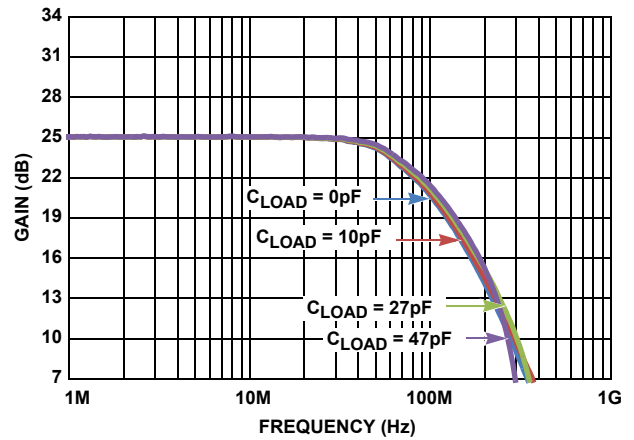

FIGURE 5. SMALL SIGNAL FREQUENCY RESPONSE vs C_{LOAD}

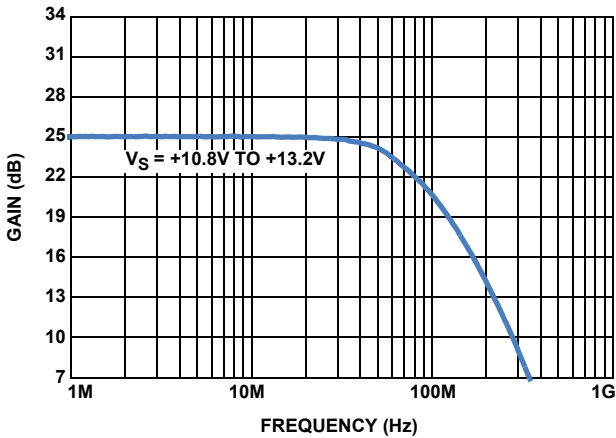

FIGURE 6. SMALL SIGNAL BW vs SUPPLY VOLTAGE

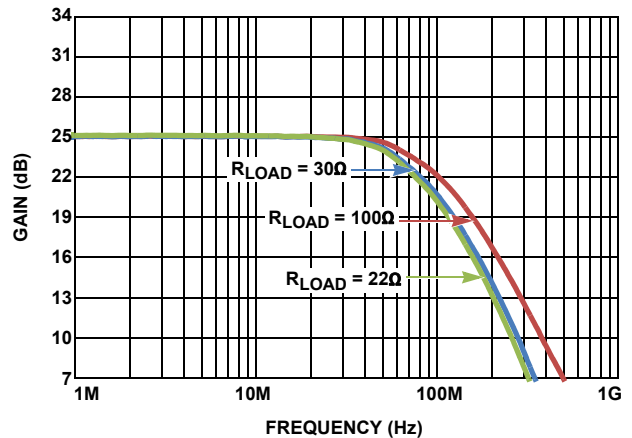

FIGURE 7. SMALL SIGNAL FREQUENCY RESPONSE vs R_{LOAD}

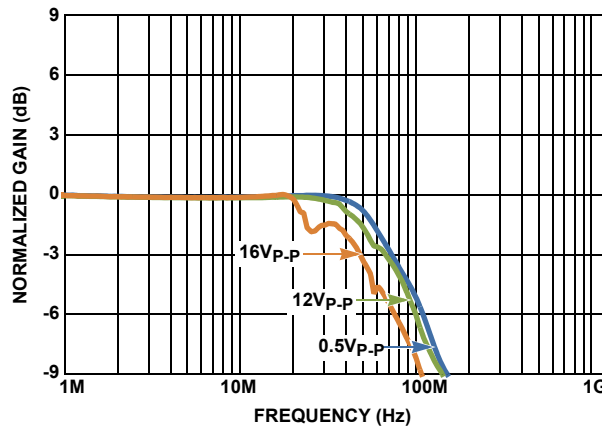

FIGURE 8. LARGE SIGNAL FREQUENCY RESPONSE

Typical Performance Curves

$V_{CC} = +12V$, Gain = 17.6V/V (Differential), $R_f = 500\Omega$, $R_{LOAD} = 29.5\Omega$, $T_A = +25^\circ C$, $I_{BIAS} = 0\Omega$ to GND (Full Power). Each Port (see Figure 3), unless otherwise noted. (Continued)

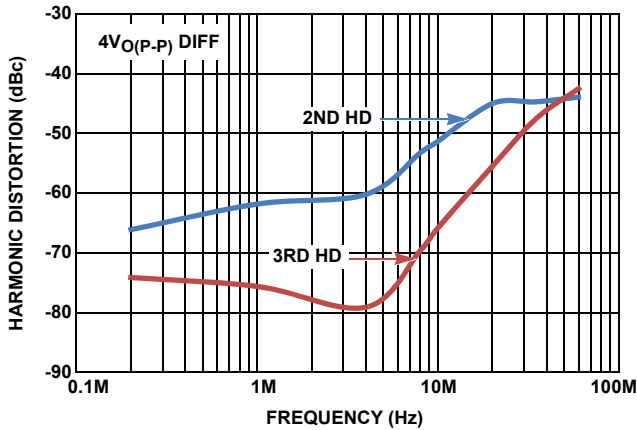

FIGURE 9. HARMONIC DISTORTION vs FREQUENCY

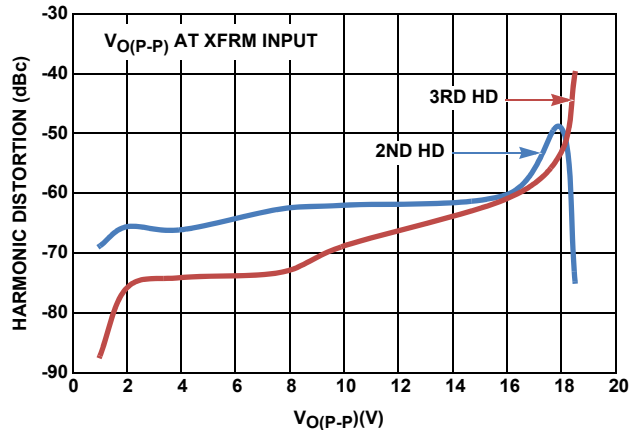

FIGURE 10. 200kHz HARMONIC DISTORTION vs OUTPUT VOLTAGE

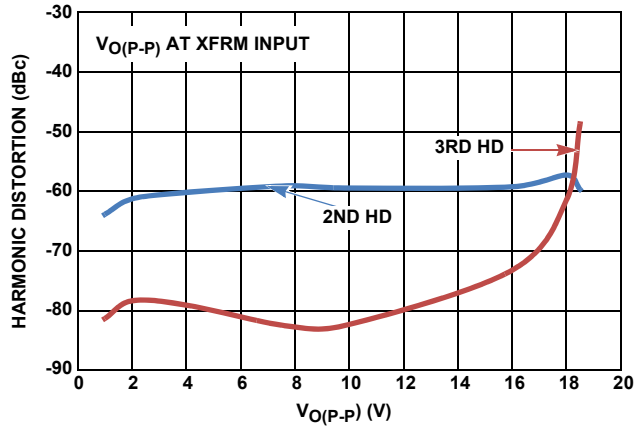

FIGURE 11. 4MHz HARMONIC DISTORTION vs OUTPUT VOLTAGE

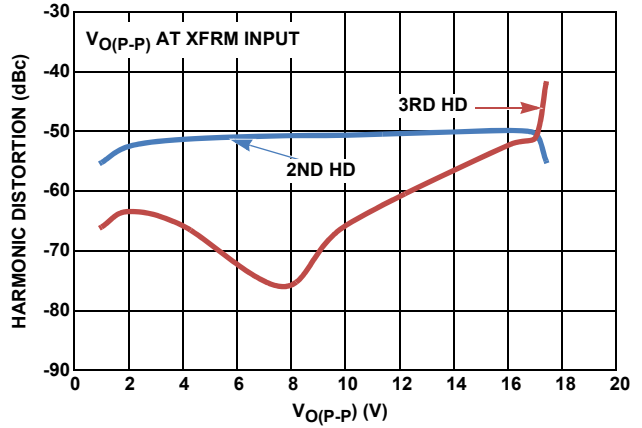

FIGURE 12. 10MHz HARMONIC DISTORTION vs OUTPUT VOLTAGE

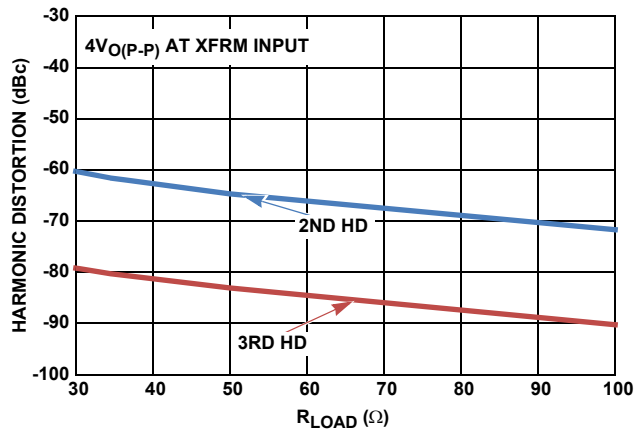

FIGURE 13. 4MHz HARMONIC DISTORTION vs R_{LOAD}

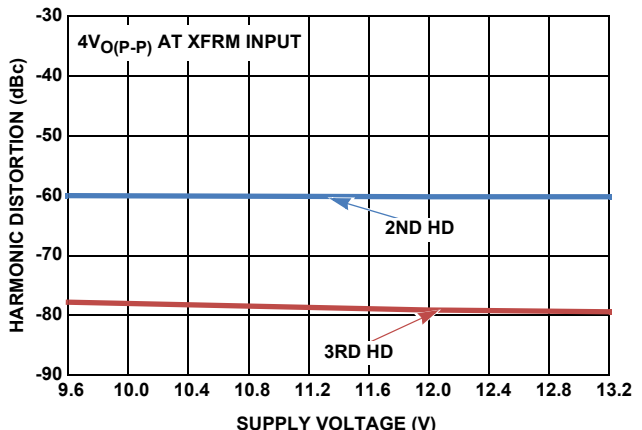

FIGURE 14. 4MHz HARMONIC DISTORTION vs SUPPLY VOLTAGE

Typical Performance Curves

$V_{CC} = +12V$, Gain = 17.6V/V (Differential), $R_f = 500\Omega$, $R_{LOAD} = 29.5\Omega$, $T_A = +25^\circ C$, $I_{BIAS} = 0\Omega$ to GND (Full Power). Each Port (see Figure 3), unless otherwise noted. (Continued)

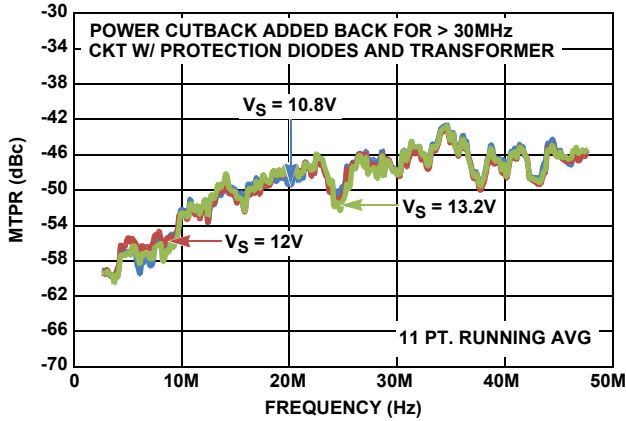

FIGURE 15. MTPR IN MIMO MODE WITH VARIOUS V_S (2MHz TO 50MHz)

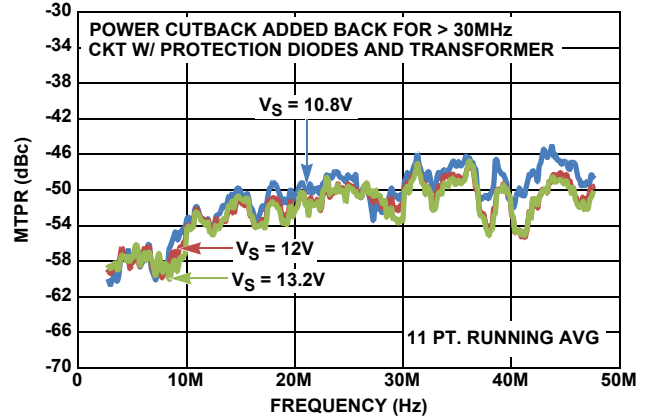

FIGURE 16. MTPR IN SISO MODE WITH VARIOUS V_S (2MHz TO 50MHz)

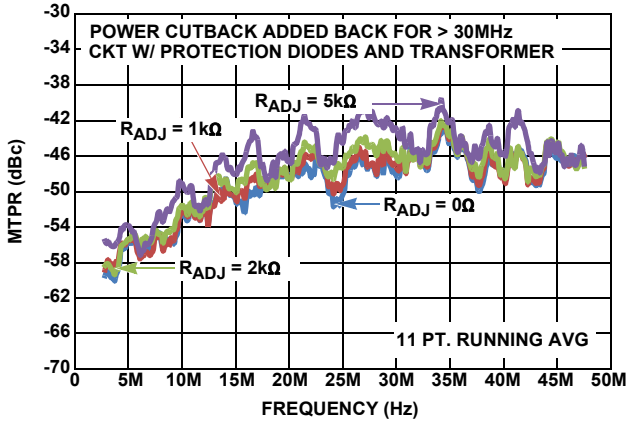

FIGURE 17. MTPR IN MIMO MODE WITH VARIOUS R_{ADJ} (2MHz TO 50MHz)

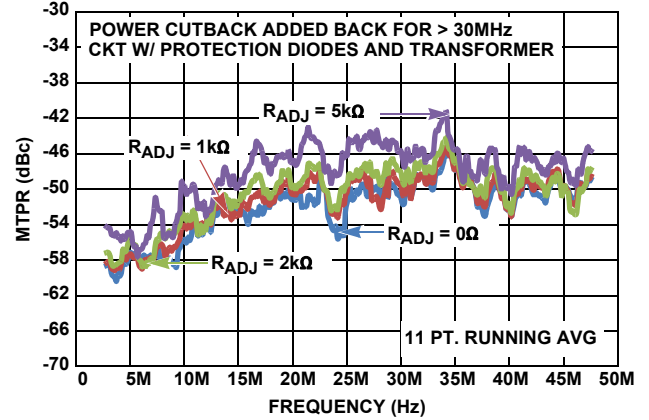

FIGURE 18. MTPR IN SISO MODE WITH VARIOUS R_{ADJ} (2MHz TO 50MHz)

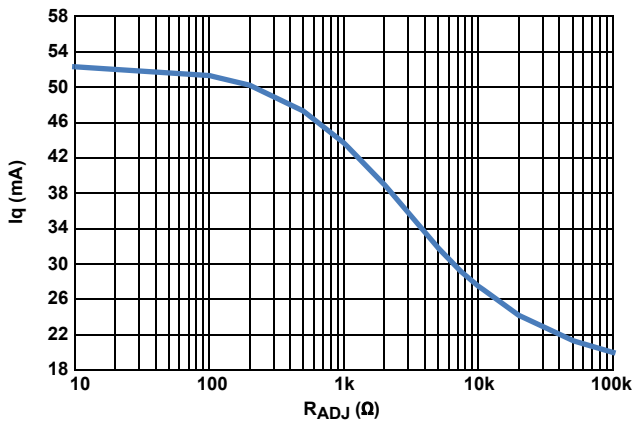

FIGURE 19. QUIESCENT CURRENT FOR I_{BIAS} (2 PORTS)

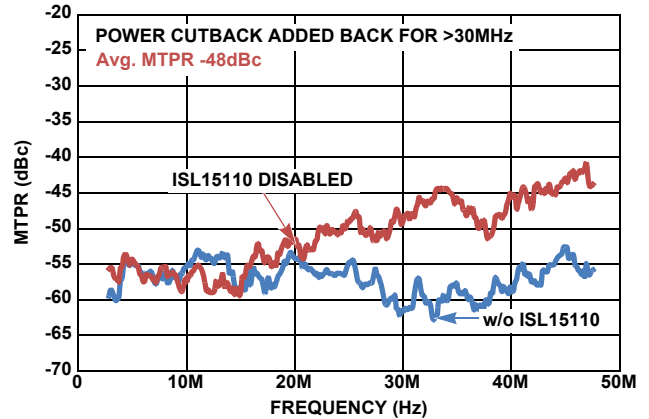

FIGURE 20. DISABLE MTPR LINEARITY AT OUTPUTS

Typical Performance Curves

$V_{CC} = +12V$, Gain = 17.6V/V (Differential), $R_f = 500\Omega$, $R_{LOAD} = 29.5\Omega$, $T_A = +25^\circ C$, $I_{BIAS} = 0\Omega$ to GND (Full Power). Each Port (see Figure 3), unless otherwise noted. (Continued)

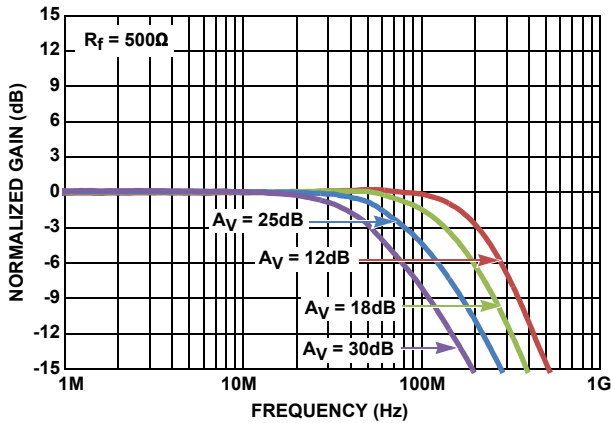

FIGURE 21. SMALL SIGNAL FREQUENCY RESPONSE vs GAINS

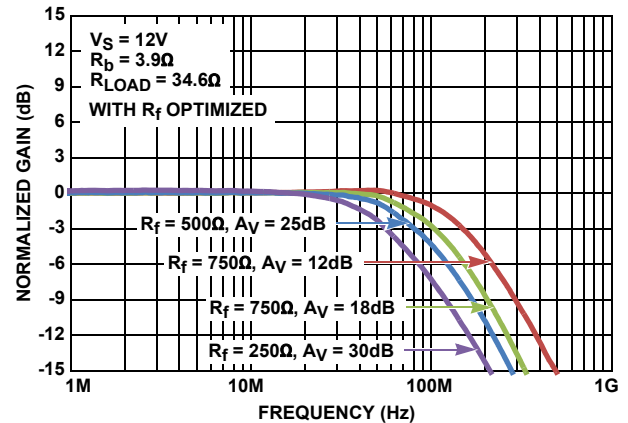

FIGURE 22. SMALL SIGNAL FREQUENCY RESPONSE vs GAINS

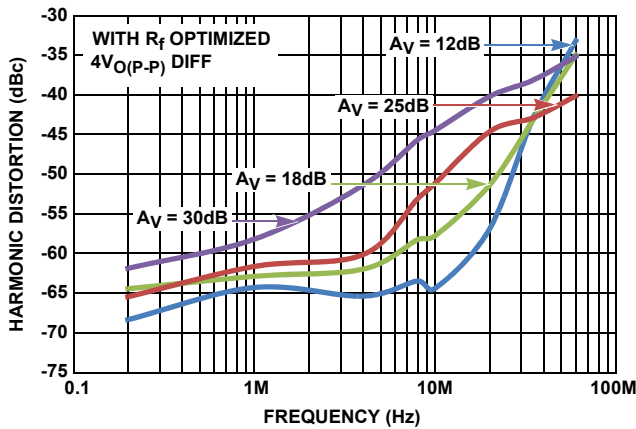

FIGURE 23. TOTAL HARMONIC DISTORTION vs FREQUENCY FOR VARIOUS GAINS

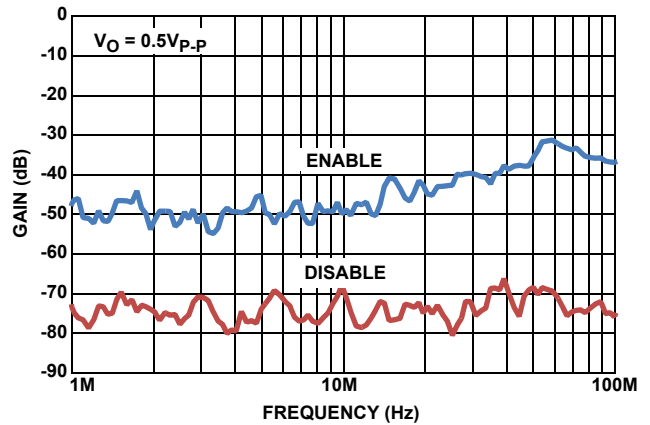

FIGURE 24. COMMON MODE INPUT TO DIFFERENTIAL OUTPUT FREQUENCY RESPONSE

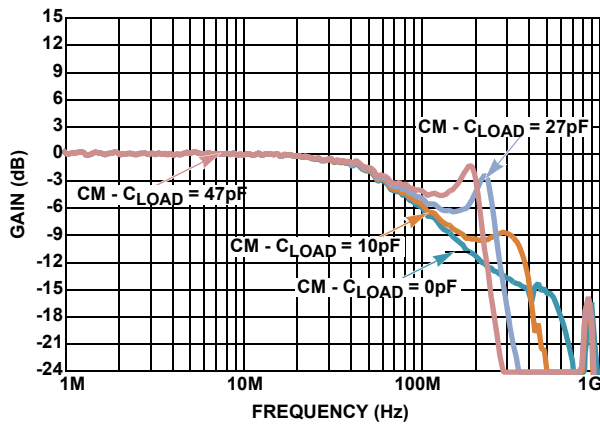

FIGURE 25. COMMON MODE SMALL SIGNAL FREQUENCY RESPONSE WITH VARIOUS C_{LOADS}

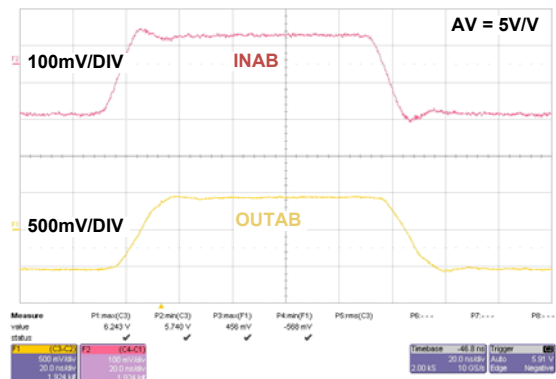

FIGURE 26. SMALL STEP RESPONSE

Typical Performance Curves

$V_{CC} = +12V$, Gain = 17.6V/V (Differential), $R_f = 500\Omega$, $R_{LOAD} = 29.5\Omega$, $T_A = +25^\circ C$, $I_{BIAS} = 0\Omega$ to GND (Full Power). Each Port (see Figure 3), unless otherwise noted. (Continued)

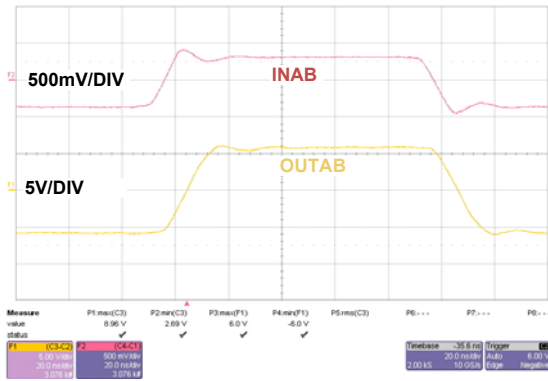

FIGURE 27. LARGE STEP RESPONSE

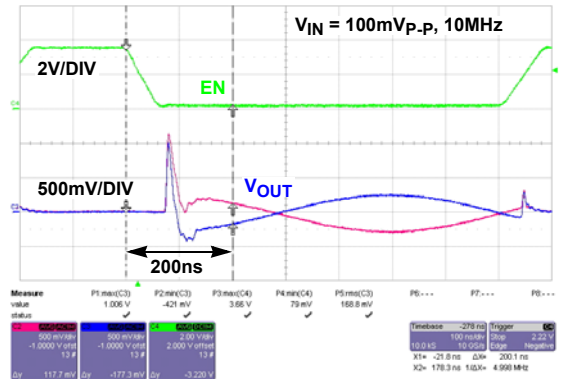

FIGURE 28. POWER ON TIME (t_{ON})

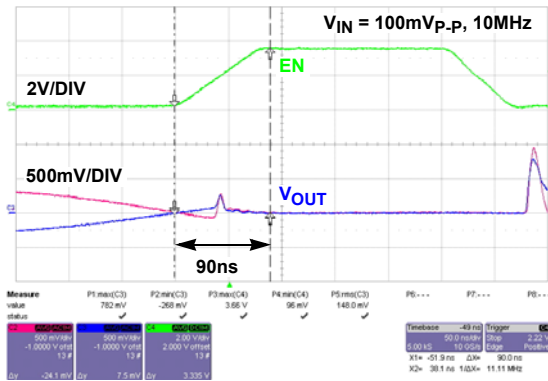

FIGURE 29. POWER OFF TIME (t_{OFF})

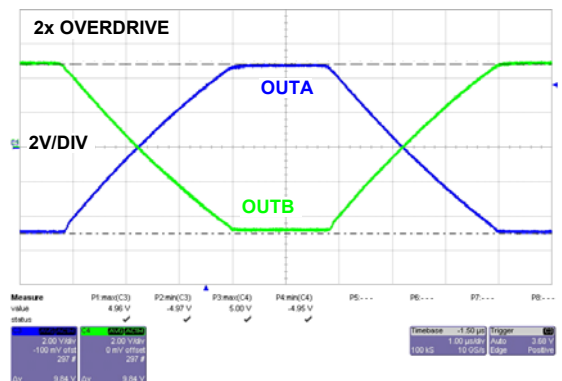

FIGURE 30. OVERDRIVE RECOVERY

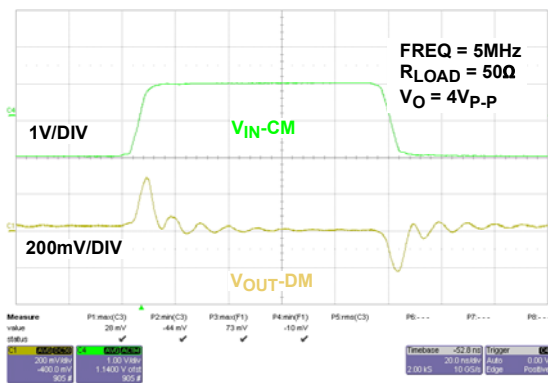

FIGURE 31. COMMON MODE INPUT TO DIFFERENTIAL OUTPUT STEP RESPONSE

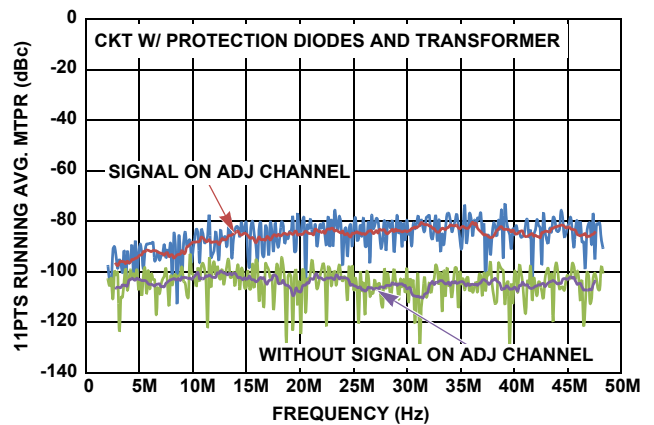

FIGURE 32. CROSSTALK IN SISO

Typical Performance Curves

$V_{CC} = +12V$, Gain = 17.6V/V (Differential), $R_f = 500\Omega$, $R_{LOAD} = 29.5\Omega$, $T_A = +25^\circ C$, $I_{BIAS} = 0\Omega$ to GND (Full Power). Each Port (see Figure 3), unless otherwise noted. (Continued)

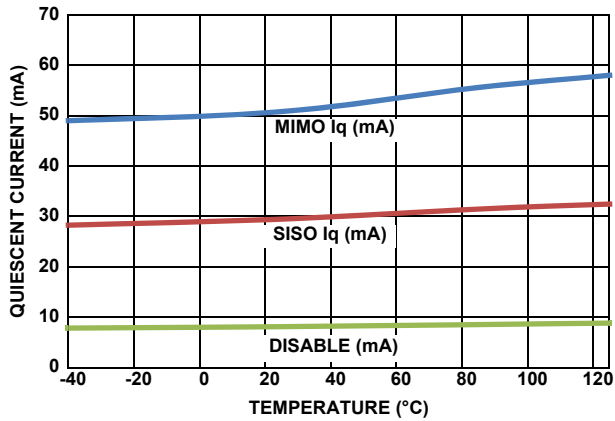

FIGURE 33. QUIESCENT CURRENT vs TEMPERATURE

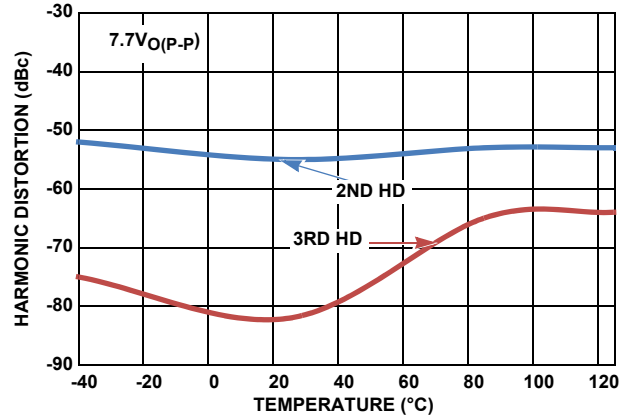

FIGURE 34. 4MHz HARMONIC DISTORTION vs TEMPERATURE

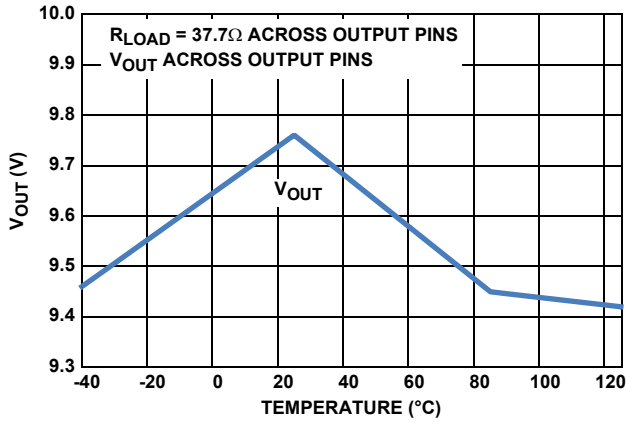

FIGURE 35. OUTPUT SWING vs TEMPERATURE

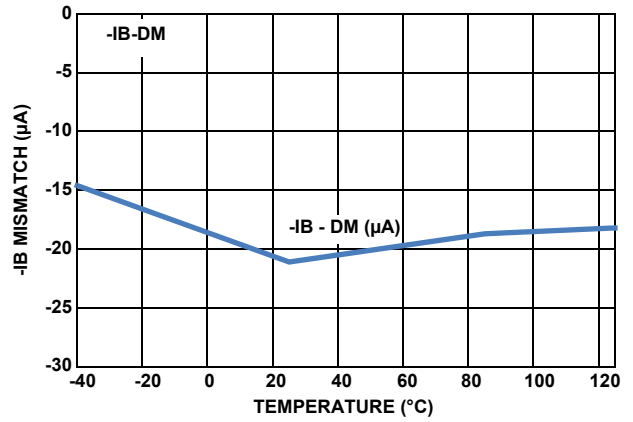

FIGURE 36. INVERTING INPUT BIAS CURRENT (MISMATCH) vs TEMPERATURE

Operation

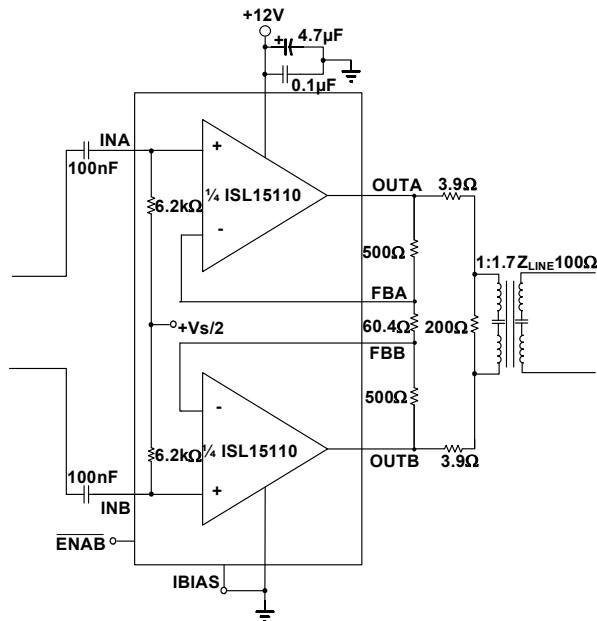

FIGURE 37. APPLICATION CIRCUIT (1 of 2 PORTS)

The ISL15110 consists of two pairs of Current Feedback Amplifiers (CFA): those used in power line communication and those used in (PLC) MIMO applications. The ISL15110 is well suited to the requirements of high output power, high full power bandwidth, and high output impedance in disable mode.

The AC characteristics are set by the 500Ω feedback resistors, as shown in Figure 37. The effects of increasing or decreasing the feedback resistors is shown in Figure 4. The ISL15110 shows a good flat response with smooth roll off with various feedback resistances. CFAs will generally roll off sooner with the increase in feedback resistance, and decreasing the feedback will peak the frequency response up and extend the bandwidth.

With the bandwidth fixed requirement by the feedback resistors, the gain can be adjusted by changing the 60.4Ω in Figure 37. The Figure 37 example sets the differential gain across OUTA, OUTB to:

$$\frac{OUTA}{INA} = \frac{500}{(60.4/2)} + 1 = 17.6 \left(\frac{V}{V} \right) \quad (\text{EQ. 1})$$

To get the gain to the input of the transformer in Figure 37, the attenuation of the resistor divider [3.9Ω and (200Ω || 34.6Ω)] is added to Equation 1, in which the 34.6Ω is the input referred load of 100Ω through the turns ratio squared.

Input Biasing and Input Impedance

The ISL15110 has integrated resistors at the inputs for mid rail biasing, as shown in Figures 1 and 3. The inputs require only external AC coupling capacitors. With a 100nF coupling capacitor and an input impedance of 6.2kΩ typical, the first order high pass cut off frequency is 257Hz.

Power Control Function

Each pair of drivers can be enabled and disabled by pulling low and high, respectively, on the EN pin. Putting 1.7V and greater on the EN pin will disable the differential driver, while putting 0.8V and less on the EN pin will enable the driver.

The ISL15110 includes an external IBIAS pin for biasing the quiescent current. Grounding the pin in single supply designs gives the nominal quiescent current shown in the “Electrical Specifications” table starting on page 5, while inserting a resistor from pin to ground will scale down the quiescent current for both drivers, as shown in Figure 19 on page 9.

Multi Tone Power Ratio (MTPR)

G.hn PLC uses OFDM modulation to digitally encode data for communication. A carrier spacing of 24.41kHz is used in power lines, and 48.82kHz is used in phone lines.

In multi-tone signaling, linearity is shown in the MTPR measurement. MTPR measures the difference in power of a carrier tone vs a missing tone.

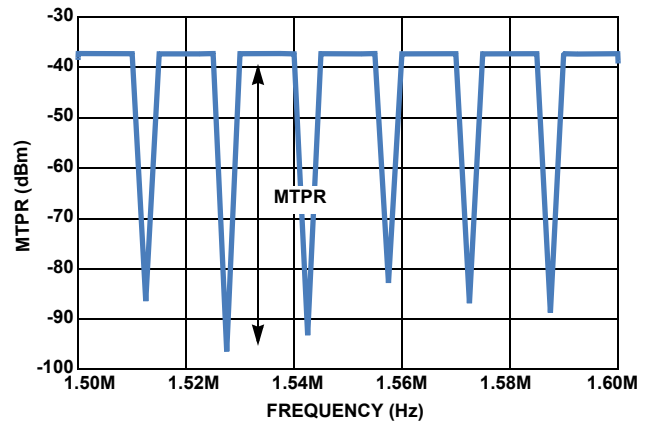

FIGURE 38. 2MHz to 50MHz PLC SIGNAL WITH 25kHz SPACING

Figure 38 shows the ISL15110MTPR in SISO mode. The curve shows an MTPR average of five symbols with an additional 11pt running average of that average. A -45dBc worst case MTPR is measured with a -50dBc, which is the typical number across the 2MHz to 50MHz transmit band.

Disable Linearity

Unlike DSL, communication in a PLC system is half duplex, meaning one device can transmit at a time. When the line driver is not transmitting, the line driver is disabled with the receiver ready to receive. Figure 39 on page 14 shows the shared transmit and receive signal path of two ends. RBMs are resistors to limit fault currents and provide a driving impedance to the transformer, thus setting its frequency span. Their values are typically low (<10Ω). When Tx is transmitting, optimal MTPR can be received by Rx if Tx is removed. Because Tx is present, the ideal output of the line driver is to behave at high impedance when disabled. Figure 20 on page 9 shows the linearity at the outputs with the ISL15110 disabled. An average MTPR of -48dBc is achieved.

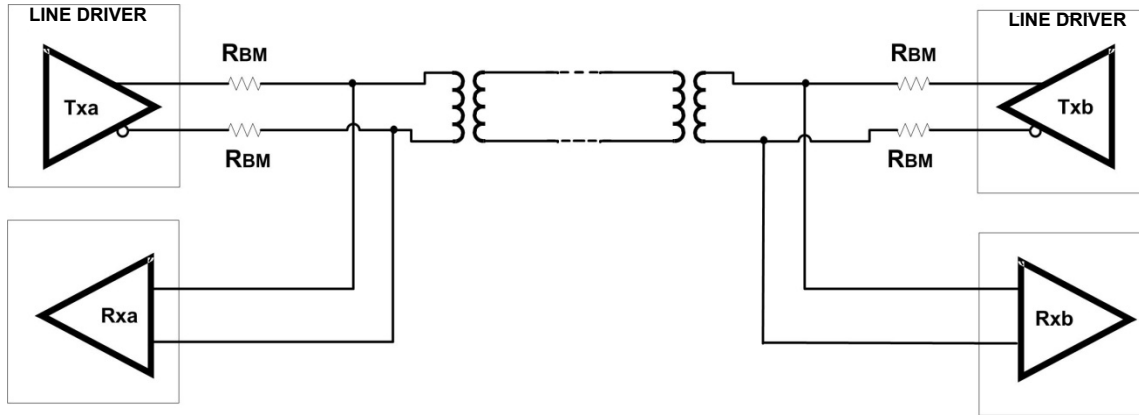

FIGURE 39. Tx and Rx SIGNAL PATH. CASE1: [Tx_a: ON, Rx_a: OFF, Tx_b: OFF, Rx_b: ON]. CASE2: [Tx_a: OFF, Rx_a: ON, Tx_b: ON, Rx_b: OFF]

Board Design Recommendation

To minimize parasitic capacitance in the ISL15110 design, lay out short output traces and select low capacitance protection devices and line transformers with low interwinding capacitance in the signal path.

The supply decoupling capacitors are also placed close to the supply pins to minimize parasitic inductance in the supply path. High frequency load currents are typically pulled through these capacitors, so close placement of the 0.1µF capacitors on the supply pin will improve dynamic performance. The higher 4.7µF value capacitors can be placed farther from the supply pins because they provide low frequency decoupling.

The thermal pad for the ISL15110 should be connected to ground in single supply applications. For good thermal control, run vias to a bottom pad to help dissipate heat away from the package. The ISL15110 evaluation board uses nine 20mil diameter vias with 10mil holes.

Thermal Resistance and Power Dissipation

Thermal resistance for junction to ambient, T_{JA} , is +43°C/W. The maximum power dissipation for MIMO at the 13.2V supply is 1200mW. The ambient temperature allowed given the maximum junction temperature of +150°C is:

$$T_A = T_J - \theta_{JA} \times P_d \tag{EQ. 2}$$

$$T_A = +150^\circ\text{C} - 43^\circ(\text{C}/\text{W}) * 1.2 = +98.4^\circ\text{C}$$

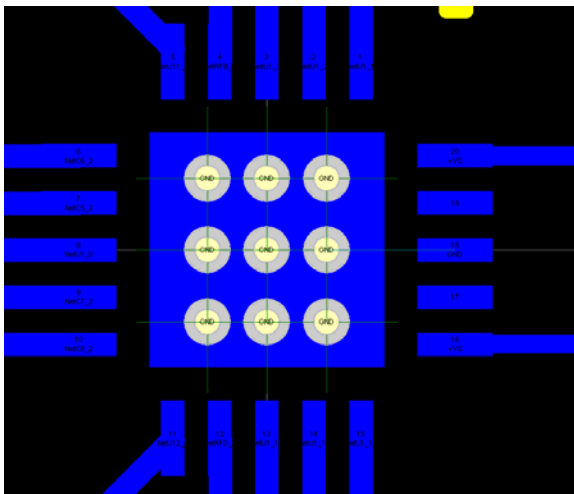

FIGURE 40. ISL15110 EVALUATION BOARD

Revision History The revision history provided is for informational purposes only and is believed to be accurate, but not warranted. Please visit our website to make sure you have the latest revision.

DATE	REVISION	CHANGE
Apr 6, 2018	FN8282.1	Added Related Literature section to page 1. Updated Ordering information table by adding tape and reel quantity column. Updated Note 3. Removed About Intersil section and added Renesas disclaimer.
Jan 31, 2013	FN8282.0	Initial release

Package Outline Drawing

L20.4x4C

20 LEAD QUAD FLAT NO-LEAD PLASTIC PACKAGE

Rev 0, 11/06

For the most recent package outline drawing, see [L20.4x4C](#).

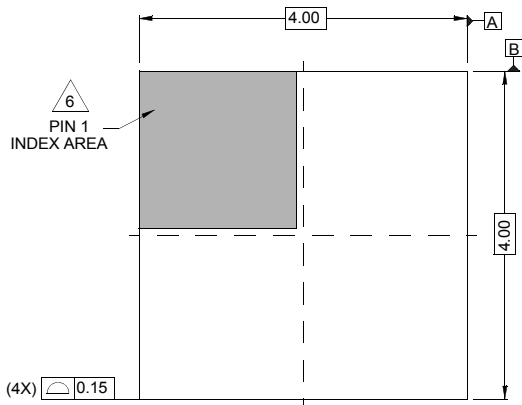

TOP VIEW

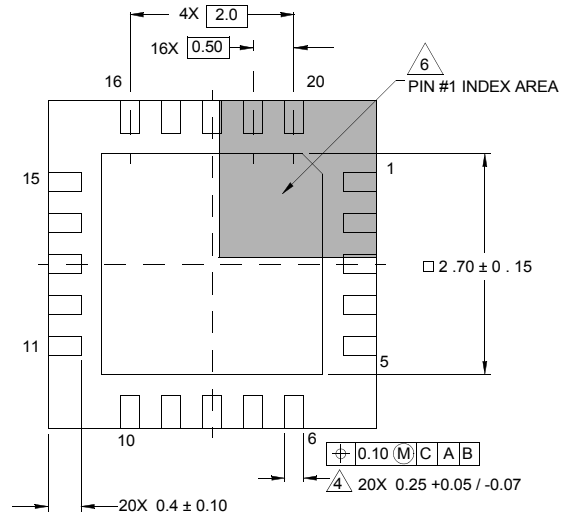

BOTTOM VIEW

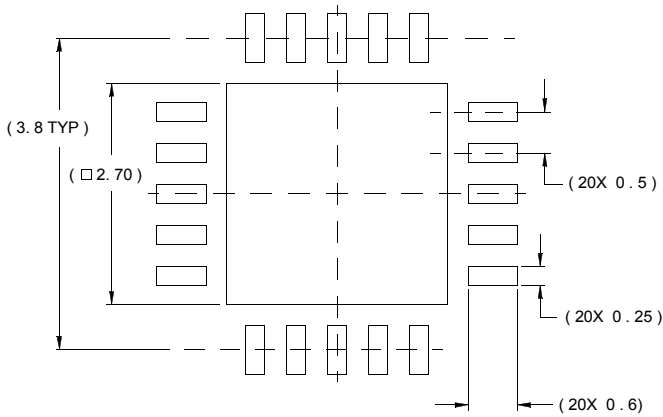

TYPICAL RECOMMENDED LAND PATTERN

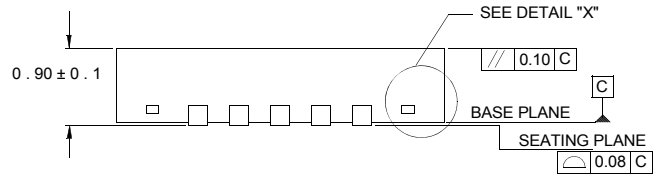

SIDE VIEW

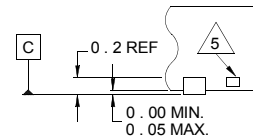

DETAIL "X"

NOTES:

1. Dimensions are in millimeters.
Dimensions in () for Reference Only.
2. Dimensioning and tolerancing conform to AMSE Y14.5m-1994.
3. Unless otherwise specified, tolerance : Decimal ± 0.05
4. Dimension b applies to the metallized terminal and is measured between 0.15mm and 0.30mm from the terminal tip.
5. Tiebar shown (if present) is a non-functional feature.
6. The configuration of the pin #1 identifier is optional, but must be located within the zone indicated. The pin #1 identifier may be either a mold or mark feature.

Notice

1. Descriptions of circuits, software and other related information in this document are provided only to illustrate the operation of semiconductor products and application examples. You are fully responsible for the incorporation or any other use of the circuits, software, and information in the design of your product or system. Renesas Electronics disclaims any and all liability for any losses and damages incurred by you or third parties arising from the use of these circuits, software, or information.
2. Renesas Electronics hereby expressly disclaims any warranties against and liability for infringement or any other claims involving patents, copyrights, or other intellectual property rights of third parties, by or arising from the use of Renesas Electronics products or technical information described in this document, including but not limited to, the product data, drawings, charts, programs, algorithms, and application examples.
3. No license, express, implied or otherwise, is granted hereby under any patents, copyrights or other intellectual property rights of Renesas Electronics or others.
4. You shall not alter, modify, copy, or reverse engineer any Renesas Electronics product, whether in whole or in part. Renesas Electronics disclaims any and all liability for any losses or damages incurred by you or third parties arising from such alteration, modification, copying or reverse engineering.
5. Renesas Electronics products are classified according to the following two quality grades: "Standard" and "High Quality". The intended applications for each Renesas Electronics product depends on the product's quality grade, as indicated below.
"Standard": Computers; office equipment; communications equipment; test and measurement equipment; audio and visual equipment; home electronic appliances; machine tools; personal electronic equipment; industrial robots; etc.
"High Quality": Transportation equipment (automobiles, trains, ships, etc.); traffic control (traffic lights); large-scale communication equipment; key financial terminal systems; safety control equipment; etc.
Unless expressly designated as a high reliability product or a product for harsh environments in a Renesas Electronics data sheet or other Renesas Electronics document, Renesas Electronics products are not intended or authorized for use in products or systems that may pose a direct threat to human life or bodily injury (artificial life support devices or systems; surgical implantations; etc.), or may cause serious property damage (space system; undersea repeaters; nuclear power control systems; aircraft control systems; key plant systems; military equipment; etc.). Renesas Electronics disclaims any and all liability for any damages or losses incurred by you or any third parties arising from the use of any Renesas Electronics product that is inconsistent with any Renesas Electronics data sheet, user's manual or other Renesas Electronics document.
6. When using Renesas Electronics products, refer to the latest product information (data sheets, user's manuals, application notes, "General Notes for Handling and Using Semiconductor Devices" in the reliability handbook, etc.), and ensure that usage conditions are within the ranges specified by Renesas Electronics with respect to maximum ratings, operating power supply voltage range, heat dissipation characteristics, installation, etc. Renesas Electronics disclaims any and all liability for any malfunctions, failure or accident arising out of the use of Renesas Electronics products outside of such specified ranges.
7. Although Renesas Electronics endeavors to improve the quality and reliability of Renesas Electronics products, semiconductor products have specific characteristics, such as the occurrence of failure at a certain rate and malfunctions under certain use conditions. Unless designated as a high reliability product or a product for harsh environments in a Renesas Electronics data sheet or other Renesas Electronics document, Renesas Electronics products are not subject to radiation resistance design. You are responsible for implementing safety measures to guard against the possibility of bodily injury, injury or damage caused by fire, and/or danger to the public in the event of a failure or malfunction of Renesas Electronics products, such as safety design for hardware and software, including but not limited to redundancy, fire control and malfunction prevention, appropriate treatment for aging degradation or any other appropriate measures. Because the evaluation of microcomputer software alone is very difficult and impractical, you are responsible for evaluating the safety of the final products or systems manufactured by you.
8. Please contact a Renesas Electronics sales office for details as to environmental matters such as the environmental compatibility of each Renesas Electronics product. You are responsible for carefully and sufficiently investigating applicable laws and regulations that regulate the inclusion or use of controlled substances, including without limitation, the EU RoHS Directive, and using Renesas Electronics products in compliance with all these applicable laws and regulations. Renesas Electronics disclaims any and all liability for damages or losses occurring as a result of your noncompliance with applicable laws and regulations.
9. Renesas Electronics products and technologies shall not be used for or incorporated into any products or systems whose manufacture, use, or sale is prohibited under any applicable domestic or foreign laws or regulations. You shall comply with any applicable export control laws and regulations promulgated and administered by the governments of any countries asserting jurisdiction over the parties or transactions.
10. It is the responsibility of the buyer or distributor of Renesas Electronics products, or any other party who distributes, disposes of, or otherwise sells or transfers the product to a third party, to notify such third party in advance of the contents and conditions set forth in this document.
11. This document shall not be reprinted, reproduced or duplicated in any form, in whole or in part, without prior written consent of Renesas Electronics.
12. Please contact a Renesas Electronics sales office if you have any questions regarding the information contained in this document or Renesas Electronics products.
(Note 1) "Renesas Electronics" as used in this document means Renesas Electronics Corporation and also includes its directly or indirectly controlled subsidiaries.
(Note 2) "Renesas Electronics product(s)" means any product developed or manufactured by or for Renesas Electronics.

(Rev.4.0-1 November 2017)



SALES OFFICES

Renesas Electronics Corporation

<http://www.renesas.com>

Refer to "<http://www.renesas.com/>" for the latest and detailed information.

Renesas Electronics America Inc.
1001 Murphy Ranch Road, Milpitas, CA 95035, U.S.A.
Tel: +1-408-432-8888, Fax: +1-408-434-5351

Renesas Electronics Canada Limited
9251 Yonge Street, Suite 8309 Richmond Hill, Ontario Canada L4C 9T3
Tel: +1-905-237-2004

Renesas Electronics Europe Limited
Dukes Meadow, Millboard Road, Bourne End, Buckinghamshire, SL8 5FH, U.K
Tel: +44-1628-651-700, Fax: +44-1628-651-804

Renesas Electronics Europe GmbH
Arcadiastrasse 10, 40472 Düsseldorf, Germany
Tel: +49-211-6503-0, Fax: +49-211-6503-1327

Renesas Electronics (China) Co., Ltd.
Room 1709 Quantum Plaza, No.27 ZhichunLu, Haidian District, Beijing, 100191 P. R. China
Tel: +86-10-8235-1155, Fax: +86-10-8235-7679

Renesas Electronics (Shanghai) Co., Ltd.
Unit 301, Tower A, Central Towers, 555 Langao Road, Putuo District, Shanghai, 200333 P. R. China
Tel: +86-21-2226-0888, Fax: +86-21-2226-0999

Renesas Electronics Hong Kong Limited
Unit 1601-1611, 16/F., Tower 2, Grand Century Place, 193 Prince Edward Road West, Mongkok, Kowloon, Hong Kong
Tel: +852-2265-6688, Fax: +852-2886-9022

Renesas Electronics Taiwan Co., Ltd.
13F, No. 363, Fu Shing North Road, Taipei 10543, Taiwan
Tel: +886-2-8175-9600, Fax: +886-2-8175-9670

Renesas Electronics Singapore Pte. Ltd.
80 Bendemeer Road, Unit #06-02 Hyflux Innovation Centre, Singapore 339949
Tel: +65-6213-0200, Fax: +65-6213-0300

Renesas Electronics Malaysia Sdn.Bhd.
Unit 1207, Block B, Menara Amcorp, Amcorp Trade Centre, No. 18, Jln Persiaran Barat, 46050 Petaling Jaya, Selangor Darul Ehsan, Malaysia
Tel: +60-3-7955-9390, Fax: +60-3-7955-9510

Renesas Electronics India Pvt. Ltd.
No.777C, 100 Feet Road, HAL 2nd Stage, Indiranagar, Bangalore 560 038, India
Tel: +91-80-67208700, Fax: +91-80-67208777

Renesas Electronics Korea Co., Ltd.
17F, KAMCO Yangjae Tower, 262, Gangnam-daero, Gangnam-gu, Seoul, 06265 Korea
Tel: +82-2-558-3737, Fax: +82-2-558-5338

X-ON Electronics

Largest Supplier of Electrical and Electronic Components

Click to view similar products for [Buffers & Line Drivers](#) category:

Click to view products by [Renesas](#) manufacturer:

Other Similar products are found below :

[LXV200-024SW](#) [74AUP2G34FW3-7](#) [HEF4043BP](#) [NLU1GT126CMUTCG](#) [PI74FCT3244L](#) [MC74HCT365ADTR2G](#) [Le87401NQC](#)
[Le87402MQC](#) [028192B](#) [042140C](#) [051117G](#) [070519XB](#) [NL17SZ07P5T5G](#) [NLU1GT126AMUTCG](#) [74AUP1G17FW5-7](#) [74LVC2G17FW4-7](#)
[CD4502BE](#) [5962-8982101PA](#) [5962-9052201PA](#) [74LVC1G125FW4-7](#) [NL17SH17P5T5G](#) [74HCT126T14-13](#) [NL17SH125P5T5G](#)
[NLV37WZ07USG](#) [RHRXH162244K1](#) [74AUP1G34FW5-7](#) [74AUP1G07FW5-7](#) [74LVC2G126RA3-7](#) [NLX2G17CMUTCG](#)
[74LVCE1G125FZ4-7](#) [Le87501NQC](#) [74AUP1G126FW5-7](#) [TC74HC4050AP\(F\)](#) [74LVCE1G07FZ4-7](#) [NLX3G16DMUTCG](#)
[NLX2G06AMUTCG](#) [NLU2G17AMUTCG](#) [LE87100NQC](#) [LE87100NQCT](#) [LE87285NQC](#) [LE87285NQCT](#) [LE87290YQC](#) [LE87290YQCT](#)
[LE87511NQC](#) [LE87511NQCT](#) [LE87557NQC](#) [LE87557NQCT](#) [LE87614MQC](#) [LE87614MQCT](#) [LE87286NQCT](#)